

Power MOSFET

200 mAmps, 50 Volts

N-Channel SC-70

Typical applications are dc-dc converters, power management in portable and battery-powered products such as computers, printers, PCMCIA cards, cellular and cordless telephones.

- Low Threshold Voltage ($V_{GS(th)}$: 0.5V...1.5V) makes it ideal for low voltage applications
- Miniature SC-70 Surface Mount Package saves board space
- Pb-Free Package May be Available. The G-Suffix Denotes a Pb-Free Lead Finish
- S- Prefix for Automotive and Other Applications Requiring Unique Site and Control Change Requirements; AEC-Q101 Qualified and PPAP Capable.

MAXIMUM RATINGS ($T_A = 25^\circ\text{C}$ unless otherwise noted)

| Rating | Symbol | Value | Unit |
|---|-----------------|-------------|--------------------|
| Drain-to-Source Voltage | V_{DSS} | 50 | Vdc |
| Gate-to-Source Voltage – Continuous | V_{GS} | ± 20 | Vdc |
| Drain Current | | | mA |
| – Continuous @ $T_A = 25^\circ\text{C}$ | I_D | 200 | |
| – Pulsed Drain Current ($t_p \leq 10 \mu\text{s}$) | I_{DM} | 800 | |
| Total Power Dissipation @ $T_A = 25^\circ\text{C}$ | P_D | 150 | mW |
| Operating and Storage Temperature Range | T_J, T_{stg} | - 55 to 150 | $^\circ\text{C}$ |
| Thermal Resistance – Junction-to-Ambient | $R_{\theta JA}$ | 556 | $^\circ\text{C/W}$ |
| Maximum Lead Temperature for Soldering Purposes, for 10 seconds | T_L | 260 | $^\circ\text{C}$ |

ORDERING INFORMATION

| Device | Marking | Shipping |
|------------------------------|---------|-------------------|
| LBSS138WT1G S-LBSS138WT1G | J1 | 3000 Tape & Reel |
| LBSS138WT3G S-LBSS138WT3G | J1 | 10000 Tape & Reel |

LBSS138WT1G

S-LBSS138WT1G

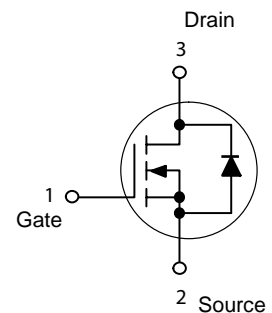
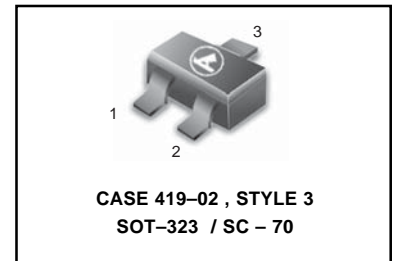

Marking Diagram

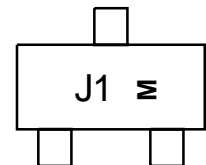

J1 = Device Code
M = Month Code

LBSS138WT1G , S-LBSS138WT1G

ELECTRICAL CHARACTERISTICS ($T_A = 25^\circ\text{C}$ unless otherwise noted)

| Characteristic | Symbol | Min | Typ | Max | Unit |
|----------------|--------|-----|-----|-----|------|
|----------------|--------|-----|-----|-----|------|

OFF CHARACTERISTICS

| | | | | | |
|---|---------------|--------|--------|------------|-----------------|
| Drain-to-Source Breakdown Voltage ($V_{GS} = 0 \text{ Vdc}$, $I_D = 250 \mu\text{Adc}$) | $V_{(BR)DSS}$ | 50 | – | – | Vdc |
| Zero Gate Voltage Drain Current ($V_{DS} = 25 \text{ Vdc}$, $V_{GS} = 0 \text{ Vdc}$) ($V_{DS} = 50 \text{ Vdc}$, $V_{GS} = 0 \text{ Vdc}$) | I_{DSS} | – – | – – | 0.1 0.5 | μAdc |
| Gate-Source Leakage Current ($V_{GS} = \pm 20 \text{ Vdc}$, $V_{DS} = 0 \text{ Vdc}$) | I_{GSS} | – | – | ± 0.1 | μAdc |

ON CHARACTERISTICS (Note 1.)

| | | | | | |
|--|--------------|--------|----------|-----------|-------|
| Gate-Source Threshold Voltage ($V_{DS} = V_{GS}$, $I_D = 1.0 \text{ mAdc}$) | $V_{GS(th)}$ | 0.5 | – | 1.5 | Vdc |
| Static Drain-to-Source On-Resistance ($V_{GS} = 2.75 \text{ Vdc}$, $I_D < 200 \text{ mAdc}$, $T_A = -40^\circ\text{C}$ to $+85^\circ\text{C}$) ($V_{GS} = 5.0 \text{ Vdc}$, $I_D = 200 \text{ mAdc}$) | $r_{DS(on)}$ | – – | 5.6 – | 10 3.5 | Ohms |
| Forward Transconductance ($V_{DS} = 25 \text{ Vdc}$, $I_D = 200 \text{ mAdc}$, $f = 1.0 \text{ kHz}$) | g_{fs} | 100 | – | – | mmhos |

DYNAMIC CHARACTERISTICS

| | | | | | | |
|----------------------|--|-----------|---|-----|-----|----|
| Input Capacitance | ($V_{DS} = 25 \text{ Vdc}$, $V_{GS} = 0$, $f = 1 \text{ MHz}$) | C_{iss} | – | 40 | 50 | pF |
| Output Capacitance | ($V_{DS} = 25 \text{ Vdc}$, $V_{GS} = 0$, $f = 1 \text{ MHz}$) | C_{oss} | – | 12 | 25 | |
| Transfer Capacitance | ($V_{DG} = 25 \text{ Vdc}$, $V_{GS} = 0$, $f = 1 \text{ MHz}$) | C_{rss} | – | 3.5 | 5.0 | |

SWITCHING CHARACTERISTICS (Note 2.)

| | | | | | | |
|---------------------|--|--------------|---|---|----|----|
| Turn-On Delay Time | ($V_{DD} = 30 \text{ Vdc}$, $I_D = 0.2 \text{ Adc}$,) | $t_{d(on)}$ | – | – | 20 | ns |
| Turn-Off Delay Time | | $t_{d(off)}$ | – | – | 20 | |

1. Pulse Test: Pulse Width $\leq 300 \mu\text{s}$, Duty Cycle $\leq 2\%$.
2. Switching characteristics are independent of operating junction temperature.

LBSS138WT1G , S-LBSS138WT1G

TYPICAL ELECTRICAL CHARACTERISTICS

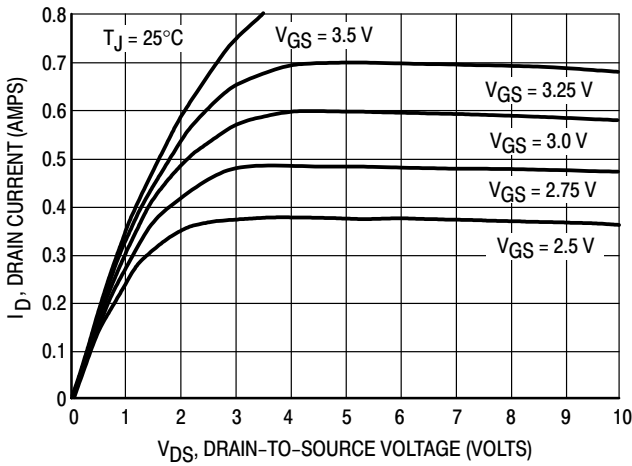

Figure 1. On-Region Characteristics

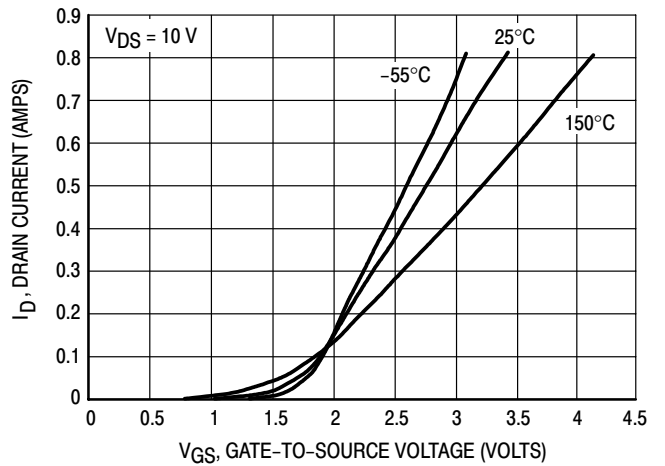

Figure 2. Transfer Characteristics

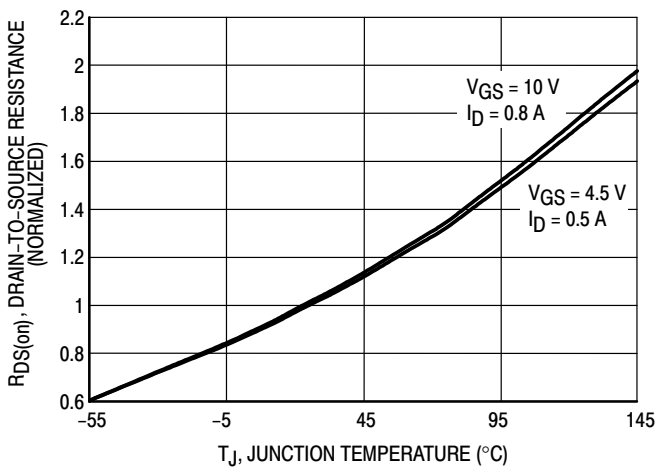

Figure 3. On-Resistance Variation with Temperature

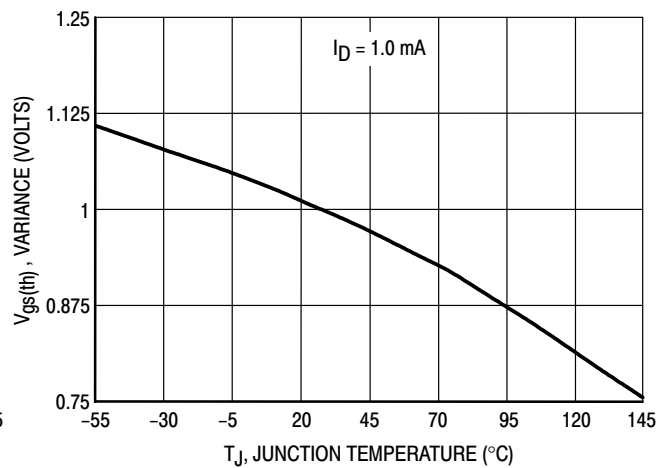

Figure 4. Threshold Voltage Variation with Temperature

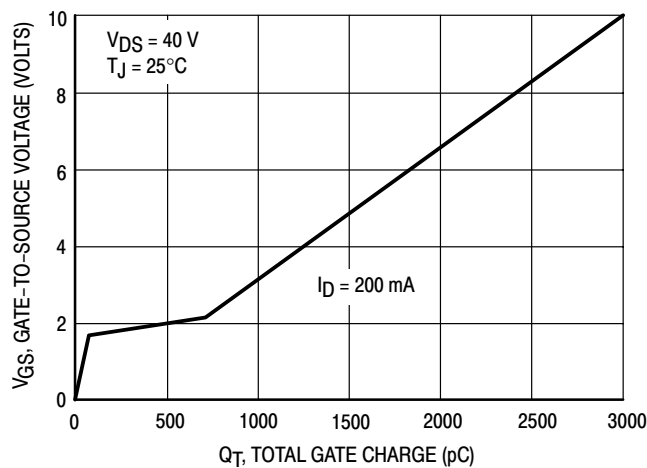

Figure 5. Gate Charge

LBSS138WT1G , S-LBSS138WT1G

TYPICAL ELECTRICAL CHARACTERISTICS

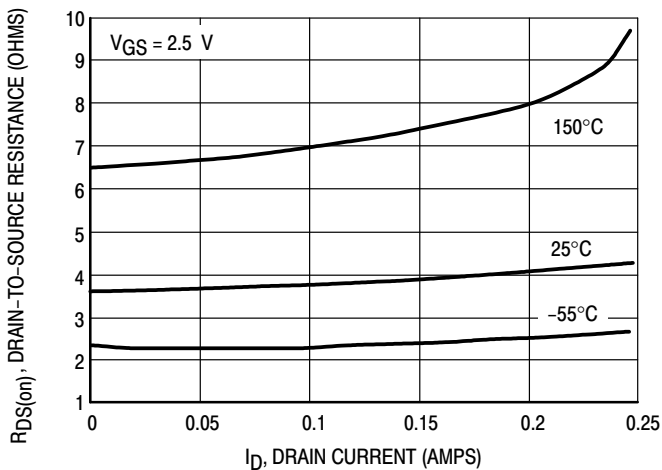

Figure 6. On-Resistance versus Drain Current

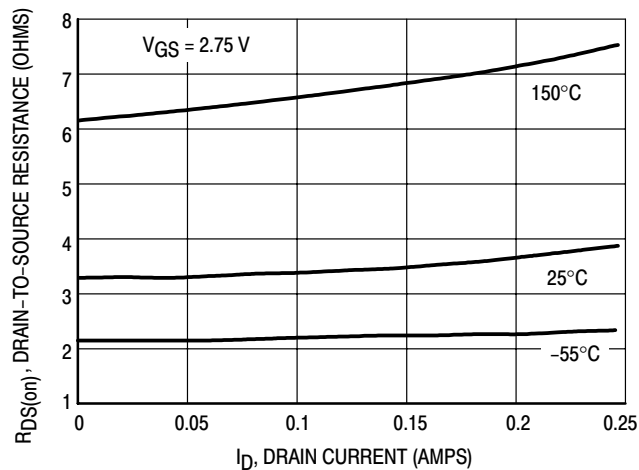

Figure 7. On-Resistance versus Drain Current

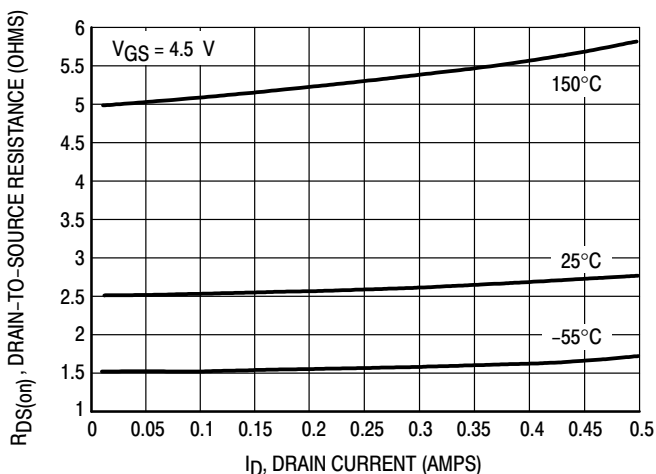

Figure 8. On-Resistance versus Drain Current

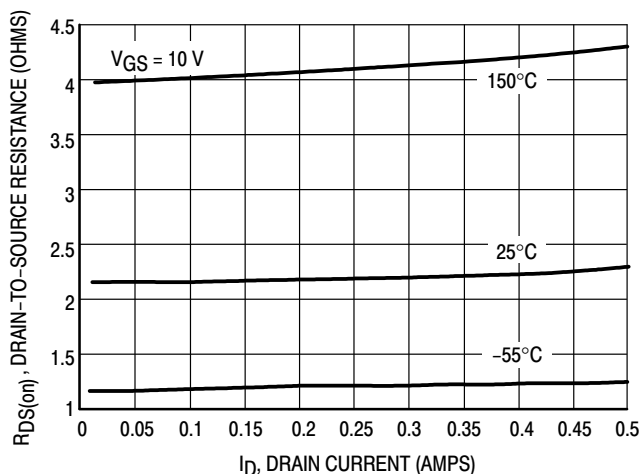

Figure 9. On-Resistance versus Drain Current

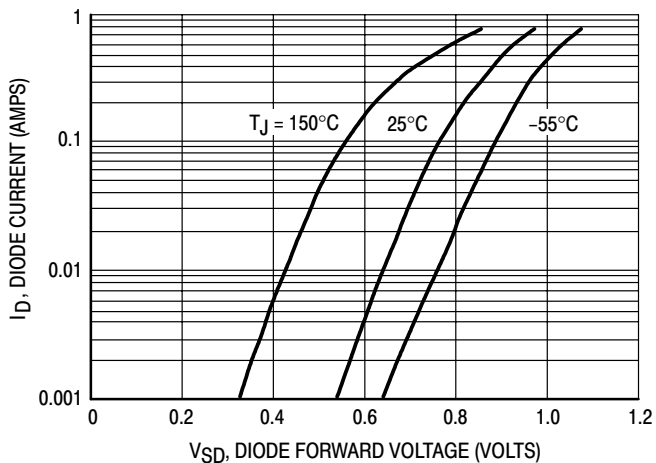

Figure 10. Body Diode Forward Voltage

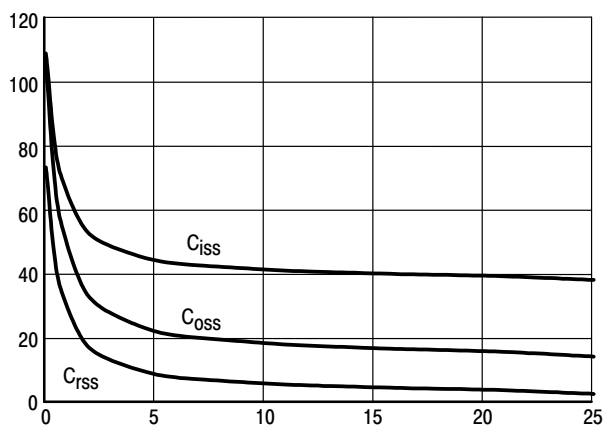

Figure 11. Capacitance

LBSS138WT1G , S-LBSS138WT1G

SC-70 / SOT-323

NOTES:

1. DIMENSIONING AND TOLERANCING PER ANSI Y14.5M, 1982.
2. CONTROLLING DIMENSION: INCH.

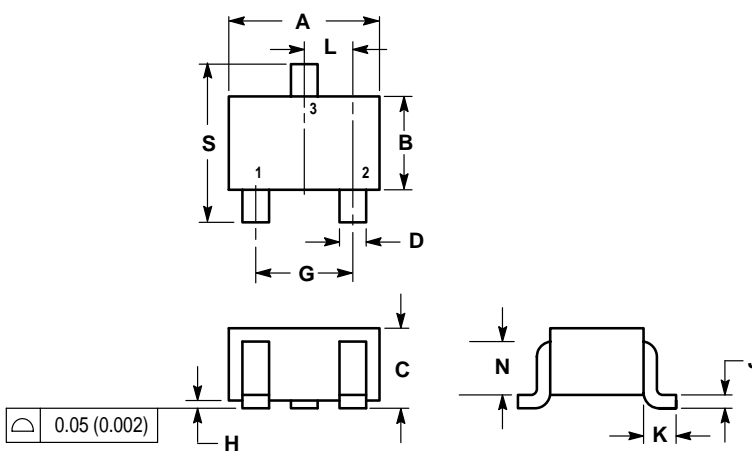

| DIM | INCHES | | MILLIMETERS | |
|-----|-----------|-------|-------------|------|
| | MIN | MAX | MIN | MAX |
| A | 0.071 | 0.087 | 1.80 | 2.20 |
| B | 0.045 | 0.053 | 1.15 | 1.35 |
| C | 0.032 | 0.040 | 0.80 | 1.00 |
| D | 0.012 | 0.016 | 0.30 | 0.40 |
| G | 0.047 | 0.055 | 1.20 | 1.40 |
| H | 0.000 | 0.004 | 0.00 | 0.10 |
| J | 0.004 | 0.010 | 0.10 | 0.25 |
| K | 0.017 REF | | 0.425 REF | |
| L | 0.026 BSC | | 0.650 BSC | |
| N | 0.028 REF | | 0.700 REF | |
| S | 0.079 | 0.095 | 2.00 | 2.40 |

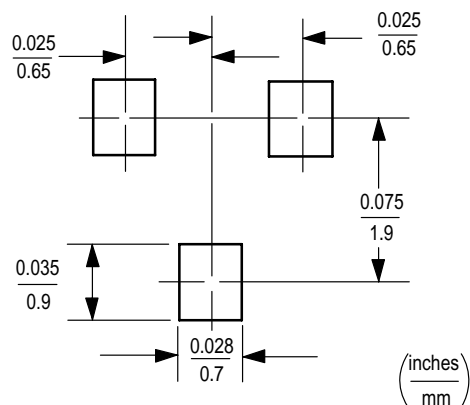

Tape & Reel and Packaging Specifications for Small-Signal Transistors, FETs and Diodes

Embossed Tape and Reel is used to facilitate automatic pick and place equipment feed requirements. The tape is used as the shipping container for various products and requires a minimum of handling. The antistatic/conductive tape provides a secure cavity for the product when sealed with the “peel-back” cover tape.

- Two Reel Sizes Available (7" and 13")
- Used for Automatic Pick and Place Feed Systems
- Minimizes Product Handling
- EIA 481, -1, -2
- SOT-23, SC-70/SOT-323, SC-89, SC-88/SOT-363, SC-88A/SOT-353, SOD-323, SOD-523 in 8 mm Tape

Use the standard device title and add the required suffix as listed in the option table below (Table 1). Note that the individual reels have a finite number of devices depending on the type of product contained in the tape. Also note the minimum lot size is one full reel for each line item, and orders are required to be in increments of the single reel quantity.

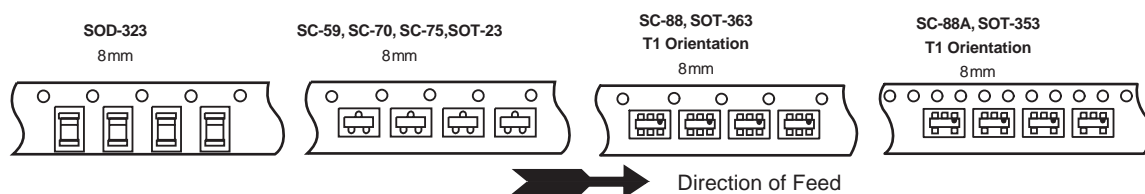

Typical Reel Orientations

Table 1. EMBOSSED TAPE AND REEL ORDERING INFORMATION

| Package | Tape Width (mm) | Pitch mm | Reel Size mm(inch) | Devices Per Reel and Minimum Order Quantity | Device Suffix |
|----------------|-----------------|----------|--------------------|---|---------------|
| SOT-23 | 8 | 4 | 178 | (7) | 3,000 T1 |
| | 8 | | 330 | (13) | 10,000 T3 |
| SC-70/SOT-323 | 8 | 4 | 178 | (7) | 3,000 T1 |
| | 8 | | 330 | (13) | 10,000 T3 |
| SC-89 | 8 | 4 | 178 | (7) | 3,000 T1 |
| | 8 | | 330 | (13) | 10,000 T3 |
| SC-88/SOT-363 | 8 | 4 | 178 | (7) | 3,000 T1 |
| | 8 | | 330 | (13) | 10,000 T3 |
| SC-88A/SOT-353 | 8 | 4 | 178 | (7) | 3,000 T1 |
| | 8 | | 330 | (13) | 10,000 T3 |
| SOD-323 | 8 | 4 | 178 | (7) | 3,000 T1 |
| | 8 | | 330 | (13) | 10,000 T3 |
| SOD-523 | 8 | 4 | 178 | (7) | 3,000 T1 |
| | 8 | | 330 | (13) | 10,000 T3 |

EMBOSSED TAPE AND REEL DATA FOR DISCRETES CARRIER TAPE SPECIFICATIONS

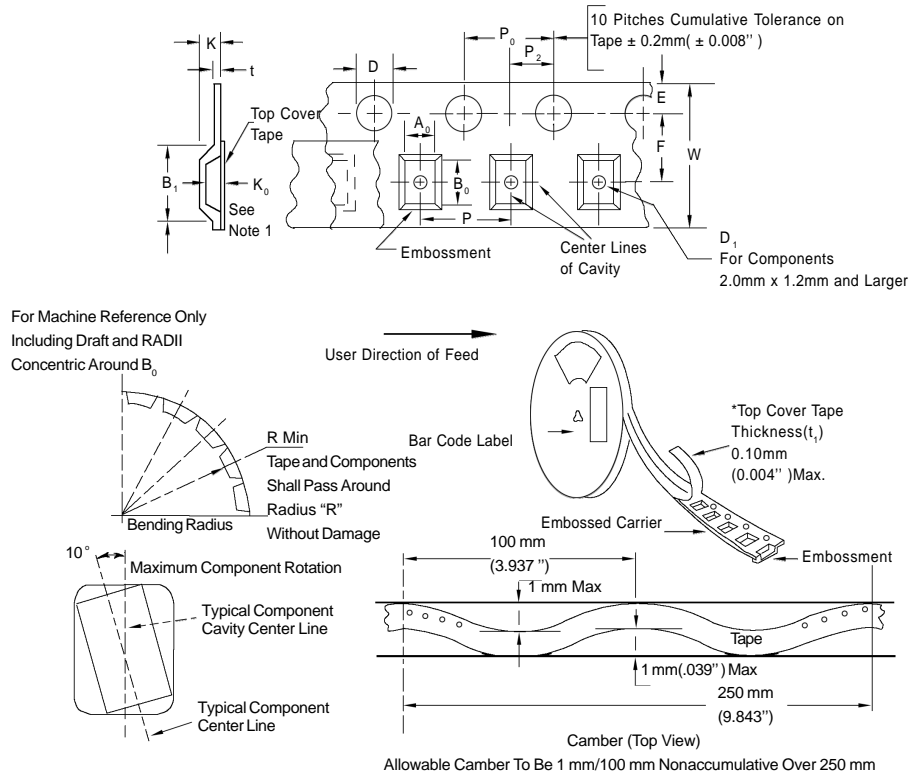

DIMENSIONS

| Tape Size | B_1 Max | D | D_1 | E | F | K | P_0 | P_2 | RMin | TMax | WMax |
|-----------|-------------------|-----------------------|---------------------|---------------------------|----------------------------|----------------------|---------------------------|---------------------------|-----------------|------------------|--------------------------|
| 8mm | 4.55mm (.179") | 1.5+0.1mm -0.0 | 1.0Min (.039") | 1.75±0.1mm (.069±.004) | 3.5±0.05mm (.138±.002") | 2.4mmMax (.094") | 4.0±0.1mm (.157±.004") | 2.0±0.1mm (.079±.002") | 25mm (.98") | 0.6mm (.024") | 8.3mm (.327") |
| 12mm | 8.2mm (.323") | (.059+0.004" -0.0) | 1.5mmMin (.060") | | 5.5±0.05mm (.217±.002") | 6.4mmMax (.252") | | | 30mm (1.18") | | 12±.30mm (.470±.012") |
| 16mm | 12.1mm (.476") | | | | 7.5±0.10mm (.295±.004") | 7.9mmMax (.311") | | | | | 16.3mm (.642") |
| 24mm | 20.1mm (.791") | | | | 11.5±0.1mm (.453±.004") | 11.9mmMax (.468") | | | | | 24.3mm (.957") |

Metric dimensions govern - English are in parentheses for reference only.

NOTE 1: A_0 , B_0 , and K_0 are determined by component size. The clearance between the components and the cavity must be within .05 mm min. to .50 mm max.,

NOTE 2: the component cannot rotate more than 10° within the determined cavity.

NOTE 3: If B_1 exceeds 4.2 mm (.165") for 8 mm embossed tape, the tape may not feed through all tape feeders.

EMBOSSED TAPE AND REEL DATA FOR DISCRETES

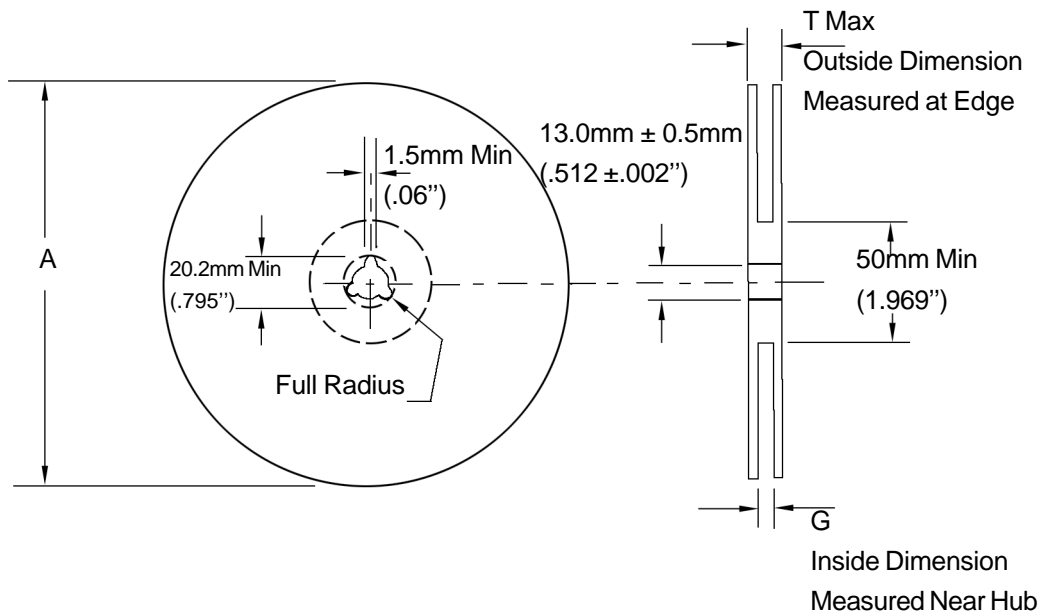

| Size | A Max | G | T Max |
|-------|--------------------|---|--------------------|
| 8 mm | 330mm (12.992") | 8.4mm+1.5mm, -0.0 (.33"+.059", -0.00) | 14.4mm (.56") |
| 12mm | 330mm (12.992") | 12.4mm+2.0mm, -0.0 (.49 "+ .079", -0.00) | 18.4mm (.72") |
| 16mm | 360mm (14.173") | 16.4mm+2.0mm, -0.0 (.646"+.078", -0.00) | 22.4mm (.882") |
| 24 mm | 360mm (14.173") | 24.4mm+2.0mm, -0.0 (.961"+.070", -0.00) | 30.4mm (1.197") |

Reel Dimensions

Metric Dimensions Govern — English are in parentheses for reference only

Storage Conditions

Temperature: 5 to 40 Deg.C (20 to 30 Deg. C is preferred)

Humidity: 30 to 80 RH (40 to 60 is preferred)

Recommended Period: One year after manufacturing

(This recommended period is for the soldering condition only. The characteristics and reliabilities of the products are not restricted to this limitation)