



Features

- ◇ For IF SAW filter
- ◇ High attenuation
- ◇ Single-ended operation
- ◇ Dual In-line Package
- ◇ RoHS compliant (2002/95/EC), Pb-free

www.DataSheet4U.com

Specifications

Parameter	Unit	Minimum	Typical	Maximum
Center Frequency	MHz	159.92	160	160.08
Insertion Loss	dB	22	23	26
3 dB Bandwidth	MHz	9.9	9.96	10.3
40dB Bandwidth	MHz	-	11.29	11.35
50 dB Bandwidth	MHz	-	11.42	12
Passband Variation	dB	-	0.8	1
Absolute Delay	usec	-	3	3.5
Group Delay Variation($f_0 \pm 4.5\text{MHz}$)	nsec	-	75	300
Ultimate Rejection	dB	50	60	-
Material Temperature coefficient	KHz/°C	-2.88		
Substrate Material	-	112LT		
Ambient Temperature	°C	25		
Operating Temperature Range	°C	-40	-	+85
Storage Temperature Range	°C	-45	-	+105
DC Voltage	V	0		
Input Power	dBm	-	-	10
ESD Class	-	1A		
Package Size	DIP2212 (22.2x12.8x4.7mm3)			

Notes:

1. All specifications are based on the test circuit shown;
2. In production, all specifications are measured by Agilent Network analyzer and full 2 port calibration at room temperature;
3. Electrical margin has been built into the design to account for the variations due to temperature drift and manufacturing tolerances;
4. This is the optimum impedance in order to achieve the performance show.

	SIPAT Co., Ltd. (CETC No.26 Research Institute) #14 Nanping Huayuan Road, Chongqing, China, 400060	Part Number	LBT16048	
		Rev. Date	2008-03-04	
		Ver.	1.0	Page

Matching Configuration

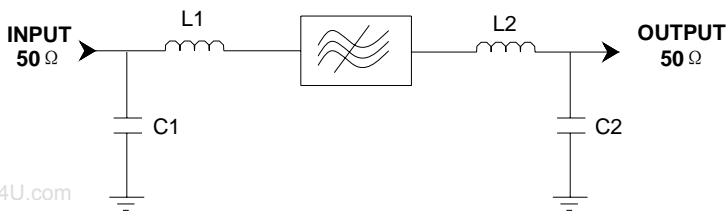

L1=L2=39nH
C1=27pF C2=36pF
Source/Load Impedance=50 ohm

Notes - Component values may change depending on board layout.

Package Dimension

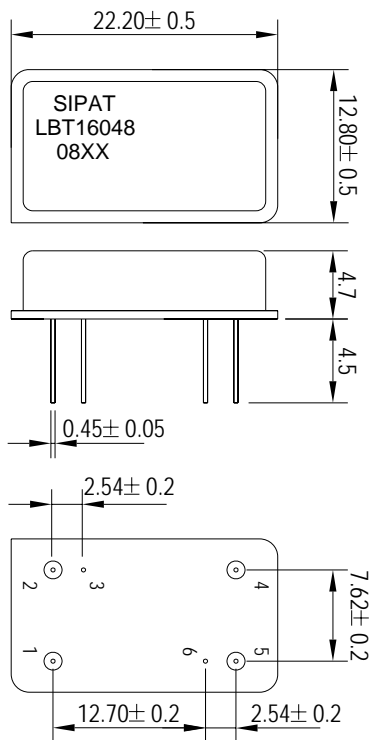

Pad Configuration:

Input 1
Output 5
Ground All Others

Marking Configuration:

1) SIPAT: Manufacturer Name
2) LBT16048: Part Number
3) 08XX: Date Code

Package: DIP2212

Unit: mm



SIPAT Co., Ltd.
(CETC No.26 Research Institute)
#14 Nanping Huayuan Road,
Chongqing, China, 400060

Part Number	LBT16048	
Rev. Date	2008-03-04	
Ver.	1.0	Page 2/3

Typical Performance

Frequency Respond

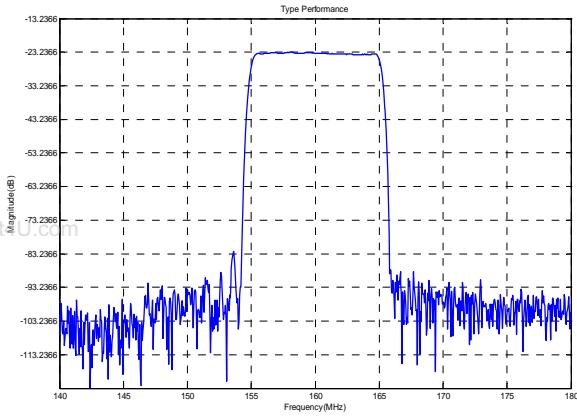

Horizontal: 5MHz/Div Vertical: 10dB/Div

Passband Respond

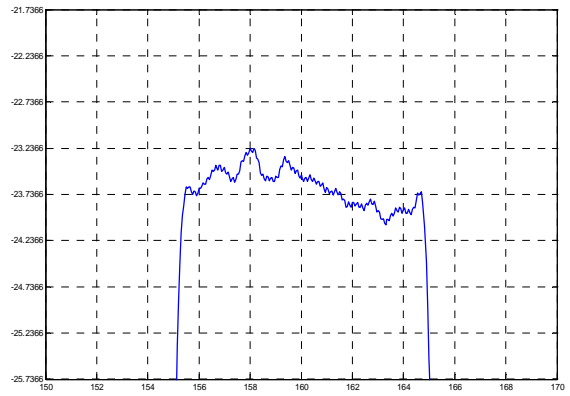

Horizontal: 2MHz/Div Vertical: 0.5dB/Div

Group Delay Variation(f0±4.5MHz)

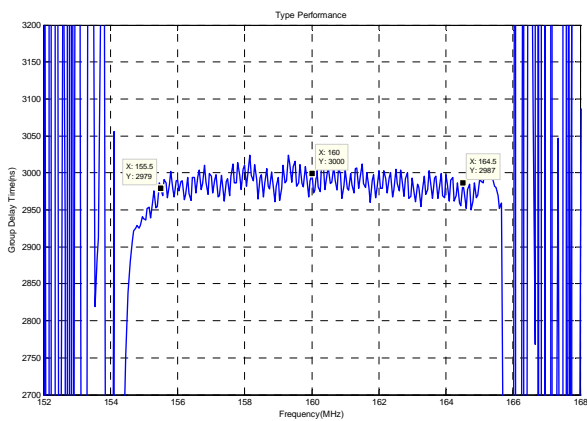

Horizontal: 2MHz/Div Vertical: 50ns/Div

Phase Linearity(f0±4.5MHz)

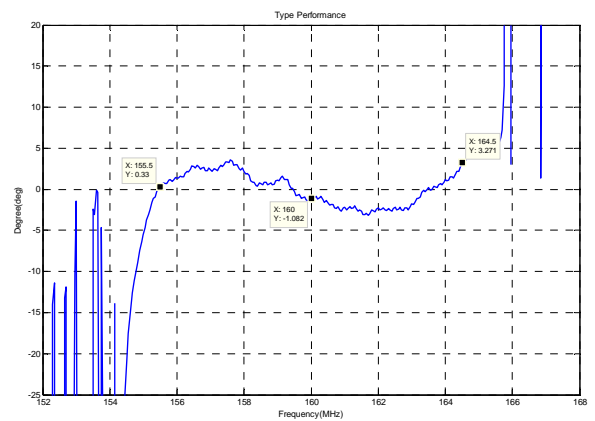

Horizontal: 2MHz/Div Vertical: 5deg/Div

Smith Chart S11

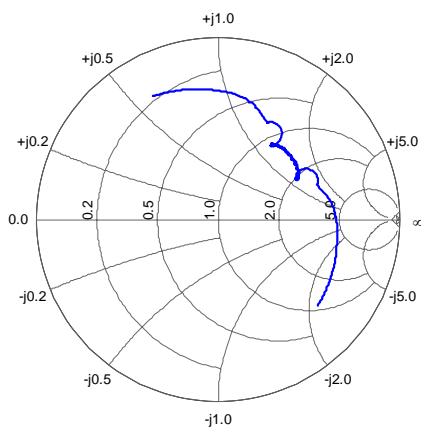

Smith Chart S22

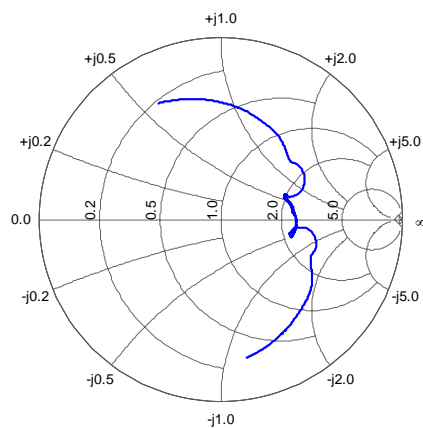

SIPAT Co., Ltd.
(CETC No.26 Research Institute)
#14 Nanping Huayuan Road,
Chongqing, China, 400060

Part Number	LBT16048	
Rev. Date	2008-03-04	
Ver.	1.0	Page 3/3