

GENERAL DESCRIPTION

LC1206 series are a group of positive voltage output, high precise, and high PSRR and low power consumption voltage regulator. Voltages are selectable in 100mV steps within a range of 1.2V to 3.6V. It also can be customized on command.

LC1206 series have excellent load and line transient response and good temperature characteristics, which can assure the stability of chip and power system. And it uses trimming technique to guarantee output voltage accuracy within $\pm 2\%$.

LC1206 series are available in SOT-23-3, SOT-23-5 and SOT-89-3 packages, which are lead (Pb)- free.

FEATURES

- Low Quiescent Current: 2uA at 5V
- 60dB PSRR at 100Hz
- Low Output Noise: 44uVRMS
- Low Dropout: 280mV at 150mA load
- Low Temperature Coefficient: $\pm 100\text{ppm}/^\circ\text{C}$
- Excellent Line Regulation: 0.05%/V
- Highly Accurate: $\pm 2\%$

APPLICATIONS

- Reference Voltage Source
- Battery Powered Equipment
- Hand-Hold Equipment
- Wireless LAN
- GPS Receivers

TYPICAL APPLICATION

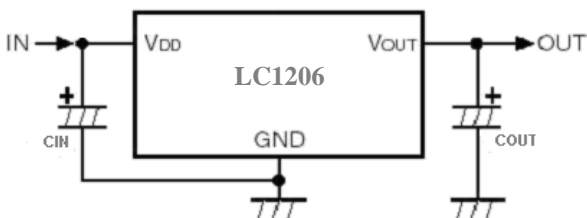

BLOCK DIAGRAM

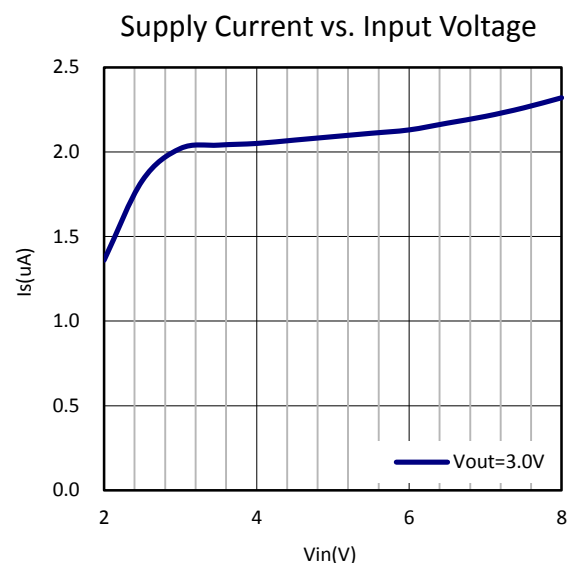
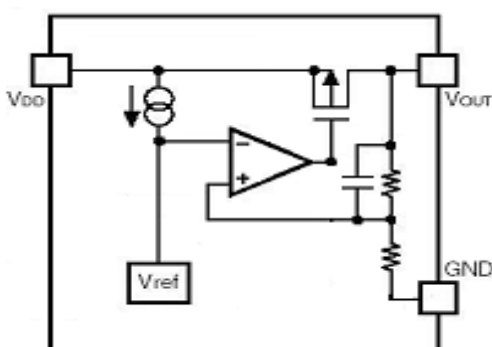

ORDERING INFORMATION

LC1206 1234

Code	Description
1	Temperature & Rohs: C: -40~85°C, Pb Free Rohs Std.
2	Package type: B3: SOT-23-3 B5: SOT-23-5 C3: SOT-89-3
3	Packing type: TR:Tape&Reel (Standard)
4	Output voltage: e.g. 12=1.2V 25=2.5V 36=3.6V

MARKING DESCRIPTON

E: Product Code

X: Output Voltage Code

VOUT	Code	VOUT	Code	VOUT	Code
1.2V	2	2.1V	1	3.0V	0
1.3V	3	2.2V	2	3.1V	1
1.4V	4	2.3V	3	3.2V	2
1.5V	5	2.4V	4	3.3V	3
1.6V	6	2.5V	5	3.4V	4
1.7V	7	2.6V	6	3.5V	5
1.8V	8	2.7V	7	3.6V	6
1.9V	9	2.8V	8		
2.0V	0	2.9V	9		

XX: Output voltage:

e.g. 12=1.2V, 25=2.5V, 36=3.6V.

Y: The Year of manufacturing, "1" stands for year 2011, "2" stands for year 2012, and "8" stands for year 2018.

W: The week of manufacturing. "A" stands for week 1, "Z" stands for week 26, "A" stands for week 27, "Z" stands for week 52.

MARKING INFORMATION

Product Classification		LC1206CB3TR□□
Marking		SOT-23-3
EXYW	E: Product Code	
	X: Output Voltage	
	YW: Date Code	
Product Classification		LC1206CB5TR□□
Marking		SOT-23-5
EXYW	E: Product Code	
	X: Output Voltage	
	YW: Date Code	
Product Classification		LC1206CC3TR□□
Marking		SOT-89-3
AFXX LLBYW	AF: Product Code	
	XX: Output Voltage	
	LL: LOT NO.	
	B: FAB Code	
	YW: Date Code	
GND	Ground	
VOUT	Output Voltage	
VDD	Supply Voltage Input	

ABSOLUTE MAXIMUM RATING

Parameter		Value
Max Input Voltage		10V
Operating Junction Temperature (TJ)		125°C
Ambient Temperature (TA)		-40°C~85°C
Power Dissipation	SOT-23-3, SOT-23-5	250mW
	SOT-89-3	500mW
Storage Temperature (TS)		-40°C~150°C
Lead Temperature & Time		260°C, 10 Sec

Note:

Exceed these limits to damage to the device.

Exposure to absolute maximum rating conditions may affect device reliability.

RECOMMENDED WORK CONDITIONS

Parameter	Value
Input Voltage Range	Max. 8V
Ambient Temperature	-40°C~85°C

ELECTRICAL CHARACTERISTICS

Test Conditions: C_{IN}=1uF, C_{OUT}=1uF, T_A=25°C, unless otherwise specified.

Symbol	Parameter	Conditions	Min	Typ	Max	Units	
VDD	Input Voltage				8	V	
VOUT	Output Voltage	VOUT > 1.5V	VDD=Set VOUT+1V 1mA ≤ IOUT ≤ 10mA	VOUT X0.98	VOUT	VOUT X1.02	V
		VOUT ≤ 1.5V		VOUT- 0.03	Vout	VOUT+ 0.03	V
IOUT (Max.) (Note 4)	Maximum Output Current	VDD-VOUT=1V	300			mA	
VDROP	Dropout Voltage	IOUT=150mA VOUT=3.0V		280		mV	
$\frac{\Delta V_{out}}{\Delta V_{in} \cdot V_{out}}$	Line Regulation	IOUT=10mA 4V ≤ VDD ≤ 6V		0.05	0.2	%/V	
ΔV_{out}	Load Regulation	VDD=Set VOUT+1V 1mA ≤ IOUT ≤ 300mA		150		mV	
Is	Supply Current	VDD=Set VOUT+1V VOUT Floating		2	3	uA	
$\frac{\Delta V_{out}}{\Delta T \cdot V_{out}}$	Output Voltage Temperature Coefficient	IOUT=10mA		± 100		ppm/°C	
PSRR	Ripple Rejection	f=100Hz, Ripple=0.5Vp-p, VDD=Set VOUT+1V		60		dB	
en	Output Noise	BW=10Hz~100KHz		44		uVrms	

Note:

The maximum power rating of each package is a constant, so along with the change of ILOAD, the VDD-VOUT should be controlled to a certain range to ensure the normal operation.

TYPICAL PERFORMANCE CHARACTERISTICS

Supply Current vs. Input Voltage

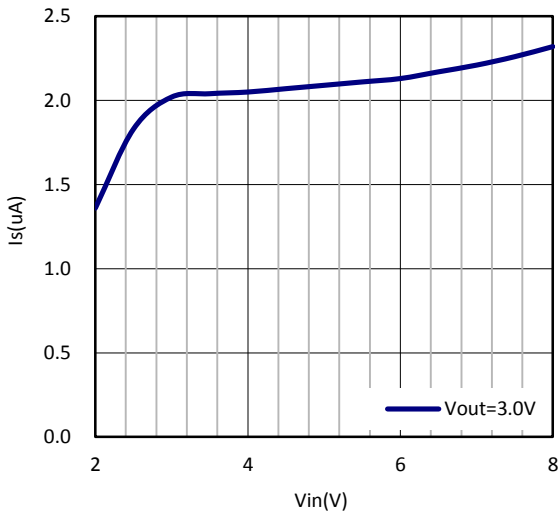

PSRR

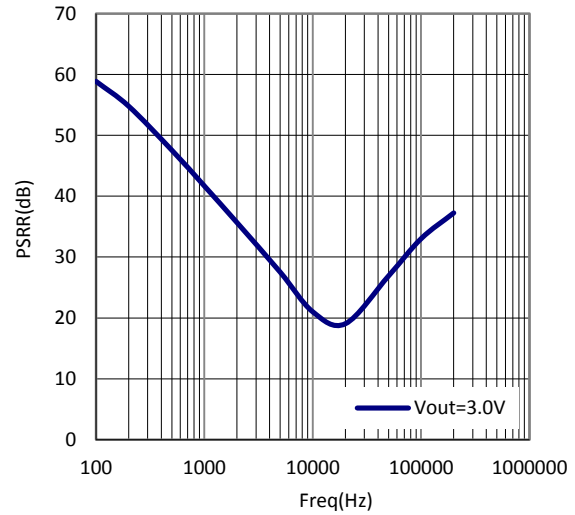

Output Voltage vs. Input Voltage

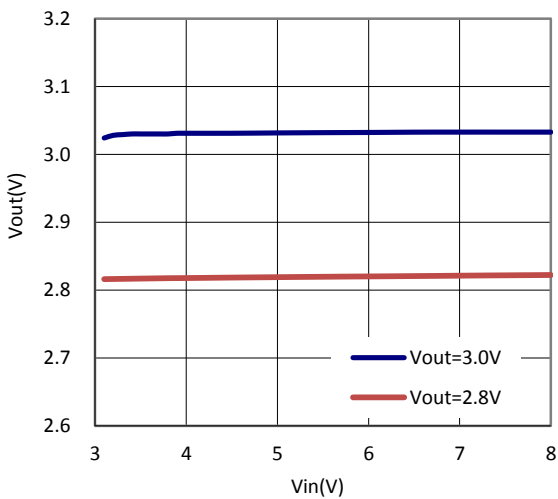

Dropout Voltage vs. Output Current

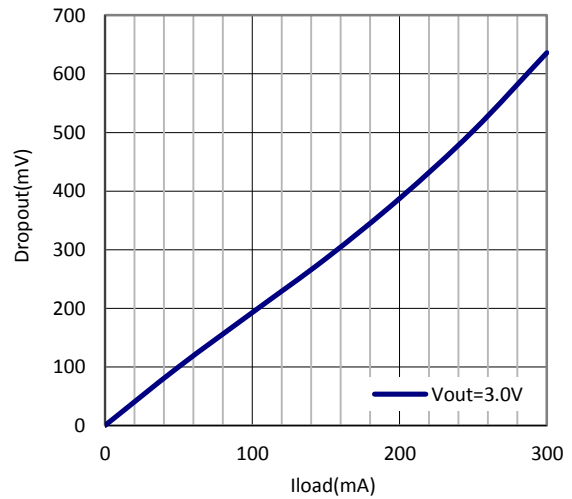

Output Voltage vs. Temperature

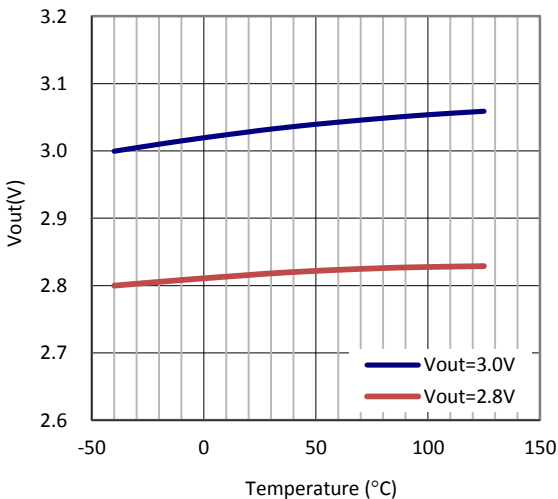

TEST WAVEFORMS

Line Transient Response
 $C_{IN}=C_{OUT}=1\mu F$, $V_{IN}=4\leftrightarrow 5V$, $V_{OUT}=3V$
 Ch1: Input Voltage, Ch2: Output Voltage

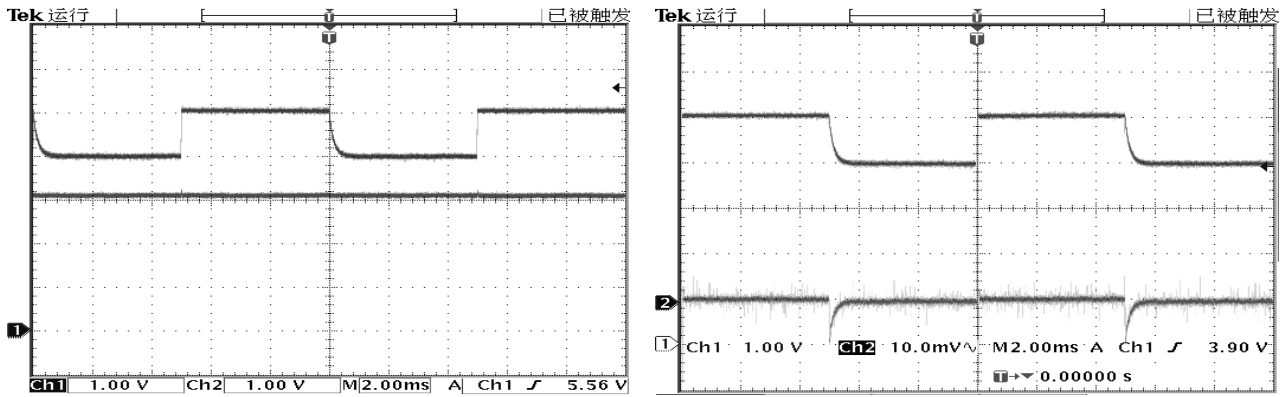

Load Transient Response
 $C_{IN}=C_{OUT}=1\mu F$, $I_{OUT}=1\leftrightarrow 100mA$, $V_{OUT}=3V$
 Ch1: Output Current, Ch2: Output Voltage

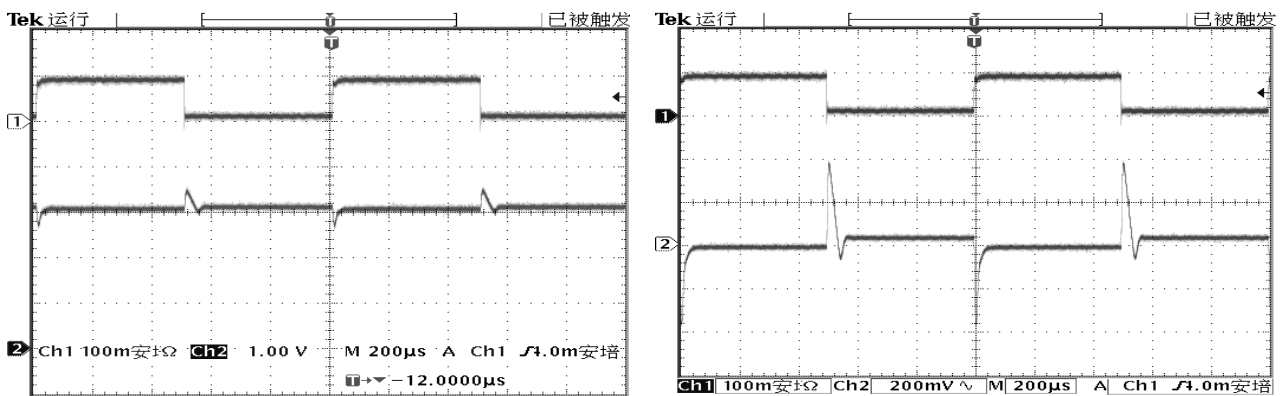

PACKAGE LINE

Package	SOT23-3	Devices per reel	3000Pcs	Unit	mm
Package dimension:					
<p>Technical drawing of the SOT23-3 package. It includes three views: a top view, a side view, and a cross-sectional view. Dimensions are provided in millimeters with tolerances. Key dimensions include: total length 2.400 ± 0.05, body length 1.300 ± 0.05, lead length 0.550 ± 0.05, lead width 0.400 ± 0.03, body width 1.900 ± 0.05, and lead width 0.400 ± 0.05. Radii are specified as 4 × R0.1 MAX. The cross-sectional view shows a lead height of 0.080 ± 0.02, a lead thickness of 0.100^{+0.05}/_{-0.01}, and a lead angle of 2 × 7°. Other features include a 0.2 MIN. lead thickness at the base and R0.08 fillets.</p>					

Package	SOT-23-5	Devices per reel	3000Pcs	Unit	mm
Package Dimension:					
<p>Technical drawing of the SOT-23-5 package. It includes three views: a top view, a side view, and a perspective view. Dimensions are provided in millimeters with tolerances. Key dimensions include: total length 2.9 ± 0.2, body length 1.9 ± 0.2, lead length 0.4 ± 0.1, body width 1.6^{+0.2}/_{-0.1}, and total height 2.8 ± 0.3. Lead widths are 0.95 mm. Lead heights are 1.1^{+0.2}/_{-0.1} mm and 0.8 ± 0.1 mm. Lead thickness is 0.15^{+0.1}/_{-0.05} mm. Lead angle is 0 to 0.1°. A 0.2 MIN. lead thickness is also indicated. The perspective view shows five leads labeled 1 through 5.</p>					

PACKAGE LINE (Continued)

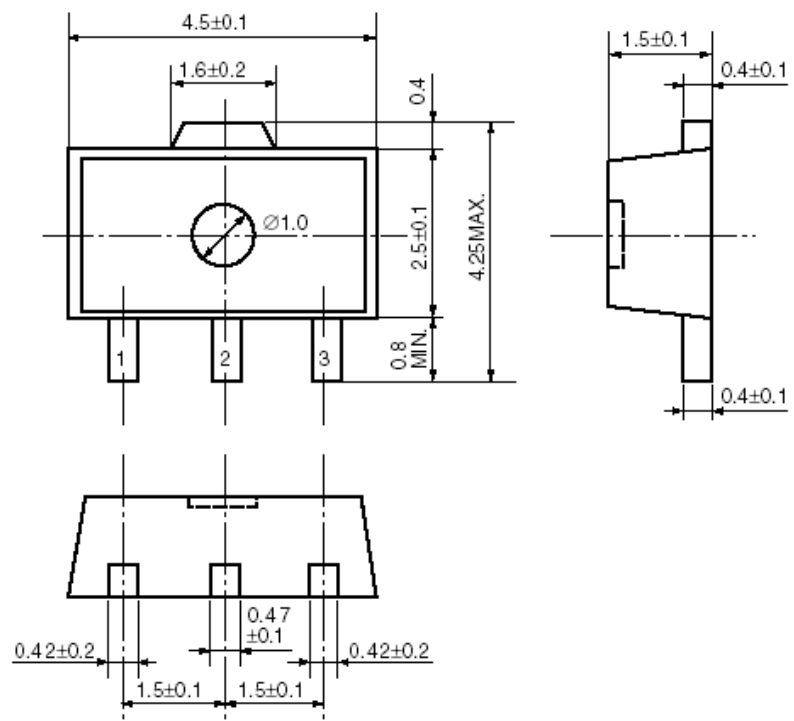
Package	SOT-89-3	Devices per reel	1000Pcs	Unit	mm
Package Dimension:  <p> The technical drawing illustrates the SOT-89-3 package dimensions in millimeters. The top view shows a rectangular body with a width of 4.5 ± 0.1 mm and a length of 2.5 ± 0.1 mm. A central circular feature has a diameter of $\varnothing 1.0$ mm. Three leads are attached to the bottom, with a lead width of 1.6 ± 0.2 mm and a lead height of 0.4 mm. The lead pitch is 1.5 ± 0.1 mm, and the lead thickness is 0.8 mm MIN. The side view shows a maximum height of 4.25 mm MAX. The bottom view shows a lead width of 0.42 ± 0.2 mm and a lead spacing of 1.5 ± 0.1 mm. A central feature on the bottom has a diameter of 0.47 ± 0.1 mm. </p>					