



# LC1215

## 16V 500mA Low Consumption Linear Regulator

### DESCRIPTION

LC1215 series is a group of positive voltage output, low power consumption, low dropout voltage regulator. It can provide 300mA output current when input / output voltage differential drops to 600mV ( $V_{out}=3.3V$ ), and it also provides foldback short-circuit protection, thermal protection and output current limit function. The very low power consumption of LC1215 ( $I_q=10\mu A$ ) can greatly improve natural life of batteries.

LC1215 can provide output value in the range of 1.2V~5.0V in 0.1V steps. It also can customize on command.

LC1215 includes high accuracy voltage reference, error amplifier, current limit circuit and output driver module.

LC1215 has well load transient response and good temperature characteristic, And it uses trimming technique to guarantee output voltage accuracy within  $\pm 2\%$ .

### TYPICAL APPLICATION

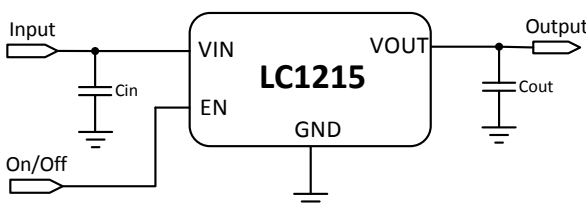

**NOTE:** Input capacitor ( $C_{in}=1\mu F$ ) and Output capacitor ( $C_{out}=1\mu F$ ) are recommended in all application circuit. Ceramic capacitor is recommended.

### FEATURES

- Low Power Consumption: 10 $\mu A$ (Typ.)
- Maximum Output Current: 500mA
- Small Dropout Voltage  
 600mV@300mA ( $V_{out}=3.3V$ )  
 1.2V@500mA ( $V_{out}=3.3V$ )
- Input Voltage Range: 3V~16V
- Output Voltage Range: 1.2V~5.0V (customized on command in 0.1V steps)
- Highly Accurate:  $\pm 2\%$  ( $\pm 1\%$  customized)
- Output Current Limit: 650mA

### APPLICATIONS

- Battery Powered equipment
- Power Management of MP3、PDA、DSC、Mouse、PS2 Games
- Reference Voltage Source Regulation after Switching Power

### ELECTRICAL CHARACTERISTICS

Load Regulation

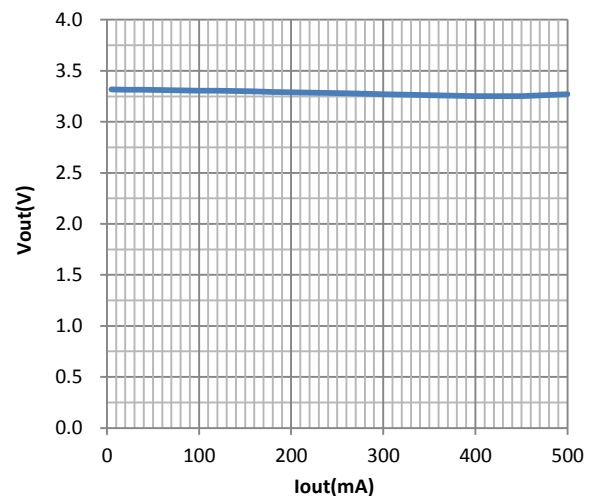

## ORDERING INFORMATION

LC1215 ①②③④⑤

Code	Description
①	Temperature&Rohs: C:-40~85°C ,Pb Free Rohs Std.
②	Package type: B5:SOT-23-5 C3:SOT-89-3
③	Packing type: TR:Tape&Reel (Standard)
④	Output voltage: e.g. 12=1.2V 15=1.5V 50=5.0V
⑤	Voltage accuracy: 1= ± 1% Blank(default)= ± 2%

## ABSOLUTE MAXIMUM RATING

Parameter	Value	
Max Input Voltage	20V	
Operating Junction Temperature(Tj)	125°C	
Ambient Temperature(Ta)	-40°C -85°C	
Power Dissipation (P <sub>D</sub> @Ta=25°C)	SOT-23-5	400mW
	SOT-89-3	500mW
Storage Temperature(Ts)	-40°C -150°C	
Lead Temperature & Time	260°C,10S	

### Note:

Exceed these limits to damage to the device.  
Exposure to absolute maximum rating conditions may affect device reliability.

## PIN CONFIGURATION

Product Classification		LC1215CB5TR□□□
Marking		SOT-23-5
PXYW	P:Product Code	
	X:Output Voltage	
	YW:Date Code	
Product Classification		LC1215CC3TR□□□
Marking		SOT-89-3
PXX LLXYW	P:Product Code	
	XX:Output Voltage	
	LL:LOT NO.	
	X:FAB Code	
	YW:Date Code	

Y: The Year of manufacturing, "1" stands for year 2011, "2" stands for year 2012, and "8" stands for year 2018.  
W: The week of manufacturing. "A" stands for week 1, "Z" stands for week 26, "A" stands for week 27, "Z" stands for week 52.

## RECOMMENDED WORK CONDITIONS

Item	Min	Recom- mended	Max.	Unit
Input Voltage Range	3		16	V
Ambient Temperature	-40		85	°C

## ELECTRICAL CHARACTERISTICS

(Test Conditions:  $C_{in}=1\mu F$ ,  $C_{out}=1\mu F$ ,  $T_a=25^\circ C$ , Unless Otherwise Specified)

Symbol	Parameter	Conditions	Min	Type	Max	Units
$V_{in}$	Input Voltage		3		16	V
$V_{out}$	Output Voltage	$V_{out}>1.5V$	$V_{in}-V_{out}=1.2V$ $1mA \leq I_{out} \leq 30mA$	Vout	$V_{out} \times 0.98$	V
		$V_{out} \leq 1.5V$			$V_{out} - 0.03$	
$I_{out(Max.)}$	Maximum Output Current	$V_{in}-V_{out}=1.2V$	500			mA
Dropout Voltage	Input-Output Voltage Differential	$I_{out}=300mA$ , $V_{out} = 3.3V$		600		mV
$\frac{\Delta V_{out}}{\Delta V_{in} \cdot V_{out}}$	Line Regulation	$I_{out}=10mA$ , $4V \leq V_{in} \leq 16V$		0.2	0.3	%/V
$\Delta V_{out}$	Load Regulation	$V_{in} = \text{Set } V_{out} + 1V$ $1mA \leq I_{out} \leq 100mA$		20	40	mV
$I_q$	Quiescent Current	$V_{in} = \text{Set } V_{out} + 1V$		10	20	$\mu A$
$\frac{\Delta V_{out}}{\Delta T \cdot V_{out}}$	Output Voltage Temperature Coefficient	$I_{out}=10mA$		$\pm 100$		ppm/ $^\circ C$
$V_{enh}$	EN Input Voltage "H"		1.5		$V_{in}$	V
$V_{enl}$	EN Input Voltage "L"		0		0.4	V
	Thermal Shutdown			150		$^\circ C$

## BLOCK DIAGRAM

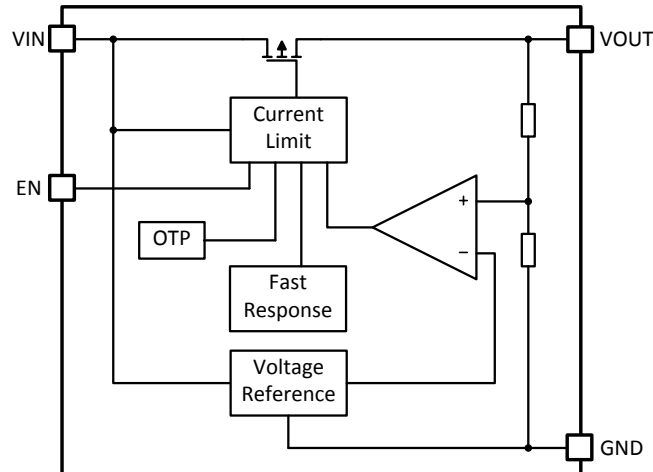

## EXPLANATION

LC1215 is a series of low dropout voltage and low power consumption regulator. Its application circuit is very simple, which only needs two outside capacitors. It is composed of these modules: high accuracy voltage reference, current limit circuit, error amplifier, output driver and power transistor.

Current Limit module can keep chip and power system away from danger when load current is more than 500mA.

LC1215 uses trimming technique to assure the accuracy of output value within  $\pm 2\%$ , at the same time, temperature compensation is elaborately considered in this chip, which makes LC1215's temperature coefficient within  $\pm 100\text{ppm}/^\circ C$ .

## TYPICAL PERFORMANCE CHARACTERISTICS

### Load Regulation

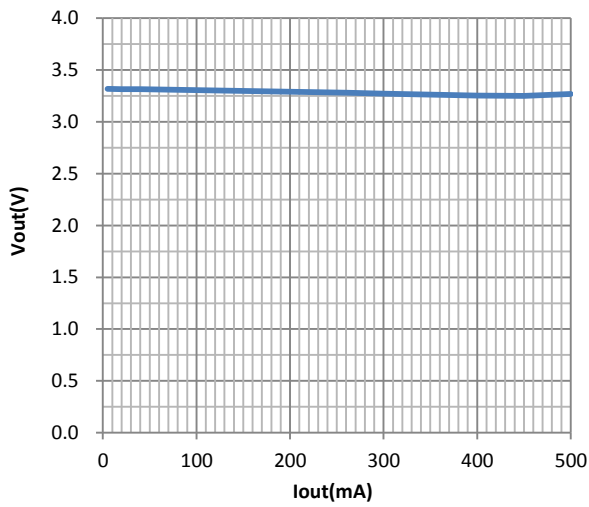

### Line Regulation

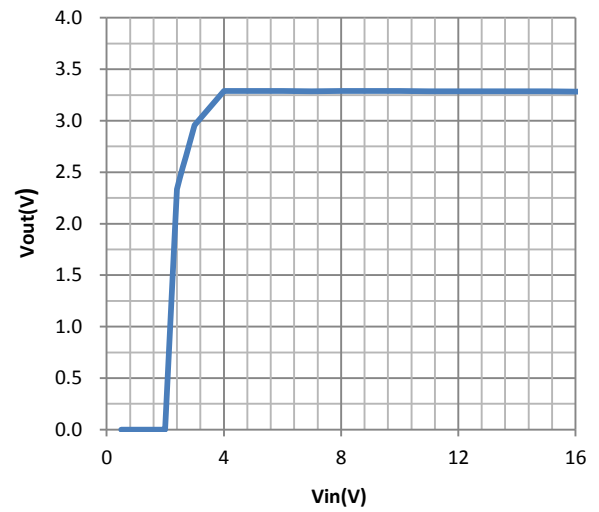

### Dropout

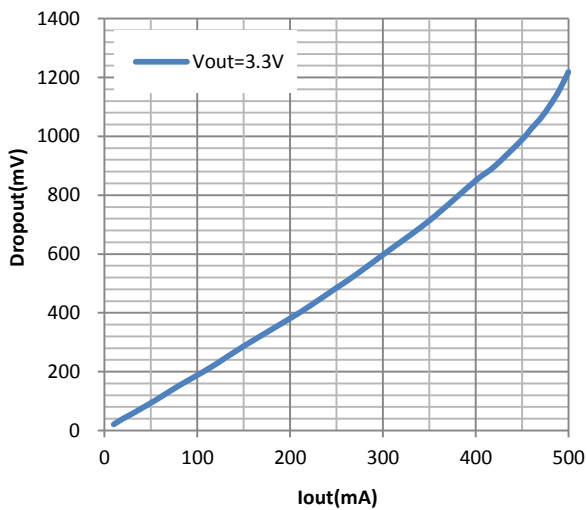

### Iq

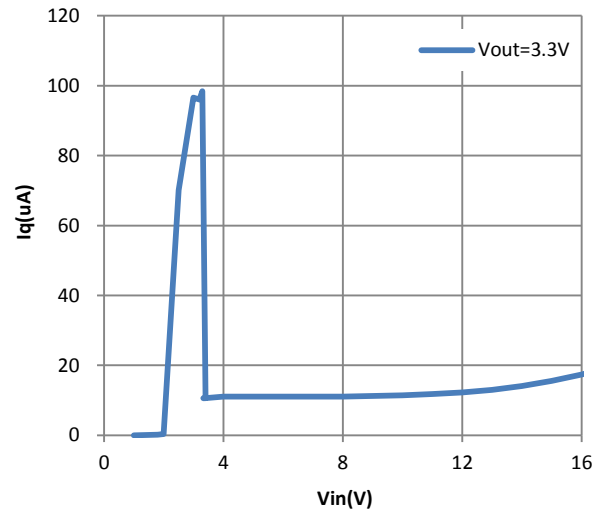

### Current Limit

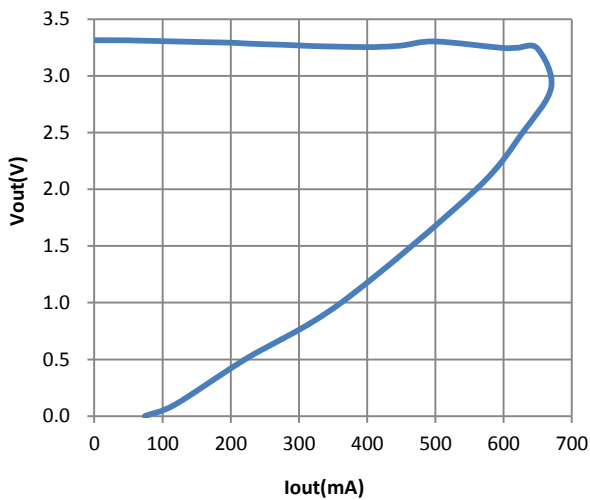

## Line transient response

Vin=5V~6V, Iout=10mA  
Ch1—Vin, Ch2—Vout

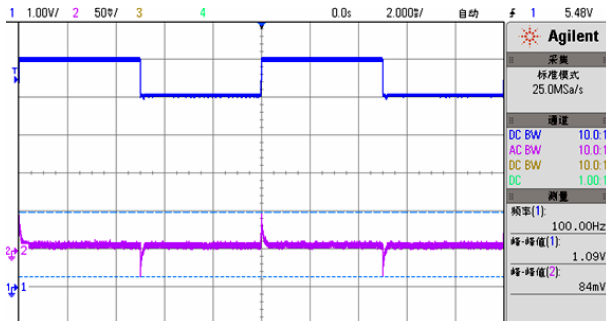

## Load transient response

Vin=5V, Iout=5mA~150mA  
Ch2—Vout, Ch4—Iout

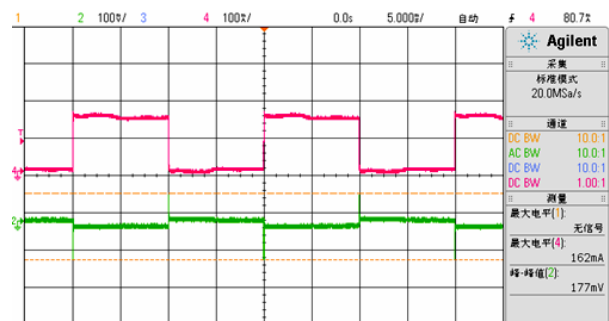

## PACKAGE LINE

Package	SOT-23-5	Devices per reel	3000Pcs	Unit	mm
Package dimension:					

# LC1215

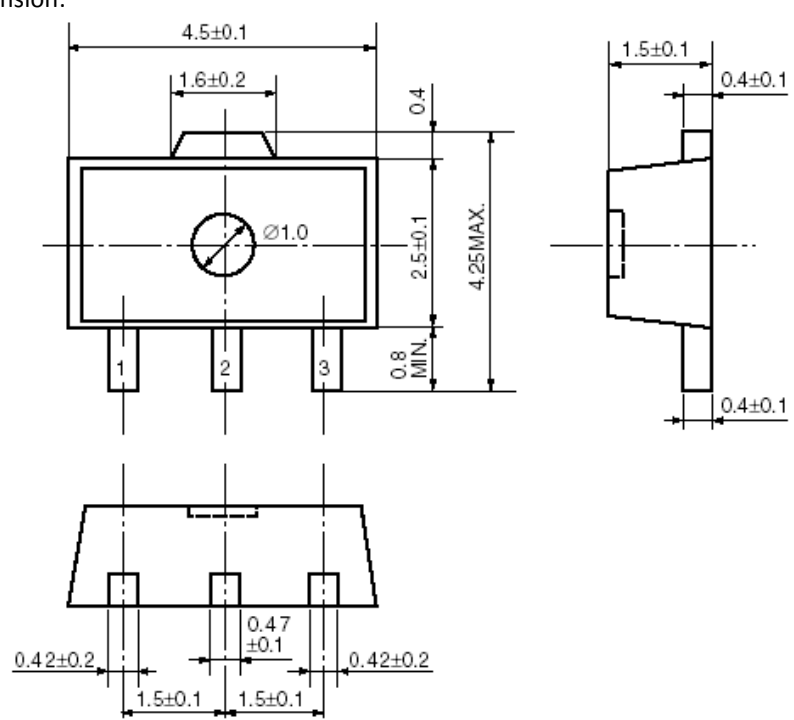
Package	SOT-89-3	Devices per reel	1000Pcs	Unit	mm
Package Dimension:					
 <p>The technical drawing illustrates the LC1215 SOT-89-3 package in three views: top, side, and bottom. The top view shows a rectangular package with a width of <math>4.5 \pm 0.1</math> mm and a central circular feature with a diameter of <math>\varnothing 1.0</math> mm. The distance from the center to the top edge is <math>1.6 \pm 0.2</math> mm. The package has three leads labeled 1, 2, and 3. The distance from the center to lead 1 is <math>0.42 \pm 0.2</math> mm, and the distance between leads 1 and 2 is <math>1.5 \pm 0.1</math> mm. The distance between leads 2 and 3 is <math>1.5 \pm 0.1</math> mm. The distance from the center to lead 3 is <math>0.42 \pm 0.2</math> mm. The height of the package is <math>2.5 \pm 0.1</math> mm, with a maximum height of <math>4.25</math> mm. The distance from the top edge to the top of the leads is <math>0.4</math> mm. The distance from the bottom edge to the bottom of the leads is <math>0.8</math> mm (MIN.). The side view shows a package with a width of <math>1.5 \pm 0.1</math> mm and a height of <math>0.4 \pm 0.1</math> mm. The bottom view shows a package with a width of <math>1.5 \pm 0.1</math> mm and a height of <math>0.47 \pm 0.1</math> mm. The distance from the center to the bottom edge is <math>0.42 \pm 0.2</math> mm.</p>					

**Siitek** 代理商：深圳市琪远电子有限公司  
电话：(0755)86228541 / 17727576605  
更多产品请访问：www.siitek.com.cn