



LC1472

300mA High PSRR, Linear Regulator

DESCRIPTION

LC1472 series is a group of positive voltage output, low power consumption, low dropout voltage regulator.

LC1472 can provide output value in the range of 1.0V~4.5V every 0.1V step. It also can be customized on command.

LC1472 includes high accuracy voltage reference, error amplifier, current limit circuit and output driver module.

LC1472 has excellent load and line transient response and good temperature characteristics, which can assure the stability of chip and power system. And it uses trimming technique to guarantee output voltage accuracy within $\pm 2\%$.

LC1472 is available in SOT-23-3, SOT-23-5, SC-70-5 and DFN1x1-4 packages which is lead free.

FEATURES

- Low Power Consumption: 35 μ A (Typ.)
- Low output noise (47 μ V_{RMS})
- Standby Mode: 0.1 μ A
- Low dropout Voltage: 300mV@300mA (Typ.)
- High Ripple Rejection: 70dB@1KHz (Typ.)
- Low Temperature Coefficient: ± 100 ppm/ $^{\circ}$ C
- Excellent Line regulation: 0.05%/V
- Build-in chip enable circuit
- Output Voltage Range: 1.0V~4.5V (customized on command every 0.1V step)
- Highly Accurate: $\pm 2\%$
- Output Current Limit

APPLICATIONS

- Power source for cellular phones and various kind of PCSs
- Battery Powered equipment
- Power Management of MP3, PDA, DSC, Mouse, PS2 Games
- Reference Voltage Source
- Regulation after Switching Power

TYPICAL APPLICATION

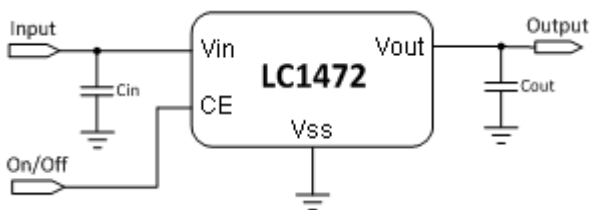

NOTE: Input capacitor ($C_{in}=1\mu F$) and Output capacitor ($C_{out}=1\mu F$) are recommended in all application circuit.

ELECTRICAL CHARACTERISTICS

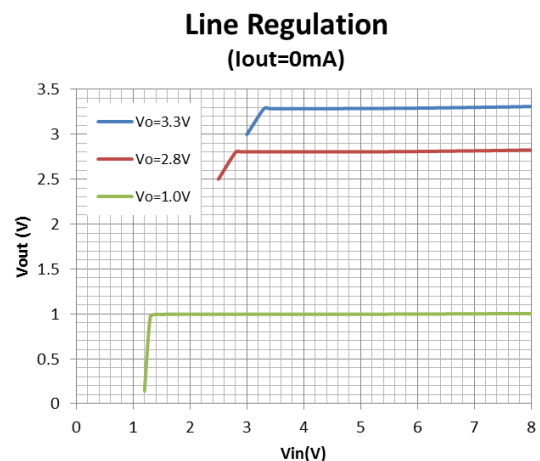

ORDERING INFORMATION

LC1472 [1](#) [2](#) [3](#) [4](#)

Code	Description
1	Temperature&Rohs: C:-40~85°C ,Pb Free Rohs Std.
2	Package type: A5:SC-70-5 B3:SOT-23-3 B5:SOT-23-5 KE:DFN1x1-4
3	Packing type: TR:Tape&Reel (Standard)
4	Output voltage: e.g. 15=1.5V 18=1.8V 44=4.4V

MARKING DESCRIPTON

JD: Product Code

X: Output Voltage Code (for SC70-5, SOT23-3, SOT23-5)

Vout	Code	Vout	Code	Vout	Code
1.0V	0	2.3V	$\bar{3}$	3.6V	$\bar{6}$
1.1V	1	2.4V	$\bar{4}$	3.7V	$\bar{7}$
1.2V	2	2.5V	$\bar{5}$	3.8V	$\bar{8}$
1.3V	3	2.6V	$\bar{6}$	3.9V	$\bar{9}$
1.4V	4	2.7V	$\bar{7}$	4.0V	$\bar{0}$
1.5V	5	2.8V	$\bar{8}$	4.1V	$\bar{1}$
1.6V	6	2.9V	$\bar{9}$	4.2V	$\bar{2}$
1.7V	7	3.0V	$\bar{0}$	4.3V	$\bar{3}$
1.8V	8	3.1V	$\bar{1}$	4.4V	$\bar{4}$
1.9V	9	3.2V	$\bar{2}$	4.5V	$\bar{5}$
2.0V	$\bar{0}$	3.3V	$\bar{3}$		
2.1V	$\bar{1}$	3.4V	$\bar{4}$		
2.2V	$\bar{2}$	3.5V	$\bar{5}$		

XX: Output Voltage (for DFN1X1-4). "18" stands for 1.8V, "28" stands for 2.8V, and "2 $\bar{8}$ " stands for 2.85V.

Y: The Year of manufacturing, "7" stands for year 2007, "8" stands for year 2008, and " $\bar{0}$ " stands for year 2010.

W: The week of manufacturing. "A" stands for week 1, "Z" stands for week 26, " \bar{A} " stands for week 27, " \bar{Z} " stands for week 52.

PIN CONFIGURATION

Product Classification	LC1472CA5TR□□
JD: Product Code	
X: Output Voltage	
YW: Date Code	
Product Classification	LC1472CB3TR□□
JD: Product Code	
X: Output Voltage	
YW: Date Code	
Product Classification	LC1472CB5TR□□
JD: Product Code	
X: Output Voltage	
YW: Date Code	
Product Classification	LC1472CKETR□□
XX: Output Voltage	
Vss	Ground Pin
Vin	Supply Voltage Input
Vout	Output Voltage
CE	Chip Enable
NC	No Connection

ABSOLUTE MAXIMUM RATING

Parameter		Value
Max Input Voltage		8V
Operating Junction Temperature(Tj)		125°C
Output Current		300mA
Ambient Temperature(Ta)		-40°C –85°C
Power Dissipation	SC70-5	250mW
	SOT-23-3	250mW
	SOT-23-5	250mW
	DFN1x1-4	600mW
Storage Temperature(Ts)		-40°C -150°C
Lead Temperature & Time		260°C,10S

Note:

Heat Sink Area of PCB for DFN1x1-4 is recommended at least 2.5mmx4mm.

Exceed these limits to damage to the device.

Exposure to absolute maximum rating conditions may affect device reliability.

RECOMMENDED WORK CONDITIONS

Item	Min	Recommended	Max.	Unit
Input Voltage Range	2		6	V
Ambient Temperature	-40		85	°C

ELECTRICAL CHARACTERISTICS

(Test Conditions: Cin=1uF,Cout=1uF,TA=25°C, unless otherwise specified.)

LC1472, For Arbitrary Output Voltage

Symbol	Parameter	Conditions	Min	Typ	Max	Units	
Vin	Input Voltage		2		6	V	
Vout	Output Voltage	Vout>1.5V	Vin=Set Vout+1V 1mA≤Iout≤30mA	Vout x0.98	Vout	Vout X1.02	V
		Vout≤1.5V		Vout -0.03		Vout +0.03	
Iout (Max.)	Maximum Output Current	Vin-Vout=1V	300			mA	
Vdrop ¹	Dropout Voltage,Vout≥2.8V	Iout=100mA		100	150	mV	
		Iout=300mA		300	400	mV	
$\frac{\Delta V_{out}}{\Delta V_{in} \cdot V_{out}}$	Line Regulation	Iout=40mA 2.8V≤Vin≤6V		0.05	0.2	%/V	
$\Delta V_{out} / \Delta I_{out}$	Load Regulation	Vin=Set Vout+1V 1mA≤Iout≤300mA		50	80	mV	
Iss	Supply Current	Vin=Set Vout+1V		35	80	uA	
Istandby	Supply Current (Srandby)	Vin=Set Vout+1V Vce=Vss		0.1	1.0	uA	
$\frac{\Delta V_{out}}{\Delta T \cdot V_{out}}$	Output Voltage Temperature Coefficiency	Iout=30mA		±100		ppm/°C	

LC1472

PSRR	Ripple Rejection	F=1KHz, Ripple=0.5Vp-p Vin=Set Vout+1V		70		dB
Ilim	Current Limit		300			mA
Vceh	CE Input Voltage "H"		1.5		Vin	V
Vcel	CE Input Voltage "L"		0		0.25	V
en	Output Noise	BW=10Hz~100kHz		47		uVrms

NOTE:

$V_{drop} = V_{in1} - (V_{out2} * 0.98)$ V_{out2} is the output voltage when $V_{in} = V_{out1} + 1.0V$ and $I_{out} = 300mA$.

V_{in1} is the input voltage at which the output voltage becomes 98% of V_{out1} after gradually decreasing the input voltage.

BLOCK DIAGRAM

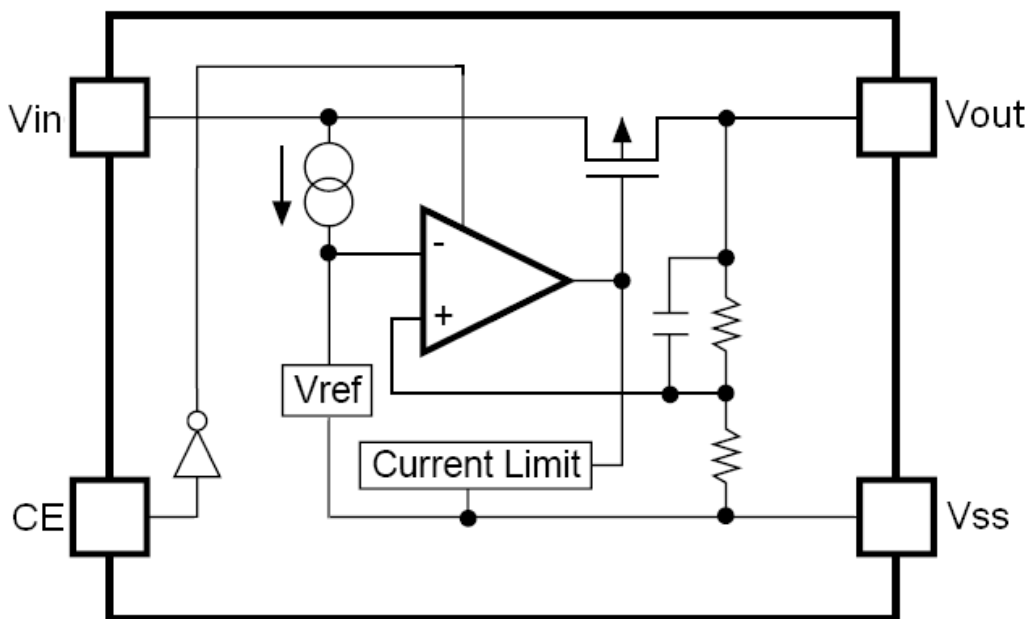

EXPLANATION

LC1472 series is a group of positive voltage output, low noise, low power consumption, low dropout voltage regulator.

LC1472 can provide output value in the range of 1.0V~4.5V every 0.1V step. It also can be customized on command.

LC1472 includes high accuracy voltage reference, error amplifier, current limit circuit and output driver module.

LC1472 has excellent load and line transient response and good temperature characteristics, which can assure the stability of chip and power system. And it uses trimming technique to guarantee output voltage accuracy within $\pm 2\%$.

TYPICAL PERFORMANCE CHARACTERISTICS

Load Regulation
($V_{out}=3.3V$)

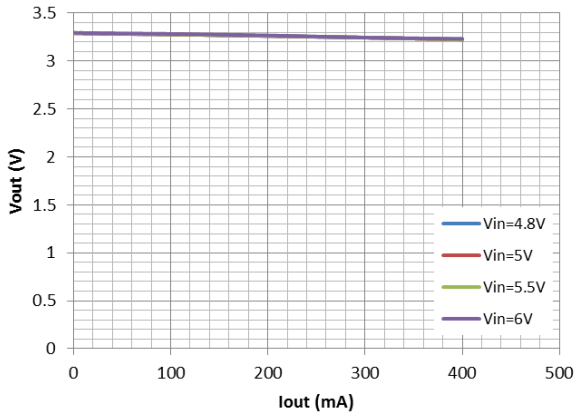

Load Regulation
($V_{out}=2.8V$)

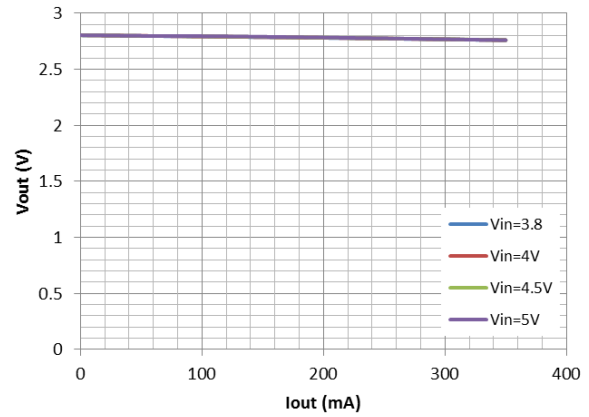

Load Regulation
($V_{out}=1.0V$)

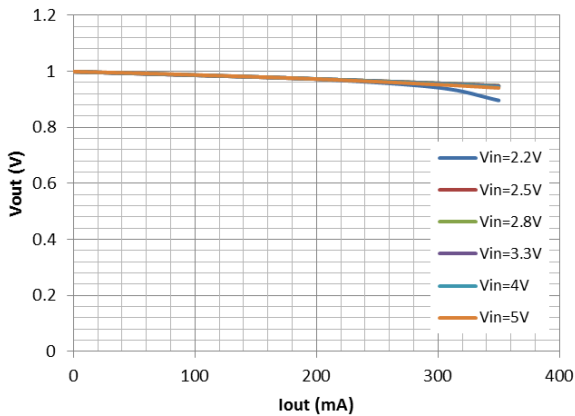

Line Regulation
($I_{out}=0mA$)

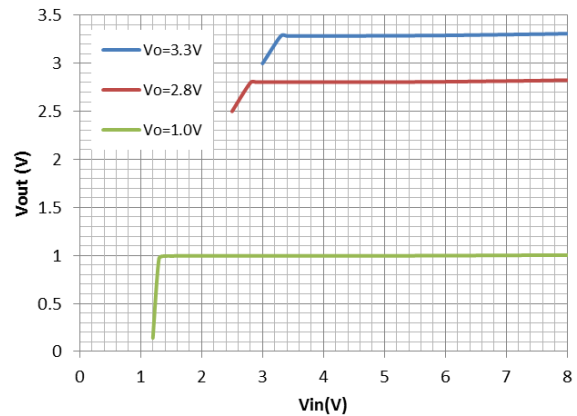

Quiescent Current
($I_{out}=0mA$ and $C_E=high$)

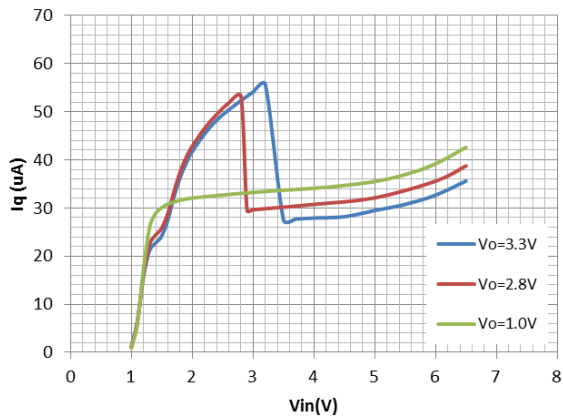

Dropout Voltage
($V_{out}=3.3V$)

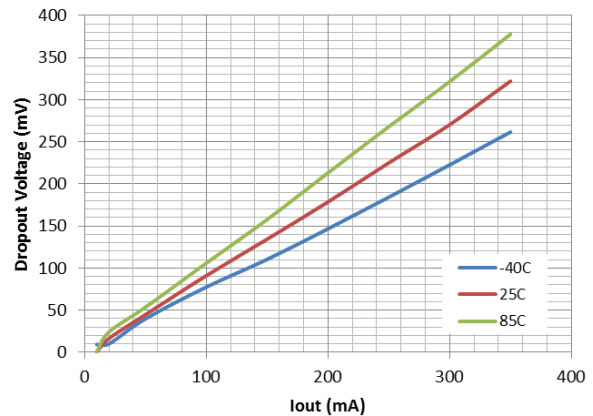

Dropout Voltage

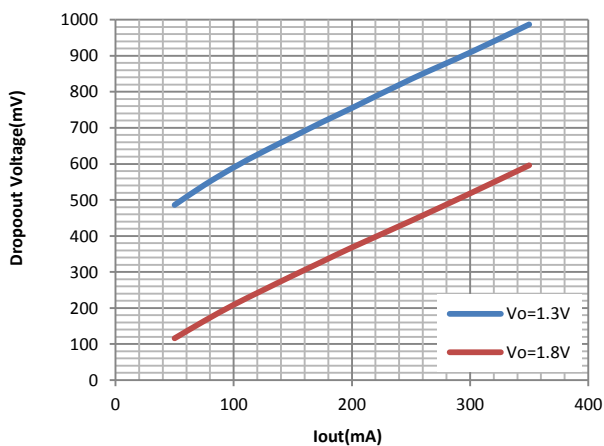

Vout Temperature Coefficient (Vout=3.3V)

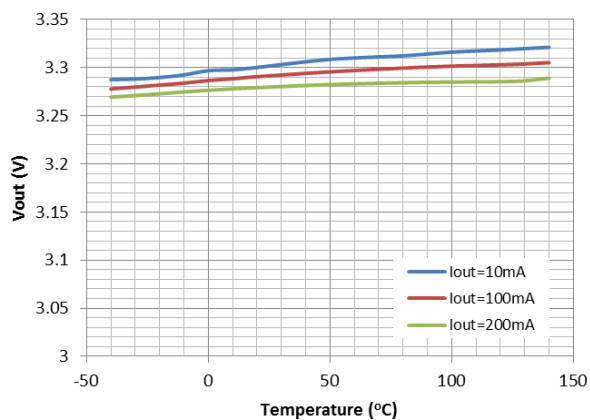

Line Transient Response

Vout=3.3V, Iout=20mA
(brown: Vin; Red: Vout)

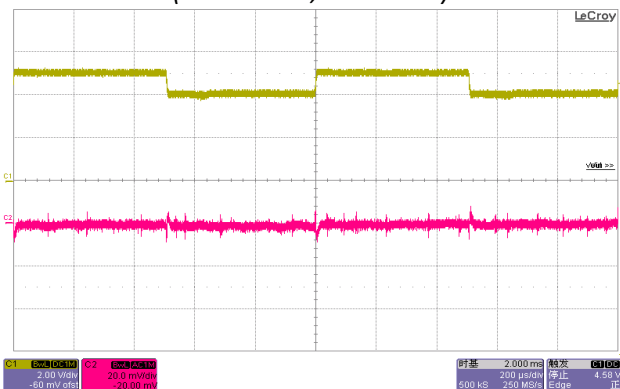

Load Transient Response

Vin=5V, Vout=3.3V, Iout=1-100mA
(Green: Iout; Red: Vout)

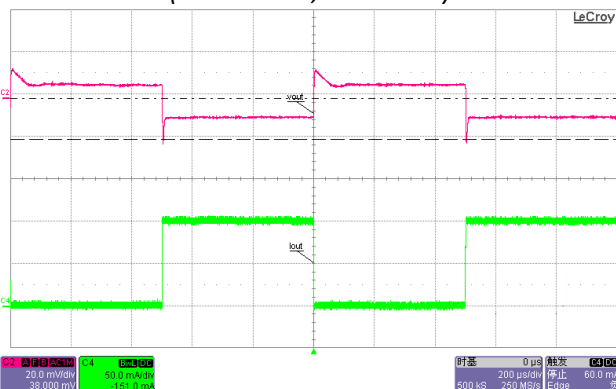

CE Chip Enable Response

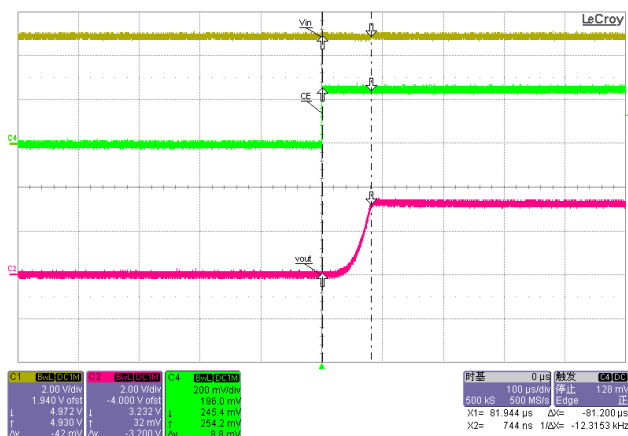

PACKAGE OUTLINE

Package	SC70-5	Devices per reel	3000Pcs	Unit	mm
Package dimension:					
Package	SOT-23-5	Devices per reel	3000Pcs	Unit	mm
Package Dimension:					

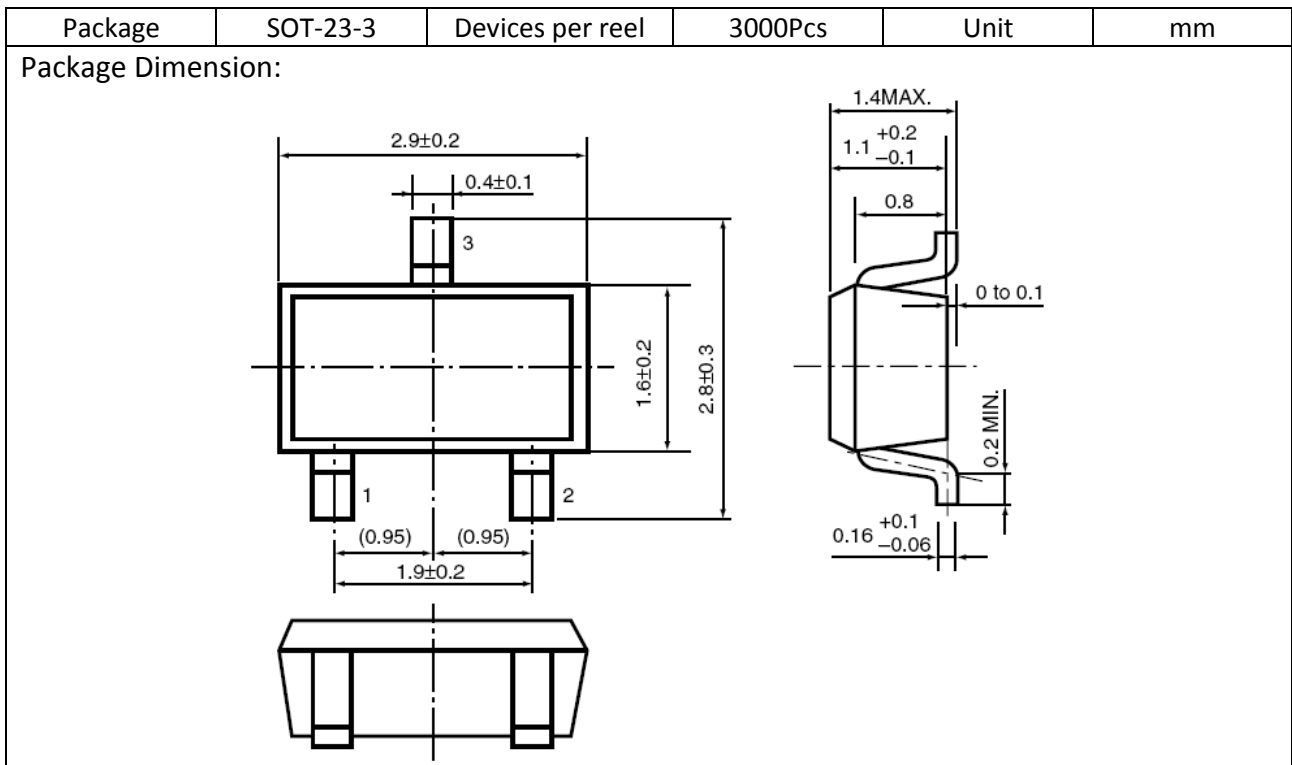

Package	DFN1x1-4	Devices per reel	5000Pcs	Unit	mm
---------	----------	------------------	---------	------	----

