



# LC1479

## 300mA High PSRR, Fast Response Linear Regulator

### DESCRIPTION

LC1479 series is a group of positive voltage output, low power consumption, low dropout voltage regulator.

LC1479 can provide output value in the range of 1.0V~4.5V every 0.1V step. It also can be customized on command.

LC1479 includes high accuracy voltage reference, error amplifier, current limit circuit and output driver module with discharge capability.

LC1479 has excellent load and line transient response and good temperature characteristics, which can assure the stability of chip and power system. And it uses trimming technique to guarantee output voltage accuracy within  $\pm 2\%$ .

LC1479 is available in TSOT-23, SOT23-5 and DFN1x1-4 packages which are lead free.

### FEATURES

- Low Power Consumption: 50uA (Typ.)
- Low output noise (47uVRMS)
- Standby Mode: 0.1uA
- Low dropout Voltage:  
210mV@Iout=300mA, Vout=3V
- High Ripple Rejection: 68dB@1KHz (Typ.)
- Low Temperature Coefficient:  $\pm 100$ ppm/ $^{\circ}$ C
- Excellent Line regulation: 0.05%/V
- Build-in chip enable and discharge circuit
- Output Voltage Range: 1.0V~4.5V  
(customized on command every 0.1V step)
- Highly Accurate:  $\pm 2\%$
- Output Current Limit

### APPLICATIONS

- Power source for cellular phones and various kind of PCSs
- Battery Powered equipment
- Power Management of MP3, PDA, DSC, Mouse, PS2 Games
- Reference Voltage Source
- Regulation after Switching Power

### TYPICAL APPLICATION

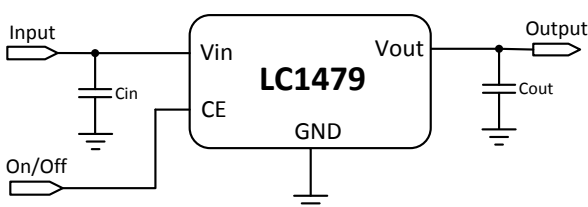

NOTE: Input capacitor ( $C_{in}=1\mu F$ ) and Output capacitor ( $C_{out}=1\mu F$ ) are recommended in all application circuit.

### ELECTRICAL CHARACTERISTICS

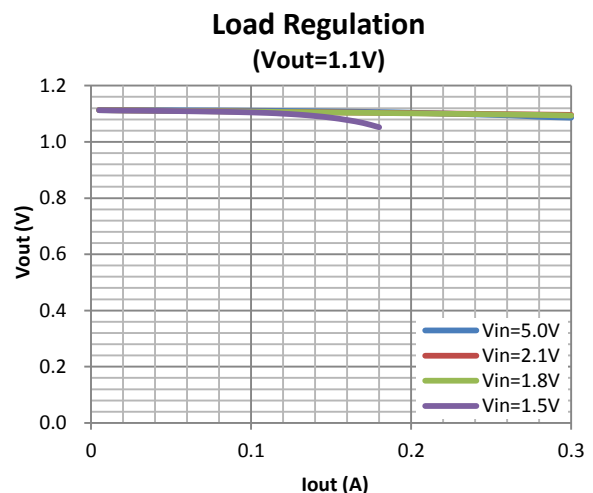

## ORDERING INFORMATION

LC1479 [1](#) [2](#) [3](#) [4](#)

Code	Description
<a href="#">1</a>	Temperature&RoHS: C:-40~85°C ,Pb Free RoHS Std. A: short circuit current >100mA
<a href="#">2</a>	Package type: B3A: TSOT-23 B5: SOT-23-5 B5B: SOT-23-5 (B) KE: DFN1x1-4
<a href="#">3</a>	Packing type: TR:Tape&Reel (Standard)
<a href="#">4</a>	Output voltage: e.g. 15=1.5V 18=1.8V 45=4.5V

## MARKING DESCRIPTON

U: Product Code  
X: Output Voltage

Vout	Code	Vout	Code	Vout	Code
1.0V	0	2.3V	<u>3</u>	3.6V	<u>6</u>
1.1V	1	2.4V	<u>4</u>	3.7V	<u>7</u>
1.2V	2	2.5V	<u>5</u>	3.8V	<u>8</u>
1.3V	3	2.6V	<u>6</u>	3.9V	<u>9</u>
1.4V	4	2.7V	<u>7</u>	4.0V	<u>0</u>
1.5V	5	2.8V	<u>8</u>	4.1V	<u>1</u>
1.6V	6	2.9V	<u>9</u>	4.2V	<u>2</u>
1.7V	7	3.0V	<u>0</u>	4.3V	<u>3</u>
1.8V	8	3.1V	<u>1</u>	4.4V	<u>4</u>
1.9V	9	3.2V	<u>2</u>	4.5V	<u>5</u>
2.0V	<u>0</u>	3.3V	<u>3</u>		
2.1V	<u>1</u>	3.4V	<u>4</u>		
2.2V	<u>2</u>	3.5V	<u>5</u>		

Y: The Year of manufacturing, "1" stands for year 2011, "2" stands for year 2012, and "8" stands for year 2018.

W: The week of manufacturing. "A" stands for week 1, "Z" stands for week 26, "A" stands for week 27, "Z" stands for week 52.

## PIN CONFIGURATION

Product Classification	LC1479CB3ATR□□
U: Product Code	
X: Output Voltage	
YW: Date Code	
Product Classification	LC1479CB5TR□□
U: Product Code	
X: Output Voltage	
YW: Date Code	
Product Classification	LC1479CB5BTR□□
U: Product Code	
X: Output Voltage	
YW: Date Code	
Product Classification	LC1479CKETR□□
XX: Output Voltage	
GND	Ground Pin
Vin	Supply Voltage Input
Vout	Output Voltage
CE	Chip Enable
NC	No Connection

## ABSOLUTE MAXIMUM RATING

Parameter		Value
Max Input Voltage		8V
Operating Junction Temperature(Tj)		150°C
Output Current		300mA
Ambient Temperature(Ta)		-40°C –85°C
Package Thermal Resistance ( $\theta_{JA}$ )	SOT-23-5	220°C / W
	SOT-23-5 (B)	220°C / W
Power Dissipation	TSOT-23	250mW
	SOT-23-5	250mW
	SOT-23-5 (B)	250mW
	DFN1x1-4	600mW
Storage Temperature(Ts)		-40°C -150°C
Lead Temperature & Time		260°C,10S

**Note:**

- 1) Heat Sink Area of PCB for DFN1x1-4 is recommended at least 2.5mmx4mm.
- 2) Package Thermal Resistance value can be affected by PCB design, outside radiator, ambient airflow, operating power, it just shows for reference.
- 3) Exceed these limits to damage to the device.
- 4) Exposure to absolute maximum rating conditions may affect device reliability.

## RECOMMENDED WORK CONDITIONS

Item	Min	Recommended	Max.	Unit
Input Voltage Range	1.5		6	V
Ambient Temperature	-40		85	°C

## ELECTRICAL CHARACTERISTICS

(Test Conditions: Cin=1uF,Cout=1uF,TA=25°C, unless otherwise specified. )

LC1479, For Arbitrary Output Voltage

Symbol	Parameter		Conditions	Min	Typ	Max	Units
Vin	Input Voltage			1.5*		6	V
Vout	Output Voltage	V <sub>OUT</sub> >1.5V	Vin=Set Vout+1V 1mA≤I <sub>OUT</sub> ≤30mA	Vout x0.98	Vout	Vout X1.02	V
		V <sub>OUT</sub> ≤1.5V		Vout -0.03		Vout +0.03	
I <sub>OUT</sub> (Max.)	Maximun Output Current		Vin-Vout=1V	300			mA
V <sub>drop</sub> **	Dropout Voltage,Vout=3V		I <sub>OUT</sub> =200mA		135	250	mV
			I <sub>OUT</sub> =300mA		210	350	mV
$\frac{\Delta V_{out}}{\Delta V_{in} \cdot V_{out}}$	Line Regulation		I <sub>OUT</sub> =10mA 1.8V≤Vin≤6V		0.05	0.2	%/V
$\frac{\Delta V_{out}}{\Delta I_{out}}$	Load Regulation		Vin=Set Vout+1V 1mA≤I <sub>OUT</sub> ≤300mA		50	80	mV
I <sub>SS</sub>	Supply Current		Vin=Set Vout+1V		50	120	uA
I <sub>standby</sub>	Supply Current (Srandby)		Vin=Set Vout+1V Vce=GND		0.1	1.0	uA

# LC1479

$\frac{\Delta V_{out}}{\Delta T \cdot V_{out}}$	Output Voltage Temperature Coefficiency	$I_{out}=30mA$		$\pm 100$		ppm/°C
PSRR	Ripple Rejection	F=1KHz, Ripple=0.5Vp-p Vin=Set Vout+1V		68		dB
Ilim	Current Limit	Vin=5V, Vout=3V		1		A
Rdischarge	Discharge Resistor	CE=0, Vout=3.0V		150		ohm
Vceh	CE Input Voltage "H"		0.95		Vin	V
Vcel	CE Input Voltage "L"		0		0.25	V
en	Output Noise	BW=10Hz~100kHz		47		uVrms

**Note:**

\*  $I_{out}=100mA$  @  $V_{out}=1.0V - 1.2V$

\*\*  $V_{drop}=V_{in1}-(V_{out2} \cdot 0.98)$   $V_{out2}$  is the output voltage when  $V_{in}=V_{out1}+1.0V$  and  $I_{out}=300mA$ .  $V_{in1}$  is the input voltage at which the output voltage becomes 98% of  $V_{out1}$  after gradually decreasing the input voltage.

## BLOCK DIAGRAM

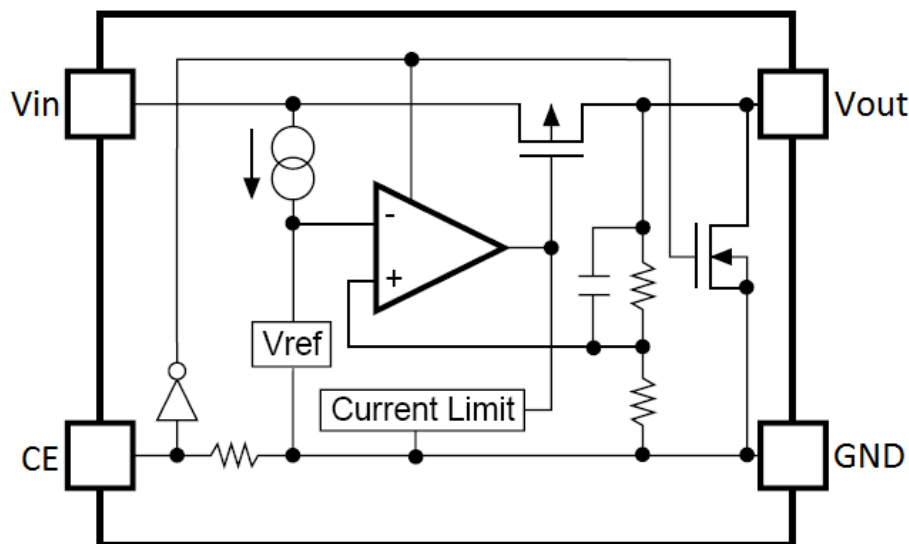

## EXPLANATION

LC1479 series is a group of positive voltage output, low noise, low power consumption, low dropout voltage regulator.

LC1479 can provide output value in the range of 1.0V~4.5V every 0.1V step. It also can be customized on command.

LC1479 includes high accuracy voltage reference, error amplifier, current limit circuit and output driver module.

LC1479 has excellent load and line transient response and good temperature characteristics, which can assure the stability of chip and power system. And it uses trimming technique to guarantee output voltage accuracy within  $\pm 2\%$ .

## TYPICAL PERFORMANCE CHARACTERISTICS

**Load Regulation  
(Vout=1.1V)**

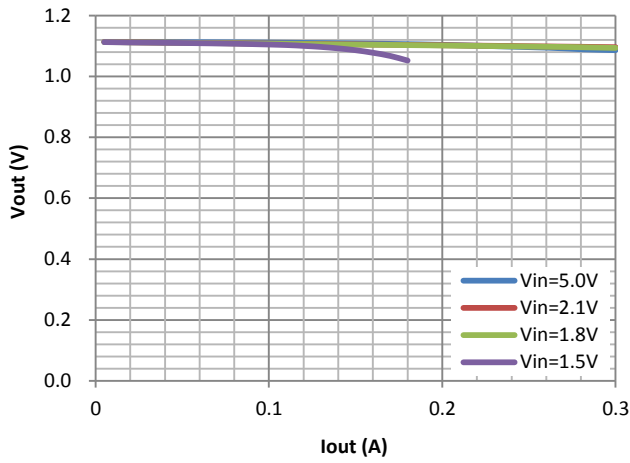

**Load Regulation  
(Vout=1.2V)**

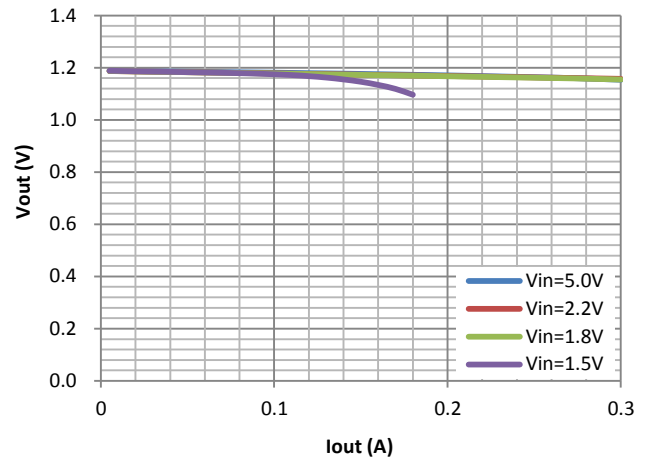

**Load Regulation  
(Vout=1.5V)**

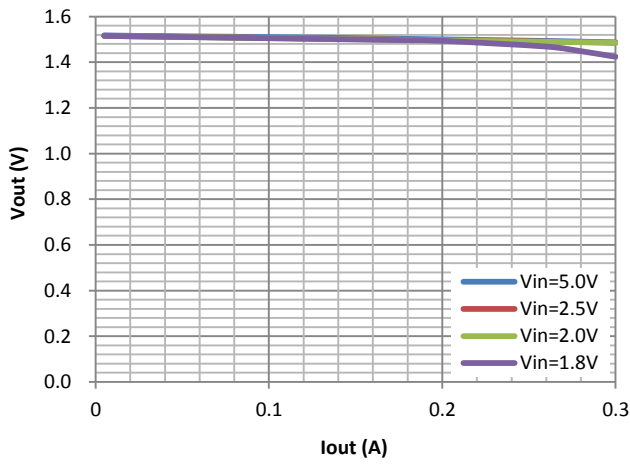

**Load Regulation  
(Vout=3V)**

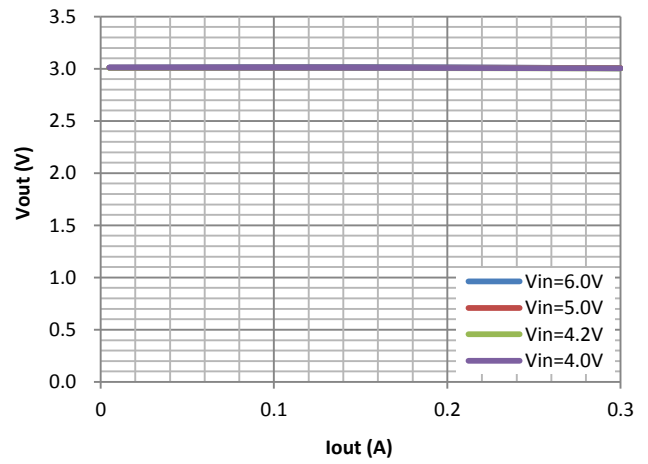

**Line Regulation**

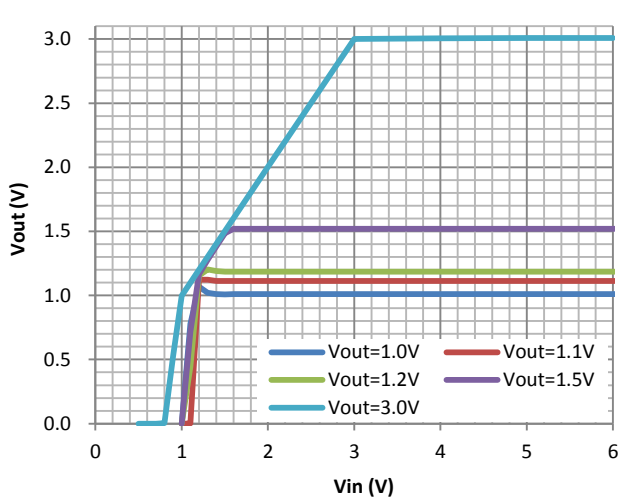

**Load Regulation  
(Vout=1.1V)**

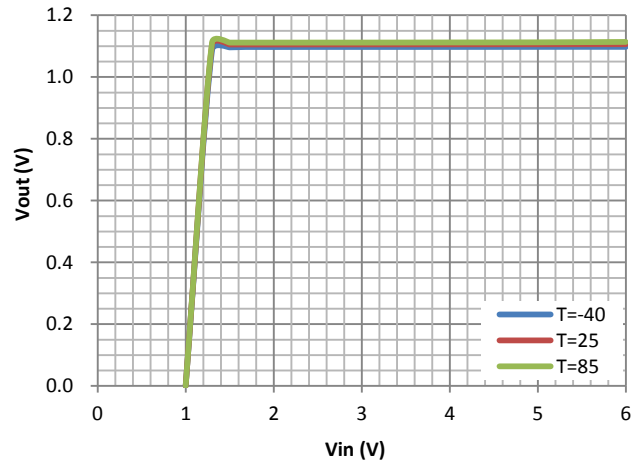

**Iq**  
(Vout=1V)

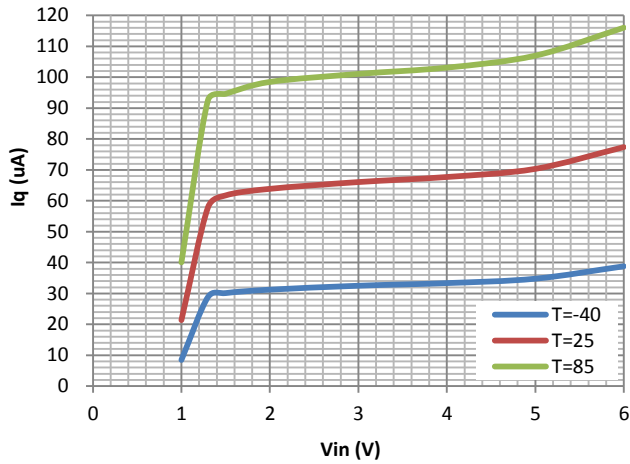

**Dropout Voltage**  
(Vout=3V)

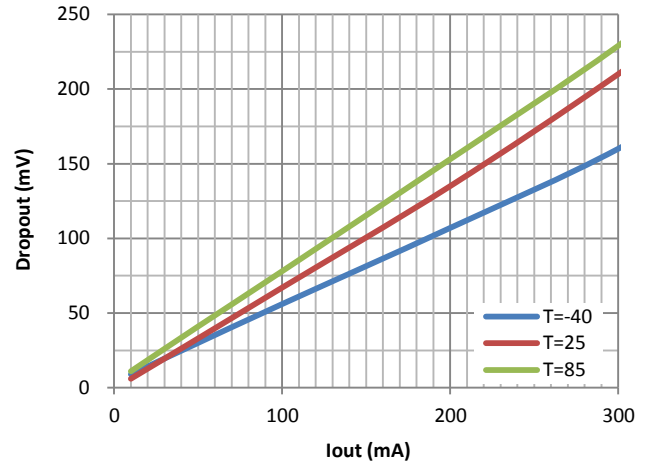

**CE Chip Enable Response**  
(Orange: Vin; Blue: CE; Green: Vout)

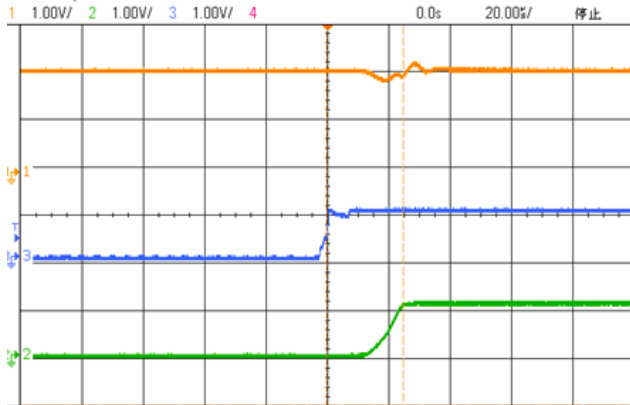

**Vout vs. Temperature**

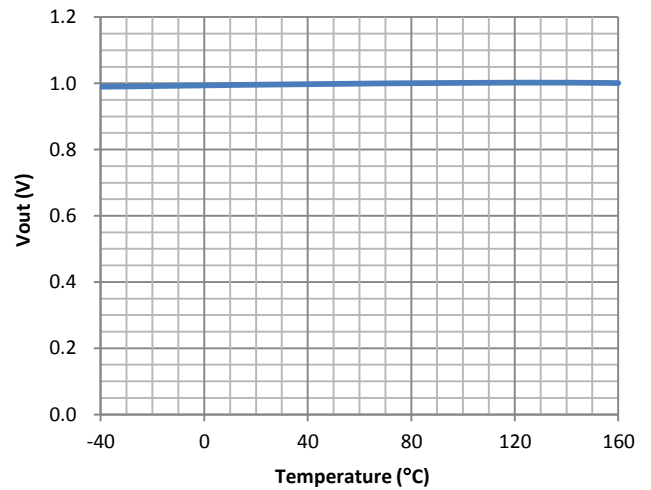

**Line Transient Response**

Vout=1.1V, Iout=10mA  
(Orange: Vin; Green: Vout)

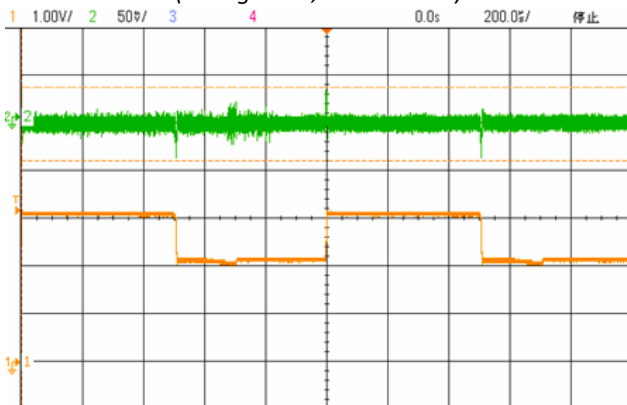

**Load Transient Response**

Vin=2V, Vout=1V, Iout=10-300mA  
(Pink: Iout; Green: Vout)

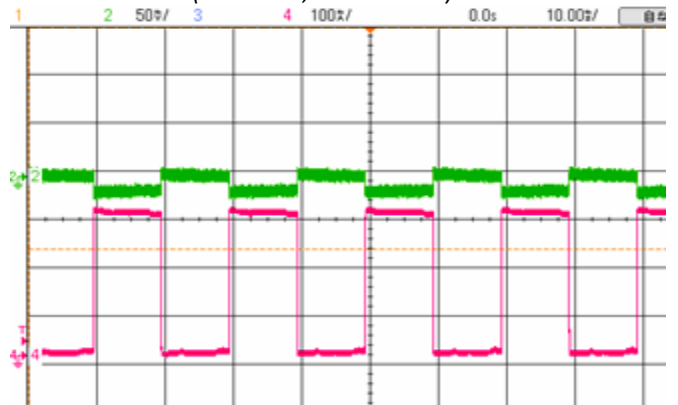

## PACKAGE OUTLINE

Package	TSOT-23	Devices per reel	3000Pcs	Unit	mm
Package dimension:					
<p>Technical drawing of the TSOT-23 package. It includes three views: a top view, a side view, and a cross-sectional view. The top view shows a rectangular package with a width of <math>2.400 \pm 0.05</math> mm and a length of <math>1.900 \pm 0.05</math> mm. The distance between the two leads is <math>0.400 \pm 0.03</math> mm. The lead length is <math>0.550 \pm 0.05</math> mm. The lead thickness is <math>0.100 \pm 0.01</math> mm. The lead width is <math>0.080 \pm 0.02</math> mm. The lead height is <math>0.400 \pm 0.05</math> mm. The lead tip radius is <math>4 \times R0.1</math> MAX. The side view shows a height of <math>1.300 \pm 0.05</math> mm and a length of <math>2.900 \pm 0.05</math> mm. The lead height is <math>0.400 \pm 0.05</math> mm. The lead tip radius is <math>4 \times R0.1</math> MAX. The cross-sectional view shows a lead height of <math>0.2</math> MIN, a lead width of <math>0.100 \pm 0.01</math> mm, and a lead thickness of <math>0.080 \pm 0.02</math> mm. The lead tip radius is <math>4 \times R0.1</math> MAX. The lead height is <math>0.400 \pm 0.05</math> mm. The lead tip radius is <math>4 \times R0.1</math> MAX. The lead height is <math>0.400 \pm 0.05</math> mm. The lead tip radius is <math>4 \times R0.1</math> MAX.</p>					

Package	SOT-23-5	Devices per reel	3000Pcs	Unit	mm
Package Dimension:					
<p>Technical drawing of the SOT-23-5 package. It includes three views: a top view, a side view, and a perspective view. The top view shows a rectangular package with a width of <math>2.9 \pm 0.2</math> mm and a length of <math>1.9 \pm 0.2</math> mm. The distance between the two leads is <math>0.95</math> mm. The lead length is <math>0.95</math> mm. The lead height is <math>0.4 \pm 0.1</math> mm. The lead tip radius is <math>4 \times R0.1</math> MAX. The side view shows a height of <math>1.6 \pm 0.1</math> mm and a length of <math>2.8 \pm 0.3</math> mm. The lead height is <math>0.4 \pm 0.1</math> mm. The lead tip radius is <math>4 \times R0.1</math> MAX. The cross-sectional view shows a lead height of <math>0.2</math> MIN, a lead width of <math>0.15 \pm 0.05</math> mm, and a lead thickness of <math>0.080 \pm 0.02</math> mm. The lead tip radius is <math>4 \times R0.1</math> MAX. The lead height is <math>0.400 \pm 0.05</math> mm. The lead tip radius is <math>4 \times R0.1</math> MAX. The lead height is <math>0.400 \pm 0.05</math> mm. The lead tip radius is <math>4 \times R0.1</math> MAX.</p>					

Package	DFN1x1-4	Devices per reel	5000Pcs	Unit	mm
---------	----------	------------------	---------	------	----

Package dimension:

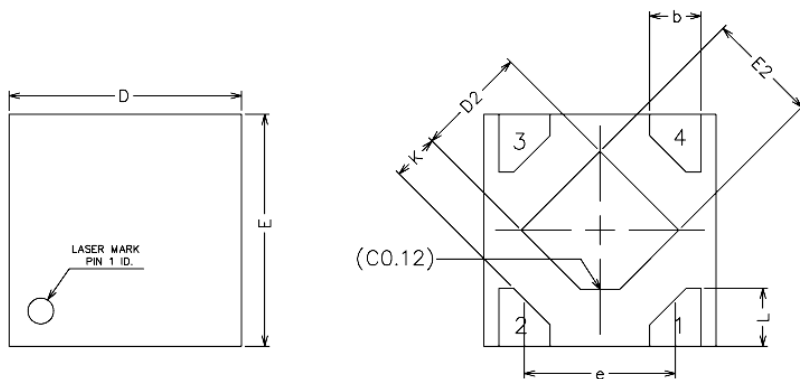

COMMON DIMENSIONS  
(UNITS OF MEASURE=MILLIMETER)

SYMBOL	MIN	NOM	MAX
A	0.50	0.55	0.60
A1	0.00	0.02	0.05
A3	0.100REF		
b	0.17	0.22	0.27
D	0.95	1.00	1.05
E	0.95	1.00	1.05
D2	0.43	0.48	0.53
E2	0.43	0.48	0.53
L	0.20	0.25	0.30
e	0.60	0.65	0.70
K	0.15	-	-

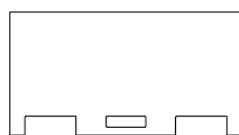
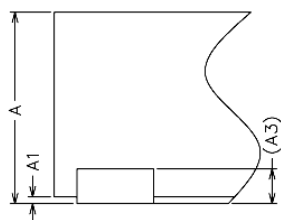

Notes: All dimensions are in millimeters exclude mold flash or protrusions.