



# LC2730

## 34V, 3.5A CC&CV Buck Converter

### DESCRIPTION

LC2730 has an optimum input voltage, step-down converter that operates in either CV (Constant Output Voltage) mode or CC (Constant Output Current) mode. The maximum input voltage is up to 34V and the operation input voltage from 8.5V to 32V.

MOSFET, what build in 35mΩ High-Side and 25mΩ Low-Side, could deliver up to 3.5A of continuous output current and the output current accurate to within ±7%.

External compensation is not needed. It consists of inside line compensation function with 150mV at VIN (12V), and the constant current value can be set by an external resistance.

In conclusion, LC2730 is a full function and high performance, high reliability buck DC-DC converter.

### FEATURES

- Build in High-Side and Low-Side MOSFET
- Max Output Current: 3.5A
- Constant Output Voltage: 5V
- Excellent Constant Current Accurate: ±7%
- Constant Voltage Accurate: ±1.5%
- No External Compensation Needed
- Jitter Function
- Efficiency: Up to 95%
- Line Compensation: Typ.150mV@VIN=12V
- Short Circuit Protection
- Over Voltage Protection
- Thermal shutdown Protection
- Under Voltage Lock Output
- Available in SOP-8 package

### APPLICATIONS

- Car DVD
- Black Box
- Car Charger
- Industry Application

### TYPICAL APPLICATION

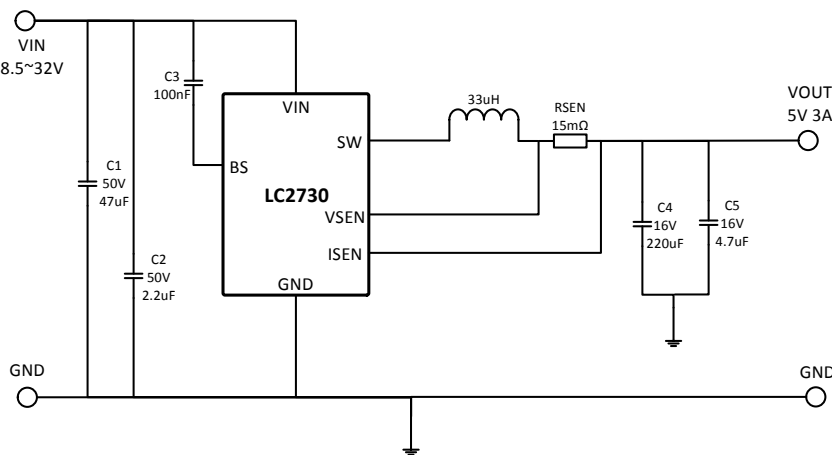

### PIN OUT & MARKING

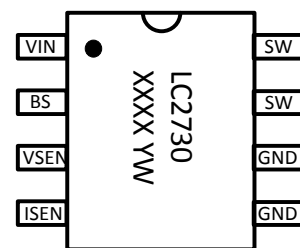

SOP-8

LC2730: Product Code  
 XXXX: Lot No.  
 YW: Date code (Year & Week)

## ORDERING INFORMATION

PART No.	PACKAGE	Tape&Reel
LC2730CD8TR	SOP-8	4000/Reel

## ABSOLUTE MAXIMUM RATING

Parameter	Value
VIN to GND	-0.3 to 34 V
SW to GND	-0.3 to 32 V
BS to GND	-0.3 to 34 V
ISEN, VSEN	-0.3 to 25 V
Max Operating Junction Temperature(Tj)	125°C
Ambient Temperature(Ta)	-40°C – 85°C
Package Thermal Resistance (θjc)	SOP-8 45°C / W
Storage Temperature(Ts)	-40°C – 150°C
Lead Temperature & Time	260°C, 10S
ESD (HBM)	>2000V

**Note:** Exceed these limits to damage to the device. Exposure to absolute maximum rating conditions may affect device reliability.

## ELECTRICAL CHARACTERISTICS

(Vin=12V, TA=25°C, unless otherwise stated)

Symbol	Parameter	Conditions	Min	Typ	Max	Unit
VIN	Input Voltage		8.5	-	34	V
V <sub>OVP-VIN</sub>	Input OVP Threshold		30	32	33	V
V <sub>UVLO</sub>	UVLO Voltage		7	8.5	9	V
	UVLO Hysteresis		0.3	0.8	1	V
I <sub>CCQ</sub>	Quiescent Current	V <sub>FB</sub> = 1.5V, force driver off.	-	1.5	-	mA
I <sub>SB</sub>	Standby Current	No Load	-	1.6	3	mA
V <sub>OUT</sub>	Output Voltage	I <sub>OUT</sub> =1A	4.93	5	5.08	V
V <sub>OVP</sub>	Output OVP detect Voltage	Internal define	-	6	-	V
F <sub>SW</sub>	Switching Frequency	I <sub>OUT</sub> =1A	115	140	165	KHz
Reference Of V <sub>ISEN</sub> -V <sub>VSEN</sub>	Reference Voltage Of Constant Current	0.4V<V <sub>FB</sub> <0.95V	46.5	50	53.5	mV
V <sub>SEN</sub>	V <sub>OUT-short</sub>		2	2.2	2.4	V
	Line Compensation	Vin=12V, I <sub>OUT</sub> =3.5A	-	150	-	mV
High side	RDS <sub>ON</sub> Of Power MOS	I <sub>OUT</sub> =1A	30	35	40	mΩ
Low side		I <sub>OUT</sub> =1A	22	25	30	mΩ
T <sub>SD</sub>	Thermal shutdown Temp		-	140	-	°C
T <sub>SH</sub>	Thermal Shutdown Hysteresis		-	30	-	°C

## PIN DESCRIPTION

PIN #	NAME	DESCRIPTION
1	VIN	Power Supply Input. Place a 2.2μF ceramic capacitor between VIN and GND as close as possible
2	BS	Power to the internal high-side MOSFET gate driver. Connect a 100nF capacitor from BS to VIN
3	VSEN	Current Sense Input_N
4	ISEN	Current Sense Input_P
5, 6	GND	Ground
7, 8	SW	Power Switching Output Connect to External Inductor

## TYPICAL PERFORMANCE CHARACTERISTICS

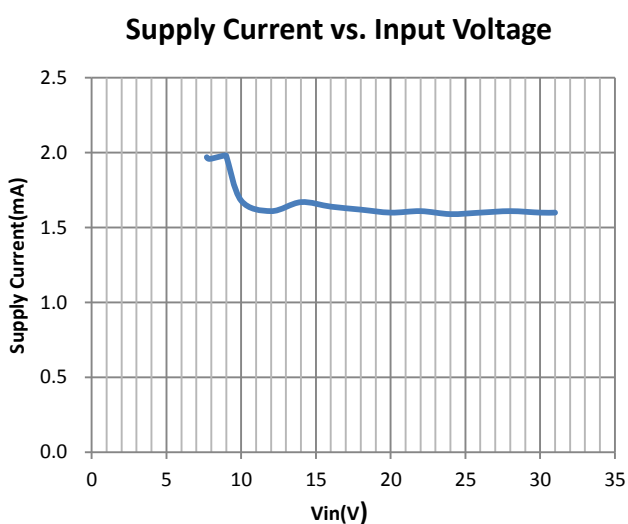
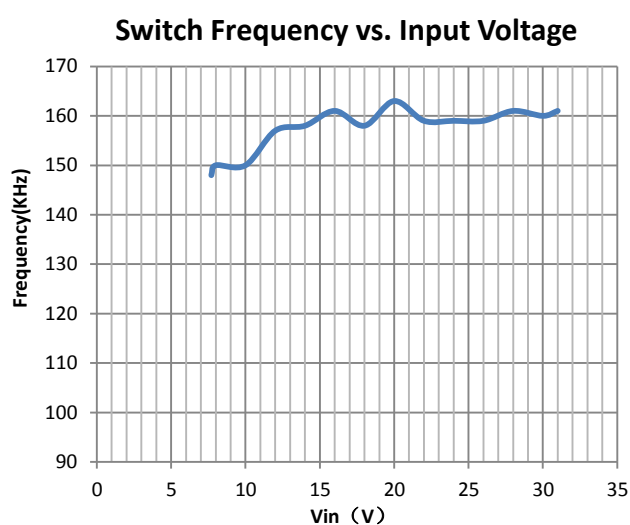
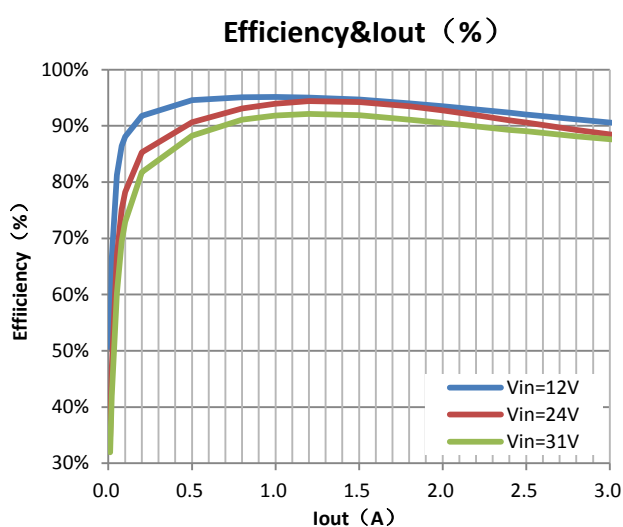

## Short Circuit

Vin=12V, Vout=5V, Freq=3.7Hz  
(CH3=SW)

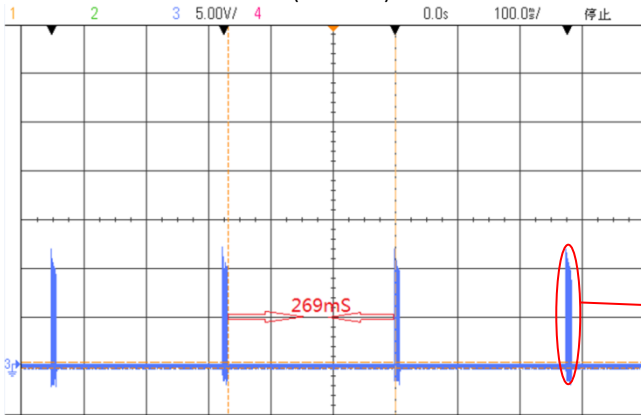

## Short Circuit

Vin=12V, Vout=5V, Freq=32kHz  
(CH3=SW)

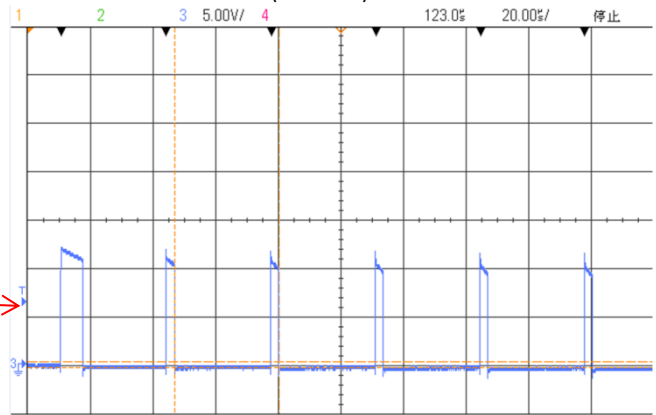

## Power On

Vin=12V, Vout=5V, Iout=3A  
(CH1=Vin, CH2=Vout, CH3=SW, CH4=Isw)

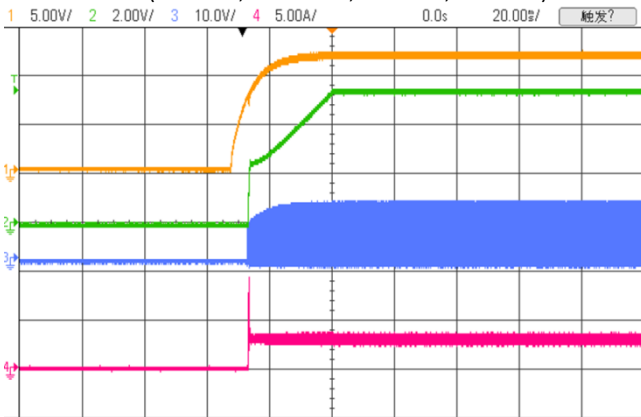

## Power Off

Vin=12V, Vout=5V, Iout=3A  
(CH1=Vin, CH2=Vout, CH3=SW, CH4=Isw)

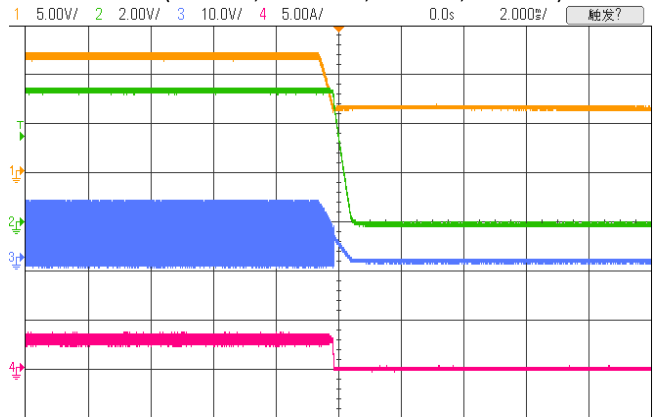

## Power On

Vin=24V, Vout=5V, Iout=3A  
(CH1=Vin, CH2=Vout, CH3=SW, CH4=Isw)

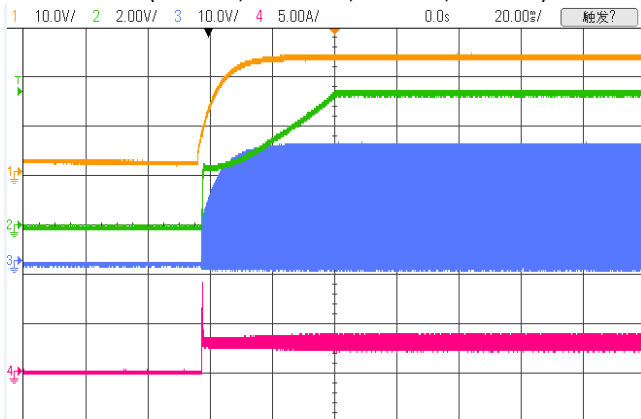

## Power Off

Vin=24V, Vout=5V, Iout=3A  
(CH1=Vin, CH2=Vout, CH3=SW, CH4=Isw)

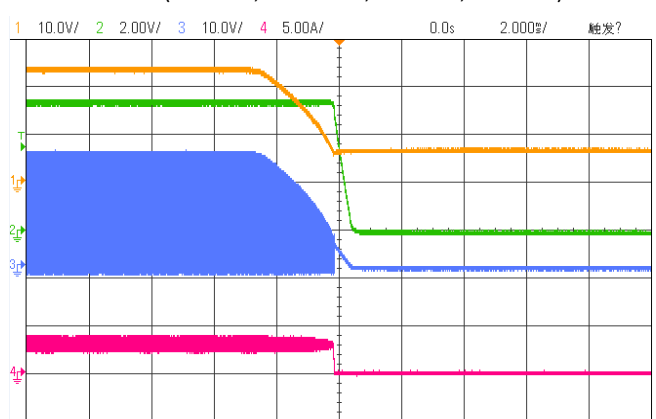

## Output Voltage Ripple

Vin=12V, Vout=5V, Iout=3A

(CH1=Vin, CH2=Vout, CH3=SW, CH4=Isw)

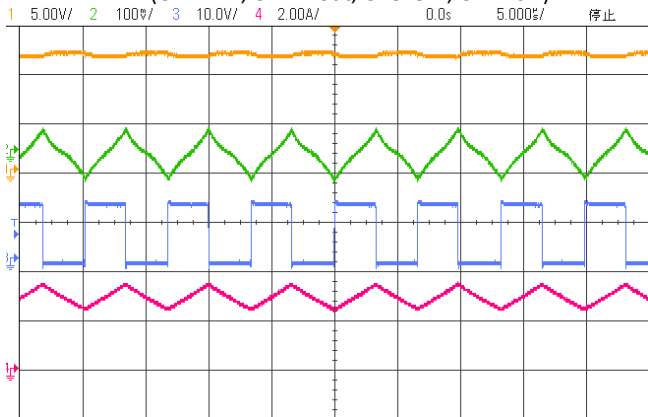

## Output Voltage Ripple

Vin=24V, Vout=5V, Iout=3A

(CH1=Vin, CH2=Vout, CH3=SW, CH4=Isw)

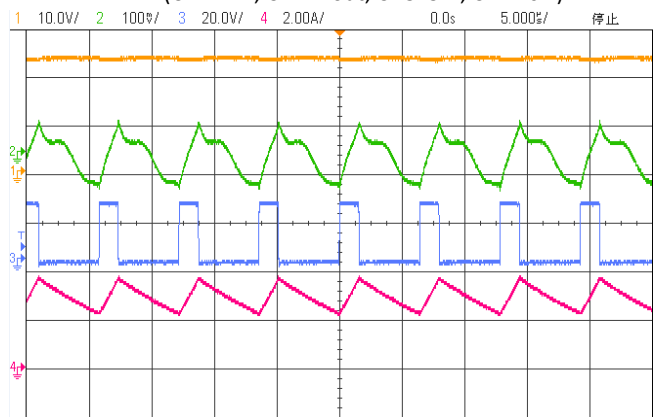

## DETAILED DESCRIPTION

### Input Under Voltage Protection

LC2730 provides an input voltage up to 34V and operates from an input voltage range of 8.5V to 32V. If VIN drops below 6.8V, the UVLO circuit inhibits switching. Once VIN rises above 8.5V, the UVLO clears, and the soft-start sequence activates.

### Input Over Voltage Protection

If VIN rises above 32V, the UVLO circuit inhibits switching. LC2730 will not be damaged until the voltage exceeds 34V. Once VIN drops below 30V, the UVLO clears, and the soft-start sequence activates.

### Soft-start

LC2730 has an internal soft-start circuitry to reduce supply inrush current during startup conditions. When the device exits under-voltage lockout (UVLO), shutdown mode, or restarts following a thermal-overload event, the soft-start circuitry slowly ramps up current available after 300µs.

### Constant Voltage Output

LC2730 presets the output voltage to 5V.

### Constant Current Output

LC2730 senses the current by sampling the voltage difference between ISEN and VSEN, and adjusts the output current to the default value by the loop.

$$I_{OUT} = \frac{50mV}{R_{ISEN}}$$

Constant current operates normally when VSEN is higher than 2.2V. When VSEN is below 2V causing

by overload, LC2730 will enter short circuit protection mode.

### Short Circuit Protection

When VSEN drops below 2V since too heavy load, LC2730 will enter short circuit protection function, and the system will enter hit-cup mode, and frequency drop to 40KHZ per cycle and stop switching for 270mS.

### Line Compensation

When output current from 0mA to full load, Output voltage will be increased 150mV (Max) for line compensation.

### Thermal Shutdown

Thermal-overload protection limits total power dissipation in the device. When the junction temperature exceeds TJ= +150°C, a thermal sensor forces the device into shutdown, allowing the die to cool. The thermal sensor turns the device on again after the junction temperature cools by 25°C, resulting in a pulsed output during continuous overload conditions. Following a thermal-shutdown condition, the soft-start sequence begins.

## Application Information

Layout is critical to achieve clean and stable operation. The switching power stage requires particular attention. Follow these guidelines for good PC board layout:

- 1) Place decoupling capacitors as close to the IC as possible

- 2) Connect input and output capacitors to the same power ground node with a star ground configuration then to IC ground.
- 3) Keep the high-current paths as short and wide as possible. Keep the path of switching current (C1 to VIN and C1 to GND) short. Avoid vias in the switching paths.
- 4) If possible, connect VIN, SW, and GND separately to a large copper area to help cool the IC to further improve efficiency and long-term reliability.
- 5) Ensure all feedback connections are short and direct. Place the feedback resistors as close to the IC as possible.
- 6) Route high-speed switching nodes away from sensitive analog areas

## PACKAGE OUTLINE

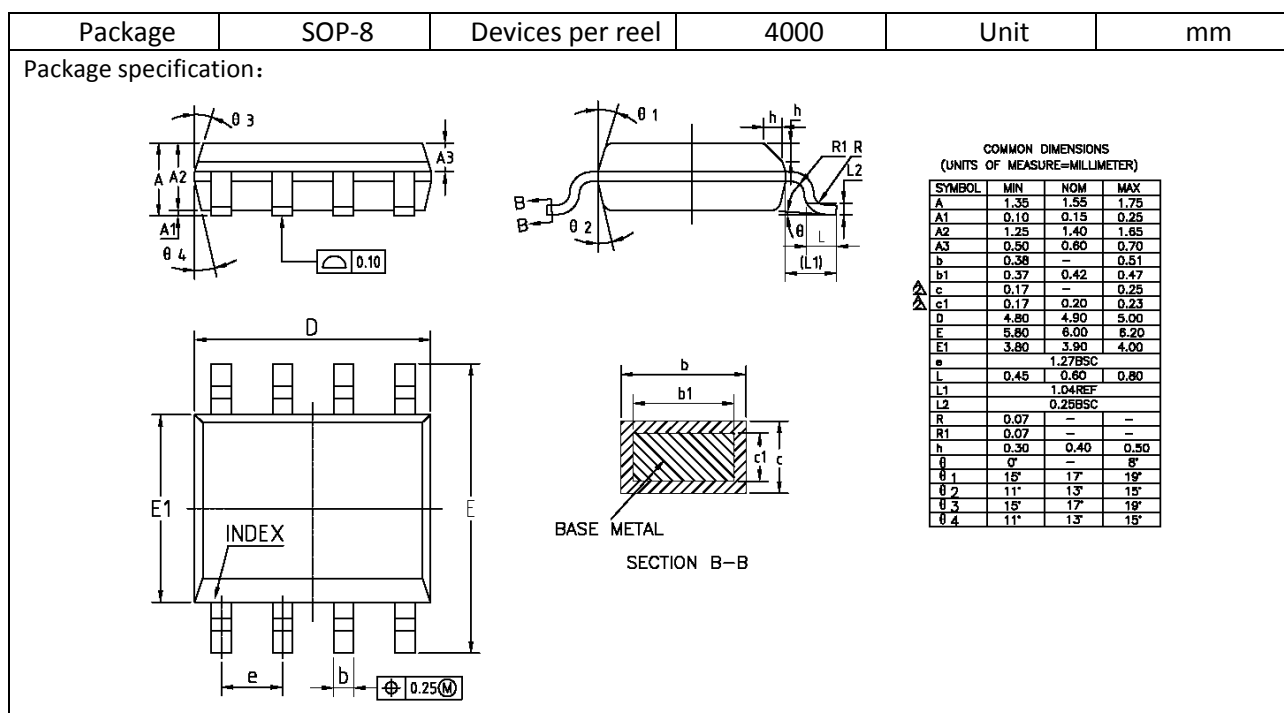

代理商：深圳市琪远电子有限公司  
 电话:(0755)86228541 / 17727576605  
 更多产品请访问：www.siitek.com.cn