

Ordering number: EN2361

CMOS LSI

SANYO **LC3517A, AM, AS, AL, AML, ASL**
2048-word × 8-bit CMOS Static RAM

OVERVIEW

LC3517A series devices are silicon-gate CMOS, static RAM ICs configured as 2048 words × 8 bits. They incorporate an output enable for high-speed memory access, and TTL-compatible, tristate outputs for direct interfacing with a bus.

LC3517A series ICs feature a data retention mode and a low standby current, making them ideal for low-power or battery-powered equipment. In particular, the LC3517AL, LC3517AML and LC3517ASL offer a guaranteed maximum standby current of 1 μA at 60 deg. C.

LC3517A series ICs operate from a 5 V supply and are available in 24-pin DIPs, 24-pin MFPs and 24-pin SDIPs.

FEATURES

- 100 ns (LC3517A-10 series), 120 ns (LC3517A-12 series) and 150 ns (LC3517A-15 series) maximum address access times
- 0.2 μA at 25 deg. C and 1.0 μA at 60 deg. C (LC3517AL/AML/ASL-10/12/15), and 5.0 μA at 60 deg. C and 30 μA at 85 deg. C (LC3517A/AM/ASL-10/12/15) maximum standby currents
- 55 mA maximum supply current at f = 1 MHz
- Data retention for V_{CC} = 2.0 to 5.5 V
- Asynchronous operation
- TTL-compatible, tristate input/outputs
- Single 5 V supply
- 24-pin DIP, 24-pin MFP and 24-pin SDIP

PINOUT

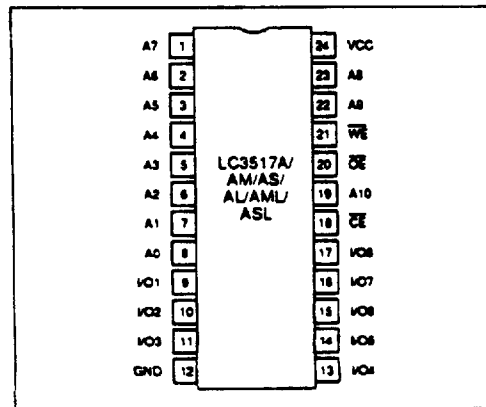

PACKAGE DIMENSIONS

Unit: mm

3072-DIP24NS (LC3517A/AL)

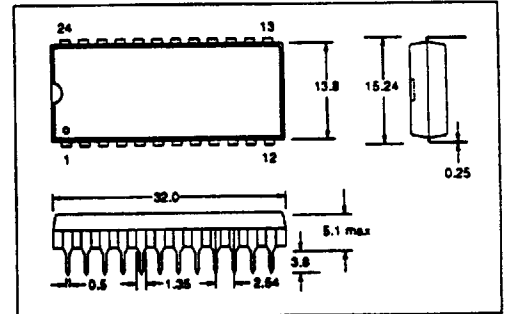

3045B-MFP24 (LC3517A/AML)

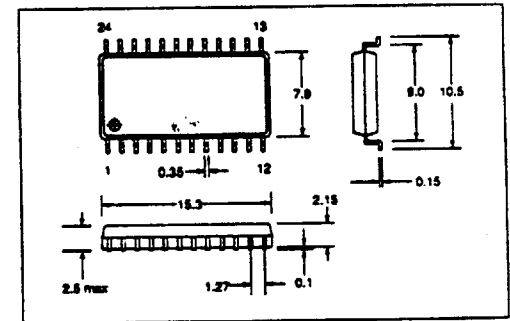

3092-DIP24SNS 300 mil (LC3517AS/ASL)

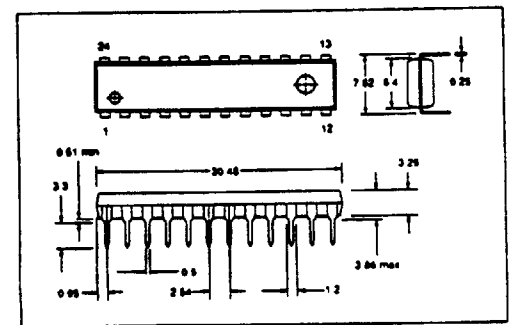

SANYO Electric Co., Ltd. Semiconductor Division
 Natsume Bldg., 18-6, 2-chome, Yushima, Bunkyo-ku, Tokyo 113, Japan

T-46-23-12

LC3517A, AM, AS, AL, AML, ASL

BLOCK DIAGRAM

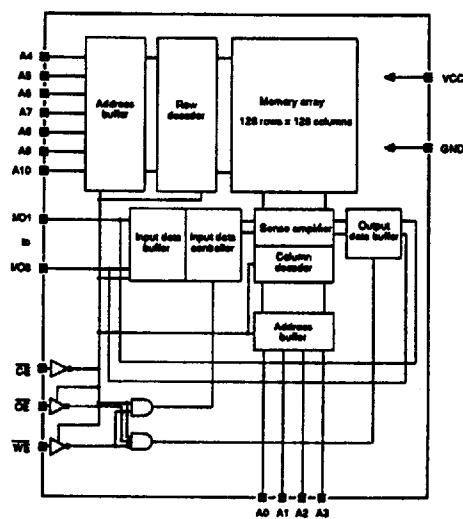

PIN DESCRIPTION

Number	Name	Description
1 to 8, 19, 22, 23	A0 to A10	Address inputs
9 to 11, 13 to 17	I/O1 to I/O6	Data inputs/outputs
12	GND	Ground
18	\overline{CE}	Chip enable input
20	\overline{OE}	Output enable input
21	\overline{WE}	Read/write select input
24	VCC	5 V supply

SPECIFICATIONS

Absolute Maximum Ratings

Parameter	Symbol	Rating	Unit
Supply voltage	$V_{CC \max}$	7.0	V
Input voltage range	V_{IH}	-0.5 to $V_{CC} + 0.5$	V
Input/output voltage range	V_{IO}	-0.5 to $V_{CC} + 0.5$	V
Operating temperature range	T_{op}	-30 to 85	deg. C
Storage temperature range	T_{stg}	-55 to 125	deg. C

T-46-23-12

LC3517A, AM, AS, AL, AML, ASL

Recommended Operating Conditions

 $T_a = 25 \text{ deg. C}$

Parameter	Symbol	Rating	Unit
Supply voltage	V_{CC}	5.0	V
Supply voltage range	$V_{CC \text{ op}}$	4.5 to 5.5	V

Electrical Characteristics

 $V_{CC} = 5 \text{ V} \pm 10\%$, $T_a = -30 \text{ to } 85 \text{ deg. C}$ unless otherwise noted

Parameter	Symbol	Condition	Rating			Unit	
			min	typ	max		
Quiescent supply current	I_{CCQ1}	$V_{CE} = 0 \text{ V}$, $V_{IN} = V_{CC}$ or GND, $I_{VO} = 0 \text{ mA}$	-	30	55	mA	
		$V_{CE} = V_{IL}$, $V_{IN} = V_{IH}$ or V_{IL} , $I_{VO} = 0 \text{ mA}$	-	40	70		
Average supply current	I_{CCA2}	Minimum cycle time, duty = 100%, $I_{VO} = 0 \text{ mA}$	-	50	80	mA	
Standby supply current	I_{CCS}	$V_{CE} = V_{CC} - 0.2 \text{ V}$, $V_{IN} = 0 \text{ V to } V_{CC}$. See note 1.	$T_a = 60 \text{ deg. C}$	-	-	5.0	μA
			$T_a = 85 \text{ deg. C}$	-	-	30	
		$V_{CE} = V_{CC} - 0.2 \text{ V}$, $V_{IN} = 0 \text{ V to } V_{CC}$. See note 2.	$T_a = 25 \text{ deg. C}$	-	-	0.2	
			$T_a = 60 \text{ deg. C}$	-	-	1.0	
		$V_{CE} = V_{IH}$, $V_{IN} = 0 \text{ V to } V_{CC}$	-	1.0	3.0	mA	
LOW-level input voltage	V_{IL}		-0.3	-	0.8	V	
HIGH-level input voltage	V_{IH}		2.2	-	$V_{CC} + 0.3$	V	
LOW-level output voltage	V_{OL}	$I_{OL} = 2.0 \text{ mA}$	-	-	0.4	V	
HIGH-level output voltage	V_{OH}	$I_{OH} = -1.0 \text{ mA}$	2.4	-	-	V	
Input capacitance	C_{IN}	$V_{IN} = 0 \text{ V}$, $f = 1 \text{ MHz}$, $T_a = 25 \text{ deg. C}$	-	-	5	pF	
Input/output capacitance	C_{VO}	$V_{VO} = 0 \text{ V}$, $f = 1 \text{ MHz}$, $T_a = 25 \text{ deg. C}$	-	-	10	pF	
Input leakage current	I_{LI}	$V_{IN} = 0 \text{ to } V_{CC}$	-1.0	-	1.0	μA	
Input/output leakage current	I_{LO}	V_{CE} or $V_{OE} = V_{IH}$, $V_{VO} = 0 \text{ V to } V_{CC}$	-5.0	-	5.0	μA	

Notes

- LC3517A/AM/AS-10/12/15
- LC3517AL/AML/ASL-10/12/15
- Typical values are measured at $V_{CC} = 5.0 \text{ V}$ and $T_a = 25 \text{ deg. C}$.

Timing Characteristics

Test conditions

- LOW-level pulse—0.6 V
- HIGH-level pulse—2.4 V
- Input rise and fall times—5 ns
- LOW-level timing reference— $V_{IL} = V_{OL} = 0.8 \text{ V}$
- HIGH-level timing reference— $V_{IH} = V_{OH} = 2.2 \text{ V}$
- Output load—1 TTL gate + $C_L = 100 \text{ pF}$ (including jig capacitance)

T-46-23-12

LC3517A, AM, AS, AL, AML, ASL

Read timing

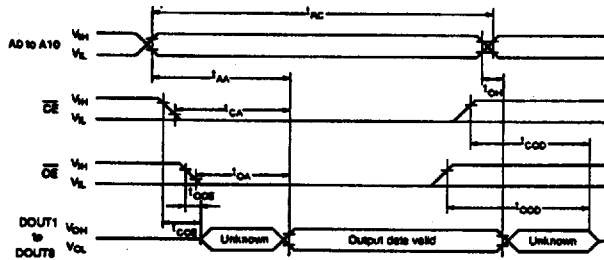

$V_{CC} = 5\text{ V} \pm 10\%$, $T_c = -30$ to 85 deg. C

Parameter	Symbol	LC3517A/AM/AS-10, LC3517AL/AML/ASL-10		LC3517A/AM/AS-12, LC3517AL/AML/ASL-12		LC3517A/AM/AS-15, LC3517AL/AML/ASL-15		Unit
		min	max	min	max	min	max	
Read cycle time	t_{AC}	100	-	120	-	150	-	ns
Address access time	t_{AA}	-	100	-	120	-	150	ns
Output-enable access time	t_{OA}	-	60	-	70	-	80	ns
Chip-enable access time	t_{CA}	-	100	-	120	-	150	ns
Output hold time	t_{OH}	5	-	5	-	5	-	ns
Output-enable propagation delay	t_{OEH}	5	-	5	-	5	-	ns
Chip-enable propagation delay	t_{OED}	5	-	5	-	10	-	ns
Output-disable propagation delay	t_{OOD}	-	35	-	40	-	50	ns
Chip-disable propagation delay	t_{OOD}	-	35	-	40	-	50	ns

Write timing

Write cycle 1

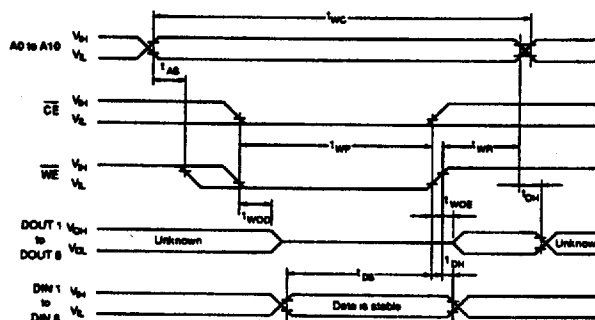

T-46-23-12

LC3517A, AM, AS, AL, AML, ASL

Write cycle 2

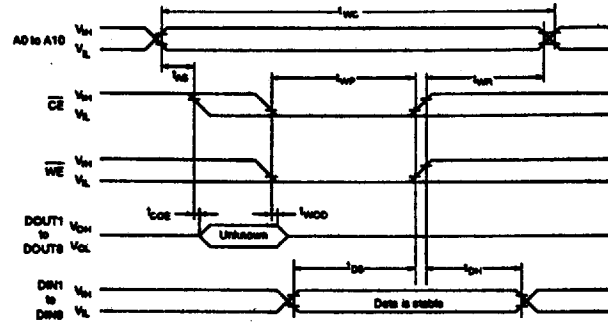

V_{CC} = 5 V ±10%, T_a = -30 to 85 deg. C

Parameter	Symbol	LC3517A/AMAS-10, LC3517AL/AML/ASL-10		LC3517A/AMAS-12, LC3517AL/AML/ASL-12		LC3517A/AMAS-15, LC3517AL/AML/ASL-15		Unit
		min	max	min	max	min	max	
Write cycle time	t _{wc}	100	-	120	-	150	-	ns
Address setup time	t _{as}	0	-	0	-	0	-	ns
Write pulsewidth	t _{wp}	75	-	95	-	120	-	ns
Write recovery time	t _{wn}	10	-	10	-	10	-	ns
Data setup time	t _{ds}	50	-	60	-	70	-	ns
Data hold time	t _{dh}	0	-	0	-	0	-	ns
Write-enable propagation delay	t _{wce}	5	-	5	-	5	-	ns
Write-disable propagation delay	t _{wod}	-	35	-	40	-	50	ns

Notes

1. Hold WE HIGH during the read cycle.
2. Do not apply opposite phase signals to DOUT when it is connected to the output bus.
3. t_{wp} can be measured when CE and WE are LOW.
4. t_{wn}, t_{ds} and t_{dh} are measured from the time when CE or WE goes HIGH.
5. DOUT becomes high impedance after either CE or OE goes HIGH, or WE goes LOW.
6. t_{as} can be measured when CE and WE go LOW.
7. DOUT is high impedance when OE is HIGH during the write cycle.
8. DOUT has the same phase as the data to be written during the write cycle.
9. DOUT holds the data readout from the next address.

Data Retention Characteristics

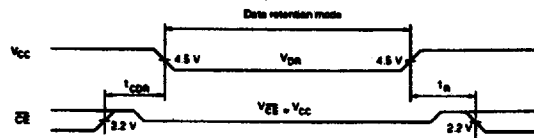

T-46-23-12

LC3517A, AM, AS, AL, AML, ASL

T_a = -30 to 85 deg. C

Parameter	Symbol	Condition	Rating			Unit	
			min	typ	max		
Data retention mode supply voltage	V _{DR}	V _{CE} = V _{CC} , V _{IN} = 0 V to V _{CC}	2.0	-	5.5	V	
Data retention mode supply current	I _{CCDR}	V _{CE} = V _{CC} , V _{CC} = 3.0 V, V _{IN} = 0 V to V _{CC} . See note 1.	T _a = 60 deg. C	-	-	4.0	μA
			T _a = 85 deg. C	-	-	20	
		V _{CE} = V _{CC} , V _{CC} = 3.0 V, V _{IN} = 0 V to V _{CC} . See note 2.	T _a = 25 deg. C	-	-	0.2	
			T _a = 60 deg. C	-	-	1.0	
Chip-enable setup time	t _{CS}		0	-	-	ns	
Chip-enable hold time	t _H		t _{CH}	-	-	ns	

Notes

1. LC3517A/AM/AS-10/12/15
2. LC3517AL/AML/ASL-10/12/15

Mode Selection

Mode	\overline{CE}	\overline{OE}	\overline{WE}	Input/output	Supply current
Reset cycle	L	L	H	Data output	I _{CCA}
Write cycle	L	X	L	Data input	I _{CCA}
Output disable	L	H	X	High impedance	I _{CCA}
Standby	H	X	X	High impedance	I _{CCS}

Note

X = don't care

Information (including circuit diagrams and circuit parameters) herein is for example only; it is not guaranteed for volume production. SANYO believes information herein is accurate and reliable, but no guarantees are made or implied regarding its use or any infringements of intellectual property rights or other rights of third parties.