



Engineering Specification

LCM ENGINEERING SPECIFICATION

*MODEL	LC420EUA
SUFFIX	AEM1
Update	Dec.15, 2011

- () Preliminary Specification
(●) Final Specification



Engineering Specification

CONTENTS

Number	ITEM	Page
	COVER	1
	CONTENTS	2
	RECORD OF REVISIONS	3
1	GENERAL DESCRIPTION	4
2	ABSOLUTE MAXIMUM RATINGS	5
3	ELECTRICAL SPECIFICATIONS	6
3-1	ELECTRICAL CHARACTERISTICS	6
3-2	INTERFACE CONNECTIONS	9
3-3	SIGNAL TIMING SPECIFICATIONS	12
3-4	Panel Pixel Structure	15
3-5	POWER SEQUENCE	16
4	OPTICAL SPECIFICATIONS	19
5	MECHANICAL CHARACTERISTICS	22
6	RELIABILITY	25
7	INTERNATIONAL STANDARDS	26
7-1	SAFETY	26
7-2	ENVIRONMENT	26
8	PRECAUTIONS	27
8-1	MOUNTING PRECAUTIONS	27
8-2	OPERATING PRECAUTIONS	27
8-3	ELECTROSTATIC DISCHARGE CONTROL	28
8-4	PRECAUTIONS FOR STRONG LIGHT EXPOSURE	28
8-5	STORAGE	28



Engineering Specification

RECORD OF REVISIONS

Revision No.	Revision Date	Page	Description
0.1	Oct 07, 2011	-	Preliminary Specification (First Draft)
1.0	Dec.15,2011	4	Power consumption(Total & LED Driver) is corrected
		4	Outline Dimension is corrected
		6	Electrical Characteristics are corrected
		13	SOE Width & Timing is corrected
		17	Optical characteristics are corrected
		22,23	Mechanical drawing is corrected
		28	Cancel US patent
		-	Final Specification



Engineering Specification

1. General Description

The LC420EUA is a Color Active Matrix Liquid Crystal Display with an integral Light Emitting Diode (LED) backlight system. The matrix employs a-Si Thin Film Transistor as the active element. It is a transmissive display type which is operating in the normally black mode. It has a 42.02inch diagonally measured active display area with WUXGA resolution (1080 vertical by 1920 horizontal pixel array). Each pixel is divided into Red, Green and Blue sub-pixels or dots which are arrayed in vertical stripes. Gray scale or the luminance of the sub-pixel color is determined with a 8-bit gray scale signal for each dot. Therefore, it can present a palette of more than 1.67M(ure) colors. It is intended to support LCD TV, PCTV where high brightness, super wide viewing angle, high color gamut, high color depth and fast response time are important.

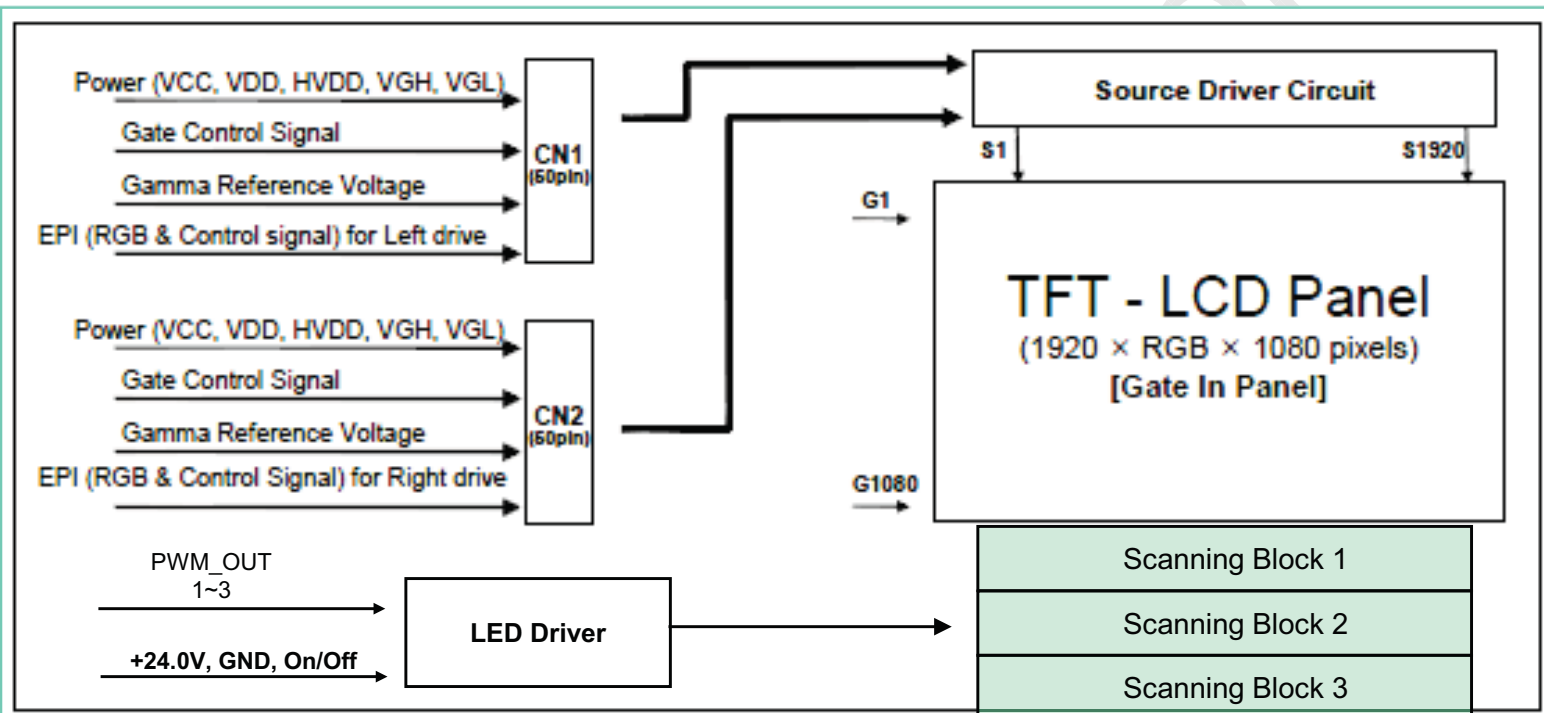

General Features

Active Screen Size	42.02inches(1067.31mm) diagonal
Outline Dimension	960.4(H) × 560.4(V)X23.1mm(D) (Typ.)
Pixel Pitch	0.4845 mm x 0.4845 mm
Pixel Format	1920 horiz. by 1080 vert. Pixels, RGB stripe arrangement
Color Depth	8bit, 16.7 Million colors
Luminance, White	360 cd/m ² (Center 1point ,Typ.)
Viewing Angle (CR>10)	Viewing angle free (R/L 178 (Min.), U/D 178 (Min.))
Power Consumption	Total 54.1W(TBD) (Typ.) [Logic=8.6W(TBD) , LED Driver=45.5W(ExtVbr_B=100%)]
Weight	7.0(TBD) Kg (Typ.)
Display Mode	Transmissive mode, Normally black
Surface Treatment	Hard coating(2H), Anti-glare treatment of the front polarizer (Haze 10%)

Engineering Specification

2. Absolute Maximum Ratings

The following items are maximum values which, if exceeded, may cause faulty operation or **permanent** damage to the LCD module.

Table 1. ABSOLUTE MAXIMUM RATINGS

Parameter	Symbol	Value		Unit	Note
		Min	Max		
Logic&EPI Power Voltage	VCC	-0.5	+2.2	VDC	1
Gate High Voltage	VGH	+18.0	+30.0	VDC	
Gate Low Voltage	VGL	-8.0	-4.0	VDC	
Source D-IC Analog Voltage	VDD	-0.3	+18.0	VDC	
Gamma Ref. Voltage (Upper)	VGMH	$\frac{1}{2}VDD-0.5$	$VDD+0.5$	VDC	
Gamma Ref. Voltage (Low)	VGML	-0.3	$\frac{1}{2}VDD+0.5$	VDC	
Panel Front Temperature	TSUR	-	+68	°C	4
Operating Temperature	TOP	0	+50	°C	2,3
Storage Temperature	TST	-20	+60	°C	
Operating Ambient Humidity	HOP	10	90	%RH	
Storage Humidity	HST	10	90	%RH	

- Note
1. Ambient temperature condition ($T_a = 25 \pm 2 \text{ }^\circ\text{C}$)
 2. Temperature and relative humidity range are shown in the figure below. Wet bulb temperature should be Max $39 \text{ }^\circ\text{C}$ and no condensation of water.
 3. Gravity mura can be guaranteed below $40 \text{ }^\circ\text{C}$ condition.
 4. The maximum operating temperature is based on the test condition that the surface temperature of display area is less than or equal to $68 \text{ }^\circ\text{C}$ with LCD module alone in a temperature controlled chamber. Thermal management should be considered in final product design to prevent the surface temperature of display area from being over $68 \text{ }^\circ\text{C}$. The range of operating temperature may degrade in case of improper thermal management in final product design.
 5. The storage test condition: $-20 \text{ }^\circ\text{C}$ temperature/90% humidity to $60 \text{ }^\circ\text{C}$ temperature/40% humidity ; the operating test condition: $0 \text{ }^\circ\text{C}$ temperature/90% humidity to $50 \text{ }^\circ\text{C}$ temperature/60% humidity.

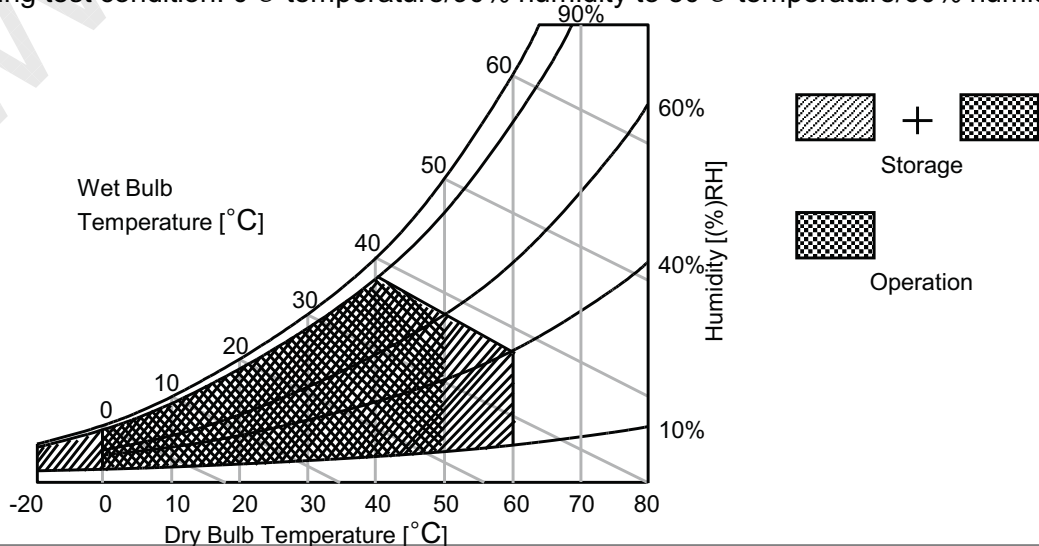



Engineering Specification

3. Electrical Specifications

It requires two kind of power inputs.

One is employed to power for the LCD circuit. The other is used for the LED backlight circuit.

3-1. Electrical Characteristics

Table 2. DC ELECTRICAL CHARACTERISTICS

Parameter	Symbol	Condition	MIN	TYP	MAX	Unit	Note
Logic & EPI Power Voltage	VCC	-	1.62	1.8	1.98	V _{DC}	
Logic High Level Input Voltage	V _{IH}	-	1.4(TBD)	-	VCC	V _{DC}	
Logic Low Level Input Voltage	V _{IL}	-	0	-	0.4(TBD)	V _{DC}	
Source D-IC Analog Voltage	VDD	-	16.5	16.7	16.9	V _{DC}	
Half Source D-IC Analog Voltage	H_VDD	-	8.15	8.35	8.55	V _{DC}	6
Gamma Reference Voltage	V _{GMH}	(GMA1 ~ GMA9)	H_VDD+0.2 (TBD)	-	VDD-0.2 (TBD)	V _{DC}	
	V _{GML}	(GMA10 ~ GMA18)	0.2	-	H_VDD-0.2V	V _{DC}	
Common Voltage	V _{com}	Reverse	6.58	6.88	7.18	V	
EPI input common voltage	V _{CM}	LVDS Type	0.8(TBD)	VCC/2	VCC-0.6- V _{diff} /2(TBD)	V	5
EPI Input eye diagram	V _{eye}	-	90(TBD)	-	-	mV	
EPI input differential voltage	V _{diff}	-	150(TBD)	-	500(TBD)	mV	
Gate High Voltage	V _{GH}	@ 25°C	27.7	28	28.3	V _{DC}	
		@ 0°C	29.7	30	30.3	V _{DC}	
Gate Low Voltage	V _{GL}	-	-5.2	-5.0	-4.8	V _{DC}	
GIP Bi-Scan Voltage	V _{GI_P} V _{GI_N}	-	V _{GL}	-	V _{GH}	V _{DC}	
GIP Refresh Voltage	V _{GH} even/odd	-	V _{GL}	-	V _{GH}	V	
GIP Start Pulse Voltage	V _{ST}	-	V _{GL}	-	V _{GH}	V	
GIP Operating Clock	G _{CLK}	-	V _{GL}	-	V _{GH}	V	
Total Power Current	I _{LCD}	-	-	528	688	mA	1
Total Power Consumption	P _{LCD}	-	-	6.34	8.23	Watt	1

Note:

1. The specified current and power consumption are under the V_{LCD}=12V., 25 ± 2°C, f_v=60Hz condition whereas mosaic pattern(8 x 6) is displayed and f_v is the frame frequency.
2. The above spec is based on the basic model.
3. All of the typical gate voltage should be controlled within 1% voltage level
4. Ripple voltage level is recommended under ±5% of typical voltage
5. In case of EPI signal spec, refer to Fig 2 for the more detail.
6. HVDD Voltage level is half of VDD and it should be between Gamma9 and Gamma10.



Engineering Specification

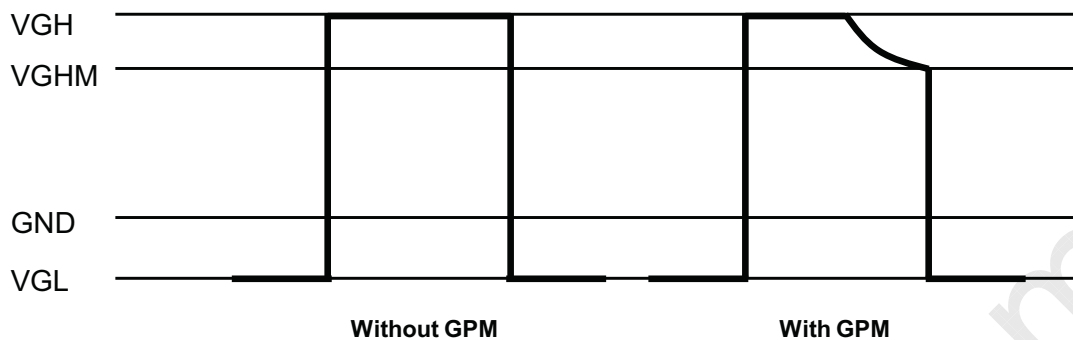

FIG. 1 Gate Output Wave form without GPM and with GPM

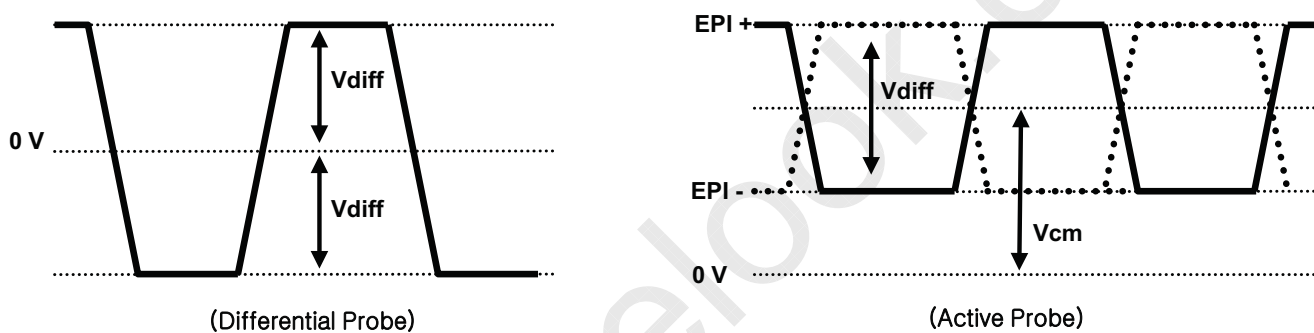

FIG. 2-1 EPI Differential signal characteristics

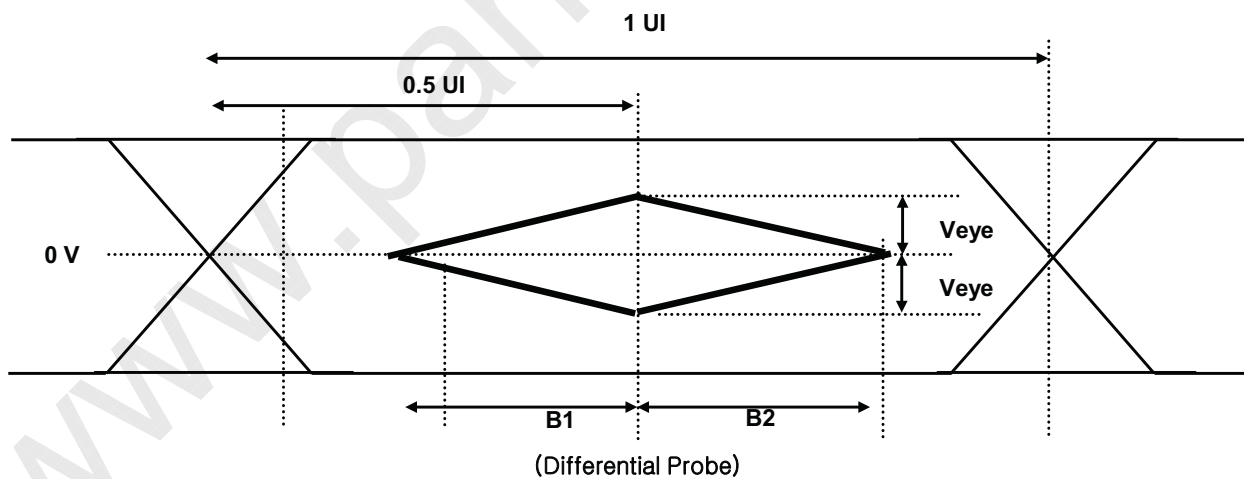

FIG. 2-2 Eye Pattern of EPI Input

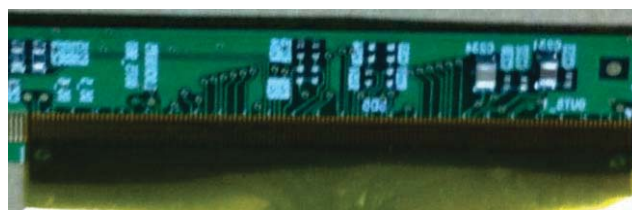

FIG. 3 Measure point



Engineering Specification

Table 3. ELECTRICAL CHARACTERISTICS (Continue)

Parameter			Symbol	Values			Unit	Notes
				Min	Typ	Max		
LED Driver :								
Power Supply Input Voltage			VBL	22.8	24.0	25.2	Vdc	1
Power Supply Input Current			IBL	-	1.9	2.1	A	1
Power Supply Input Current (In-Rush)			In-rush	-	-	3.5	A	VBL = 22.8V ExtV _{BR-B} = 100%
Power Consumption			PBL	-	45.5	49.8	W	1
Input Voltage for Control System Signals	On/Off	On	V on	2.5	-	5.0	Vdc	
		Off	V off	-0.3	0.0	0.7	Vdc	
LED :								
Life Time				30,000			Hrs	2

Notes :

1. Electrical characteristics are determined after the unit has been 'ON' and stable for approximately 60 minutes at $25\pm 2^{\circ}\text{C}$. The specified current and power consumption are under the typical supply Input voltage 24V and VBR (ExtV_{BR-B} : 100%), it is total power consumption.
2. The life time (MTTF) is determined as the time which luminance of the LED is 50% compared to that of initial value at the typical LED current (ExtV_{BR-B} : 100%) on condition of continuous operating in LCM state at $25\pm 2^{\circ}\text{C}$.



Engineering Specification

3-2. Interface Connections

This LCD module employs two kinds of interface connection, two 50-pin FFC connector are used for the module electronics.

3-2-1. LCD Module

-LCD Connector (CN1): TF06L-50S-0.5SH (Manufactured by HRS) or Compatible

Table 3-1. MODULE CONNECTOR(CN1) PIN CONFIGURATION

No	Symbol	Description	No	Symbol	Description
1	LTD_OUT	LTD OUTPUT	26	GND	Ground
2	NC	No Connection	27	EPI2-	EPI Receiver Signal(2-)
3	GCLK1	GIP GATE Clock 1	28	EPI2+	EPI Receiver Signal(2+)
4	GCLK2	GIP GATE Clock 2	29	GND	Ground
5	GCLK3	GIP GATE Clock 3	30	GND	Ground
6	GCLK4	GIP GATE Clock 4	31	EPI1-	EPI Receiver Signal(1-)
7	GCLK5	GIP GATE Clock 5	32	EPI1+	EPI Receiver Signal(1+)
8	GCLK6	GIP GATE Clock 6	33	GND	Ground
9	VGI_N	GIP Bi-Scan (Normal =VGL Rotate = VGH)	34	VCC	Logic & EPI Power Voltage
10	VGI_P	GIP Bi-Scan (Normal =VGH Rotate = VGL)	35	NC	No Connection
11	VGH_ODD	GIP Panel VDD for Odd GATE TFT	36	LOCKOUT3	LOCKOUT3
12	VGH_EVEN	GIP Panel VDD for Even GATE TFT	37	NC	No Connection
13	VGL	GATE Low Voltage	38	GND	Ground
14	VST	VERTICAL START PULSE	39	GMA 18	GAMMA VOLTAGE 18 (Output From LCD)
15	GIP_Reset	GIP Reset	40	GMA 16	GAMMA VOLTAGE 16
16	VCOM_L_FB	VCOM Left Feed-Back Output	41	GMA 15	GAMMA VOLTAGE 15
17	VCOM_L	VCOM Left Input	42	GMA 14	GAMMA VOLTAGE 14
18	GND	Ground	43	GMA 12	GAMMA VOLTAGE 12
19	VDD	Driver Power Supply Voltage	44	GMA 10	GAMMA VOLTAGE 10 (Output From LCD)
20	VDD	Driver Power Supply Voltage	45	GMA 9	GAMMA VOLTAGE 9 (Output From LCD)
21	H_VDD	Half Driver Power Supply Voltage	46	GMA 7	GAMMA VOLTAGE 7
22	GND	Ground	47	GMA 5	GAMMA VOLTAGE 5
23	EPI3-	EPI Receiver Signal(3-)	48	GMA 4	GAMMA VOLTAGE 4
24	EPI3+	EPI Receiver Signal(3+)	49	GMA 3	GAMMA VOLTAGE 3
25	GND	Ground	50	GMA 1	GAMMA VOLTAGE 1(Output From LCD)

Note :

1. Please refer to application note for details.
(GIP & Half VDD & Gamma Voltage setting)

Engineering Specification

-LCD Connector (CN1): TF06L-50S-0.5SH (Manufactured by HRS) or Compatible

Table 3-2. MODULE CONNECTOR(CN2) PIN CONFIGURATION

No	Symbol	Description	No	Symbol	Description
1	GMA 1	GAMMA VOLTAGE 1 (Output From LCD)	26	GND	Ground
2	GMA 3	GAMMA VOLTAGE 3	27	EPI1-	EPI Receiver Signal(4-)
3	GMA 4	GAMMA VOLTAGE 4	28	EPI1+	EPI Receiver Signal(4+)
4	GMA 5	GAMMA VOLTAGE 5	29	GND	Ground
5	GMA 7	GAMMA VOLTAGE 7	30	H_VDD	Half Driver Power Supply Voltage
6	GMA 9	GAMMA VOLTAGE 9 (Output From LCD)	31	VDD	Driver Power Supply Voltage
7	GMA 10	GAMMA VOLTAGE 10 (Output From LCD)	32	VDD	Driver Power Supply Voltage
8	GMA 12	GAMMA VOLTAGE 12	33	GND	Ground
9	GMA 14	GAMMA VOLTAGE 14	34	VCOM_R	VCOM Right Input
10	GMA 15	GAMMA VOLTAGE 15	35	VCOM_R_FB	VCOM Right Feed-Back Output
11	GMA 16	GAMMA VOLTAGE 16	36	GIP_Reset	GIP Reset
12	GMA 18	GAMMA VOLTAGE 18 (Output From LCD)	37	VST	VERTICAL START PULSE
13	GND	Ground	38	VGL	GATE Low Voltage
14	LOCKOUT6	LOCKOUT6	39	VGH_EVEN	GIP Panel VDD for Even GATE TFT
15	LOCKIN3	LOCKIN3	40	VGH_ODD	GIP Panel VDD for Odd GATE TFT
16	NC	No Connection	41	VGI_P	GIP Bi-Scan (Normal =VGH Rotate = VGL)
17	VCC	Logic & EPI Power Voltage	42	VGI_N	GIP Bi-Scan (Normal =VGL Rotate = VGH)
18	GND	Ground	43	GCLK6	GIP GATE Clock 6
19	EPI6-	EPI Receiver Signal(6-)	44	GCLK5	GIP GATE Clock 5
20	EPI6+	EPI Receiver Signal(6+)	45	GCLK4	GIP GATE Clock 4
21	GND	Ground	46	GCLK3	GIP GATE Clock 3
22	GND	Ground	47	GCLK2	GIP GATE Clock 2
23	EPI5-	EPI Receiver Signal(5-)	48	GCLK1	GIP GATE Clock 1
24	EPI5+	EPI Receiver Signal(5+)	49	NC	No Connection
25	GND	Ground	50	LTD_OUT	LTD OUTPUT

Note : 1. Please refer to application note for details.
(GIP & Half VDD & Gamma Voltage setting)



Engineering Specification

3-2-2. Backlight Module

Master

-LED Driver Connector

: 20022WR - H14B2(Yeonho) or compatible

- Mating Connector

: 20022HS - 14B2 or compatible

Table 5-1. LED DRIVER CONNECTOR PIN CONFIGURATION

Pin No	Symbol	Description	Note
1	VBL	Power Supply +24.0V	
2	VBL	Power Supply +24.0V	
3	VBL	Power Supply +24.0V	
4	VBL	Power Supply +24.0V	
5	VBL	Power Supply +24.0V	
6	GND	Backlight Ground	
7	GND	Backlight Ground	
8	GND	Backlight Ground	1
9	GND	Backlight Ground	
10	GND	Backlight Ground	
11	Status	Back Light Status	2
12	VON/OFF	Backlight ON/OFF control	
13	NC	Don't care	
14	NC	Don't care	

Notes :1. GND should be connected to the LCD module's metal frame.

2. Normal : Low (under 0.7V) / Abnormal : **Open**

◆ Rear view of LCM

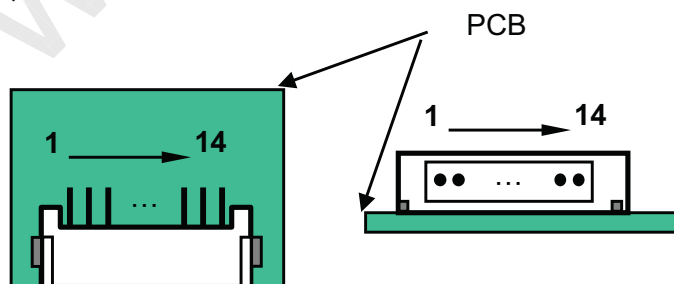

<Master>

Engineering Specification

3-2-2. Backlight Module

LED Driver Connector

: 10031HR-H04L_Black (YEONHO)

Table 5-2. LED DRIVER CONNECTOR PIN CONFIGURATION

Pin No	Symbol	Description	Note
1	GND	Ground	1
2	SCAN3	PWM 3	
3	SCAN2	PWM 2	
4	SCAN1	PWM 1	

Notes :1. GND should be connected to the LCD module's metal frame.

◆ Rear view of LCM

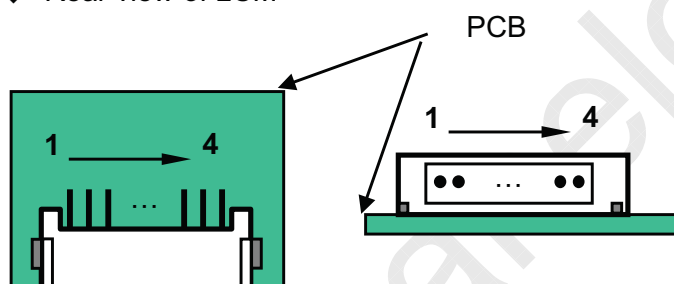

Engineering Specification

3-3. Signal Timing Specifications

Table 4. Timing Requirements

Parameter	Symbol	Condition	Min	Typ	Max	Unit	Note
Unit Interval	UI	-	0.59(TBD)	-	-	ns	
DLL Lock time	Tlock	-	1.6(TBD)	-	200(TBD)	Us	Fig 4
Effective Veye width time	B1&B2	-	0.25(TBD)	-	-	UI	Fig. 2
SSC	Vspread	@100KHz	-	-	2(TBD)	%	
Receiver off to SOE rising time	tSOE_ Rising		5(TBD)	-	-	Packet	Fig.5
SOE pulse width	tSOE_ Width	-	4(TBD)	-	-	Packet	Fig.5
SOE rising to 1 st data time	tSOE_ DATA	-	5(TBD)	-	-	Packet	Fig.5
EPI Bandwidth		-	0.607(TBD)	-	0.728(TBD)	GBPS	

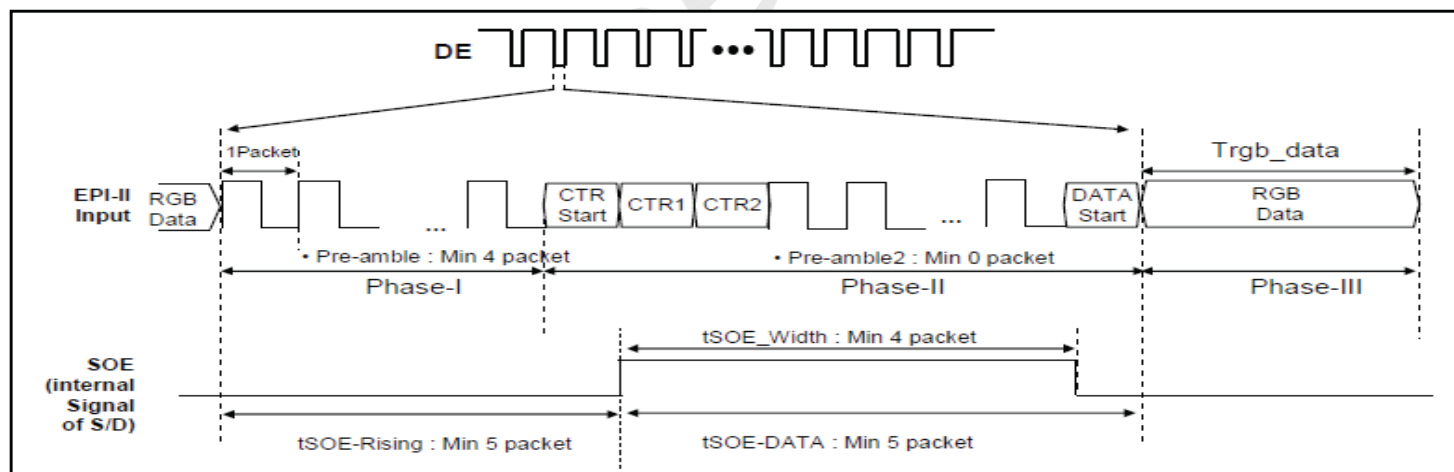

FIG 4. SOE Width & Timing

Engineering Specification

3-4. Panel Pixel Structure

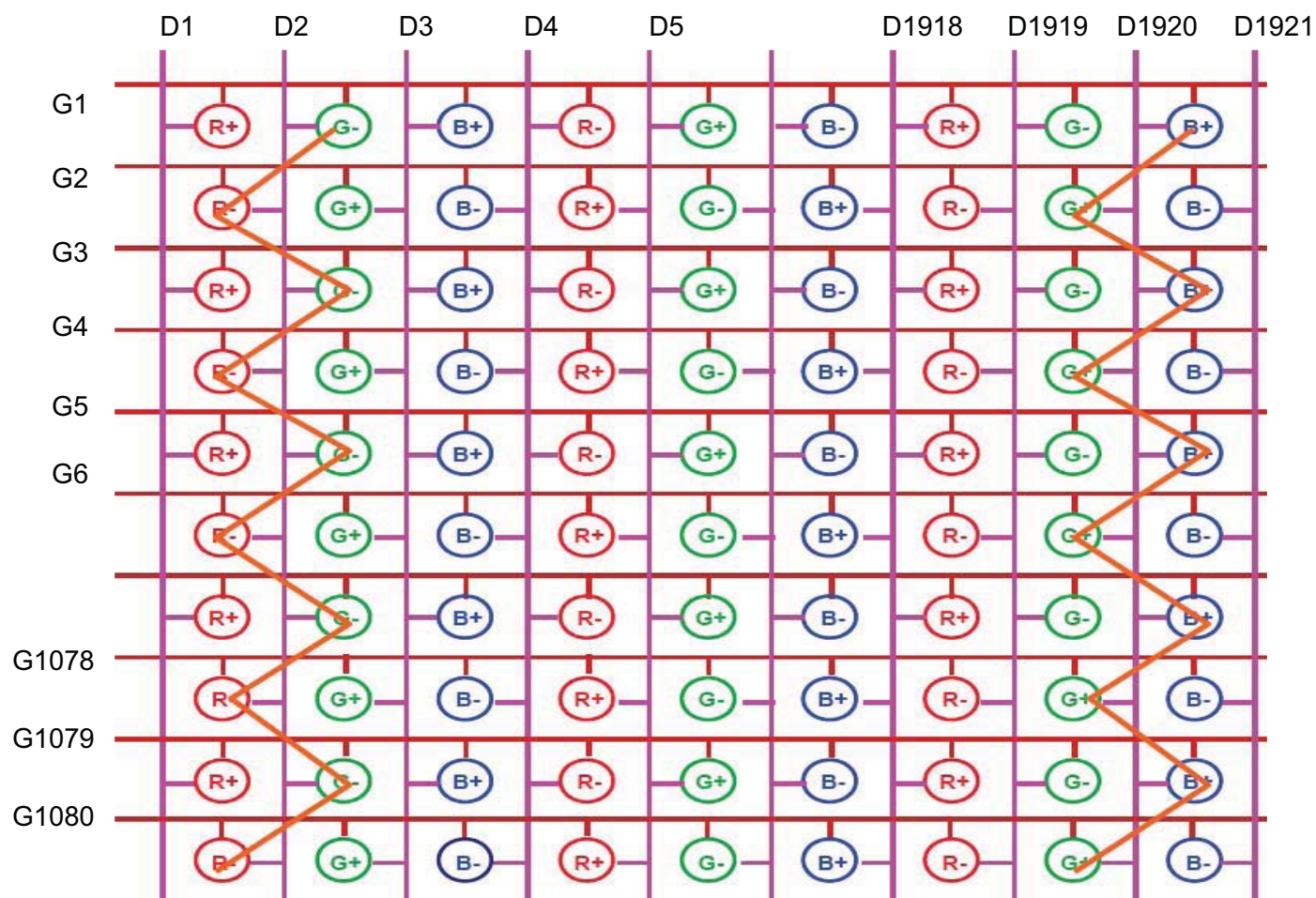

FIG. 6 Panel Pixel Structure



LC420EUA

Engineering Specification

3-7. Power Sequence

3-7-1. LCD Driving circuit

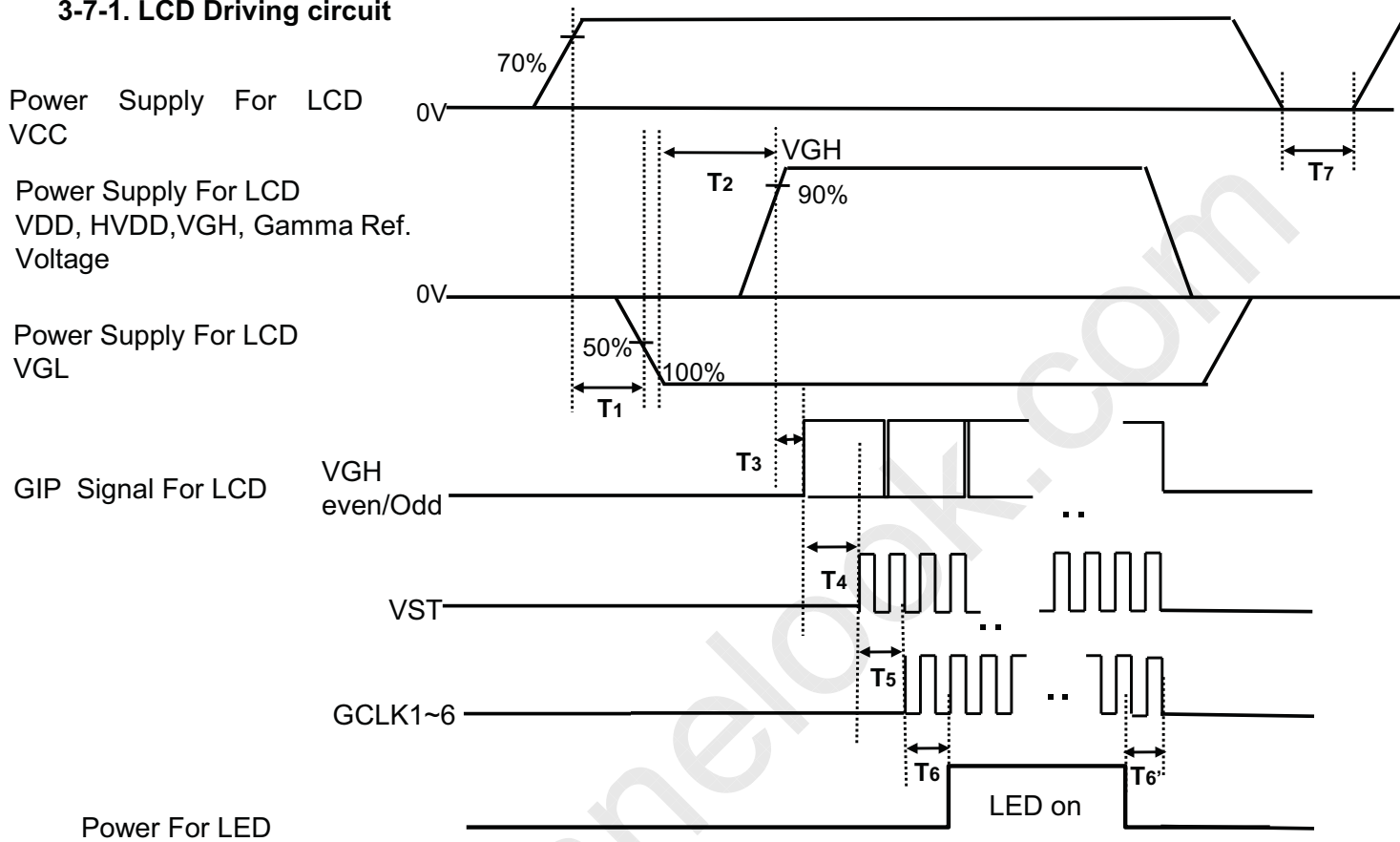

Table 9. POWER SEQUENCE

Ta= 25±2°C, fv=60Hz

Parameter	Value			Unit	Notes
	Min	Typ	Max		
T1	0.5		-	ms	
T2	0.5		-	ms	
T3	0		-	ms	
T4	10		-	ms	2
T5	0		-	ms	
T6 / T6'	20		-	ms	6
T7	2		-	sec	

Note : 1. Power sequence for Source D-IC must follow the Case1 & 2.

※ Please refer to Appendix III for more details.

2. VGH Odd signal should be started "High" status and VGH even & odd can not be "High at the same time.

3. Power Off Sequence order is reverse of Power On Condition including Source D-IC.

4. GCLK On/Off Sequence

Normal : GCLK4 → GCLK5 → GCLK6 → GCLK1 → GCLK2 → GCLK3.

Reverse : GCLK3 → GCLK2 → GCLK1 → GCLK6 → GCLK5 → GCLK4.

5. VDD_odd/even transition time should be within V_blank

6. In case of T6', If there is no abnormal display, no problem

Engineering Specification

3-7. Power Sequence

3-7-2. Sequence for LED Driver

Power Supply For LED Driver

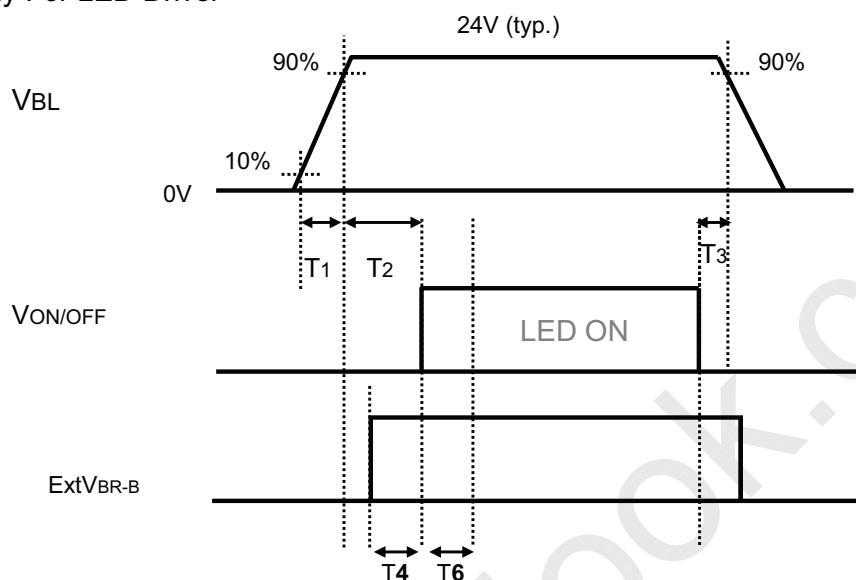

3-6-3. Dip condition for LED Driver

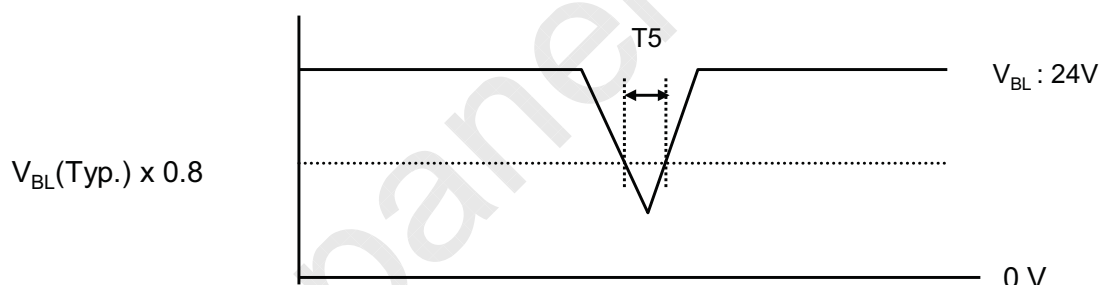

Table 9. Power Sequence for LED Driver

Parameter	Values			Units	Remarks
	Min	Typ	Max		
T1	20	-	-	ms	1
T2	500	-	-	ms	
T3	10	-	-	ms	
T4	0	-	-	ms	
T5	-	-	10	ms	$V_{BL}(Typ) \times 0.8$
T6	500	-	-	ms	2

Notes : 1. T1 describes rising time of 0V to 24V and this parameter does not applied at restarting time.

Even though T1 is over the specified value, there is no problem if I²T spec of fuse is satisfied.

2. In T6 section, ExtVBR-B should be sustained from 5% to 100% .

Engineering Specification

4. Optical Specification

Optical characteristics are determined after the unit has been 'ON' and stable in a dark environment at $25\pm 2^{\circ}\text{C}$. The values are specified at distance 50cm from the LCD surface at a viewing angle of Φ and θ equal to 0° .

FIG. 8 shows additional information concerning the measurement equipment and method.

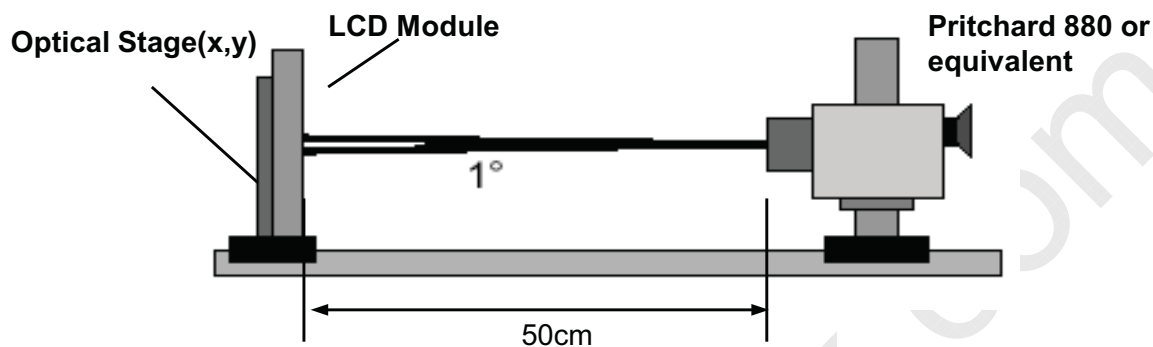

FIG. 8 Optical Characteristic Measurement Equipment and Method

$T_a = 25\pm 2^{\circ}\text{C}$, $V_{\text{LCD}} = 12.0\text{V}$, $f_v = 60\text{Hz}$, $D_{\text{clk}} = 74.25\text{MHz}$,

$\text{EXTV}_{\text{BR-B}} = 100\%$

Table 10. OPTICAL CHARACTERISTICS

Parameter		Symbol	Value			Unit	Note	
			Min	Typ	Max			
Contrast Ratio		CR	1000	1400	-		1	
Surface Luminance, white		L_{WH} 2D	290	360		cd/m ²	2	
Luminance Variation		δ_{WHITE} 5P			1.3		3	
Response Time	Variation	Rising	-	8	12		5	
	Gray to Gray (BW)	Falling	-	10	14	ms	4	
Color Coordinates [CIE1931]	RED	Rx		0.635				
		Ry		0.341				
	GREEN	Gx		0.320				
		Gy	Typ -0.03	0.598	Typ +0.03			
	BLUE	Bx		0.154				
		By		0.048				
	WHITE	Wx		0.279				
	Wy		0.292					
Color Temperature				10,000		K		
Color Gamut				68		%		
Viewing Angle	2D (CR>10)	right($\phi=0^{\circ}$)	θ_r (x axis)	89	-	-	degree	6
		left($\phi=180^{\circ}$)	θ_l (x axis)	89	-	-		
		up($\phi=90^{\circ}$)	θ_u (y axis)	89	-	-		
		down($\phi=270^{\circ}$)	θ_d (y axis)	89	-	-		
Gray Scale				-	-	-		7



Engineering Specification

Note : 1. Contrast Ratio(CR) is defined mathematically as :

$$\text{Contrast Ratio} = \frac{\text{Surface Luminance with all white pixels}}{\text{Surface Luminance with all black pixels}}$$

It is measured at center 1-point.

2. Surface luminance are determined after the unit has been 'ON' and 1 Hour after lighting the backlight in a dark environment at $25 \pm 2^\circ\text{C}$. Surface luminance is the luminance value at center 1-point across the LCD surface 50cm from the surface with all pixels displaying white. For more information see the FIG. 9.

3. The variation in surface luminance , δ WHITE is defined as :

$$\delta \text{ WHITE}(5P) = \text{Maximum}(L_{on1}, L_{on2}, L_{on3}, L_{on4}, L_{on5}) / \text{Minimum}(L_{on1}, L_{on2}, L_{on3}, L_{on4}, L_{on5})$$

Where L_{on1} to L_{on5} are the luminance with all pixels displaying white at 5 locations .

For more information, see the FIG. 9.

4. Response time is the time required for the display to transit from G(N) to G(M) (Rise Time, Tr_R) and from G(M) to G(N) (Decay Time, Tr_D). For additional information see the FIG. 10. ($N < M$)

5. Viewing angle is the angle at which the contrast ratio is greater than 10. The angles are determined for the horizontal or x axis and the vertical or y axis with respect to the z axis which is normal to the LCD module surface. For more information, see the FIG. 11.

6. Gray scale specification

Gamma Value is approximately 2.2. For more information, see the Table 11.

Table 11. GRAY SCALE SPECIFICATION

Gray Level	Luminance [%] (Typ)
L0	TBD
L15	0.27
L31	1.04
L47	2.49
L63	4.68
L79	7.66
L95	11.5
L111	16.1
L127	21.6
L143	28.1
L159	35.4
L175	43.7
L191	53.0
L207	63.2
L223	74.5
L239	86.7
L255	100

Engineering Specification

Measuring point for surface luminance & measuring point for luminance variation.

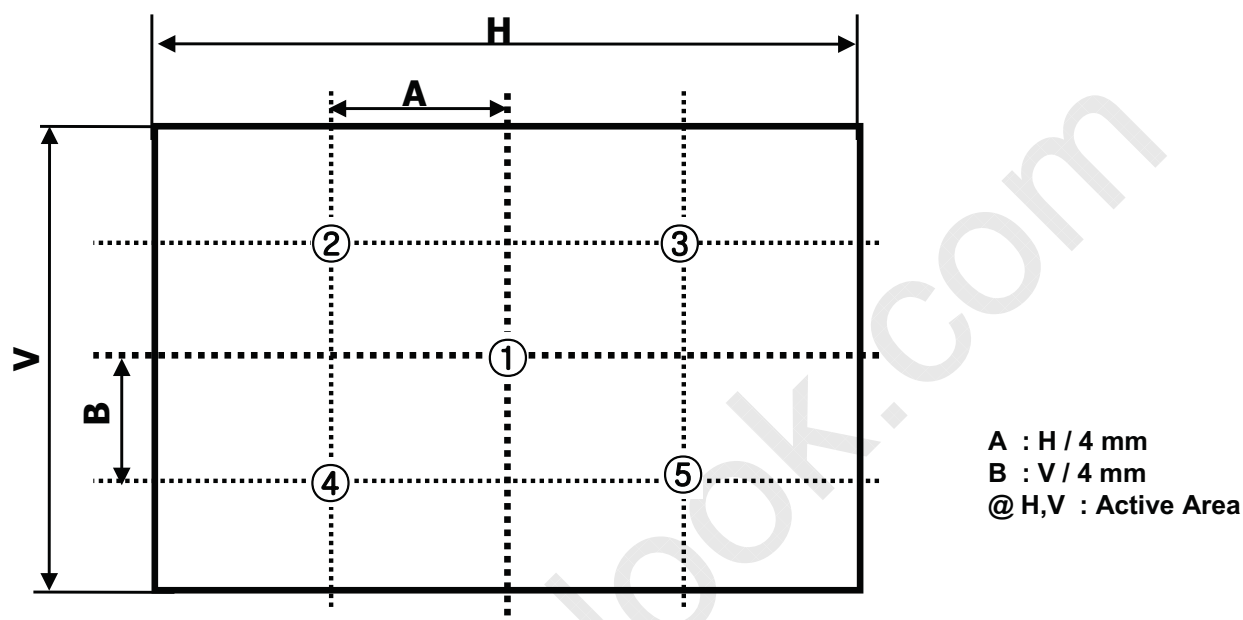

FIG.9 5 Points for Luminance Measure

Response time is defined as the following figure and shall be measured by switching the input signal for "Gray(N)" and "Gray(M)".

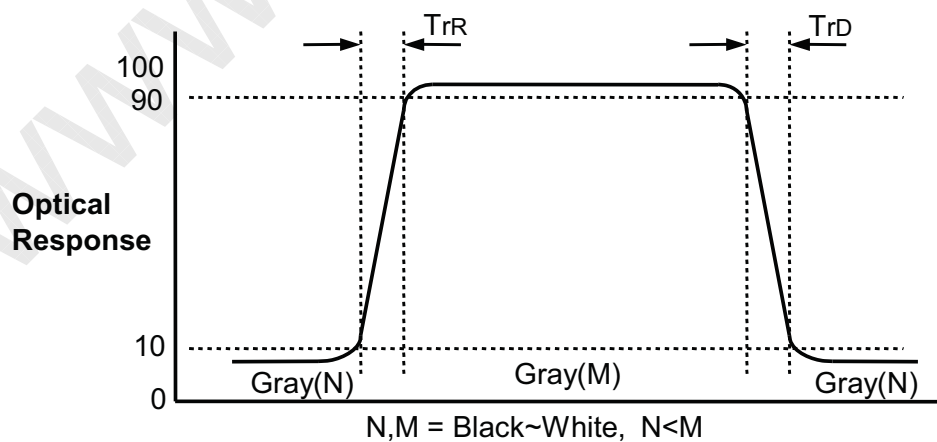

FIG. 10 Response Time

Engineering Specification

Dimension of viewing angle range

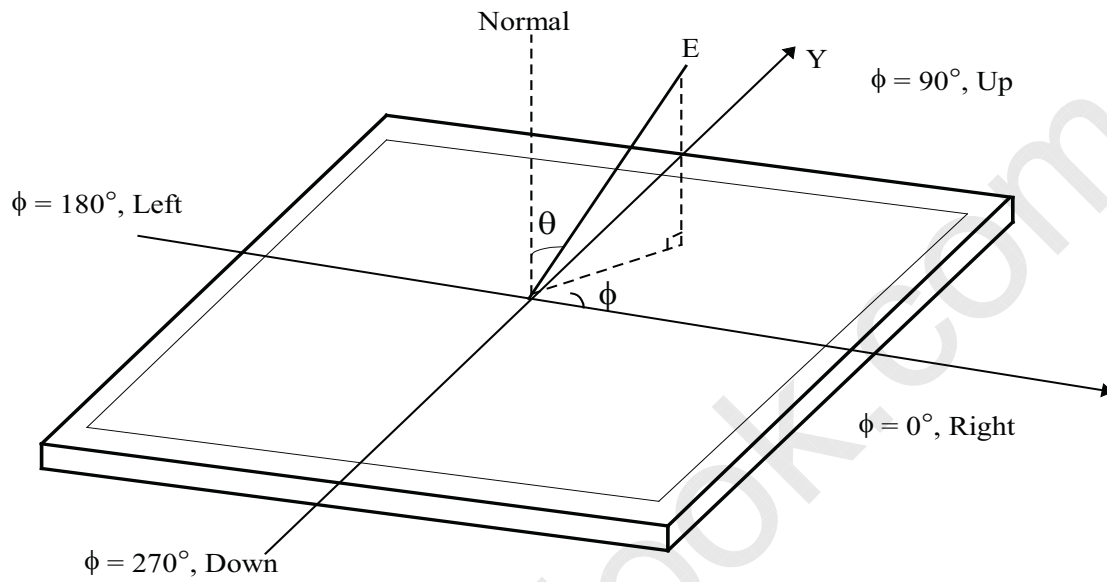

FIG. 11 Viewing Angle



Engineering Specification

5. Mechanical Characteristics

Table 12 provides general mechanical characteristics.

Table 12. MECHANICAL CHARACTERISTICS

Item	Value	
Outline Dimension	Horizontal	960.4 mm
	Vertical	560.0 mm
	Depth	16.2 mm
Bezel Area	Horizontal	938.6 mm (*1)
	Vertical	531.5 mm
Active Display Area	Horizontal	930.24 mm
	Vertical	523.26 mm
Weight	7.0 Kg (Typ.), 7.4 kg (Max.)	

Note : Please refer to a mechanical drawing in terms of tolerance at the next page.



LC420EUA

Engineering Specification

[FRONT VIEW]

Set : Top



Set : Down

NOTES

- 1. UNSPECIFIED TOLERANCE IS ±1.0MM
- 2. TILT AND PARTIAL DISPOSITION TOLERANCE OF DISPLAY AREA AS FOLLOWING.
 - (1) Y-DIRECTION: | A-B | ≤1.5
 - (2) X-DIRECTION: | C-D | ≤1.5

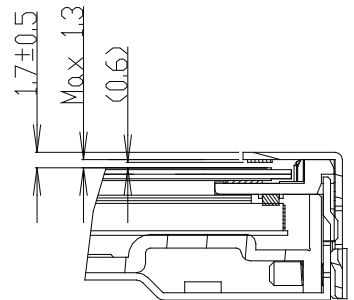
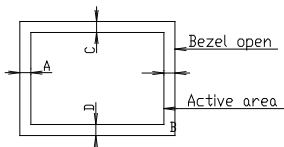

Engineering Specification

[REAR VIEW]

Set : Top

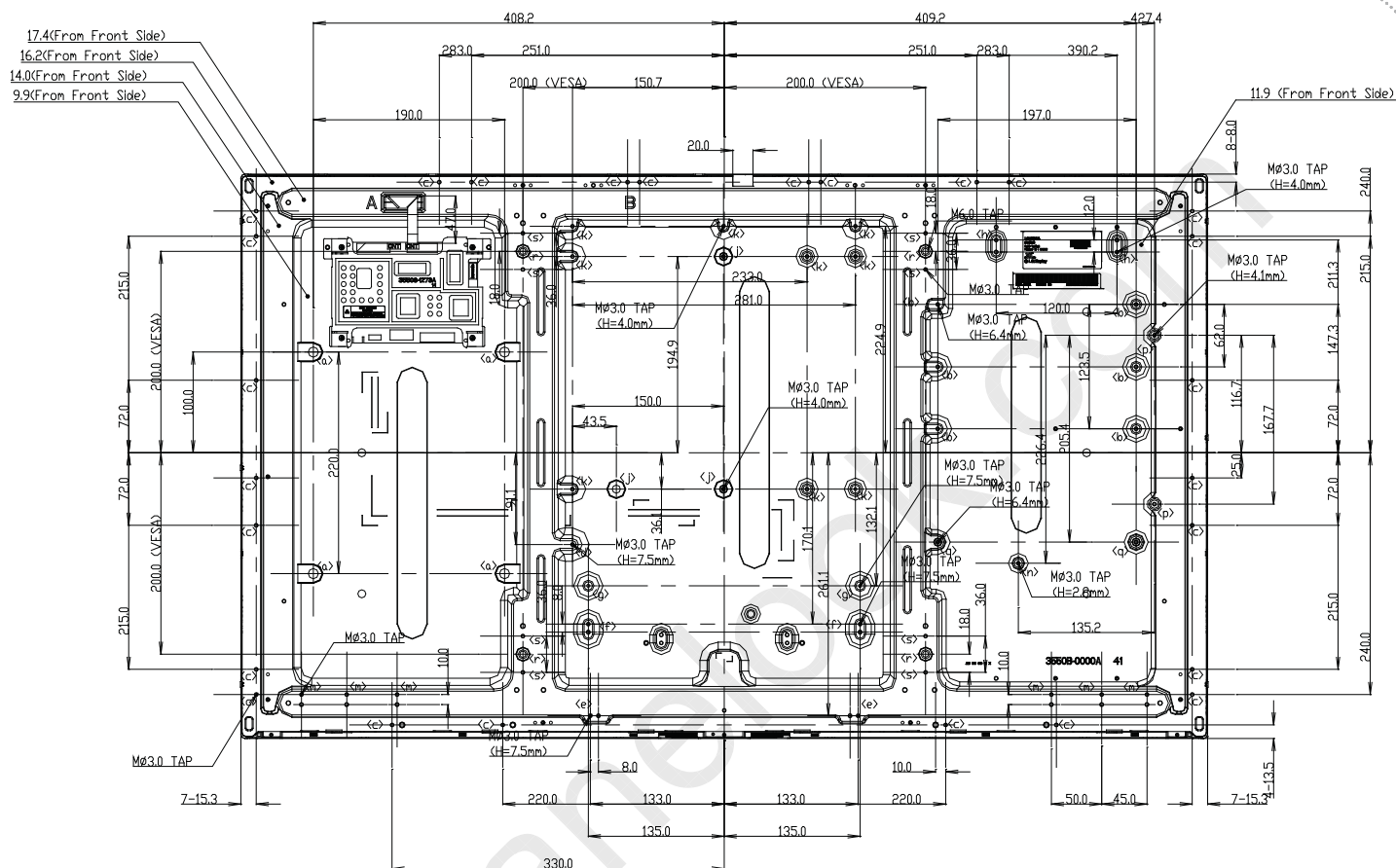

Set : Down

ITEM	TAP	Max Depth (mm)	Torque (Kgf.cm)	Notes
<a>	M3	MAX 10.0	MAX 8.0	
	M3	MAX 6.0	MAX 8.0	
<c>	M3	MAX 5.0	MAX 8.0	
<d>	M3	MAX 7.0	MAX 8.0	
<e>	M4	MAX 7.0	MAX 10.0	
<f>	M4	MAX 7.0	MAX 10.0	
<g>	M4	MAX 7.0	MAX 10.0	
<h>	M4	MAX 3.5	MAX 10.0	
<j>	M3	MAX 4.5	MAX 8.0	
<k>	M3	MAX 4.5	MAX 8.0	
<m>	M3	MAX 7.0	MAX 8.0	
<n>	M3	MAX 4.0	MAX 8.0	
<p>	M3	MAX 3.5	MAX 8.0	
<q>	M3	MAX 6.0	MAX 8.0	
<r>	M6	MAX 12.0		
<s>	M3	MAX 7.0	MAX 8.0	



Engineering Specification

6. Reliability

Table 13. ENVIRONMENT TEST CONDITION

No.	Test Item	Condition
1	High temperature storage test	Ta= 60°C 240h
2	Low temperature storage test	Ta= -20°C 240h
3	High temperature operation test	Ta= 50°C 50%RH 240h
4	Low temperature operation test	Ta= 0°C 240h
5	Humidity condition Operation	Ta= 40 °C ,90%RH

Note : Before and after Reliability test, LCM should be operated with normal function.



Engineering Specification

7. International Standards

7-1. LED Array - Safty

1. Laser (LED Backlight) Information

Class 1M LED Product IEC60825-1 : 2001 Embedded LED Power (Class 1M)
--

2. Caution

: LED inside.

Class 1M laser (LEDs) radiation when open.

Do not open while operating.

7-2. Environment

- a) RoHS, Directive 2002/95/EC of the European Parliament and of the council of 27 January 2003



Engineering Specification

8. Precautions

Please pay attention to the followings when you use this TFT LCD module.

8-1. Mounting Precautions

- (1) You must mount a module using specified mounting holes (Details refer to the drawings).
- (2) You should consider the mounting structure so that uneven force (ex. Twisted stress) is not applied to the module. And the case on which a module is mounted should have sufficient strength so that external force is not transmitted directly to the module.
- (3) Please attach the surface transparent protective plate to the surface in order to protect the polarizer. Transparent protective plate should have sufficient strength in order to resist external force.
- (4) You should adopt radiation structure to satisfy the temperature specification.
- (5) Acetic acid type and chlorine type materials for the cover case are not desirable because the former generates corrosive gas of attacking the polarizer at high temperature and the latter causes circuit break by electro-chemical reaction.
- (6) Do not touch, push or rub the exposed polarizers with glass, tweezers or anything harder than HB pencil lead. And please do not rub with dust clothes with chemical treatment. Do not touch the surface of polarizer for bare hand or greasy cloth.(Some cosmetics are detrimental to the polarizer.)
- (7) When the surface becomes dusty, please wipe gently with absorbent cotton or other soft materials like chamois soaks with petroleum benzene. Normal-hexane is recommended for cleaning the adhesives used to attach front / rear polarizers. Do not use acetone, toluene and alcohol because they cause chemical damage to the polarizer
- (8) Wipe off saliva or water drops as soon as possible. Their long time contact with polarizer causes deformations and color fading.
- (9) Do not open the case because inside circuits do not have sufficient strength.

8-2. Operating Precautions

- (1) The spike noise causes the mis-operation of circuits. It should be lower than following voltage :
 $V = \pm 200\text{mV}$ (Over and under shoot voltage)
- (2) Response time depends on the temperature.(In lower temperature, it becomes longer.)
- (3) Brightness depends on the temperature. (In lower temperature, it becomes lower.)
And in lower temperature, response time(required time that brightness is stable after turned on) becomes longer
- (4) Be careful for condensation at sudden temperature change. Condensation makes damage to polarizer or electrical contacted parts. And after fading condensation, smear or spot will occur.
- (5) When fixed patterns are displayed for a long time, remnant image is likely to occur.
- (6) Module has high frequency circuits. Sufficient suppression to the electromagnetic interference shall be done by system manufacturers. Grounding and shielding methods may be important to minimized the interference.
- (7) Please do not give any mechanical and/or acoustical impact to LCM. Otherwise, LCM can't be operated its full characteristics perfectly.
- (8) A screw which is fastened up the steels should be a machine screw.
(if not, it can causes conductive particles and deal LCM a fatal blow)
- (9) Please do not set LCD on its edge.
- (10) The conductive material and signal cables are kept away from LED driver inductor to prevent abnormal display, sound noise and temperature rising.



Engineering Specification

8-3. Electrostatic Discharge Control

Since a module is composed of electronic circuits, it is not strong to electrostatic discharge. Make certain that treatment persons are connected to ground through wrist band etc. And don't touch interface pin directly.

8-4. Precautions for Strong Light Exposure

Strong light exposure causes degradation of polarizer and color filter.

8-5. Storage

When storing modules as spares for a long time, the following precautions are necessary.

- (1) Store them in a dark place. Do not expose the module to sunlight or fluorescent light. Keep the temperature between 5°C and 35°C at normal humidity.
- (2) The polarizer surface should not come in contact with any other object.
It is recommended that they be stored in the container in which they were shipped.
- (3) Storage condition is guaranteed under packing conditions.
- (4) The phase transition of Liquid Crystal could be recovered if the LCM is released at the normal condition after the low or over the storage temperature.

8-6. Handling Precautions for Protection Film

- (1) The protection film is attached to the bezel with a small masking tape.
When the protection film is peeled off, static electricity is generated between the film and polarizer.
This should be peeled off slowly and carefully by people who are electrically grounded and with well ion-blown equipment or in such a condition, etc.
- (2) When the module with protection film attached is stored for a long time, sometimes there remains a very small amount of glue still on the bezel after the protection film is peeled off.
- (3) You can remove the glue easily. When the glue remains on the bezel surface or its vestige is recognized, please wipe them off with absorbent cotton waste or other soft material like chamois soaked with normal-hexane.

9-7. Operating condition guide

- (1) The LCD product should be operated under normal conditions. Normal condition is defined as below;
 - Temperature : 5 ~ 40 °C
 - Display pattern : continually changing pattern (Not stationary)
- (2) If the product will be used in extreme conditions such as high temperature, display patterns or operation time etc.,
It is strongly recommended to contact LGD for Qualification engineering advice. Otherwise, its reliability and function may not be guaranteed. Extreme conditions are commonly found at Airports, Transit Stations, Banks, Stock market, and Controlling systems. The LCD product should be applied by global standard environment. (refer ETSI EN 300, IEC 60721)



LC420EUA

APPENDIX- I

■ LCM Label

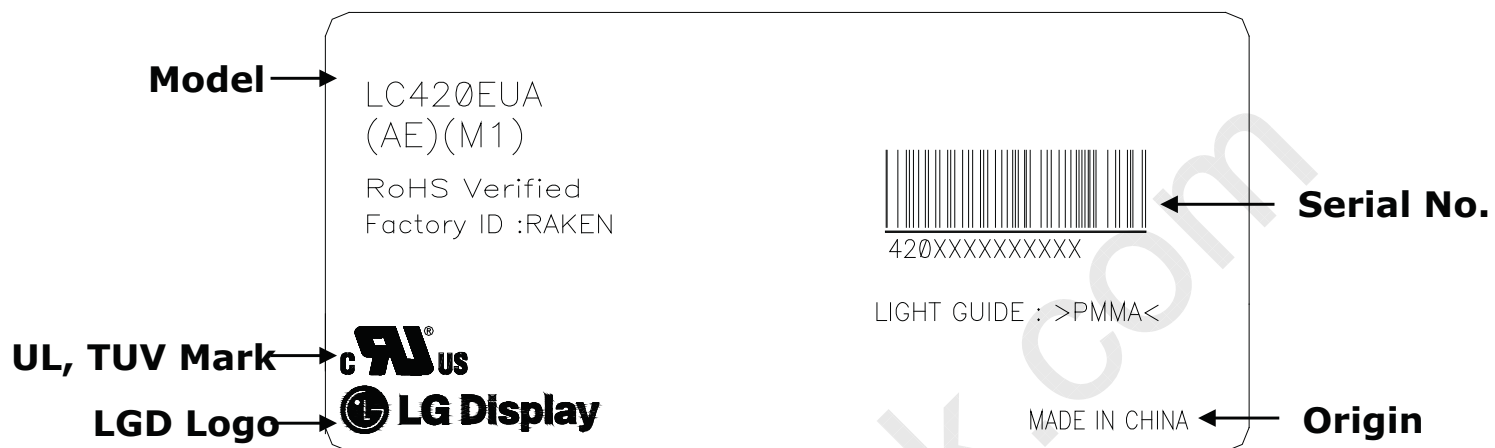

Engineering Specification

APPENDIX- II

■ LCM Source power sequence

< Source power sequence >

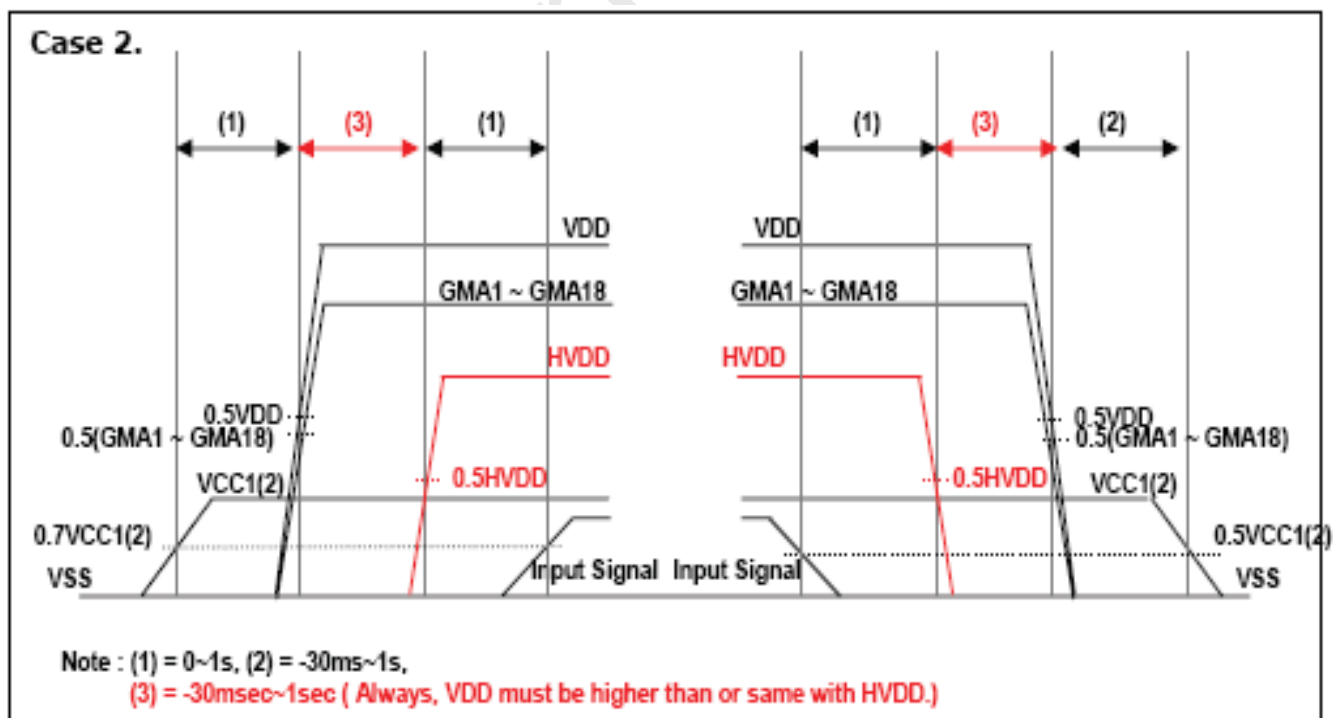
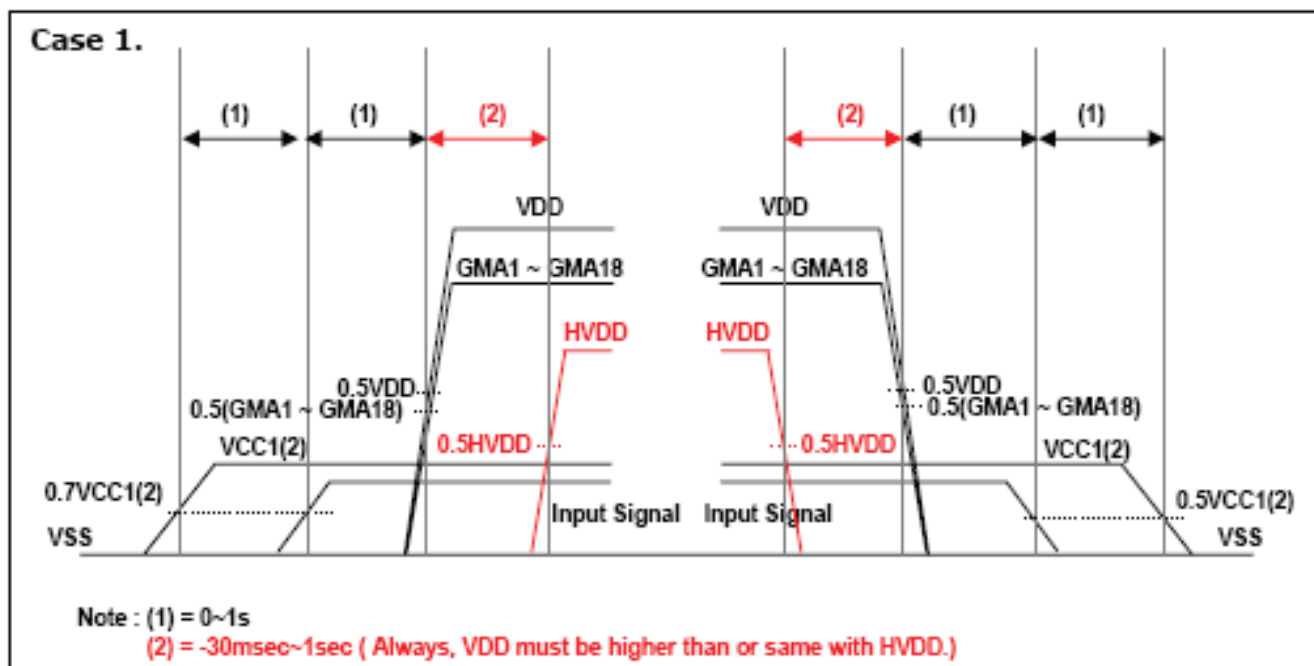

- Input Signal : SOE,POL,GSP,H_CONV,OPT_N