

LC5006

INTEGRATED HALF-BRIDGE DRIVER

Description

The LC5006 is an integrated high-speed half bridge power MOSFET driver. Our proprietary DBiCMOS technologies provide stable operation under high dv/dt noise circumstances. The output drivers feature a high pulse current buffer stage designed for minimum driver cross-conduction. The floating channel can be used to drive an N-channel power MOSFET on the high side. The logic input is compatible with standard CMOS or LSTTL, down to 3.3V logic. Cross conduction prevention logic and dead-times are built in to simplify the applications.

Features

- DBiCMOS technologies, low power dissipation and high output current
- Internal 5V LDO, CMOS and LSTTL logic (5V and 3.3V) compatible
- Cross conduction prevention logic
- Gate drive supply range from 10V to 15V
- Internal set deadtime
- High side output of phase with HIN input
- Low side output of phase with LIN input.

Ordering Information

LC5006 [1](#) [2](#) [3](#)

Code	Description
1	Temperature&Rohs: C: -40~85°C ,Pb Free Rohs Std.
2	Package type: D8: SOIC-8
3	Packing type: TR: Tape&Reel (Standard)

Marking Information

Product Classification		LC5006CD8TR
Marking		
DM NN B YY	DB: Product Code	
	NN: LOT NO.	
	B: FAB Code	
	YY: Date Code	

Lead Assignments

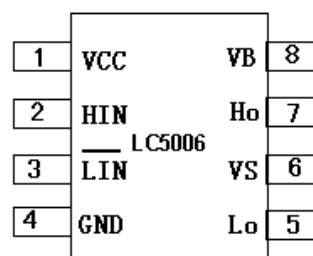

Pin Descriptions

Symbol	Description
HIN	Logic input for high side gate driver output (H _O), in phase
$\overline{\text{LIN}}$	Logic input for low side gate driver output (L _O), out of phase
V _B	High side floating supply
H _O	High side gate drive output
V _S	High side floating supply return
V _{CC}	Low side and logic fixed supply
L _O	Low side gate drive output
GND	Low side return

Functional Block Diagram

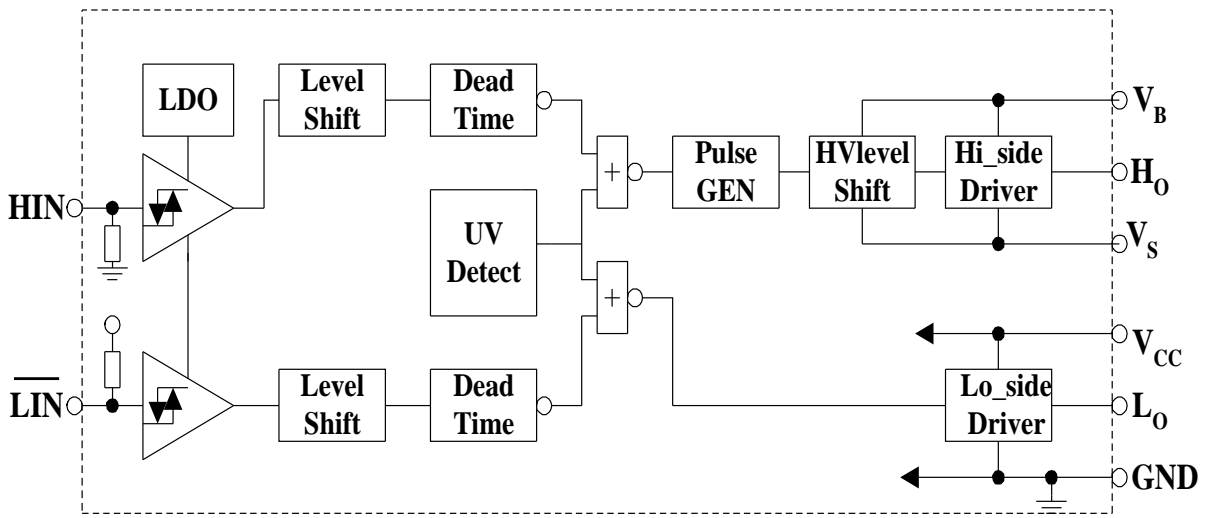

Typical Connection

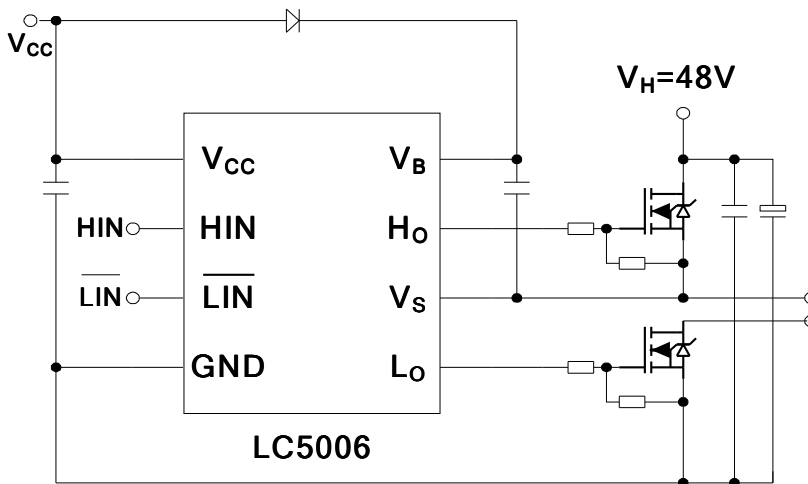

Absolute Maximum Ratings

Symbol	Definition	Min.	Max.	Unit
V _{CC}	Low side and logic fixed supply voltage	-0.3	16	V
V _B	High side floating absolute voltage	-0.3	100	V
V _S	High side floating supply offset voltage	V _B -16	V _B +0.3	V
P _D	Package power dissipation @ T _A ≤+25°C		0.625	W
R _{thJA}	Thermal resistance, junction to ambient		200	°C/W

Recommended Operating Conditions

Symbol	Min.	Typ.	Max.	Units
V _B	V _S +10	V _S +12	V _S +15	V
V _S	Note1		80	V
V _{HO}	V _S		V _B	V
V _{CC}	10	12	15	V
V _H	V _{CC}	48	80	V
T _A	-40		125	°C

Note 1: Logic operational for V_S of -5 to 80V.

Electrical Characteristics

V_{BIAS} (V_{CC}, V_{BS})=12V, unless specified otherwise.

Symbol	Definition	Min	Typ	Max	Unit	Test Conditions
V _{IH}	Logic "1" (HIN) & "0" (LIN) input voltage	3			V	V _{CC} =10 to 15V
V _{IL}	Logic "0" (HIN) & "1" (LIN) input voltage			0.8	V	V _{CC} =10 to 15V
V _{OH}	High level output voltage, V _{BIAS} -V _O			100	mV	I _O =0A
V _{OL}	Low level output Voltage, V _O			100	mV	I _O =0A
I _{QCC}	Quiescent V _{CC} supply current	50	100	150	uA	V _{CC} =15V
V _{CC_uv+}	V _{CC} supply undervoltage positive going threshold		9.1		V	
V _{CC_uv-}	V _{CC} supply undervoltage negative going threshold		8.3		V	
I _{QBS}	Quiescent V _{BS} supply current	0	25	55	uA	
I _{LK}	V _S to GND leakage current	0	10	50	nA	V _S =48V
I _{O+}	Peak source output current	130	210		mA	C _L =10nF
I _{O-}	Peak sink output current	300	430		mA	
DT	Deadtime	500	600	700	nS	

Input/output True table

Hin	$\overline{\text{Lin}}$	Ho	Lo
0	0	0	1
0	1	0	0
1	0	0	0
1	1	1	0

Input/output Timing Diagram

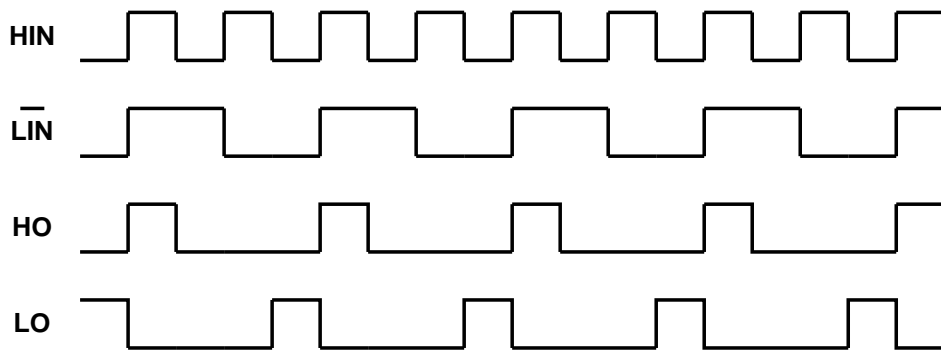

Figure 1: Input/output Timing Diagram

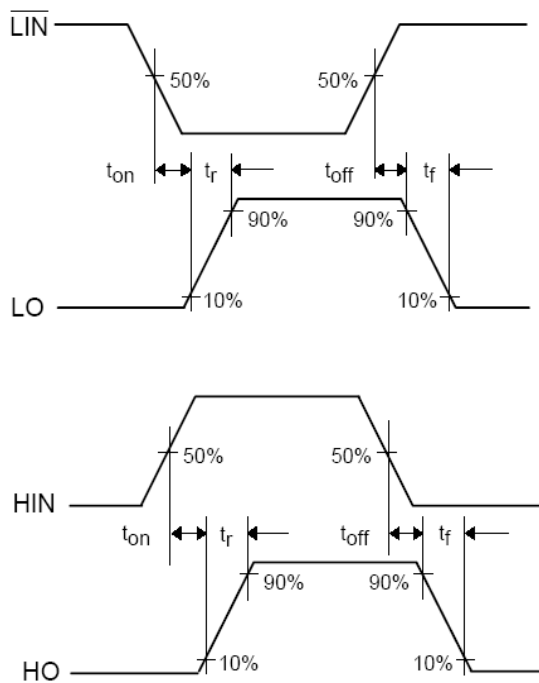

Figure 2: Switch Time Definition

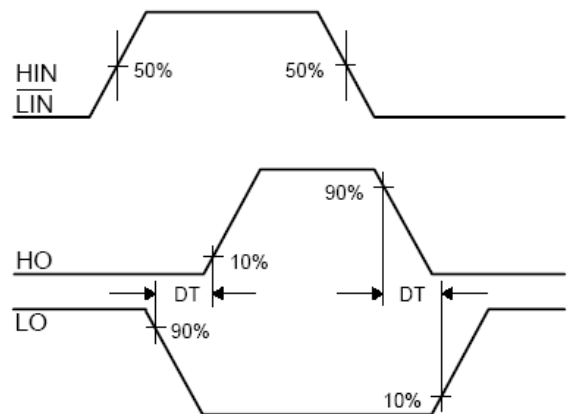
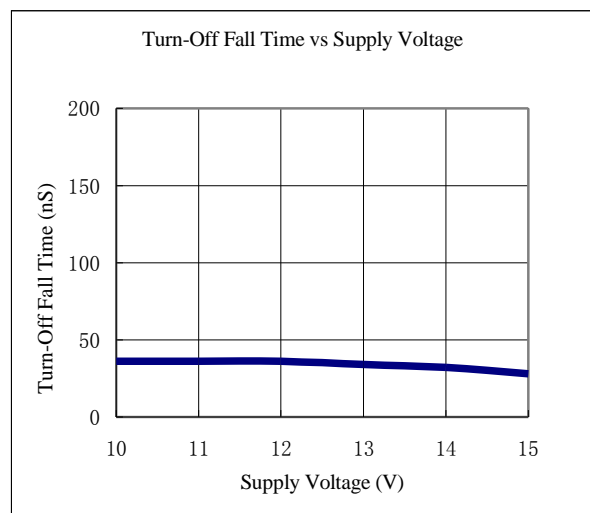
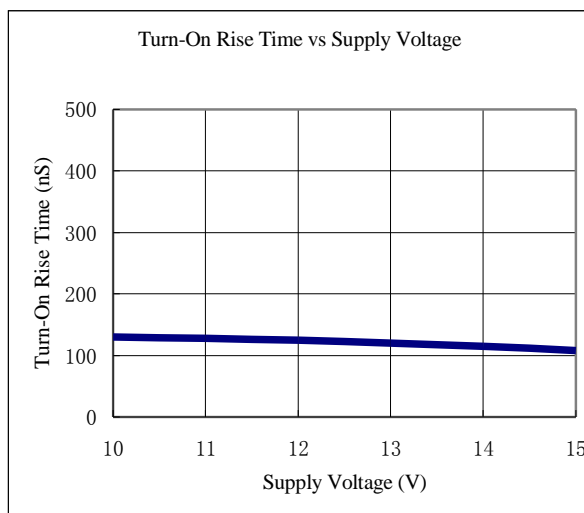
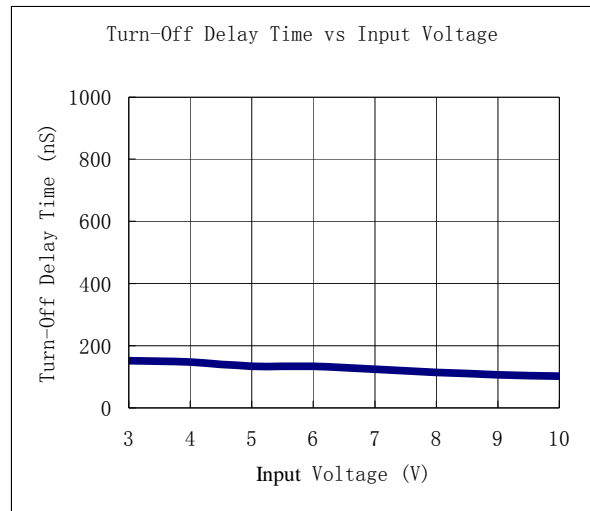
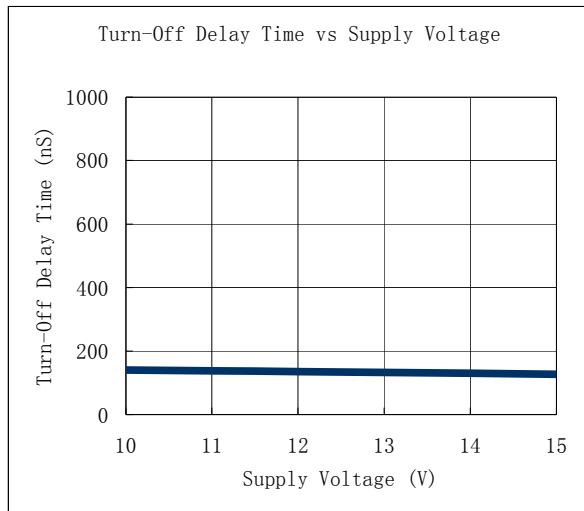
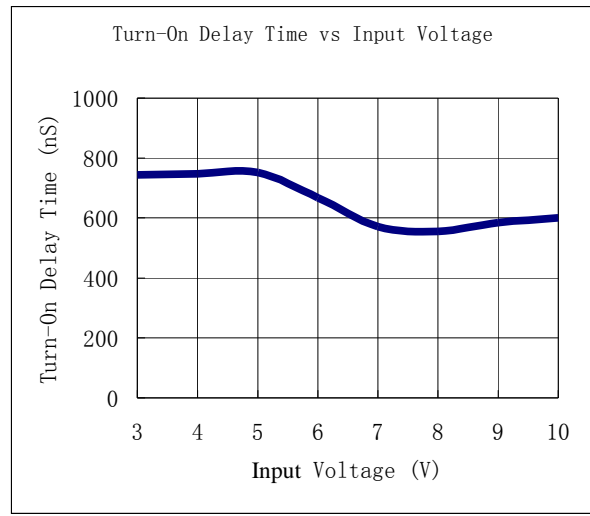
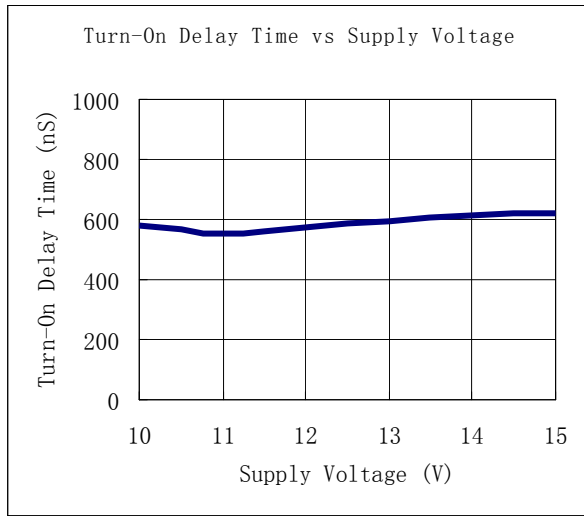
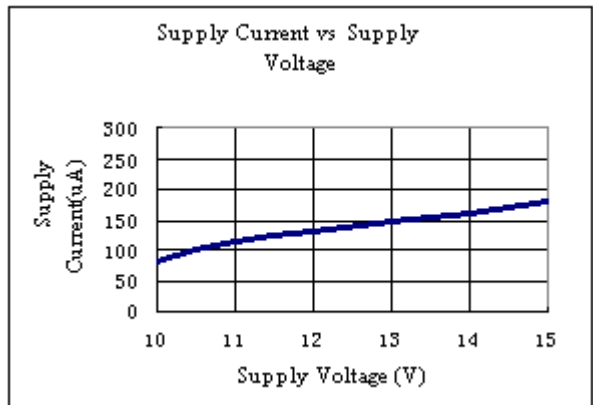
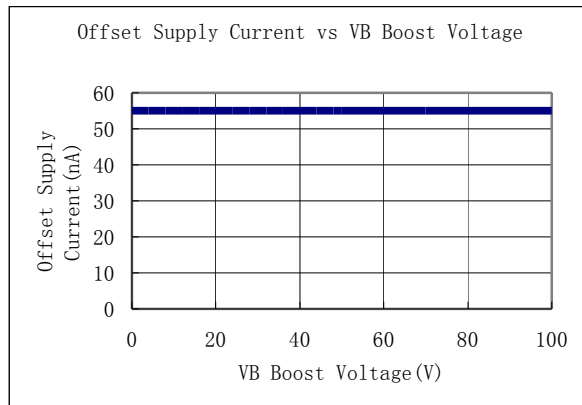
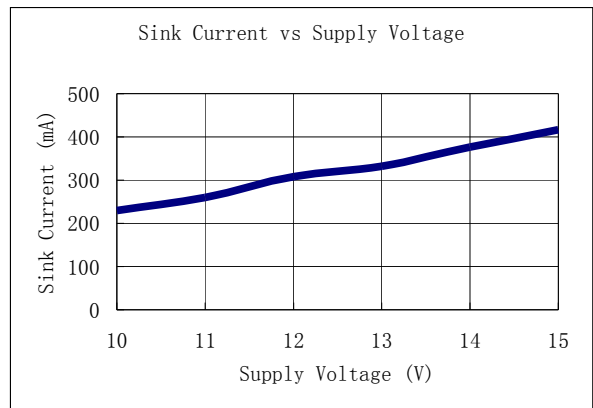
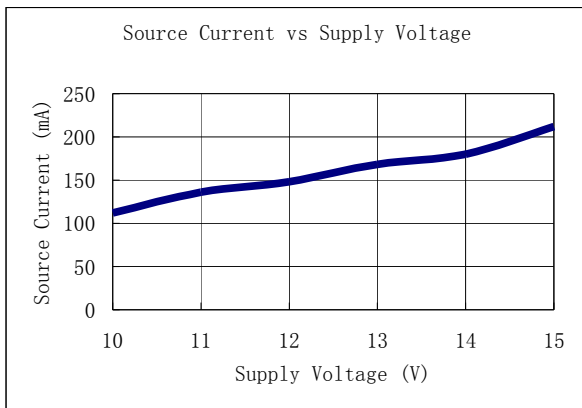
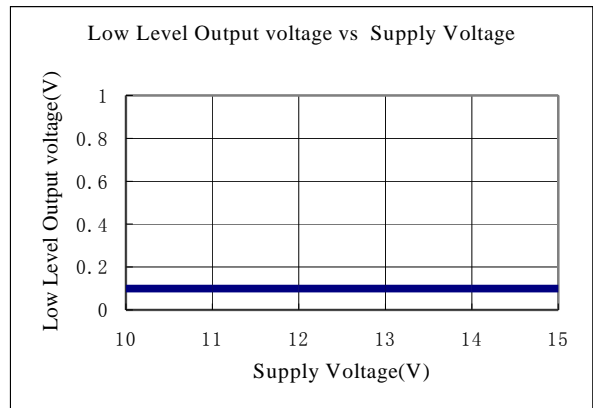
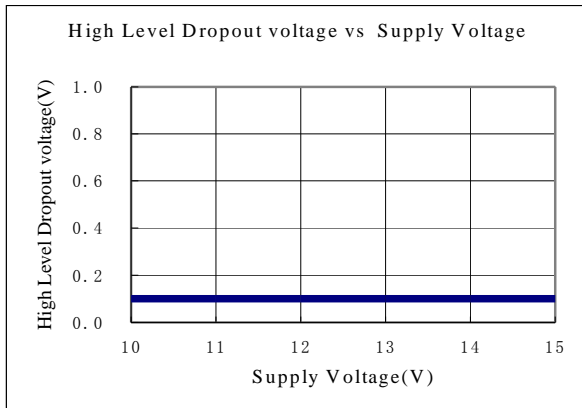
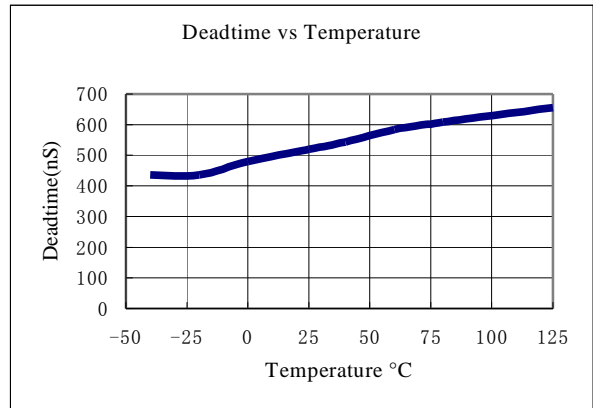
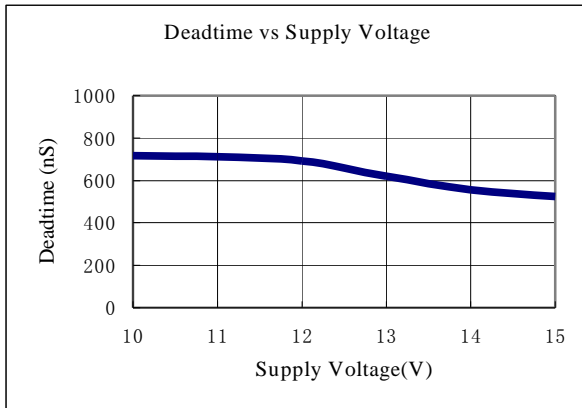

Figure 3: Dead Time Definition

Typical Characteristics



Typical Characteristics (Continued)

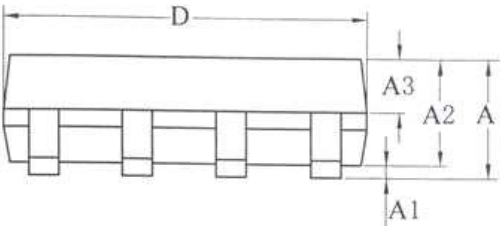

Packaging Information

Package	SOIC-8	Devices per reel	2500Pcs	Unit	mm																																																																			
Package specification:																																																																								
		<table border="1"> <thead> <tr> <th rowspan="2">SYMBOL</th> <th colspan="3">MILLIMETER</th> </tr> <tr> <th>MIN</th> <th>NOM</th> <th>MAX</th> </tr> </thead> <tbody> <tr> <td>A</td> <td>—</td> <td>—</td> <td>1.77</td> </tr> <tr> <td>A1</td> <td>0.08</td> <td>0.18</td> <td>0.28</td> </tr> <tr> <td>A2</td> <td>1.20</td> <td>1.40</td> <td>1.60</td> </tr> <tr> <td>A3</td> <td>0.55</td> <td>0.65</td> <td>0.75</td> </tr> <tr> <td>b</td> <td>0.39</td> <td>—</td> <td>0.48</td> </tr> <tr> <td>b1</td> <td>0.38</td> <td>0.41</td> <td>0.43</td> </tr> <tr> <td>c</td> <td>0.21</td> <td>—</td> <td>0.26</td> </tr> <tr> <td>c1</td> <td>0.19</td> <td>0.20</td> <td>0.21</td> </tr> <tr> <td>D</td> <td>4.70</td> <td>4.90</td> <td>5.10</td> </tr> <tr> <td>E</td> <td>5.80</td> <td>6.00</td> <td>6.20</td> </tr> <tr> <td>E1</td> <td>3.70</td> <td>3.90</td> <td>4.10</td> </tr> <tr> <td>e</td> <td colspan="3">1.27BSC</td> </tr> <tr> <td>L</td> <td>0.50</td> <td>0.65</td> <td>0.80</td> </tr> <tr> <td>L1</td> <td colspan="3">1.05BSC</td> </tr> <tr> <td>θ</td> <td>0</td> <td>—</td> <td>8°</td> </tr> </tbody> </table>				SYMBOL	MILLIMETER			MIN	NOM	MAX	A	—	—	1.77	A1	0.08	0.18	0.28	A2	1.20	1.40	1.60	A3	0.55	0.65	0.75	b	0.39	—	0.48	b1	0.38	0.41	0.43	c	0.21	—	0.26	c1	0.19	0.20	0.21	D	4.70	4.90	5.10	E	5.80	6.00	6.20	E1	3.70	3.90	4.10	e	1.27BSC			L	0.50	0.65	0.80	L1	1.05BSC			θ	0	—	8°
SYMBOL	MILLIMETER																																																																							
	MIN	NOM	MAX																																																																					
A	—	—	1.77																																																																					
A1	0.08	0.18	0.28																																																																					
A2	1.20	1.40	1.60																																																																					
A3	0.55	0.65	0.75																																																																					
b	0.39	—	0.48																																																																					
b1	0.38	0.41	0.43																																																																					
c	0.21	—	0.26																																																																					
c1	0.19	0.20	0.21																																																																					
D	4.70	4.90	5.10																																																																					
E	5.80	6.00	6.20																																																																					
E1	3.70	3.90	4.10																																																																					
e	1.27BSC																																																																							
L	0.50	0.65	0.80																																																																					
L1	1.05BSC																																																																							
θ	0	—	8°																																																																					
