



LC573202A

4-Bit Microcontroller with 2K-Byte ROM, 64 × 4Bits RAM and LCD Driver

Preliminary

Overview

The LC573202A is a CMOS 4-bit microcontroller that operates on low voltage and very low power consumption. It also contains 2K-byte ROM, 64 × 4 bits RAM, LCD drivers and melody function.

Features

(1) Read-Only Memory (ROM)

- 2048 × 8 bits

(2) Random Access Memory (RAM)

- 64 × 4 bits

(3) Cycle Time

Cycle time	Oscillation source	Oscillation Frequency	Power supply voltage	Power source
122μs	Crystal oscillation	32.768kHz	1.30 - 1.65V	Ag Battery
	RC oscillation			
122μs	Crystal oscillation	32.768kHz	2.60 - 3.60V	Li Battery
122μs	Crystal oscillation	32.768kHz	2.00 - 6.00V	External voltage supply
	RC oscillation			

(4) Input/Output ports

- Input ports : 6 ports (S-port : 4 terminals, M-port : 2 terminals)
- Output ports : 1 port (Buzzer output/General output port : mask option changeover)
- LCD segment output ports : 25 terminals
(Possible to use output port (SEG13 to SEG25) : by mask option)
- LCD common output ports : 4 terminals

■ Any and all SANYO products described or contained herein do not have specifications that can handle applications that require extremely high levels of reliability, such as life-support systems, aircraft's control systems, or other applications whose failure can be reasonably expected to result in serious physical and/or material damage. Consult with your SANYO representative nearest you before using any SANYO products described or contained herein in such applications.

■ SANYO assumes no responsibility for equipment failures that result from using products at values that exceed, even momentarily, rated values (such as maximum ratings, operating condition ranges, or other parameters) listed in products specifications of any and all SANYO products described or contained herein.

Pad assignment

Chip thickness : 480μm
 Chip size (X × Y) : 2.54mm × 2.27mm
 Pad size : 120μm × 120μm
 Pad pitch : 140μm minimum

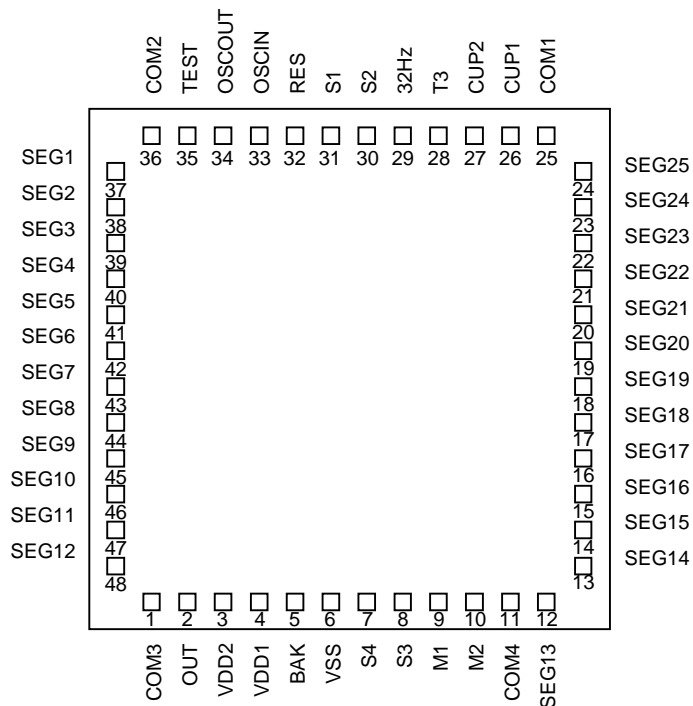

Note:

When a Lithium battery has been selected as the power supply, please note the following points.
 There are two modes of use for the lithium battery: Backup mode and Normal mode (backup flag off). In backup mode, the battery potential is applied directly to the oscillation circuit, whereas in Normal mode only half the battery potential is applied.
 Because of the different voltage applied to the oscillation circuit in each mode, there may be a difference in the generated oscillation frequency. When entering backup mode a corresponding error will arise. If timing accuracy is required (for clocks, etc), please bear in mind the above in the program design.

Pad name and coordinates

QFP64 PIN No.	Pad No.	Pad Name	Coordinates	
			X μ m	Y μ m
1	1	COM3	-700	-1030
2	2	OUT	-560	-1030
3	3	VDD2	-420	-1030
4	4	VDD1	-275	-1030
5	5	BAK	-135	-1030
6	6	VSS	5	-1030
7	7	S4	145	-1030
8	8	S3	285	-1030
9	9	M1	425	-1030
10	10	M2	565	-1030
11	11	COM4	705	-1030
12	12	SEG13	845	-1030
13	13	SEG14	895	-775
14	14	SEG15	895	-635
15	15	SEG16	895	-495
16	16	SEG17	895	-355
17	17	SEG18	895	-215
18	18	SEG19	895	-75
19	19	SEG20	895	65
20	20	SEG21	895	205
21	21	SEG22	895	345
22	22	SEG23	895	485
23	23	SEG24	895	625
24	24	SEG25	895	765

QFP64 PIN No.	Pad No.	Pad Name	Coordinates	
			X μ m	Y μ m
25	25	COM1	840	1030
26	26	CUP1	700	1030
27	27	CUP2	560	1030
28	28	T3	420	1030
29	29	32HZ	280	1030
30	30	S2	140	1030
31	31	S1	0	1030
32	32	RES	-140	1030
33	33	OSCIN	-280	1030
34	34	OSCOU	-420	1030
35	35	TEST	-560	1030
36	36	COM2	-700	1030
37	37	SEG1	-895	765
38	38	SEG2	-895	625
39	39	SEG3	-895	485
40	40	SEG4	-895	345
41	41	SEG5	-895	205
42	42	SEG6	-895	65
43	43	SEG7	-895	-75
44	44	SEG8	-895	-215
45	45	SEG9	-895	-355
46	46	SEG10	-895	-495
47	47	SEG11	-895	-635
48	48	SEG12	-895	-775

- The pad coordinates are such that the chip center is taken as the origin and the values for (X, Y) represent the coordinates of the center point of each pad.
- Substrate must be connected to VSS or left open.

System Block Diagram

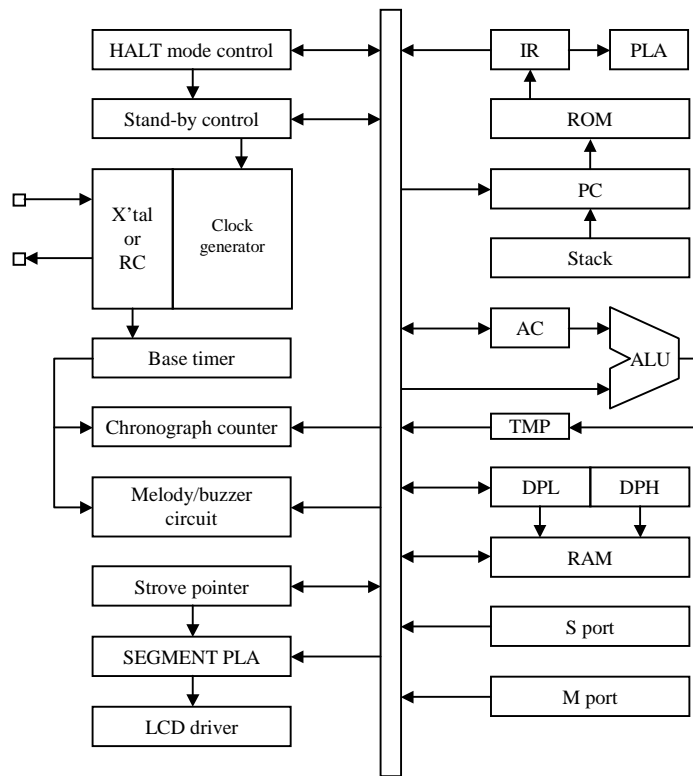

LC573202A Terminal Description

Pin Name	Pad No. Pin No.	I/O	Function description	Option
VSS	6	-	Power terminal(-)	-
VDD1	4	-	<ul style="list-style-type: none"> •Power terminal(+) (Ag battery version) •Voltage supply to LCD driver (Li battery & EXTV ver.) (C is connected between VDD1 and VSS.) •Voltage supply to logic unit (Ag battery version, Back up flag OFF at Li battery version.) 	Battery version Ag/Li/EXTV
VDD2	3	-	<ul style="list-style-type: none"> •Power terminal(+) (Li battery & EXTV version) •Voltage supply to LCD driver (Ag battery version) (C is connected between VDD2 and VSS.) •Voltage supply to logic unit (EXTV version, Back up flag ON at Li battery version.) 	Battery version Ag/Li/EXTV
BAK	5	-	<ul style="list-style-type: none"> •Power terminal(+) •For Li battery version, a capacitor must be connected across BAK and VSS to prevent logic unit from malfunctioning. 	-
CUP1, 2	26, 27	-	Capacitor connecting terminals for step-up/step-down.	-
S PORT S1 to S4	31 30 8 7	I	<ul style="list-style-type: none"> •4-bit input port •Input for HALT release •LSI system is reset by applying VDD* to S1 to S4 simultaneously. (Mask option) <div style="text-align: center;"> [*Ag version : VDD1 Li/EXTV version] : </div> <p>VDD2</p> <ul style="list-style-type: none"> •Programmable pull-down resistor •"L"-level hold Tr. (Mask option) 	<ul style="list-style-type: none"> •"L"-level hold Tr. Provided/Not provided •Reset by setting S1-S4 Enable/disable
M-PORT M1, M2	9 10	I	<ul style="list-style-type: none"> •2-bit input port •Input for HALT release •Programmable pull-down resistor •"L"-level hold Tr. 	•"L"-level hold Tr. Provided/Not provided
OUT	2	O	<ul style="list-style-type: none"> •Output terminal •Selectable general output or buzzer output by mask option (1) As using general output port •The output level is controlled by executing the SLGT and RLGT instructions. (2) As using buzzer output •Melody signal or 9 kinds of modulated signal is controlled by executing the SAS or TMEL instructions.* (Possible to output non-modulated signal) •Possible to output 3 octave melody signal. 	•Output data Melody(Buzzer) /General output
SEG1 to SEG25	37 to 48 12 to 24	O	<ul style="list-style-type: none"> •LCD output terminals for segment •Possible to use output port for SEG13 to SEG25 (Pad No.12 to 24) by mask option. •SEG13 can be used as COM4 output by mask option. 	<ul style="list-style-type: none"> •Output form segment/CMOS (SEG13-SEG25) •Output data SP=0-FH, DBUS=a/b/c/d/e/f/g/h •SEG13/COM4
COM1 to COM4	25, 36 1, 11	O	<ul style="list-style-type: none"> •LCD output terminals for common •COM4 can be used as normal output terminal by mask option. 	<ul style="list-style-type: none"> •LCD duty 1/1,1/2,1/3,1/4 •COM4/LIGHT

Continue.

Pin Name	Pad No. Pin No.	I/O	Function description	Option
OSCIN	33	I	<ul style="list-style-type: none"> •Input for 32.768kHz crystal oscillation •Input for RC oscillation •R is connected between OSCIN and OSCOUT and C is connected between OSCIN and VSS. 	<ul style="list-style-type: none"> •Oscillation circuit X'tal oscillation /external RC oscillation
OSCOUT	34	O	<ul style="list-style-type: none"> •Output for 32.768kHz crystal oscillation •Output for RC oscillation •R is connected between OSCIN and OSCOUT. 	<ul style="list-style-type: none"> •Oscillation circuit X'tal oscillation /external RC oscillation
RES	32	I	Reset	
TEST	35	-	<ul style="list-style-type: none"> •Test terminal •This terminal should be left unconnected. 	
T3	28	-	<ul style="list-style-type: none"> •Test terminal •This terminal should be left unconnected. 	
32Hz	29	-	<ul style="list-style-type: none"> •Test terminal •This terminal should be left unconnected. 	

* 9 kinds of modulated output : For 32.768kHz crystal oscillation, proportional to oscillation frequency.
Please refer to User's manual for more detail.

(Note) There are two operation modes, back-up mode (back up flag on) and normal mode (back up flag off), in Li battery specification. In normal operation mode, the internal circuit of CPU is operated on 1/2 of Li battery voltage (it can be monitored as external capacitor voltage of voltage step down circuit).
The power consumption can be saved in normal mode operation. However, the large current flown into/from the buzzer output or output port will generate a voltage drop-down and it might be a cause of abnormal CPU operation. If the microcontroller has to drive a large current, switch the CPU into the back up mode before driving the current. CPU consumes the relatively large current in back up mode. When the Li battery voltage has recovered, you should change the CPU into the normal mode.
CPU is in the back up mode at reset.

Sample Application Circuit

(1) Ag battery used application
(1/2 bias 1/4 duty)

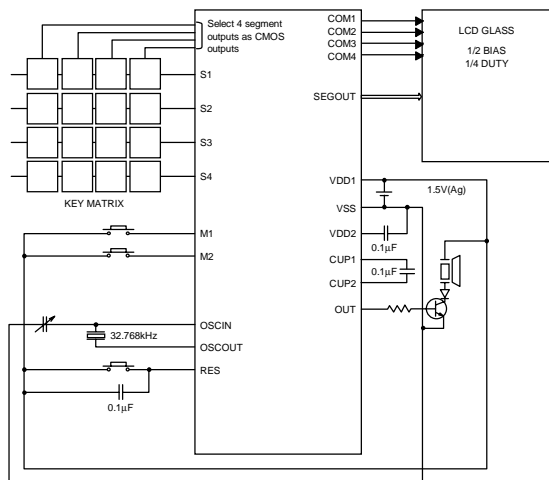

Crystal Oscillation
(Power supply : Ag battery version)

(2) Li battery used application
(1/2 bias 1/3 duty)

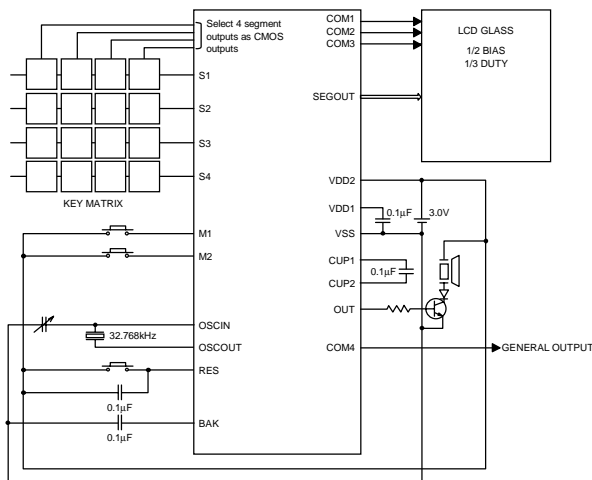

Crystal Oscillation
(Power supply : Li battery version)
note) COM4 is used as normal output by mask option.

(3) EXT-V used application
(1/2 bias 1/4 duty)

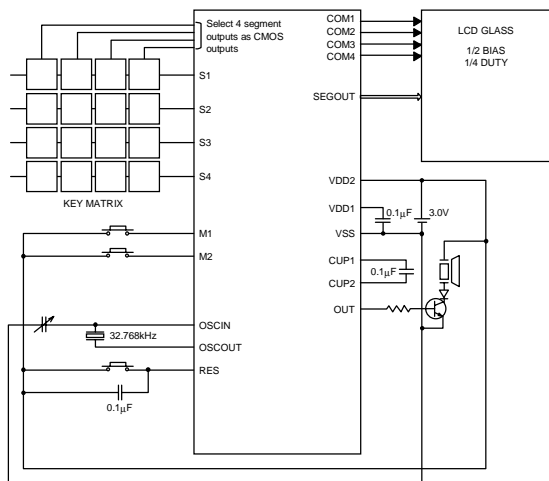

Crystal Oscillation
(Power supply : EXT-V version)

(Note) If LCD driver terminals (SEG13 - 25) are used for key scan output port, diodes or resistors must be added to prohibit signal short between output ports when two or more keys are pushed simultaneously.

Ag battery version

1. Absolute Maximum Ratings at Ta=25±2°C, VSS=0V

Parameter	Symbol	Pin & Conditions	Ratings	Unit
Supply voltage	VDD1		-0.3 to +4.0	V
	VDD2		-0.3 to +4.0	
Input voltage	VIN	S1-S4, M1, M2, TEST, OSCIN, RES	-0.3 to VDD1+0.3	
Output voltage	VOUT1	CUP2, OSCOUT, OUT	-0.3 to VDD1+0.3	
	VOUT2	SEG1-SEG25, COM1-COM4, CUP1	-0.3 to VDD2+0.3	
Peak output current (at each pins)	IOUT1	OUT	4	mA
	IOUT2	COM4 (As using LIGHT)	1	
	IOUT3	Output except OUT and COM4	500	µA
Total output current	IALL	Total output pins.	10	mA
Maximum power dissipation	Pdmax	QFP48	430	mW
Operating temperature range	Topr		-30 to +70	°C
Storage temperature range	Tstg		-40 to +125	

2. Recommended Operating Range at Ta=-30°C to + 70°C, VSS=0V

Parameter	Symbol	Conditions	Ratings			Unit
			min.	typ.	max.	
Operating supply voltage	VDD1		1.30		1.65	V
	VDD2		2.4		3.3	
Input high voltage	VIH	S1-S4, RES, M1, M2	VDD1-0.2		VDD1	
Input low voltage	VIL	S1-S4, RES, M1, M2	0		0.2	
Oscillation frequency range	fOPG1	•32.768kHz (crystal oscillation) •VDD1=1.30 - 1.65V •Refer to figure 1	32	32.768	33	kHz
	fOPG2	•RC oscillation •VDD1=1.30 - 1.65V •Refer to figure 2	30		40	

[Note]

These specified value herein are based on the QIP48E packaged parts. The specification for the die is basically the same as the one for package part. However, it will be affected by the many factors such as the mounting board, bonding pressure, cover up epoxy etc.

Therefore the value specified here are only applied in Ta=25°C±2°C operating temperature range.

3. Electrical Characteristics at Ta=-30°C to +70°C, VSS=0V

Parameter	Symbol	Conditions	Ratings			Unit
			min.	typ.	max.	
Pull-down transistor	RIN1A	VDD1=1.55V, VIL=0.2V, Low level hold Tr. Fig.3 *1	150	300	1000	kΩ
	RIN1B	VDD1=1.55V, Low level pull in Tr. Fig.3 *1	100	300	1000	
	RIN2	VDD1=1.55V, TEST, RES	10		300	
Output high voltage	VOH1	VDD1=1.55V, IOH=-0.4μA *2	VDD2-0.2			V
Output low voltage	VOL1	VDD1=1.55V, IOL=0.4μA *2			0.2	
Output high voltage	VOH2	VDD1=1.55V, IOH=-4μA, COM1-4	VDD2-0.2			
Output middle voltage	VOM	VDD1=1.55V, IOH=-4μA, IOL=4μA, COM1-4	VDD1-0.2		VDD1+0.2	
Output low voltage	VOL2	VDD1=1.55V, IOL=4μA, COM1-4			0.2	
Output high voltage	VOH3	VDD1=1.35V, IOH=-250μA, OUT, COM4 (As using LIGHT)	VDD1-0.65			
Output low voltage	VOL3	VDD1=1.35V, IOL=150μA, OUT, COM4 (As using LIGHT)			0.65	
Output high voltage	VOH4	VDD1=1.55V, IOH=-20μA *3	VDD1-0.2			
Output low voltage	VOL4	VDD1=1.55V, IOL=20μA *3			0.2	
Step-up voltage	VDD2	VDD1=1.35V, C1=C2=0.1μF, f _{opg} =32.768kHz, Fig.4	2.5		2.7	
Current dissipation (In Halt mode)	IDD1	VDD1=1.55V, C1=C2=0.1μF, Fig.4, C _g =16pF, Crystal osc (CI≤25kΩ), Back-up flag OFF, Ta≤50°C		1.0	4.0	μA
	IDD2	VDD1=1.55V, C1=C2=0.1μF, Fig.5, RC osc (R _{ext} =470kΩ, C _{ext} =30pF), Ta≤50°C		5.0	15.0	
Current dissipation (In Operating mode)	IDD3	VDD1=1.55V, C1=C2=0.1μF, Fig.4, C _g =16pF, Crystal osc (CI≤25kΩ), Back-up flag OFF, Ta≤50°C		3.0	12.0	μA
	IDD4	VDD1=1.55V, C1=C2=0.1μF, Fig.5, RC osc (R _{ext} =470kΩ, C _{ext} =30pF), Ta≤50°C		7.0	20.0	
Oscillator start-up voltage	V _{stt}	C _g =16pF, Crystal osc (CI≤25kΩ), Back-up flag ON, Ta=25°C, Fig.6	1.30			V
Oscillator sustaining voltage	V _{HOLD}	C _g =16pF, Crystal osc (CI≤25kΩ), Back-up flag OFF, Ta=25°C, Fig.6	1.30			
Oscillator start-up time	t _{stt}	VDD1=1.35V C _g =16pF, Crystal osc (CI≤25kΩ), Back-up flag ON, Ta=25°C, Fig.6			10	s

Li battery version

1. Absolute Maximum Ratings at Ta=25±2°C, VSS=0V

Parameter	Symbol	Pin & Conditions	Ratings	Unit
Supply voltage	VDD1		-0.3 to +4.0	V
	VDD2		-0.3 to +4.0	
Input voltage	VIN1	OSCIN (Back-up flag OFF)	-0.3 to VDD1+0.3	
	VIN2	S1-S4, M1, M2, TEST, RES OSCIN (Back-up flag ON)	-0.3 to VDD2+0.3	
Output voltage	VOUT1	CUP2, OSCOUT (Back-up flag OFF)	-0.3 to VDD1+0.3	
	VOUT2	SEG1-SEG25, COM1-COM4, CUP1, OUT, OSCOUT (Back-up flag ON)	-0.3 to VDD2+0.3	
Peak output current (at each pins)	IOUT1	OUT	4	mA
	IOUT2	COM4 (As using LIGHT)	1	
	IOUT3	Output except OUT and COM4	500	µA
Total output current	IALL	The total all pins.	10	mA
Maximum power dissipation	Pdmax	QFP48	430	mW
Operating temperature range	Topr		-30 to +70	°C
Storage temperature range	Tstg		-40 to +125	

2. Recommended Operating Range at Ta=-30°C to +70°C, VSS=0V

Parameter	Symbol	Conditions	Ratings			Unit
			min.	typ.	max.	
Operating supply voltage	VDD1		1.30		3.6	V
	VDD2		2.6		3.6	
Input high voltage	VIH	S1-S4, RES, M1, M2	VDD2-0.4		VDD2	
Input low voltage	VIL	S1-S4, RES, M1, M2	0		0.4	
Oscillation frequency range	fOPG1	•32.768kHz (crystal oscillation) •VDD2=2.6 - 3.6V •Refer to figure 1	32	32.768	33	kHz

LC573202A

3. Electrical Characteristics at Ta=-30°C to +70°C, VSS=0V

Parameter	Symbol	Conditions	Ratings			Unit	
			min.	typ.	max.		
Pull-down transistor	RIN1A	VDD2=2.9V, VIL=0.4V, Low level hold Tr. Fig.3 *1	150	300	1000	kΩ	
	RIN1B	VDD2=2.9V, Low level pull in Tr. Fig.3 *1	100	300	1000		
	RIN2	VDD2=2.9V, TEST, RES	10		300		
Output high voltage	VOH1	VDD2=2.9V, IOH=-0.4μA *2	VDD2-0.2			V	
Output low voltage	VOL1	VDD2=2.9V, IOL=0.4μA *2			0.2		
Output high voltage	VOH2	VDD2=2.9V, IOH=-4μA, COM1-4	VDD2-0.2				
Output middle voltage	VOM	VDD2=2.9V, IOH=-4μA, IOL=4μA, COM1-4	VDD2/2 -0.2		VDD2/2 +0.2		
Output low voltage	VOL2	VDD2=2.9V, IOL=4μA, COM1-4			0.2		
Output high voltage	VOH3	VDD2=2.4V, IOH=-250μA, OUT	VDD2-0.65				
Output low voltage	VOL3	VDD2=2.4V, IOL=250μA, OUT			0.65		
Output high voltage	VOH4	VDD2=2.4V, IOH=-150μA, COM4 (As using LIGHT)	VDD2-1.5				
Output low voltage	VOL4	VDD2=2.4V, IOL=150μA, COM4 (As using LIGHT)			1.5		
Output high voltage	VOH5	VDD2=2.9V, IOH=-40μA *3	VDD2-0.4				
Output low voltage	VOL5	VDD2=2.9V, IOL=40μA *3			0.4		
Step-down voltage	VDD1	VDD2=2.8V, C1=C2=0.1μF, fopg=32.768kHz, Fig.7	1.35				V
Current dissipation (In Halt mode)	IDD1	VDD2=2.9V, C1=C2=0.1μF, Fig.7, Cg=16pF, Crystal osc (CI≤25kΩ), Back-up flag OFF, Ta≤50°C		0.8	2.0		μA
Current dissipation (In Operating mode)	IDD2	VDD2=2.9V, C1=C2=0.1μF, Fig.7, Cg=16pF, Crystal osc (CI≤25kΩ), Back-up flag OFF, Ta≤50°C		1.5	5.0		
Oscillator start-up voltage	Vstt	Cg=16pF, Crystal osc (CI≤25kΩ), Back-up flag ON, Ta=25°C, Fig.9	2.60			V	
Oscillator sustaining voltage	VHOLD	Cg=16pF, Crystal osc (CI≤25kΩ), Back-up flag OFF, Ta=25°C, Fig.9	2.60				
Oscillator start-up time	tsst	VDD2=2.60V Cg=16pF, Crystal osc (CI≤25kΩ), Back-up flag ON, Ta=25°C, Fig.9			10	s	

EXT-V version**1. Absolute Maximum Ratings at Ta=25±2°C, VSS=0V**

Parameter	Symbol	Pin & Conditions	Ratings	Unit
Supply voltage	VDD1		-0.3 to +7.0	V
	VDD2		-0.3 to +7.0	
Input voltage	VIN	S1-S4, M1, M2, TEST, OSCIN, RES	-0.3 to VDD2+0.3	
Output voltage	VOUT	SEG1-SEG25, COM1-COM4, CUP1, CUP2, OSCOUT, OUT	-0.3 to VDD2+0.3	
Peak output current (at each pins)	IOUT1	OUT	4	mA
	IOUT2	COM4 (As using LIGHT)	1	
	IOUT3	Output except OUT and COM4	500	µA
Total output current	IALL	The total all pins.	10	mA
Maximum power dissipation	Pdmax	QFP48	430	mW
Operating temperature range	Topr		-30 to +70	°C
Storage temperature range	Tstg		-40 to +125	

2. Recommended Operating Range at Ta=-30°C to + 70°C, VSS=0V

Parameter	Symbol	Conditions	Ratings			Unit
			min.	typ.	max.	
Operating supply voltage	VDD1		1.3		3.0	V
	VDD2		2.0		6.0	
Input high voltage	VIH	S1-S4, RES, M1, M2	VDD2-0.4		VDD2	
Input low voltage	VIL	S1-S4, RES, M1, M2	0		0.4	
Oscillation frequency range	fOPG1	•32.768kHz (crystal oscillation) •VDD2=2.0 - 6.0V •Refer to figure 1	32	32.768	33	kHz
	fOPG2	•RC oscillation •VDD2=2.0 - 6.0V •Refer to figure 2	30		40	

LC573202A

3. Electrical Characteristics at Ta=-30°C to +70°C, VSS=0V

Parameter	Symbol	Conditions	Ratings			Unit
			min.	typ.	max.	
Pull-down transistor	RIN1A	VDD2=2.9V, VIL=0.4V, Low level hold Tr. Fig.3 *1	150	300	1000	kΩ
	RIN1B	VDD2=2.9V, Low level pull in Tr. Fig.3 *1	100	300	1000	
	RIN2	VDD2=2.9V, TEST, RES	10		300	
Output high voltage	VOH1	VDD2=2.9V, IOH=-0.4μA *2	VDD2-0.2			V
Output low voltage	VOL1	VDD2=2.9V, IOL=0.4μA *2			0.2	
Output high voltage	VOH2	VDD2=2.9V, IOH=-4μA, COM1-4	VDD2-0.2			
Output middle voltage	VOM	VDD2=2.9V, IOH=-4μA, IOL=4μA, COM1-4	VDD2/2 -0.2		VDD2/2 +0.2	
Output low voltage	VOL2	VDD2=2.9V, IOL=4μA, COM1-4			0.2	
Output high voltage	VOH3	VDD2=2.4V, IOH=-250μA, OUT	VDD2-0.65			
Output low voltage	VOL3	VDD2=2.4V, IOL=250μA, OUT			0.65	
Output high voltage	VOH4	VDD2=2.4V, IOH=-150μA, COM4 (As using LIGHT)	VDD2-1.5			
Output low voltage	VOL4	VDD2=2.4V, IOL=150μA, COM4 (As using LIGHT)			1.5	
Output high voltage	VOH5	VDD2=2.9V, IOH=-40μA *3	VDD2-0.4			
Output low voltage	VOL5	VDD2=2.9V, IOL=40μA *3			0.4	
Step-down voltage	VDD1	VDD2=2.8V, C1=C2=0.1μF, fopg=32.768kHz, Fig.7	1.35			
Current dissipation (In Halt mode)	IDD1	VDD2=2.9V, C1=C2=0.1μF, Fig.7, Cg=15pF, Crystal osc (CI≤25kΩ), Ta≤50°C		3.0	15.0	μA
	IDD2	VDD2=2.9V, C1=C2=0.1μF, Fig.8, RC osc (Rext=470kΩ, Cext=30pF), Ta≤50°C		40	150	
Current dissipation	IDD3	VDD2=2.9V, C1=C2=0.1μF, Fig.7, Cg=15pF, Crystal osc (CI≤25kΩ), Ta≤50°C		7.0	30.0	
	IDD4	VDD2=2.9V, C1=C2=0.1μF, Fig.8, RC osc (Rext=470kΩ, Cext=30pF), Ta≤50°C		50	180	
Oscillator start-up voltage	Vstt	Cg=15pF, Crystal osc (CI≤25kΩ), Ta=25°C, Fig.9	2.0			V
Oscillator sustaining voltage	VHOLD	Cg=15pF, Crystal osc (CI≤25kΩ), Ta=25°C, Fig.9	2.0			
Oscillator start-up time	tstt	VDD2=2.0V Cg=15pF, Crystal osc (CI≤25kΩ), Ta=25°C, Fig.9			10	s

LC573202A

Electrical Characteristics at Ta=-30°C to + 70°C, VSS=0V

Parameter	Symbol	Conditions	Ratings			Unit	
			min.	typ.	max.		
Pull-down transistor	RIN1A	VDD2=5.0V, VIL=0.4V, Low level hold Tr. Fig.3 *1	70	200	600	kΩ	
	RIN1B	VDD2=5.0V, Low level pull in Tr. Fig.3 *1	50	150	500		
	RIN2	VDD2=5.0V, TEST, RES	10		300		
Output high voltage	VOH1	VDD2=5.0V, IOH=-0.4μA *2	VDD2-0.2			V	
Output low voltage	VOL1	VDD2=5.0V, IOL=0.4μA *2			0.2		
Output high voltage	VOH2	VDD2=5.0V, IOH=-4μA, COM1-4	VDD2-0.2				
Output middle voltage	VOM	VDD2=5.0V, IOH=-4μA, IOL=4μA, COM1-4	VDD2/2 -0.2		VDD2/2 +0.2		
Output low voltage	VOL2	VDD2=5.0V, IOL=4μA, COM1-4			0.2		
Output high voltage	VOH3	VDD2=5.0V, IOH=-2.0mA, OUT	VDD2-1.0				
Output low voltage	VOL3	VDD2=5.0V, IOL=2.0mA, OUT			1.0		
Output high voltage	VOH4	VDD2=5.0V, IOH=-250μA, COM4 (As using LIGHT)	VDD2-1.5				
Output low voltage	VOL4	VDD2=5.0V, IOL=250μA, COM4 (As using LIGHT)			1.5		
Output high voltage	VOH5	VDD2=5.0V, IOH=-80μA *3	VDD2-0.8				
Output low voltage	VOL5	VDD2=5.0V, IOL=80μA *3			0.8		
Step-down voltage	VDD1	VDD2=5.0V, C1=C2=0.1μF, f _{opg} =32.768kHz, Fig.7	2.4				V
Current dissipation (In Halt mode)	IDD1	VDD2=5.0V, C1=C2=0.1μF, Fig.7, C _g =15pF, Crystal osc (C _I ≤25kΩ, T _a ≤50°C		8.0	20.0		μA
	IDD2	VDD2=5.0V, C1=C2=0.1μF, Fig.8, RC osc (R _{ext} =470kΩ, C _{ext} =30pF), T _a ≤50°C		230	500		
Current dissipation (In Operating mode)	IDD3	VDD2=5.0V, C1=C2=0.1μF, Fig.7, C _g =15pF, Crystal osc (C _I ≤25kΩ), T _a ≤50°C		30	50	μA	
	IDD4	VDD2=5.0V, C1=C2=0.1μF, Fig.8, RC osc (R _{ext} =470kΩ, C _{ext} =30pF), T _a ≤50°C		250	500		
Oscillator start-up voltage	V _{stt}	C _g =15pF, Crystal osc (C _I ≤25kΩ), T _a =25°C, Fig.9	2.0			V	
Oscillator sustaining voltage	V _{HOLD}	C _g =15pF, Crystal osc (C _I ≤25kΩ), T _a =25°C, Fig.9	2.0				
Oscillator start-up time	t _{stt}	VDD2=2.0V, C _g =15pF, Crystal osc (C _I ≤25kΩ), T _a =25°C, Fig.9			10	s	

*1 : S1, S2, S3, S4, M1, M2

*2 : SEG1 to SEG12 and LCD output pins out of SEG13 to SEG25.

*3 : OUTPUT PORT pins out of SEG13 to SEG25.

Crystal oscillation guaranteed constant

Oscillation type	Maker	Oscillator	C _g
32.768kHz Crystal oscillation	CITIZEN	CFS-308	
	SHI	DT-VT-200	

* Both C_g and C_d must be a J rank (±5%) and CH characteristics.

- (Notes)
- Since the circuit pattern affects the oscillation frequency, place the oscillation-related parts as close to the oscillation pins as possible with the shortest possible pattern length.
 - If you use other oscillators herein, we provide no guarantee for the characteristics.

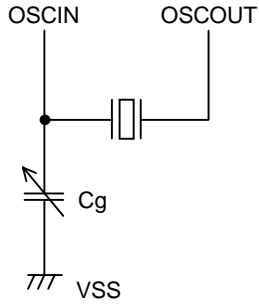

Figure 1 Crystal oscillation circuit

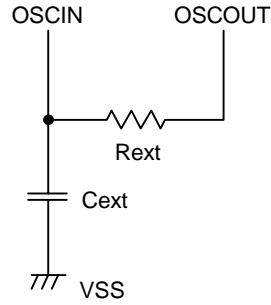

Figure 2 RC oscillation circuit

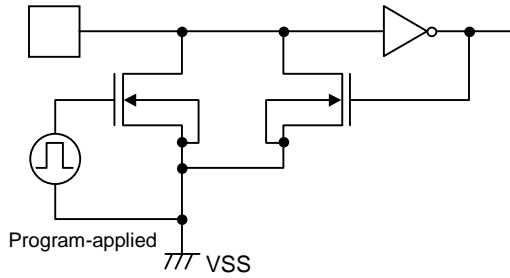

Figure 3 Input configuration of S1-4, M1, M2

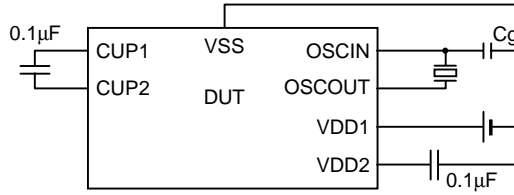

Figure 4 Current dissipation, step-up voltage measurement

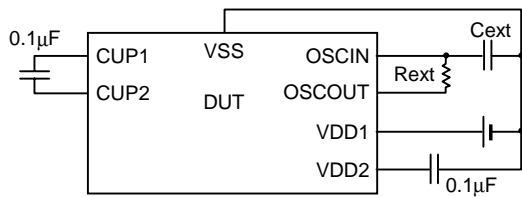

Figure 5 Current dissipation, step-up voltage measurement

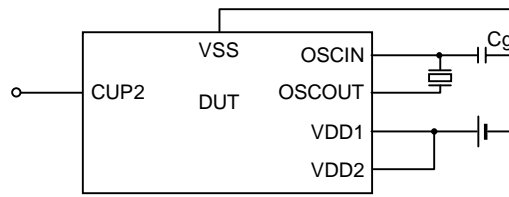

Figure 6 Oscillator start-up voltage, oscillator start-up time, oscillator sustaining voltage measurement

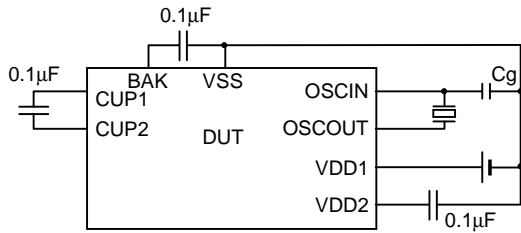

Figure7 Current dissipation, step-down voltage measurement

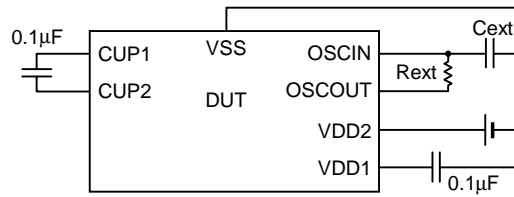

Figure 8 Current dissipation, step-down voltage measurement

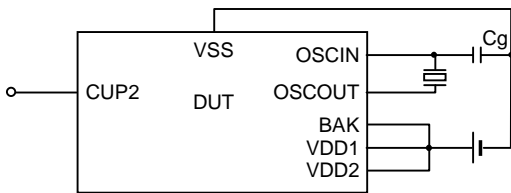

Figure9 Oscillator start-up voltage, oscillator start-up time, oscillator sustaining voltage measurement

- Specifications of any and all SANYO products described or contained herein stipulate the performance, characteristics, and functions of the described products in the independent state, and are not guarantees of the performance, characteristics, and functions of the described products as mounted in the customer's products or equipment. To verify symptoms and states that cannot be evaluated in an independent device, the customer should always evaluate and test devices mounted in the customer's products or equipment.
- SANYO Electric Co., Ltd. strives to supply high-quality high-reliability products. However, any and all semiconductor products fail with some probability. It is possible that these probabilistic failures could give rise to accidents or events that could endanger human lives, that could give rise to smoke or fire, or that could cause damage to other property. When designing equipment, adopt safety measures so that these kinds of accidents or events cannot occur. Such measures include but are not limited to protective circuits and error prevention circuits for safe design, redundant design, and structural design.
- In the event that any or all SANYO products (including technical data, services) described or contained herein are controlled under any of applicable local export control laws and regulations, such products must not be exported without obtaining the export license from the authorities concerned in accordance with the above law.
- No part of this publication may be reproduced or transmitted in any form or by any means, electronic or mechanical, including photocopying and recording, or any information storage or retrieval system, or otherwise, without the prior written permission of SANYO Electric Co., Ltd.
- Any and all information described or contained herein are subject to change without notice due to product/technology improvement, etc. When designing equipment, refer to the "Delivery Specification" for the SANYO product that you intend to use.
- Information (including circuit diagrams and circuit parameters) herein is for example only; it is not guaranteed for volume production. SANYO believes information herein is accurate and reliable, but no guarantees are made or implied regarding its use or any infringements of intellectual property rights or other rights of third parties.

This catalog provides information as of September, 2000. Specifications and information herein are subject to change without notice.