

**SANYO**

No.1704B

**LC5732, 5732H**

4-Bit Microcomputer with LCD Driver

**Overview**

The LC5732, 5732H are CMOS 4-bit microcomputers that operate on low voltage, very low current and contain LCD drivers. They also contain a 4-bit parallel processing ALU, a program memory ROM, many LCD segment outputs, a prescaler, an oscillator.

The LC5732 is especially suited for use in high-grade timepieces, time controllers, electronic calculators, LCD games with timepiece. The LC5732H is especially suited for use in audio equipment, copiers, facsimiles with LCD and sub CPU applications.

**Hardware Features**

- Supply voltage
  - LC5732 : 1.5V or 3.0V typ. (mask option-selectable)
  - LC5732H : 5.0V typ.
- Very low current dissipation
  - LC5732 : 3.0 $\mu$ A typ. (Ag battery version, 32kHz crystal oscillation, during timekeeping operation)
  - 1.5 $\mu$ A typ. (Li battery version, 32kHz crystal oscillation, during timekeeping operation)
  - LC5732H : 10.0 $\mu$ A typ. (32kHz crystal oscillation, during HALT mode)
- LC5732 : Crystal oscillation for timekeeping (32.768kHz crystal connected externally) or CR oscillator
- LC5732H : Crystal oscillation for timekeeping (32.768kHz crystal connected externally), CR oscillator, or CF oscillator
- Many output pins for LCD panel drive (27 pins)

| Drivable LCD panel |          | Number of drivable LCD segments |
|--------------------|----------|---------------------------------|
| 1/2 bias           | 1/3 duty | 81 segments                     |
| 1/2 bias           | 1/2 duty | 54 segments                     |
| Static             |          | 27 segments                     |

Continued on next page.

**Package Dimensions 3057**  
(unit : mm)

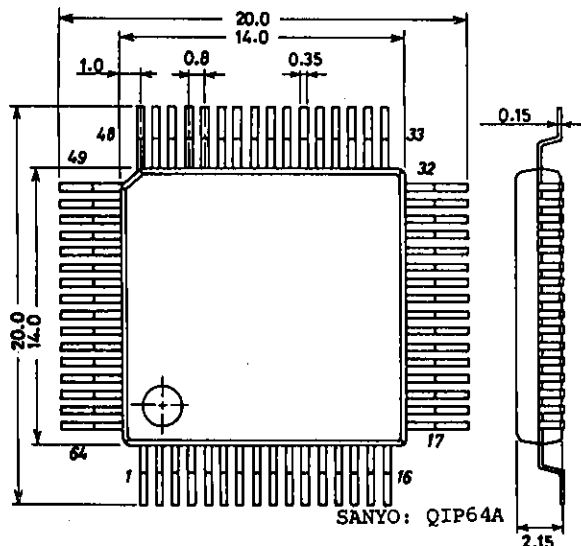

**Package Dimensions 3026B**  
(unit : mm)

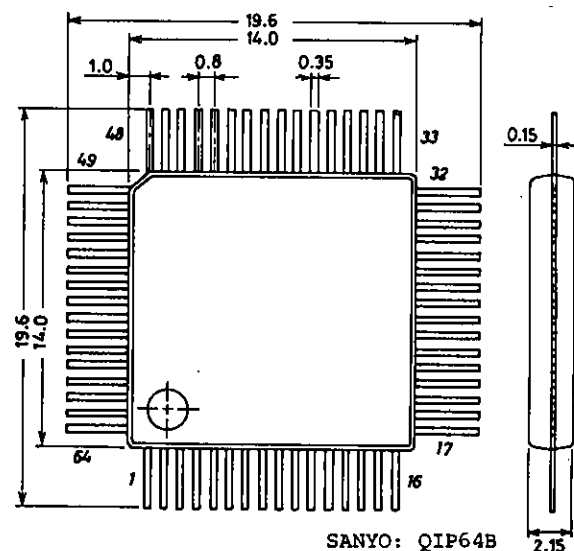

**SANYO Electric Co., Ltd. Semiconductor Business Headquarters**  
TOKYO OFFICE Tokyo Bldg., 1-10, 1 Chome, Ueno, Taito-ku, TOKYO, 110 JAPAN

Continued from preceding page.

- On-chip melody function : 3 octaves (The melody length is software-controlled. One musical note requires one byte.)
- Input/output pins
  - Number of inputs : 8
  - Control output pins : 3 pins (Output dedicated to alarm : 2 pins, general-purpose output : 1 pin)
- Possible to use LCD panel drive output pins as output-only ports (mask option-selectable)
- ROM : 2048×8 bits
- RAM : 48×4 bits
- Cycle time
  - LC5732 : 60 $\mu$ s. CR oscillation 65kHz (122 $\mu$ s. for 32.768kHz crystal)
  - LC5732H : 10 $\mu$ s. (400kHz 5V $\pm$ 10%)
- On-chip step-up circuit/step-down circuit
- Shipping style : When using solder dip or spray techniques to mount QFP64, QFP or chip products on a printed circuit board, please consult your Sanyo sales or technical representative in advance concerning the process conditions to be used.

### Software Features

- Powerful instruction set : 92 instructions
- Table read instruction
- 1-level subroutine nesting
- On-chip 15-bit divider for timekeeping (delivers an overflow signal every 64ms/100ms/500ms when a 32.768kHz crystal is used.)
- HALT function

### **Application Development Support System**

- Evaluation chip (LC5796) is available for application development and the dedicated equipment is available as the application development tools.
- Application development tools
  - (A) MS-DOS personal computer
  - (B) Cross assembler : LC5732. EXE
  - (C) Mask option programmer : SU5732. EXE
- EVA-520 + TB-5734 + DCB-1 (Rev 2.0V or greater) + Application evaluation board + LC5796  
By connecting to the MS-DOS machine, application development program data correction and debugging may be done.
- TB-5734 + DCB-1 (Rev 2.0V or greater) + Application evaluation board + LC5796  
By using the EPROM (2732) with application development program data written in, mounting evaluation may be done.

Note 1 · The application evaluation board is constructed by the user.

- LEDs or LCDs may be used for display.
- The EVA-520 is a modified version of the EVA-410 whose monitor ROM is replaced by the SCR-5734.

Note 2 · Since the evaluation chip LC5796 and the LC5732, 5732H differ in RAM capacity, check the ROM capacity when developing or debugging programs.

LC5732, 5732H : 48×4 bits  
LC5796 : 256×4 bits

- If the DPH value on a program is other than 0, 1, 2, the LC5732, 5732H will malfunction in actual applications.
- When developing programs, take care of the DPH value. The usable DPH values are "0", "1", "2" only.
- We will be free from any blame even if you use DPH = other than 0 to 2 to develop programs.

# LC5732, 5732H

## Equivalent Circuit Block Diagram

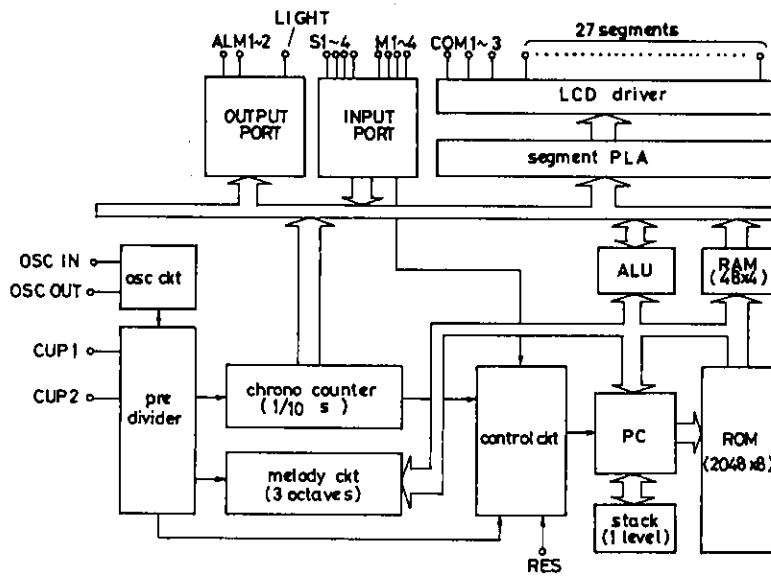

### Pad Assignment of LSI Chip

Chip size : 4.61mm × 3.54mm  
 Chip thickness : 480 $\mu$ m  
 Pad size : 120 $\mu$ m × 120 $\mu$ m

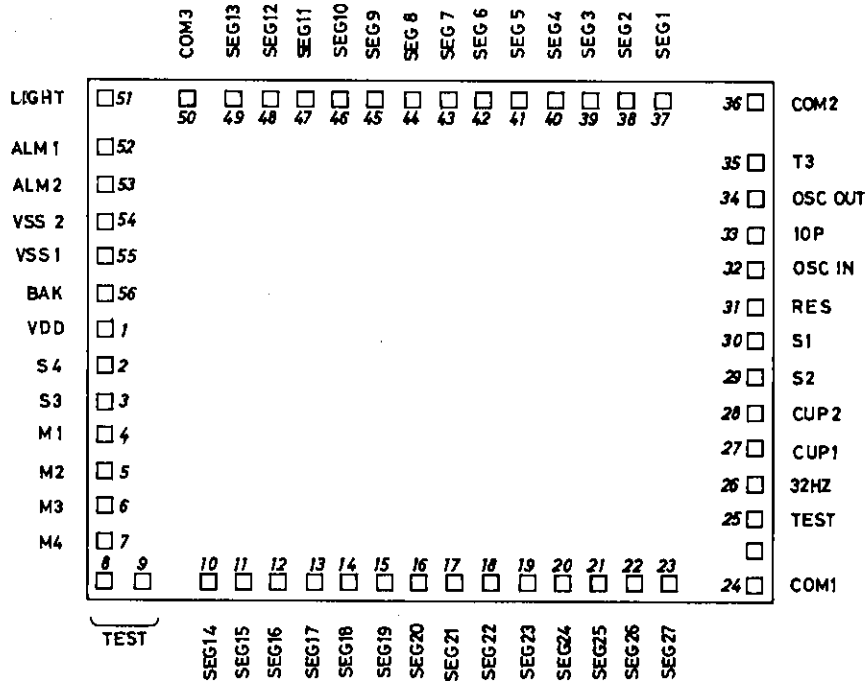

(Note) SEG14 to SEG27 can be used for output ports. (mask option-selectable)

Pad Name and Coordinates

| QFP 64 Pin Description |         |                 |        |        |
|------------------------|---------|-----------------|--------|--------|
|                        | Pad No. | Pin Name        | X (μm) | Y (μm) |
| 56                     | 1       | V <sub>DD</sub> | -2155  | 75     |
| 57                     | 2       | S4              | ∥      | -165   |
| 58                     | 3       | S3              | ∥      | -405   |
| 59                     | 4       | M1              | ∥      | -645   |
| 60                     | 5       | M2              | ∥      | -885   |
| 61                     | 6       | M3              | ∥      | -1125  |
| 62                     | 7       | M4              | ∥      | -1365  |
| 64                     | 8       | TEST            | ∥      | -1620  |
| 1                      | 9       | TEST            | -1915  | ∥      |
| 2                      | 10      | SEG14           | -1465  | ∥      |
| 3                      | 11      | SEG15           | -1230  | ∥      |
| 4                      | 12      | SEG16           | -995   | ∥      |
| 5                      | 13      | SEG17           | -760   | ∥      |
| 6                      | 14      | SEG18           | -525   | ∥      |
| 7                      | 15      | SEG19           | -290   | ∥      |
| 8                      | 16      | SEG20           | -55    | ∥      |
| 9                      | 17      | SEG21           | 180    | ∥      |
| 10                     | 18      | SEG22           | 410    | ∥      |
| 11                     | 19      | SEG23           | 645    | ∥      |
| 12                     | 20      | SEG24           | 880    | ∥      |
| 13                     | 21      | SEG25           | 1115   | ∥      |
| 14                     | 22      | SEG26           | 1350   | ∥      |
| 15                     | 23      | SEG27           | 1585   | ∥      |
| 19                     | 24      | COM1            | 2155   | ∥      |
| 20                     | 25      | TEST            | ∥      | -1190  |
| 21                     | 26      | 32Hz            | ∥      | -950   |
| 22                     | 27      | CUP1            | ∥      | -710   |
| 23                     | 28      | CUP2            | ∥      | -470   |

| QFP 64 Pin Description |         |                  |        |        |
|------------------------|---------|------------------|--------|--------|
|                        | Pad No. | Pin Name         | X (μm) | Y (μm) |
| 25                     | 29      | S2               | 2155   | -230   |
| 26                     | 30      | S1               | ∥      | 10     |
| 27                     | 31      | RES              | ∥      | 250    |
| 28                     | 32      | OSCIN            | ∥      | 490    |
| 29                     | 33      | 10P              | ∥      | 730    |
| 30                     | 34      | OSCOUT           | ∥      | 970    |
| 31                     | 35      | T3               | ∥      | 1210   |
| 32                     | 36      | COM2             | ∥      | 1620   |
| 34                     | 37      | SEG1             | 1530   | ∥      |
| 35                     | 38      | SEG2             | 1295   | ∥      |
| 36                     | 39      | SEG3             | 1060   | ∥      |
| 37                     | 40      | SEG4             | 825    | ∥      |
| 38                     | 41      | SEG5             | 595    | ∥      |
| 39                     | 42      | SEG6             | 360    | ∥      |
| 40                     | 43      | SEG7             | 125    | ∥      |
| 41                     | 44      | SEG8             | -110   | ∥      |
| 42                     | 45      | SEG9             | -355   | ∥      |
| 43                     | 46      | SEG10            | -585   | ∥      |
| 44                     | 47      | SEG11            | -820   | ∥      |
| 45                     | 48      | SEG12            | -1055  | ∥      |
| 46                     | 49      | SEG13            | -1290  | ∥      |
| 47                     | 50      | COM3             | -1615  | ∥      |
| 50                     | 51      | LIGHT            | -2155  | ∥      |
| 51                     | 52      | ALM1             | ∥      | 1275   |
| 52                     | 53      | ALM2             | ∥      | 1035   |
| 53                     | 54      | V <sub>SS2</sub> | ∥      | 795    |
| 54                     | 55      | V <sub>SS1</sub> | ∥      | 555    |
| 55                     | 56      | BAK              | ∥      | 315    |

- The pad coordinates are such that the chip center is taken as the origin and the values for (X, Y) represent the coordinates of the center point of each pad.
- Pin 24 of the QFP64 is connected to the substrate of the LSI.  
Pins 16, 17, 18, 33, 48, 49, 63 are NC pins.
- The substrate, NC pins must not be connected externally.
- When using solder dip or spray techniques to mount QFP64 package products on a printed circuit board, please consult your Sanyo sales or technical representative in advance concerning the process conditions to be used.

Pin Functions

| Pad No. | Pin Name | Input/Output | Circuit Configuration | Function   |
|---------|----------|--------------|-----------------------|--|
| 32      | OSCIN    | Input        |                       | <p>Crystal OSC mode<br/>32.768kHz crystal is connected across OSCIN and OSCOUT for oscillation.<br/>Used as reference clock for timepiece and system clock.</p> <p>CR OSC mode<br/>R and C are connected across OSCIN and OSCOUT for oscillation.<br/>Used as system clock.</p> <p>Ceramic resonator OSC mode (LC5732H only)<br/>Ceramic resonator and R are connected across OSCIN and OSCOUT and C is connected across OSCIN, OSCOUT and V<sub>DD</sub> for oscillation.</p> |
| 34      | OSCOUT   | Output       |                       |  |

Continued on next page.

Continued from preceding page.

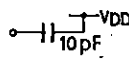
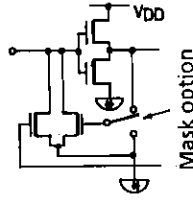
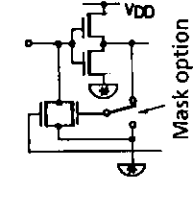
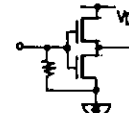
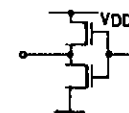
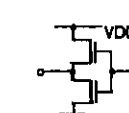
| Pad No.            | Pin Name                             | Input/Output | Circuit Configuration   | Function  |
|--------------------|--------------------------------------|--------------|---|---|
| 33                 | 10P                                  | -            |    | Connected to OSCOUT and used as OSC phase compensation capacitor.   |
| 30<br>29<br>3<br>2 | S1<br>S2<br>S3<br>S4                 | Input        |    | Input-only port.<br>LSI system is reset by applying V <sub>DD</sub> to S1 to S4 simultaneously.   |
| 4<br>5<br>6<br>7   | M1<br>M2<br>M3<br>M4                 | Input        |    | Input pins for placing data in RAM.   |
| 31                 | RES                                  | Input        |   | Input pin for resetting LSI system.   |
| 56                 | BAK                                  |              |   | (-) power supply pin for logic unit inside the LSI.<br>For Li battery version, a capacitor must be connected across BAK and V <sub>DD</sub> to prevent logic unit from malfunctioning.  |
| 51                 | LIGHT                                | Output       |  | Output-only pin<br>Suited for delivering signal to drive transistor for light.  |
| 52<br>53           | ALM1<br>ALM2                         | Output       |  | Output-only pin<br>Used to deliver *4kHz, 2kHz, 1kHz modulation signal with instruction.<br>Also used to deliver non-modulation signal.<br>Used to deliver melody signal of 3 octaves with instruction.                       |
| 1                  | V <sub>DD</sub>                      |              |   | (+) power supply pin.   |
| 54<br>55           | V <sub>SS2</sub><br>V <sub>SS1</sub> |              |   | (-) power supply pin.<br>Ag battery version, Li battery version, EXT-V version : mask option selectable.<br>Also used as power supply for LCD drive.<br>The following Table shows how to connect external parts in each case. |

|                  | Ag bat. use |          | Li bat. use |          | EXT-V use |          |
|------------------|-------------|----------|-------------|----------|-----------|----------|
|                  | static      | 1/2 bias | static      | 1/2 bias | static    | 1/2 bias |
| V <sub>DD</sub>  |             |          |             |          |           |          |
| V <sub>SS1</sub> |             |          |             |          |           |          |
| V <sub>SS2</sub> |             |          |             |          |           |          |

Continued on next page.

Continued from preceding page.

| Pad No.                              | Pin Name             | Input/Output | Circuit Configuration | Function   |  |        |          |          |      |   |   |   |      |   |   |   |      |   |   |   |                       |      |      |      |
|--------------------------------------|----------------------|--------------|-----------------------|--|--|--------|----------|----------|------|---|---|---|------|---|---|---|------|---|---|---|-----------------------|------|------|------|
| 27<br>28                             | CUP1<br>CUP2         |              |                       | Pins for connecting voltage step-up (step-down) capacitor.   |  |        |          |          |      |   |   |   |      |   |   |   |      |   |   |   |                       |      |      |      |
| 24<br>36<br>50                       | COM1<br>COM2<br>COM3 | Output       |                       | <p>Output pins for LCD panel common plate. The following pin is used in each case.</p> <table border="1"> <thead> <tr> <th></th> <th>Static</th> <th>1/2 duty</th> <th>1/3 duty</th> </tr> </thead> <tbody> <tr> <td>COM1</td> <td>○</td> <td>○</td> <td>○</td> </tr> <tr> <td>COM2</td> <td>-</td> <td>○</td> <td>○</td> </tr> <tr> <td>COM3</td> <td>-</td> <td>-</td> <td>○</td> </tr> <tr> <td>Alternating frequency</td> <td>32Hz</td> <td>32Hz</td> <td>43Hz</td> </tr> </tbody> </table> <p>(Alternating frequency is for 32.768kHz crystal OSC application.)</p> |  | Static | 1/2 duty | 1/3 duty | COM1 | ○ | ○ | ○ | COM2 | - | ○ | ○ | COM3 | - | - | ○ | Alternating frequency | 32Hz | 32Hz | 43Hz |
|                                      | Static               | 1/2 duty     | 1/3 duty              |  |  |        |          |          |      |   |   |   |      |   |   |   |      |   |   |   |                       |      |      |      |
| COM1                                 | ○                    | ○            | ○                     |  |  |        |          |          |      |   |   |   |      |   |   |   |      |   |   |   |                       |      |      |      |
| COM2                                 | -                    | ○            | ○                     |  |  |        |          |          |      |   |   |   |      |   |   |   |      |   |   |   |                       |      |      |      |
| COM3                                 | -                    | -            | ○                     |  |  |        |          |          |      |   |   |   |      |   |   |   |      |   |   |   |                       |      |      |      |
| Alternating frequency                | 32Hz                 | 32Hz         | 43Hz                  |  |  |        |          |          |      |   |   |   |      |   |   |   |      |   |   |   |                       |      |      |      |
| 19<br>to<br>23<br><br>37<br>to<br>49 | Segment driver       | Output       |                       | Output pins for LCD panel segments. Mask option permits Seg 14 to Seg 27 (pad No.10 to 23) to be used as output ports.   |  |        |          |          |      |   |   |   |      |   |   |   |      |   |   |   |                       |      |      |      |
| 26<br>35<br>25<br>8<br>9             | 32Hz<br>T3<br>] TEST | Test         |                       | Test pins (not used by user)   |  |        |          |          |      |   |   |   |      |   |   |   |      |   |   |   |                       |      |      |      |

(Note) For Ag battery power supply,  $\downarrow$  is connected to  $V_{SS1}$ ; for Li battery/EXT-V power supply, connected to  $V_{SS2}$ .

\* 4kHz, 2kHz, 1kHz : For 32.768kHz crystal OSC application, proportional to OSC frequency.

- No products described or contained herein are intended for use in surgical implants, life-support systems, aerospace equipment, nuclear power control systems, vehicles, disaster/crime-prevention equipment and the like, the failure of which may directly or indirectly cause injury, death or property loss.
- Anyone purchasing any products described or contained herein for an above-mentioned use shall:
  - ① Accept full responsibility and indemnify and defend SANYO ELECTRIC CO., LTD., its affiliates, subsidiaries and distributors and all their officers and employees, jointly and severally, against any and all claims and litigation and all damages, cost and expenses associated with such use:
  - ② Not impose any responsibility for any fault or negligence which may be cited in any such claim or litigation on SANYO ELECTRIC CO., LTD., its affiliates, subsidiaries and distributors or any of their officers and employees jointly or severally.
- Information (including circuit diagrams and circuit parameters) herein is for example only; it is not guaranteed for volume production. SANYO believes information herein is accurate and reliable, but no guarantees are made or implied regarding its use or any infringements of intellectual property rights or other rights of third parties.

Sample Application Circuits

(1) Ag battery used application  
 (1/2 bias 1/3 duty) \*: 4 segment outputs are used for output ports.

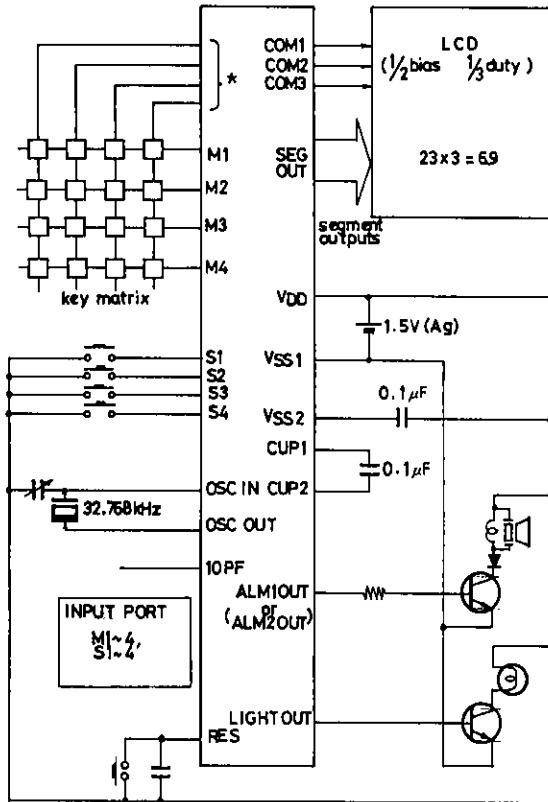

Crystal OSC (Power supply : Ag battery version)

(2) Li battery used application  
 (1/2 bias 1/3 duty) \*: 4 segment outputs are used for output ports.

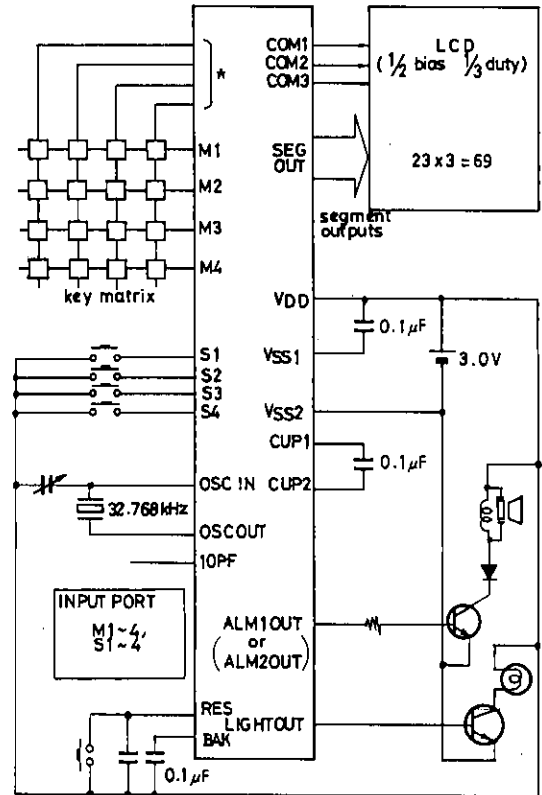

Crystal OSC (Power supply : Li battery version)

(3) EXT-V used application  
 (1/2 bias 1/3 duty) \*: 4 segment outputs are used for output ports.

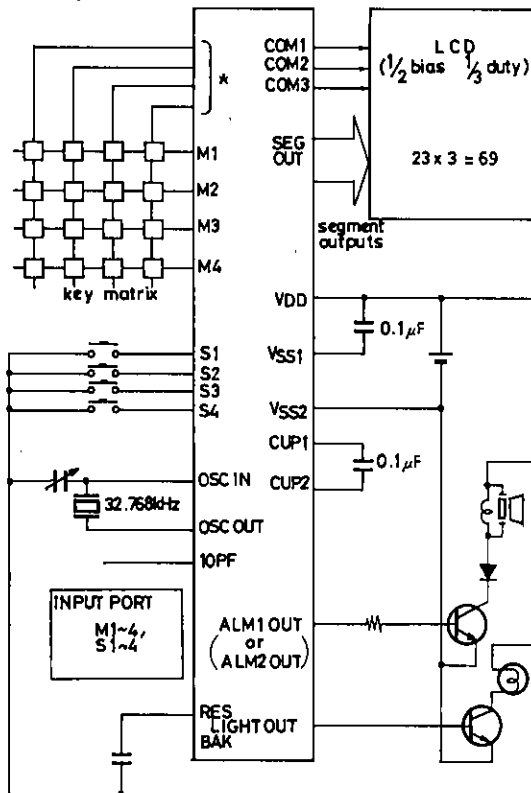

Crystal OSC (Power supply : EXT-V version)

LC5732, 5732H

● Ag Battery Version

Absolute Maximum Ratings at  $T_a = 25 \pm 2^\circ\text{C}$ ,  $V_{DD} = 0\text{V}$

|                        |            |   |                        | unit             |
|------------------------|------------|---|------------------------|------------------|
| Maximum Supply Voltage | $V_{SS1}$  |   | -4.0 to +0.3           | V                |
|                        | $V_{SS2}$  |   | -4.0 to +0.3           | V                |
| Maximum Input Voltage  | $V_{IN}$   | S1-4, M1-4, 32Hz, TEST, 10P, OSCIN, RES | $V_{SS1} - 0.3$ to 0.3 | V                |
| Maximum Output Voltage | $V_{OUT1}$ | 32Hz, CUP2, OSCOUT, ALM1, ALM2, LIGHT   | $V_{SS1} - 0.3$ to 0.3 | V                |
|                        | $V_{OUT2}$ | SEGOUT, COM1, COM2, COM3, CUP1          | $V_{SS2} - 0.3$ to 0.3 | V                |
| Operating Temperature  | $T_{opr}$  |   | -10 to +65             | $^\circ\text{C}$ |
| Storage Temperature    | $T_{stg}$  |   | -30 to +125            | $^\circ\text{C}$ |

Allowable Operating Conditions at  $T_a = 25 \pm 2^\circ\text{C}$ ,  $V_{DD} = 0\text{V}$

|                         |            |  | min       | typ             | max | unit |
|-------------------------|------------|--|-----------|-----------------|-----|------|
| Supply Voltage          | $V_{SS1}$  |  | -1.65     | -1.30           |     | V    |
|                         | $V_{SS2}$  |  | -3.3      | -2.4            |     | V    |
| Input 'H'-Level Voltage | $V_{IH}$   | S1-4, M1-4, RES                                  | -0.2      | 0               |     | V    |
| Input 'L'-Level Voltage | $V_{IL}$   | S1-4, M1-4, RES                                  | $V_{SS1}$ | $V_{SS1} + 0.2$ |     | V    |
| Operating Frequency     | $f_{opg1}$ | $T_a = -10$ to $+65^\circ\text{C}$ , crystal OSC | 32        |                 | 33  | kHz  |
|                         | $f_{opg2}$ | $T_a = -10$ to $+65^\circ\text{C}$ , CR OSC      | 32.768    |                 |     | kHz  |

Electrical Characteristics at  $T_a = 25 \pm 2^\circ\text{C}$ ,  $V_{DD} = 0\text{V}$

|                                      |            |  | min             | typ              | max   | unit          |
|--------------------------------------|------------|--|-----------------|------------------|-------|---------------|
| Input Resistance                     | $R_{IN1A}$ | $V_{SS1} = -1.55\text{V}$ , $V_{IL} = V_{SS1} + 0.2\text{V}$ ,<br>'L' level hold tr., *1, Fig.1  | 200             |                  | 2000  | k $\Omega$    |
|                                      | $R_{IN1B}$ | $V_{SS1} = -1.55\text{V}$ ,<br>'L' level pull-in tr., *1, Fig.1  | 200             |                  | 2000  | k $\Omega$    |
|                                      | $R_{IN2}$  | $V_{SS1} = -1.55\text{V}$ , TEST, RES  | 10              |                  | 300   | k $\Omega$    |
| Output 'H'-Level Voltage             | $V_{OH1}$  | $V_{SS1} = -1.55\text{V}$ , $I_{OH} = -0.4\mu\text{A}$ , *2  | -0.2            |                  |       | V             |
| Output 'L'-Level Voltage             | $V_{OL1}$  | $V_{SS1} = -1.55\text{V}$ , $I_{OL} = 0.4\mu\text{A}$ , *2   |                 | $V_{SS2} + 0.2$  |       | V             |
| Output 'H'-Level Voltage             | $V_{OH2}$  | $V_{SS1} = -1.55\text{V}$ , $I_{OH} = -4\mu\text{A}$ ,<br>COM1, COM2, COM3   | -0.2            |                  |       | V             |
| Output 'M'-Level Voltage             | $V_{OM}$   | $V_{SS1} = -1.55\text{V}$ , $I_{OH} = -4\mu\text{A}$ ,<br>$I_{OL} = 4\mu\text{A}$ , COM1, COM2, COM3   | $V_{SS1} - 0.2$ | $V_{SS1} + 0.2$  |       | V             |
| Output 'L'-Level Voltage             | $V_{OL2}$  | $V_{SS1} = -1.55\text{V}$ , $I_{OL} = 4\mu\text{A}$ ,<br>COM1, COM2, COM3  |                 | $V_{SS2} + 0.2$  |       | V             |
| Output 'H'-Level Voltage             | $V_{OH3}$  | $V_{SS1} = -1.35\text{V}$ , $I_{OH} = -250\mu\text{A}$ ,<br>ALM1, ALM2, LIGHT  | -0.65           |                  |       | V             |
| Output 'L'-Level Voltage             | $V_{OL3}$  | $V_{SS1} = -1.35\text{V}$ , $I_{OL} = 150\mu\text{A}$ ,<br>ALM1, ALM2, LIGHT   |                 | $V_{SS1} + 0.65$ |       | V             |
| Output 'H'-Level Voltage             | $V_{OH4}$  | $V_{SS1} = -1.55\text{V}$ , $I_{OH} = -20\mu\text{A}$ , *3   | -0.2            |                  |       | V             |
| Output 'L'-Level Voltage             | $V_{OL4}$  | $V_{SS1} = -1.55\text{V}$ , $I_{OL} = 20\mu\text{A}$ , *3  |                 | $V_{SS1} + 0.2$  |       | V             |
| Output Voltage                       | $V_{SS2}$  | $V_{SS1} = -1.35\text{V}$ ,<br>$C1 = C2 = 0.1\mu\text{F}$ , $f_{opg} = 32.768\text{kHz}$ , Fig.2   | -3.3            |                  | -2.5  | V             |
| Current Dissipation                  | $I_{DD}$   | $V_{SS1} = -1.55\text{V}$ , $C1 = C2 = 0.1\mu\text{F}$ ,<br>$C_o = C_g = 20\text{pF}$ , $C_I \leq 25\text{k}\Omega$ , crystal OSC,<br>HALT mode, Fig.2 |                 | 2.0              |       | $\mu\text{A}$ |
| Oscillation Start Voltage            | $V_{stt}$  | $C_o = C_g = 20\text{pF}$ , crystal OSC ( $C_I \leq 25\text{k}\Omega$ ),<br>Fig.3  | -1.35           |                  |       | V             |
| Oscillation Hold Voltage             | $V_{HOLD}$ | $C_o = C_g = 20\text{pF}$ , crystal OSC ( $C_I \leq 25\text{k}\Omega$ ),<br>Fig.3  | -1.65           |                  | -1.30 | V             |
| Oscillation Start Time               | $t_{stt}$  | $C_o = C_g = 20\text{pF}$ , crystal OSC ( $C_I \leq 25\text{k}\Omega$ ),<br>Fig.3  |                 |                  | 10    | s             |
| Oscillation Compensation Capacitance | 10P        | External pin   | 8               | .10              | 12    | pF            |

Notes for developing an LC5730 series microcomputer-used system

The low current dissipation is a distinctive feature of the LC5730 series microcomputers. However, it is not easy to determine the total current to be dissipated in an LC5730 series microcomputer-used system by actual measurement when you develop a software, because much current flows in the peripherals of the evaluation tools.

For a system which requires low current dissipation, check the current dissipation using an evaluation sample before mass-producing the system.



● Li Battery Version

Absolute Maximum Ratings at  $T_a = 25 \pm 2^\circ\text{C}$ ,  $V_{DD} = 0\text{V}$

|                        |            |   | unit                     |
|------------------------|------------|---|--------------------------|
| Maximum Supply Voltage | $V_{SS1}$  | -4.0 to +0.3                                      | V                        |
|                        | $V_{SS2}$  | -4.0 to +0.3                                      | V                        |
| Maximum Input Voltage  | $V_{IN1}$  | 10P, OSCIN, 32Hz                                  | $V_{SS1} - 0.3$ to 0.3 V |
|                        | $V_{IN2}$  | S1-4, M1-4, TEST, RES                             | $V_{SS2} - 0.3$ to 0.3 V |
| Maximum Output Voltage | $V_{OUT1}$ | 32Hz, CUP2, OSCOUT                                | $V_{SS1} - 0.3$ to 0.3 V |
|                        | $V_{OUT2}$ | SEGOUT, COM1, COM2, COM3, CUP1, LIGHT, ALM1, ALM2 | $V_{SS2} - 0.3$ to 0.3 V |
| Operating Temperature  | $T_{opr}$  | -10 to +65  | $^\circ\text{C}$         |
| Storage Temperature    | $T_{stg}$  | -30 to +125                                       | $^\circ\text{C}$         |

Allowable Operating Conditions at  $T_a = 25 \pm 2^\circ\text{C}$ ,  $V_{DD} = 0\text{V}$

|                         |            | min  | typ       | max             | unit |
|-------------------------|------------|------|-----------|-----------------|------|
| Supply Voltage          | $V_{SS1}$  | -3.6 |           | -1.3            | V    |
|                         | $V_{SS2}$  | -3.6 |           | -2.0            | V    |
| Input 'H'-Level Voltage | $V_{IH}$   | -0.4 |           | 0               | V    |
| Input 'L'-Level Voltage | $V_{IL}$   |      | $V_{SS2}$ | $V_{SS2} + 0.4$ | V    |
| Operating Frequency     | $f_{opg1}$ |      | 32        | 33              | kHz  |

Electrical Characteristics at  $T_a = 25 \pm 2^\circ\text{C}$ ,  $V_{DD} = 0\text{V}$

|                                      |            | min               | typ              | max               | unit          |
|--------------------------------------|------------|-------------------|------------------|-------------------|---------------|
| Input Resistance                     | $R_{IN1A}$ | 200               |                  | 2000              | k $\Omega$    |
|                                      | $R_{IN1B}$ | 100               |                  | 2000              | k $\Omega$    |
|                                      | $R_{IN2}$  | 10                |                  | 300               | k $\Omega$    |
| Output 'H'-Level Voltage             | $V_{OH1}$  | -0.2              |                  |                   | V             |
| Output 'L'-Level Voltage             | $V_{OL1}$  |                   | $V_{SS2} + 0.2$  |                   | V             |
| Output 'H'-Level Voltage             | $V_{OH2}$  | -0.2              |                  |                   | V             |
| Output 'M'-Level Voltage             | $V_{OM}$   | $V_{SS2}/2 - 0.2$ |                  | $V_{SS2}/2 + 0.2$ | V             |
| Output 'L'-Level Voltage             | $V_{OL2}$  |                   | $V_{SS2} + 0.2$  |                   | V             |
| Output 'H'-Level Voltage             | $V_{OH3}$  | -0.65             |                  |                   | V             |
| Output 'L'-Level Voltage             | $V_{OL3}$  |                   | $V_{SS2} + 0.65$ |                   | V             |
| Output 'H'-Level Voltage             | $V_{OH4}$  | -1.5              |                  |                   | V             |
| Output 'L'-Level Voltage             | $V_{OL4}$  |                   | $V_{SS2} + 1.5$  |                   | V             |
| Output 'H'-Level Voltage             | $V_{OH5}$  | -0.4              |                  |                   | V             |
| Output 'L'-Level Voltage             | $V_{OL5}$  |                   | $V_{SS2} + 0.4$  |                   | V             |
| Output Voltage (halver)              | $V_{SS1}$  |                   |                  | -1.35             | V             |
| Current Dissipation                  | $I_{DD}$   |                   | 0.8              | 1.5               | $\mu\text{A}$ |
| Oscillation Start Voltage            | $V_{stt}$  | -1.35             |                  |                   | V             |
| Oscillation Hold Voltage             | $V_{HOLD}$ |                   |                  | -2.6              | V             |
| Oscillation Start Time               | $t_{stt}$  |                   |                  | 10                | s             |
| Oscillation Compensation Capacitance | 10P        | 8                 | 10               | 12                | pF            |

LC5732, 5732H

●EXT-V Version

Absolute Maximum Ratings at Ta = 25 ± 2°C, VDD = 0V

|                        |      |   | unit                |
|------------------------|------|---|---------------------|
| Maximum Supply Voltage | VSS1 | -4.0 to +0.3  | V                   |
|                        | VSS2 | -4.0 to +0.3  | V                   |
| Maximum Input Voltage  | VIN  | 10P, OSCIN, 32Hz,<br>S1-4, M1-4, TEST, RES                                  | VSS2 - 0.3 to 0.3 V |
| Maximum Output Voltage | VOU  | 32Hz, CUP2, OSCOUT,<br>SEGOUT, COM1, COM2, COM3, CUP1,<br>LIGHT, ALM1, ALM2 | VSS2 - 0.3 to 0.3 V |
| Operating Temperature  | Topr | -30 to +70  | °C                  |
| Storage Temperature    | Tstg | -40 to +125   | °C                  |

Allowable Operating Conditions at Ta = 25 ± 2°C, VDD = 0V

|                         |       | min  | typ    | max        | unit |
|-------------------------|-------|------|--------|------------|------|
| Supply Voltage          | VSS1  | -3.6 | -1.3   |            | V    |
|                         | VSS2  | -3.6 | -2.0   |            | V    |
| Input 'H'-Level Voltage | VIH   | -0.4 |        | 0          | V    |
| Input 'L'-Level Voltage | VIL   |      | VSS2   | VSS2 + 0.4 | V    |
| Operating Frequency     | fopg1 |      | 32     | 33         | kHz  |
|                         | fopg2 |      | 32.768 |            | kHz  |

Electrical Characteristics at Ta = 25 ± 2°C, VDD = 0V

|                                      |       | min          | typ          | max         | unit |
|--------------------------------------|-------|--------------|--------------|-------------|------|
| Input Resistance                     | RIN1A | 200          |              | 2000        | kΩ   |
|                                      | RIN1B | 100          |              | 2000        | kΩ   |
|                                      | RIN3  | 10           |              | 300         | kΩ   |
| Output 'H'-Level Voltage             | VOH1  | -0.2         |              |             | V    |
| Output 'L'-Level Voltage             | VOL1  |              | VSS2         | VSS2 + 0.2  | V    |
| Output 'H'-Level Voltage             | VOH2  | -0.2         |              |             | V    |
| Output 'M'-Level Voltage             | VOM   | VSS2/2 - 0.2 | VSS2/2 + 0.2 |             | V    |
| Output 'L'-Level Voltage             | VOL2  |              | VSS2         | VSS2 + 0.2  | V    |
| Output 'H'-Level Voltage             | VOH3  | -0.65        |              |             | V    |
| Output 'L'-Level Voltage             | VOL3  |              | VSS2         | VSS2 + 0.65 | V    |
| Output 'H'-Level Voltage             | VOH4  | -1.5         |              |             | V    |
| Output 'L'-Level Voltage             | VOL4  |              | VSS2         | VSS2 + 1.5  | V    |
| Output 'H'-Level Voltage             | VOH5  | -0.4         |              |             | V    |
| Output 'L'-Level Voltage             | VOL5  |              | VSS2         | VSS2 + 0.4  | V    |
| Output Voltage (halver)              | VSS1  |              |              | -1.35       | V    |
| Current Dissipation                  | IDD   |              | 5.0          |             | μA   |
| Oscillation Start Voltage            | Vstt  | -2.2         |              |             | V    |
| Oscillation Hold Voltage             | VHOLD |              |              | -2.0        | V    |
| Oscillation Start Time               | tstt  |              |              | 10          | s    |
| Oscillation Compensation Capacitance | 10P   | 8            | 10           | 12          | pF   |

※1 S1, S2, S3, S4 ; M1, M2, M3, M4

※2 LCD driver output pins out of SEGOUT1 to 13 and SEGOUT14 to 27

※3 Output pins out of SEGOUT14 to 27

Specifications for LC5732

●EXT-V Version 1 [Crystal OSC]

Absolute Maximum Ratings at Ta = 25 ± 2°C, VDD = 0V

|                        |      |  |                   | unit |
|------------------------|------|--|-------------------|------|
| Maximum Supply Voltage | VSS1 |  | -7.0 to +0.3      | V    |
|                        | VSS2 |  | -7.0 to +0.3      | V    |
| Maximum Input Voltage  | VIN  | 10P, OSCIN, 32Hz, S1-4, M1-4,<br>TEST, RES                               | VSS2 - 0.3 to 0.3 | V    |
| Maximum Output Voltage | VOU  | 32Hz, CUP2, OSCOUT, SEGOUT, COM1,<br>COM2, COM3, CUP1, LIGHT, ALM1, ALM2 | VSS2 - 0.3 to 0.3 | V    |
| Operating Temperature  | Topr |  | -30 to +70        | °C   |
| Storage Temperature    | Tstg |  | -40 to +125       | °C   |

Allowable Operating Conditions at Ta = -30 to +70°C, VDD = 0V

|                         |      |  | min         | typ  | max         | unit |
|-------------------------|------|--|-------------|------|-------------|------|
| Supply Voltage          | VSS1 |  | -6.0        |      | -1.3        | V    |
|                         | VSS2 |  | -6.0        |      | -2.0        | V    |
| Input 'H'-Level Voltage | VIH1 | S1-4, M1-4, RES                                | 0.3 × VSS2  |      | 0           | V    |
| Input 'L'-Level Voltage | VIL1 | S1-4, M1-4, RES                                |             | VSS2 | 0.7 × VSS2  | V    |
| Input 'H'-Level Voltage | VIH2 | RES  | 0.25 × VSS2 |      | 0           | V    |
| Input 'L'-Level Voltage | VIL2 | RES  |             | VSS2 | 0.75 × VSS2 | V    |
| Operating Frequency     | fopg | Crystal OSC<br>(recommended OSC circuit Fig.7) | 32          |      | 33          | kHz  |

Electrical Characteristics at Ta = -30 to +70°C, VDD = 0V

|   |       |   | min          | typ          | max  | unit |
|---|-------|---|--------------|--------------|------|------|
| Input Resistance                        | RIN1A | VSS2 = -5.0V, VIL = VSS2 + 0.4V,<br>'L' level hold tr., *1, Fig.4                             | 100          |              | 1000 | kΩ   |
|   | RIN1B | VSS2 = -5.0V,<br>'L' level pull-in tr., *1, Fig.4   | 100          |              | 1000 | kΩ   |
|   | RIN2  | VSS2 = -5.0V, TEST, RES   | 10           |              | 300  | kΩ   |
| Output 'H'-Level Voltage                | VOH1  | VSS2 = -5.0V, IOH = -0.4μA, *2  | -0.2         |              |      | V    |
| Output 'L'-Level Voltage                | VOL1  | VSS2 = -5.0V, IOL = 0.4μA, *2   |              | VSS2 + 0.2   |      | V    |
| Output 'H'-Level Voltage                | VOH2  | VSS2 = -5.0V, IOH = -4μA,<br>COM1, COM2, COM3   | -0.2         |              |      | V    |
| Output 'M'-Level Voltage                | VOM   | VSS2 = -5.0V, IOH = -4μA,<br>IOL = 4μA, COM1, COM2, COM3                                      | VSS2/2 - 0.2 | VSS2/2 + 0.2 |      | V    |
| Output 'L'-Level Voltage                | VOL2  | VSS2 = -5.0V, IOL = 4μA,<br>COM1, COM2, COM3  |              | VSS2 + 0.2   |      | V    |
| Output 'H'-Level Voltage                | VOH3  | VSS2 = -5.0V, IOH = -2.0mA,<br>ALM1, ALM2   | -1.0         |              |      | V    |
| Output 'L'-Level Voltage                | VOL3  | VSS2 = -5.0V, IOL = 2.0mA,<br>ALM1, ALM2  |              | VSS2 + 1.0   |      | V    |
| Output 'H'-Level Voltage                | VOH4  | VSS2 = -5.0V, IOH = -250μA, LIGHT   | -1.5         |              |      | V    |
| Output 'L'-Level Voltage                | VOL4  | VSS2 = -5.0V, IOL = 250μA, LIGHT  |              | VSS2 + 1.5   |      | V    |
| Output 'H'-Level Voltage                | VOH5  | VSS2 = -5.0V, IOH = -80μA, *3   | -0.8         |              |      | V    |
| Output 'L'-Level Voltage                | VOL5  | VSS2 = -5.0V, IOL = 80μA, *3  |              | VSS2 + 0.8   |      | V    |
| Output Voltage<br>(halver)              | VSS1  | VSS2 = -5.0V,<br>C1 = C2 = 0.1μF, fopg = 32.768kHz, Fig.5                                     |              |              | -2.4 | V    |
| Current Dissipation                     | IDD   | VSS2 = -5.0V, crystal OSC, HALT mode,<br>C1 = C2 = 0.1μF, Co = Cg = 20pF, CI ≤ 25kΩ,<br>Fig.5 |              | 10.0         |      | μA   |
| Oscillation Start Voltage               | Vstt  | Co = Cg = 20pF, crystal OSC (CI ≤ 25kΩ),<br>Fig.6   | -2.3         |              |      | V    |
| Oscillation Hold Voltage                | VHOLD | Co = Cg = 20pF, crystal OSC (CI ≤ 25kΩ),<br>Fig.6   |              |              | -2.0 | V    |
| Oscillation Start Time                  | tstt  | VSS2 = -2.3V, Co = Cg = 20pF,<br>crystal OSC (CI ≤ 25kΩ), Fig.6                               |              |              | 10   | s    |
| Oscillation Compensation<br>Capacitance | 10P   | External pin  | 8            | 10           | 12   | pF   |

\*1 S1, S2, S3, S4 ; M1, M2, M3, M4

\*2 LCD driver output pins out of SEGOUT1 to 13 and SEGOUT14 to 27

\*3 Output pins out of SEGOUT14 to 27

LC5732, 5732H

●EXT-V Version 2 [Ceramic resonator OSC] ※0

Absolute Maximum Ratings at Ta = 25 ± 2°C, VDD = 0V

|                        |      |   |                   | unit |
|------------------------|------|---|-------------------|------|
| Maximum Supply Voltage | VSS1 |   | -7.0 to +0.3      | V    |
|                        | VSS2 |   | -7.0 to +0.3      | V    |
| Maximum Input Voltage  | VIN  | 10P, OSCIN, 32Hz, S1-4, M1-4, TEST, RES                               | VSS2 - 0.3 to 0.3 | V    |
|                        | VOUT | 32Hz, CUP2, OSCOUT, SEGOUT, COM1, COM2, COM3, CUP1, LIGHT, ALM1, ALM2 | VSS2 - 0.3 to 0.3 | V    |
| Operating Temperature  | Topr |   | -30 to +70        | °C   |
| Storage Temperature    | Tstg |   | -40 to +125       | °C   |

Allowable Operating Conditions at Ta = -30 to +70°C, VDD = 0V

|                                  |      |  | min         | typ  | max         | unit |
|----------------------------------|------|--|-------------|------|-------------|------|
| Supply Voltage                   | VSS1 |  | -6.0        |      | -2.0        | V    |
|                                  | VSS2 |  | -6.0        |      | -4.0        | V    |
| Input 'H'-Level Voltage          | VIH1 | S1-4, M1-4                             | 0.3 × VSS2  |      | 0           | V    |
| Input 'L'-Level Voltage          | VIL1 | S1-4, M1-4                             |             | VSS2 | 0.7 × VSS2  | V    |
| Input 'H'-Level Voltage          | VIH2 | RES                                    | 0.25 × VSS2 |      | 0           | V    |
| Input 'L'-Level Voltage          | VIL2 | RES                                    |             | VSS2 | 0.75 × VSS2 | V    |
| Operating Frequency              | fopg | Using recommended ceramic resonator ※0 | 380         | 400  | 420         | kHz  |
| (Recommended OSC circuit Fig.12) |      |  |             |      |             |      |

Electrical Characteristics at Ta = -30 to +70°C, VDD = 0V

|  |       |   | min          | typ         | max          | unit |
|--|-------|---|--------------|-------------|--------------|------|
| Input Resistance                               | RIN1A | VSS2 = -5.0V, VIL = VSS2 + 0.4V, 'L' level hold tr., ※1, Fig.4                          | 100          |             | 1000         | kΩ   |
|  | RIN1B | VSS2 = -5.0V, 'L' level pull-in tr., ※1, Fig.4  | 100          |             | 1000         | kΩ   |
|  | RIN2  | VSS2 = -5.0V, TEST, RES   | 10           |             | 300          | kΩ   |
| Output 'H'-Level Voltage                       | VOH1  | VSS2 = -5.0V, IOH = -0.4μA, ※2  | -0.2         |             |              | V    |
| Output 'L'-Level Voltage                       | VOL1  | VSS2 = -5.0V, IOL = 0.4μA, ※2   |              | VSS2 + 0.2  |              | V    |
| Output 'H'-Level Voltage                       | VOH2  | VSS2 = -5.0V, IOH = -4μA, COM1, COM2, COM3  | -0.2         |             |              | V    |
| Output 'M'-Level Voltage                       | VOM   | VSS2 = -5.0V, IOH = -4μA, IOL = 4μA, COM1, COM2, COM3                                   | VSS2/2 - 0.2 |             | VSS2/2 + 0.2 | V    |
| Output 'L'-Level Voltage                       | VOL2  | VSS2 = -5.0V, IOL = 4μA, COM1, COM2, COM3   |              | VSS2 + 0.2  |              | V    |
| Output 'H'-Level Voltage                       | VOH3  | VSS2 = -5.0V, IOH = -2.0mA, ALM1, ALM2  | -1.0         |             |              | V    |
| Output 'L'-Level Voltage                       | VOL3  | VSS2 = -5.0V, IOL = 2.0mA, ALM1, ALM2   |              | VSS2 + 1.0  |              | V    |
| Output 'H'-Level Voltage                       | VOH4  | VSS2 = -5.0V, IOH = -250μA, LIGHT   | -1.50        |             |              | V    |
| Output 'L'-Level Voltage                       | VOL4  | VSS2 = -5.0V, IOL = 250μA, LIGHT  |              | VSS2 + 1.50 |              | V    |
| Output 'H'-Level Voltage                       | VOH5  | VSS2 = -5.0V, IOH = -80μA, ※3   | -0.8         |             |              | V    |
| Output 'L'-Level Voltage                       | VOL5  | VSS2 = -5.0V, IOL = 80μA, ※3  |              | VSS2 + 0.8  |              | V    |
| Output Voltage (halver)                        | VSS1  | VSS2 = -5.0V, C1 = C2 = 0.1μF, fopg = 400kHz, Fig.9                                     |              |             | -2.4         | V    |
| Current Dissipation                            | IDD   | VSS2 = -5.0V, ceramic resonator OSC, HALT mode, C1 = C2 = 0.1μF, Co = Cg = 100pF, Fig.9 |              | 50          |              | μA   |
| Oscillation Start Voltage                      | Vstt  | Co = Cg = 100pF, ceramic resonator OSC, Fig.10  | -3.0         |             |              | V    |
| Oscillation Hold Voltage                       | VHOLD | Co = Cg = 100pF, ceramic resonator OSC, Fig.10  |              |             | -3.0         | V    |
| Oscillation Start Time                         | tstt  | VSS2 = -3.0V, Co = Cg = 100pF, ceramic resonator OSC, Fig.10                            |              |             | 10           | s    |
| External Capacitance for Ceramic Resonator OSC | Co    | Fig.12  | 100 ± 10%    |             |              | pF   |
|  | Cg    | Fig.12  | 100 ± 10%    |             |              | pF   |
| External Resistance for Ceramic Resonator OSC  | R     | Fig.12  | 1000 ± 5%    |             |              | kΩ   |

※0 Recommended ceramic resonator : CSB400P (Murata), KBR400B (Kyocera)

※1 S1, S2, S3, S4 ; M1, M2, M3, M4

※2 LCD driver output pins out of SEGOUT1 to 13 and SEGOUT14 to 27

※3 Output pins out of SEGOUT14 to 27

LC5732, 5732H

● EXT-V Version 3 [CR OSC]

Absolute Maximum Ratings at  $T_a = 25 \pm 2^\circ\text{C}$ ,  $V_{DD} = 0\text{V}$

|                        |           |   |                        | unit             |
|------------------------|-----------|---|------------------------|------------------|
| Maximum Supply Voltage | $V_{SS1}$ |   | -7.0 to +0.3           | V                |
|                        | $V_{SS2}$ |   | -7.0 to +0.3           | V                |
| Maximum Input Voltage  | $V_{IN}$  | 10P, OSCIN, 32Hz, S1-4, M1-4, TEST, RES                               | $V_{SS2} - 0.3$ to 0.3 | V                |
| Maximum Output Voltage | $V_{OUT}$ | 32Hz, CUP2, OSCOUT, SEGOUT, COM1, COM2, COM3, CUP1, LIGHT, ALM1, ALM2 | $V_{SS2} - 0.3$ to 0.3 | V                |
| Operating Temperature  | $T_{opr}$ |   | -30 to +70             | $^\circ\text{C}$ |
| Storage Temperature    | $T_{stg}$ |   | -40 to +125            | $^\circ\text{C}$ |

Allowable Operating Conditions at  $T_a = -30$  to  $+70^\circ\text{C}$ ,  $V_{DD} = 0\text{V}$

|                         |           |   | min                   | typ                   | max  | unit |
|-------------------------|-----------|---|-----------------------|-----------------------|------|------|
| Supply Voltage          | $V_{SS1}$ |   | -6.0                  |                       | -1.3 | V    |
|                         | $V_{SS2}$ |   | -6.0                  |                       | -2.5 | V    |
| Input 'H'-Level Voltage | $V_{IH1}$ | S1-4, M1-4                                | $0.3 \times V_{SS2}$  |                       | 0    | V    |
| Input 'L'-Level Voltage | $V_{IL1}$ | S1-4, M1-4                                | $V_{SS2}$             | $0.7 \times V_{SS2}$  |      | V    |
| Input 'H'-Level Voltage | $V_{IH2}$ | RES                                       | $0.25 \times V_{SS2}$ |                       | 0    | V    |
| Input 'L'-Level Voltage | $V_{IL2}$ | RES                                       | $V_{SS2}$             | $0.75 \times V_{SS2}$ |      | V    |
| Operating Frequency     | $f_{opg}$ | Using recommended CR OSC circuit (Fig.11) | 100                   | 250                   | 400  | kHz  |

Electrical Characteristics at  $T_a = -30$  to  $+70^\circ\text{C}$ ,  $V_{DD} = 0\text{V}$

|                                 |            |  | min               | typ               | max  | unit          |
|---------------------------------|------------|--|-------------------|-------------------|------|---------------|
| Input Resistance                | $R_{IN1A}$ | $V_{SS2} = -5.0\text{V}$ , $V_{IL} = V_{SS2} + 0.4\text{V}$ , 'L' level hold tr., *1, Fig.4                            | 100               |                   | 1000 | k $\Omega$    |
|                                 | $R_{IN1B}$ | $V_{SS2} = -5.0\text{V}$ , 'L' level pull-in tr., *1, Fig.4  | 100               |                   | 1000 | k $\Omega$    |
|                                 | $R_{IN2}$  | $V_{SS2} = -5.0\text{V}$ , TEST, RES   | 10                |                   | 300  | k $\Omega$    |
| Output 'H'-Level Voltage        | $V_{OH1}$  | $V_{SS2} = -5.0\text{V}$ , $I_{OH} = -0.4\mu\text{A}$ , *2   | -0.2              |                   |      | V             |
| Output 'L'-Level Voltage        | $V_{OL1}$  | $V_{SS2} = -5.0\text{V}$ , $I_{OL} = 0.4\mu\text{A}$ , *2  |                   | $V_{SS2} + 0.2$   |      | V             |
| Output 'H'-Level Voltage        | $V_{OH2}$  | $V_{SS2} = -5.0\text{V}$ , $I_{OH} = -4\mu\text{A}$ , COM1, COM2, COM3   | -0.2              |                   |      | V             |
| Output 'M'-Level Voltage        | $V_{OM}$   | $V_{SS2} = -5.0\text{V}$ , $I_{OH} = -4\mu\text{A}$ , $I_{OL} = 4\mu\text{A}$ , COM1, COM2, COM3                       | $V_{SS2}/2 - 0.2$ | $V_{SS2}/2 + 0.2$ |      | V             |
| Output 'L'-Level Voltage        | $V_{OL2}$  | $V_{SS2} = -5.0\text{V}$ , $I_{OL} = 4\mu\text{A}$ , COM1, COM2, COM3  |                   | $V_{SS2} + 0.2$   |      | V             |
| Output 'H'-Level Voltage        | $V_{OH3}$  | $V_{SS2} = -5.0\text{V}$ , $I_{OH} = -2.0\text{mA}$ , ALM1, ALM2   | -1.0              |                   |      | V             |
| Output 'L'-Level Voltage        | $V_{OL3}$  | $V_{SS2} = -5.0\text{V}$ , $I_{OL} = 2.0\text{mA}$ , ALM1, ALM2  |                   | $V_{SS2} + 1.0$   |      | V             |
| Output 'H'-Level Voltage        | $V_{OH4}$  | $V_{SS2} = -5.0\text{V}$ , $I_{OH} = -250\mu\text{A}$ , LIGHT  | -1.50             |                   |      | V             |
| Output 'L'-Level Voltage        | $V_{OL4}$  | $V_{SS2} = -5.0\text{V}$ , $I_{OL} = 250\mu\text{A}$ , LIGHT   |                   | $V_{SS2} + 1.50$  |      | V             |
| Output 'H'-Level Voltage        | $V_{OH5}$  | $V_{SS2} = -5.0\text{V}$ , $I_{OH} = -80\mu\text{A}$ , *3  | -0.8              |                   |      | V             |
| Output 'L'-Level Voltage        | $V_{OL5}$  | $V_{SS2} = -5.0\text{V}$ , $I_{OL} = 80\mu\text{A}$ , *3   |                   | $V_{SS2} + 0.8$   |      | V             |
| Output Voltage (halver)         | $V_{SS1}$  | $V_{SS2} = -5.0\text{V}$ , $R_{ext} = 91\text{k}\Omega$ , $C_{ext} = 30\text{pF}$ , $C1 = C2 = 0.1\mu\text{F}$ , Fig.8 |                   |                   | -2.4 | V             |
| Current Dissipation             | $I_{DD}$   | $V_{SS2} = -5.0\text{V}$ , $R_{ext} = 91\text{k}\Omega$ , $C_{ext} = 30\text{pF}$ , Fig.8                              |                   | 250               |      | $\mu\text{A}$ |
| External Capacitance for CR OSC | $C_{ext}$  | Fig.11   | 10                | 30                | 100  | pF            |
| External Resistance for CR OSC  | $R_{ext}$  | Fig.11   | 30                | 91                | 200  | k $\Omega$    |

\*1 S1, S2, S3, S4 ; M1, M2, M3, M4

\*2 LCD driver output pins out of SEGOUT1 to 13 and SEGOUT14 to 27

\*3 Output pins out of SEGOUT14 to 27

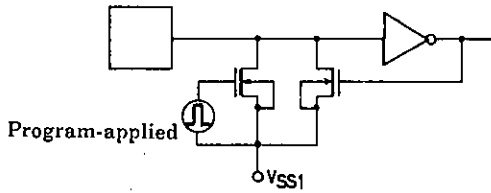

Fig. 1 Input configuration of S1-4, M1-4

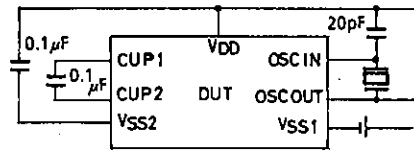

Fig. 2 Current dissipation, output voltage test circuit

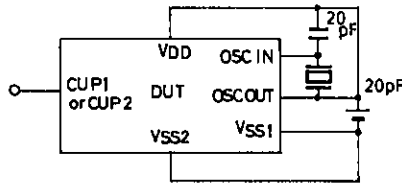

Fig. 3 Oscillation start voltage, oscillation start time, frequency stability, oscillation hold voltage test circuit

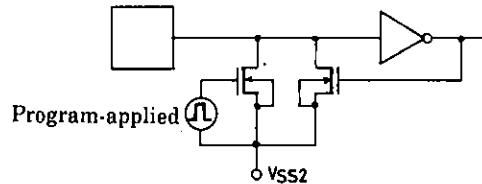

Fig. 4 Input configuration of S1-4, M1-4

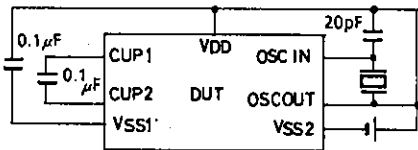

Fig. 5 Current dissipation, output voltage test circuit

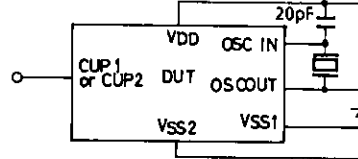

Fig. 6 Oscillation start voltage, oscillation start time, frequency stability, oscillation hold voltage test circuit

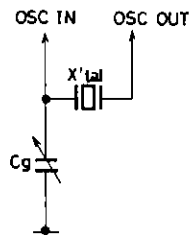

Fig. 7 Recommended crystal oscillation circuit

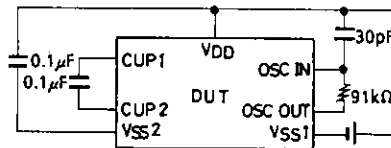

Fig. 8 Current dissipation, output voltage test circuit

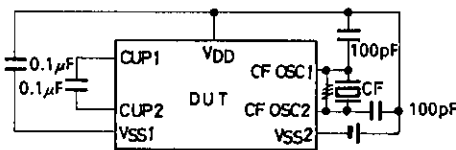

Fig. 9 Current dissipation, output voltage test circuit

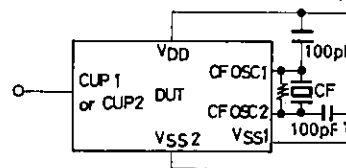

Fig. 10 Oscillation start voltage, oscillation start time, frequency stability, oscillation hold voltage test circuit

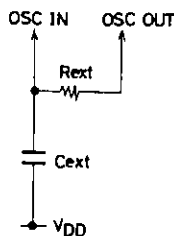

Fig. 11 Recommended CR oscillation circuit

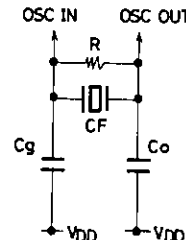

Fig. 12 Recommended ceramic resonator oscillation circuit