

SHARP®

AQUOS

LC-70LE600U LC-60LE600U



LIQUID CRYSTAL
TELEVISION

OPERATION MANUAL ENGLISH



NOM 1245



IMPORTANT : Please read this operation manual
before starting operating the equipment.

Supplied Accessories

Make sure the following accessories are provided with the product.



Remote control unit (× 1)
Page 9



"AA" size battery (× 2)
Page 10



Stand unit (× 1)
Page 7



Operation manual
(× 3 languages)

■ Connection guide (× 1)

NOTE

- Always use the AC cord supplied with the TV.
- The illustrations above are for explanation purposes and may vary slightly from the actual accessories.

- The illustrations and on-screen displays in this operation manual are for explanation purposes and may vary slightly from the actual operations.
- The examples used throughout this manual are based on the LC-60LE600U model.

IMPORTANT:

To aid reporting in case of loss or theft, please record the TV's model and serial numbers in the space provided. The numbers are located at the rear and right side of the TV.

Model No.:

Serial No.:

IMPORTANT INFORMATION

WARNING: TO REDUCE THE RISK OF FIRE OR ELECTRIC SHOCK, DO NOT EXPOSE THIS PRODUCT TO RAIN OR MOISTURE.



CAUTION: TO REDUCE THE RISK OF ELECTRIC SHOCK,
DO NOT REMOVE COVER (OR BACK).
NO USER-SERVICEABLE PARTS INSIDE.
REFER SERVICING TO QUALIFIED SERVICE
PERSONNEL.



The lightning flash with arrow-head symbol, within an equilateral triangle, is intended to alert the user to the presence of uninsulated "dangerous voltage" within the product's enclosure that may be of sufficient magnitude to constitute a risk of electric shock to persons.



The exclamation point within a triangle is intended to alert the user to the presence of important operating and maintenance (servicing) instructions in the literature accompanying the product.

CAUTION: TO PREVENT ELECTRIC SHOCK, MATCH WIDE BLADE OF PLUG TO WIDE SLOT, FULLY INSERT.

WARNING: FCC Regulations state that any unauthorized changes or modifications to this equipment not expressly approved by the manufacturer could void the user's authority to operate this equipment.

CAUTION: This product satisfies FCC regulations when shielded cables and connectors are used to connect the unit to other equipment. To prevent electromagnetic interference with electric appliances such as radios and televisions, use shielded cables and connectors for connections.

Printed in Mexico
TINS-F576WJZZ
12P07-MX-NM

IMPORTANT INFORMATION

DECLARATION OF CONFORMITY:

SHARP LIQUID CRYSTAL TELEVISION, MODEL LC-70LE600U/LC-60LE600U

This device complies with Part 15 of the FCC Rules. Operation is subject to the following two conditions:

(1) This device may not cause harmful interference, and (2) this device must accept any interference received, including interference that may cause undesired operation.

RESPONSIBLE PARTY:

SHARP ELECTRONICS CORPORATION

Sharp Plaza, Mahwah, New Jersey 07495-1163

TEL: 1-800-BE-SHARP

For Business Customers: URL <http://www.sharppusa.com>

INFORMATION:

This equipment has been tested and found to comply with the limits for a Class B digital device, pursuant to Part 15 of the FCC Rules. These limits are designed to provide reasonable protection against harmful interference in a residential installation. This equipment generates, uses and can radiate radio frequency energy and, if not installed and used in accordance with the instructions, may cause harmful interference to radio communications. However, there is no guarantee that interference will not occur in a particular installation. If this equipment does cause harmful interference to radio or television reception, which can be determined by turning the equipment off and on, the user is encouraged to try to correct the interference by one or more of the following measures:

- Reorient or relocate the receiving antenna.
- Increase the separation between the equipment and receiver.
- Connect the equipment into an outlet on a circuit different from that to which the receiver is connected.
- Consult the dealer or an experienced radio/TV technician for help.

"Note to CATV system installer: This reminder is provided to call the CATV system installer's attention to Article 820 of the National Electrical Code that provides guidelines for proper grounding and, in particular, specifies that the cable ground shall be connected to the grounding system of the building, as close to the point of cable entry as practical."

This product qualifies for ENERGY STAR when "Home" is selected for "TV Location".

Setting "TV Location" to "Home" allows the TV to achieve an energy-saving status for household use.

Trademarks

- Manufactured under license from Dolby Laboratories. Dolby and the double-D symbol are trademarks of Dolby Laboratories.
- The terms HDMI and HDMI High-Definition Multimedia Interface, and the HDMI Logo are trademarks or registered trademarks of HDMI Licensing LLC in the United States and other countries.
- Products that have earned the ENERGY STAR[®] are designed to protect the environment through superior energy efficiency.

DEAR SHARP CUSTOMER

Thank you for your purchase of the Sharp Liquid Crystal Television. To ensure safety and many years of trouble-free operation of your product, please read the Important Safety Instructions carefully before using this product.

IMPORTANT SAFETY INSTRUCTIONS

Electricity is used to perform many useful functions, but it can also cause personal injuries and property damage if improperly handled. This product has been engineered and manufactured with the highest priority on safety. However, improper use can result in electric shock and/or fire. In order to prevent potential danger, please observe the following instructions when installing, operating and cleaning the product. To ensure your safety and prolong the service life of your Liquid Crystal Television, please read the following precautions carefully before using the product.

- 1) Read these instructions.
- 2) Keep these instructions.
- 3) Heed all warnings.
- 4) Follow all instructions.
- 5) Do not use this apparatus near water.
- 6) Clean only with dry cloth.
- 7) Do not block any ventilation openings. Install in accordance with the manufacturer's instructions.
- 8) Do not install near any heat sources such as radiators, heat registers, stoves, or other apparatus (including amplifiers) that produce heat.
- 9) Do not defeat the safety purpose of the polarized or grounding-type plug. A polarized plug has two blades with one wider than the other. A grounding type plug has two blades and a third grounding prong. The wide blade or the third prong are provided for your safety. If the provided plug does not fit into your outlet, consult an electrician for replacement of the obsolete outlet.
- 10) Protect the power cord from being walked on or pinched particularly at plugs, convenience receptacles, and the point where they exit from the apparatus.
- 11) Only use attachments/accessories specified by the manufacturer.
- 12) Use only with the cart, stand, tripod, bracket, or table specified by the manufacturer, or sold with the apparatus. When a cart is used, use caution when moving the cart/apparatus combination to avoid injury from tip-over.
- 13) Unplug this apparatus during lightning storms or when unused for long periods of time.
- 14) Refer all servicing to qualified service personnel. Servicing is required when the apparatus has been damaged in any way, such as power-supply cord or plug is damaged, liquid has been spilled or objects have fallen into the apparatus, the apparatus has been exposed to rain or moisture, does not operate normally, or has been dropped.



Additional Safety Information

- 15) Power Sources—This product should be operated only from the type of power source indicated on the marking label. If you are not sure of the type of power supply to your home, consult your product dealer or local power company. For products intended to operate from battery power, or other sources, refer to the operating instructions.
- 16) Overloading—Do not overload wall outlets, extension cords, or integral convenience receptacles as this can result in a risk of fire or electric shock.
- 17) Object and Liquid Entry—Never push objects of any kind into this product through openings as they may touch dangerous voltage points or short-out parts that could result in a fire or electric shock. Never spill liquid of any kind on the product.
- 18) Damage Requiring Service—Unplug this product from the wall outlet and refer servicing to qualified service personnel under the following conditions:
 - a) When the AC cord or plug is damaged,
 - b) If liquid has been spilled, or objects have fallen into the product,
 - c) If the product has been exposed to rain or water,
 - d) If the product does not operate normally by following the operating instructions.
Adjust only those controls that are covered by the operating instructions as an improper adjustment of other controls may result in damage and will often require extensive work by a qualified technician to restore the product to its normal operation,
 - e) If the product has been dropped or damaged in any way, and
 - f) When the product exhibits a distinct change in performance - this indicates a need for service.
- 19) Replacement Parts—When replacement parts are required, be sure the service technician has used replacement parts specified by the manufacturer or have the same characteristics as the original part. Unauthorized substitutions may result in fire, electric shock, or other hazards.
- 20) Safety Check—Upon completion of any service or repairs to this product, ask the service technician to perform safety checks to determine that the product is in proper operating condition.
- 21) Wall or ceiling mounting—When mounting the product on a wall or ceiling, be sure to install the product according to the method recommended by the manufacturer.

IMPORTANT SAFETY INSTRUCTIONS

- **Outdoor Antenna Grounding** — If an outside antenna is connected to the television equipment, be sure the antenna system is grounded so as to provide some protection against voltage surges and built-up static charges. Article 810 of the National Electrical Code, ANSI/NFPA 70, provides information with regard to proper grounding of the mast and supporting structure, grounding of the lead-in wire to an antenna discharge unit, size of grounding conductors, location of antenna-discharge unit, connection to grounding electrodes, and requirements for the grounding electrode.

EXAMPLE OF ANTENNA GROUNDING AS PER NATIONAL ELECTRICAL CODE, ANSI/NFPA 70

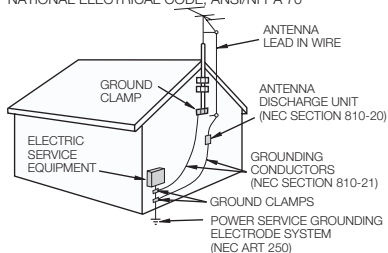

NEC — NATIONAL ELECTRICAL CODE

- **Water and Moisture** — Do not use this product near water - for example, near a bath tub, wash bowl, kitchen sink, or laundry tub; in a wet basement; or near a swimming pool; and the like.
- **Stand** — Do not place the product on an unstable cart, stand, tripod or table. Placing the product on an unstable base can cause the product to fall, resulting in serious personal injuries as well as damage to the product. Use only a cart, stand, tripod, bracket or table recommended by the manufacturer or sold with the product. When mounting the product on a wall, be sure to follow the manufacturer's instructions. Use only the mounting hardware recommended by the manufacturer.
- **Selecting the location** — Select a place with no direct sunlight and good ventilation.
- **Ventilation** — The vents and other openings in the cabinet are designed for ventilation. Do not cover or block these vents and openings since insufficient ventilation can cause overheating and/or shorten the life of the product. Do not place the product on a bed, sofa, rug or other similar surface, since they can block ventilation openings. This product is not designed for built-in installation; do not place the product in an enclosed place such as a bookcase or rack, unless proper ventilation is provided or the manufacturer's instructions are followed.
- **The Liquid Crystal panel used in this product is made of glass.** Therefore, it can break when the product is dropped or applied with impact. Be careful not to be injured by broken glass pieces in case the panel breaks.
- **Heat** — The product should be situated away from heat sources such as radiators, heat registers, stoves, or other products (including amplifiers) that produce heat.
- **The Liquid Crystal panel is a very high technology product with 2,073,600 pixels, giving you fine picture details.** Occasionally, a few non-active pixels may appear on the screen as a fixed point of blue, green or red. Please note that this does not affect the performance of your product.
- **Lightning** — For added protection for this television equipment during a lightning storm, or when it is left unattended and unused for long periods of time, unplug it from the wall outlet and disconnect the antenna. This will prevent damage to the equipment due to lightning and power-line surges.
- **Power Lines** — An outside antenna system should not be located in the vicinity of overhead power lines or other electric light or power circuits, or where it can fall into such power lines or circuits. When installing an outside antenna system, extreme care should be taken to keep from touching such power lines or circuits as contact with them might be fatal.
- To prevent fire, never place any type of candle or flames on the top or near the TV set.
- To prevent fire or shock hazard, do not place the AC cord under the TV set or other heavy items.
- Do not display a still picture for a long time, as this could cause an afterimage to remain.
- To prevent fire or shock hazard, do not expose this product to dripping or splashing. No objects filled with liquids, such as vases, should be placed on the product.
- Do not insert foreign objects into the product. Inserting objects in the air vents or other openings may result in fire or electric shock. Exercise special caution when using the product around children.



Precautions when transporting the TV

- When transporting the TV, never carry it by holding or otherwise putting pressure onto the display. Be sure to always carry the TV by two people holding it with two hands — one hand on each side of the TV.

Caring for the Cabinet

- Use a soft cloth (cotton, flannel, etc.) and gently wipe the surface of the cabinet.
 - Using a chemical cloth (wet/dry sheet type cloth, etc.) may deform the components of the main unit cabinet or cause cracking.
 - Wiping with a hard cloth or using strong force may scratch the surface of the cabinet.
 - If the cabinet is very dirty, wipe with a soft cloth (cotton, flannel, etc.) soaked in neutral detergent diluted with water and thoroughly wrung out, and then wipe with a soft dry cloth.
 - Avoid using benzene, thinner, and other solvents, as these may deform the cabinet and cause the paint to peel off.
 - Do not apply insecticides or other volatile liquids.
- Also, do not allow the cabinet to remain in contact with rubber or vinyl products for a long period of time. Plasticizers inside the plastic may cause the cabinet to deform and cause the paint to peel off.

IMPORTANT SAFETY INSTRUCTIONS

Caring for the Liquid Crystal panel

- Turn off the main power and unplug the AC cord from the wall outlet before handling.
- Gently wipe the surface of the display panel with a soft cloth (cotton, flannel, etc.). To protect the display panel, do not use a dirty cloth, liquid cleaners, or a chemical cloth (wet/dry sheet type cloth, etc.). This may damage the surface of the display panel.
- Wiping with a hard cloth or using strong force may scratch the surface of the display panel.
- Use a soft damp cloth to gently wipe the display panel when it is really dirty. (It may scratch the surface of the display panel when wiped strongly.)
- If the display panel is dusty, use an anti-static brush, which is commercially available, to clean it.
- To avoid scratching the frame or screen, please use a soft, lint free cloth for cleaning. Approved cleaning cloths are available directly from Sharp in single (00Z-LCD-CLOTH) or triple (00Z-LCD-CLOTH-3) packs. Call 1-800-BE-SHARP for ordering, or VISIT <http://www.sharpusa.com/SharpDirect>.



CHILD SAFETY:

It Makes A Difference How and Where You Use Your Flat Panel Display

Congratulations on your purchase! As you enjoy your new product, please keep these safety tips in mind:



THE ISSUE

- The home theater entertainment experience is a growing trend and larger flat panel displays are popular purchases. However, flat panel displays are not always supported on the proper stands or installed according to the manufacturer's recommendations.
- Flat panel displays that are inappropriately situated on dressers, bookcases, shelves, desks, speakers, chests or carts may fall over and cause injury.

THIS MANUFACTURER CARES!

- The consumer electronics industry is committed to making home entertainment enjoyable and safe.

TUNE INTO SAFETY

- One size does NOT fit all. Follow the manufacturer's recommendations for the safe installation and use of your flat panel display.
- Carefully read and understand all enclosed instructions for proper use of this product.
- Don't allow children to climb on or play with furniture and television sets.
- Don't place flat panel displays on furniture that can easily be used as steps, such as a chest of drawers.
- Remember that children can become excited while watching a program, especially on a "larger than life" flat panel display. Care should be taken to place or install the display where it cannot be pushed, pulled over, or knocked down.
- Care should be taken to route all cords and cables connected to the flat panel display so that they cannot be pulled or grabbed by curious children.



WALL MOUNTING: IF YOU DECIDE TO WALL MOUNT YOUR FLAT PANEL DISPLAY, ALWAYS:

- Use a mount that has been recommended by the display manufacturer and/or listed by an independent laboratory (such as UL, CSA, ETL).
- Follow all instructions supplied by the display and wall mount manufacturers.
- If you have any doubts about your ability to safely install your flat panel display, contact your retailer about professional installation.
- Make sure that the wall where you are mounting the display is appropriate. Some wall mounts are not designed to be mounted to walls with steel studs or old cinder block construction. If you are unsure, contact a professional installer.
- A minimum of two people are required for installation. Flat panel displays can be heavy.



Note: CEA is the preeminent trade association promoting growth in the \$161 billion U.S. consumer electronics industry. More than 2,200 companies enjoy the benefits of CEA membership, including legislative advocacy, market research, technical training and education, industry promotion and the fostering of business and strategic relationships.

QUICK REFERENCE

Attaching the Stand

- Before attaching the stand, make sure to turn off the TV and unplug the AC cord.
- Before performing work spread cushioning over the base area to lay the TV on. This will prevent it from being damaged.

CAUTION

- **Attach the stand in the correct direction.**
- **Do not remove the stand from the TV unless using an optional wall mount bracket to mount it.**
- **Be sure to follow the instructions. Incorrect installation of the stand may result in the TV falling over.**
- **After attaching the stand to the TV, do not hold the stand when you put up, set up, move or lay down the TV.**

- 1 Confirm that there are 12 screws (8 long screws and 4 short screws) supplied with the stand unit.



- 2
 - 1 Set the post for the stand unit onto the polystyrene foam.
 - 2 Attach the base to the post.
 - 3 Insert and tighten the 8 screws into the 8 holes on the bottom of the base.
 - Hold the stand unit securely with one hand, and then tighten the screws.

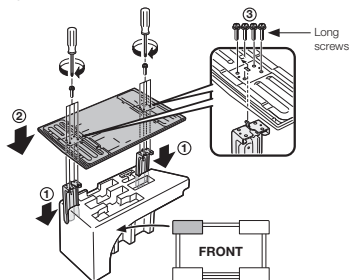

- 3
 - 1 Insert the stand into the openings on the bottom of the TV.
 - Make sure that the stand is firmly inserted into the TV. Improper installation may result in tilting of the TV set.
 - 2 Insert and tighten the 4 screws into the 4 holes on the rear of the TV.

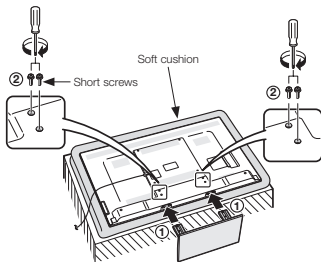

Removing the Stand

- Before detaching the stand, make sure to turn off the TV and unplug the AC cord.

CAUTION

- **Do not remove the stand from the TV unless using an optional wall mount bracket to mount it.**

- 1 Unfasten the four screws used to secure the stand in place.

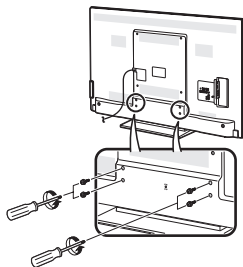

- 2 Detach the stand from the TV.

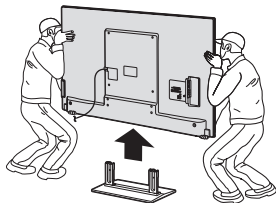

NOTE

- In the installation procedure, be careful not to catch your fingers between the TV set and the floor.

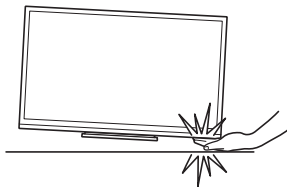

Setting the TV on the Wall

CAUTION

- This TV should be mounted on the wall only with the wall mount bracket AN-52AG4 (SHARP). The use of other wall mount brackets may result in an unstable installation and may cause serious injuries.
- Installing the TV requires special skill that should only be performed by qualified service personnel. Customers should not attempt to do the work themselves. SHARP bears no responsibility for improper mounting or mounting that results in accident or injury.

Using an optional bracket to mount the TV

- You can ask a qualified service professional about using an optional AN-52AG4 bracket to mount the TV to the wall.
- Carefully read the instructions that come with the bracket before beginning work.

Hanging on the wall

AN-52AG4 wall mount bracket.
(See the bracket instructions for details.)

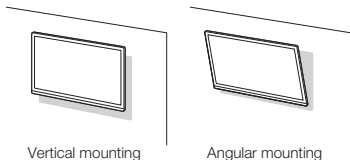

About setting the TV angle

AN-52AG4

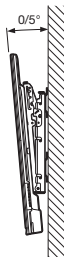

LC-70LE600U

- The center of the display: $\frac{25}{64}$ inch (10.0 mm) above the "c" position.

LC-60LE600U

- The "e" position is at the center of the display.
- Refer to the operation manual of AN-52AG4 for details.

NOTE

- Due to the terminal configuration on this TV, when you wall-mount this model, make sure there is enough space between the wall and the TV for the cables.
- To use this TV mounted on a wall, remove the AC cord holder on the rear of the TV, and then use the screws supplied with the wall mount bracket to secure the bracket to the rear of the TV.

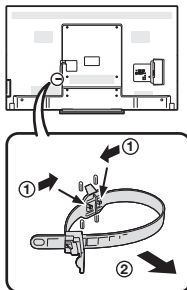

Optional Accessory

The listed optional accessory is available for the Liquid Crystal Television. Please purchase them at your nearest shop.

- Additional optional accessories may be available in the near future. When purchasing, please read the newest catalogue for compatibility and check the availability.

Part name	Model number
Wall mount bracket	AN-52AG4

QUICK REFERENCE

QUICK INSTALLATION TIPS

- 1 Attach your antenna to the back of the television. (See page 10.)
- 2 Connect the AC plug for the television into the AC outlet.

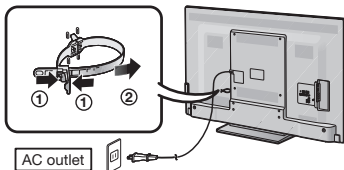

- Place the TV close to the AC outlet, and keep the power plug within reach.

NOTE

- **TO PREVENT RISK OF ELECTRIC SHOCK, DO NOT TOUCH UN-INSULATED PARTS OF ANY CABLES WITH THE AC CORD CONNECTED.**
- 3 When turning on the TV for the first time, press **POWER** on the television.

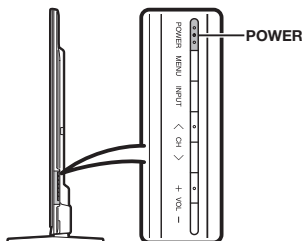

- 4 Insert the batteries into the remote control unit. (See page 10.)

NOTE

- Speakers cannot be detached from the TV.
- TV angle cannot be adjusted.

Experiencing HD images

An HDTV without an HD source is just an ordinary TV. To enjoy HD images on the TV, you should get HD programming from the following:

- Over-the-air broadcasting via HD quality antenna
- HD cable/satellite subscription
- HD compatible external equipment

NOTE

- For information on updating to HD programming, ask your cable/satellite service provider.

Using the Remote Control Unit

Use the remote control unit by pointing it towards the remote control sensor on the TV. Objects between the remote control unit and the remote control sensor may prevent proper operation.

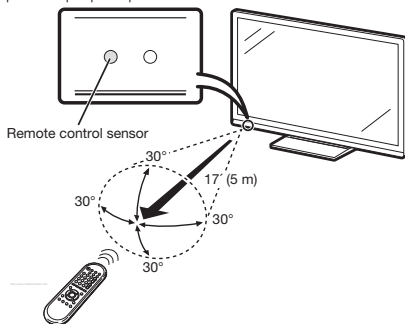

■ Cautions regarding the remote control unit

- Do not expose the remote control unit to shock. In addition, do not expose the remote control unit to liquids, and do not place in an area with high humidity.
- Do not install or place the remote control unit under direct sunlight. The heat may cause deformation of the remote control unit.
- The remote control unit may not work properly if the remote control sensor on the TV is under direct sunlight or strong lighting. In such cases, change the angle of the lighting or the TV, or operate the remote control unit closer to the remote control sensor.

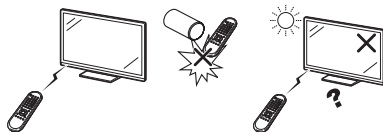

IMPORTANT:

IF THE UNIT DOES NOT POWER ON - UNPLUG THE TELEVISION FROM THE OUTLET AND REPEAT THE INSTALLATION STEPS.

IF YOU STILL ENCOUNTER NO POWER, PLEASE CONTACT US AT 1-800-BE-SHARP.

Preparation

Antennas

To enjoy a clearer picture, use an outdoor antenna. The following is a brief explanation of the types of connections that are used for a coaxial cable. If your outdoor antenna uses a 75-ohm coaxial cable with an F-type connector, plug it into the antenna terminal at the rear of the TV set.

1. A 75-ohm system is generally a round cable with F-type connector that can easily be attached to a terminal without tools (Commercially available).
2. A 300-ohm system is a flat "twin-lead" cable that can be attached to a 75-ohm terminal through a 300/75-ohm adapter (Commercially available).

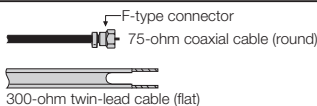

NOTICE F-type connector should be finger-tightened only.

When connecting the RF cable to the TV set, do not tighten F-type connector with tools.

If tools are used, it may cause damage to your TV set. (The breaking of internal circuit, etc.)

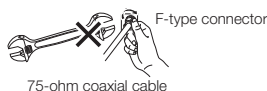

Connecting Antenna Cable

• Connect the antenna cable to the TV using one of the methods in the illustration as shown (①, ②, ③ or ④).

① Cable without a CATV converter

② VHF/UHF antenna

③ Combination VHF/UHF antenna

④ Separate VHF/UHF antenna

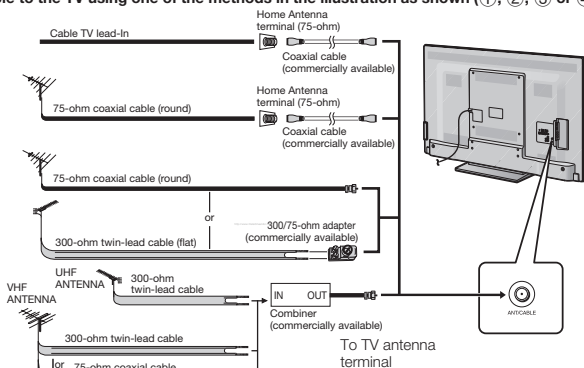

Installing Batteries in the Remote Control Unit

If the remote control fails to operate TV functions, replace the batteries in the remote control unit.

1 Open the battery cover.

2 Insert two "AA" size batteries (supplied with the product).

3 Close the battery cover.

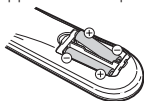
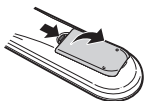

- Place the batteries with their terminals corresponding to the (+) and (-) indications in the battery compartment.

CAUTION

Improper use of batteries can result in chemical leakage or explosion. Be sure to follow the instructions below.

- Do not mix batteries of different types. Different types of batteries have different characteristics.
- Do not mix old and new batteries. Mixing old and new batteries can shorten the life of new batteries or cause chemical leakage in old batteries.
- Remove batteries as soon as they are worn out. Chemicals that leak from batteries that come in contact with skin can cause a rash. If you find any chemical leakage, wipe thoroughly with a cloth.
- The batteries supplied with this product may have a shorter life expectancy due to storage conditions.
- If you will not be using the remote control unit for an extended period of time, remove batteries from it.

Connecting to External Equipment







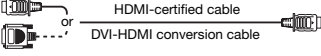

You can connect many types of external equipment to your TV. To view external source images, select the input source from **INPUT** on the remote control unit or on the TV. (See page 16.)

For connecting the TV to external equipment, use commercially available cables.

- The illustrations of the terminals are for explanation purposes and may vary slightly from the actual products.

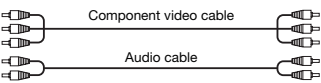
- CAUTION**
- To protect equipment, always turn off the TV before connecting any external equipment.
 - Please read the relevant operation manual (Blu-ray disc player, etc.) carefully before making connections.

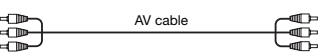
■ Connecting a Blu-ray Disc Player, DVD Player, Cable/Satellite Set-top Box, VCR, Game Console or Camcorder





Terminal on external equipment	Cable	Terminal on the TV
 <p>HDMI DVI OUT AUDIO</p>	 <p>HDMI-certified cable or DVI-HDMI conversion cable</p> <p>ø 3.5 mm stereo minijack cable</p>	<p>HDMI 1, 2 or 3</p>  <p>AUDIO</p> 
 <p>COMPONENT Y Pb Pr L R AUDIO</p>	 <p>Component video cable Audio cable</p>	<p>COMPONENT</p> 
 <p>VIDEO L R AUDIO</p>	 <p>AV cable</p>	<p>VIDEO</p> 

*1 Supported Audio format: Linear PCM, sampling rate 32/44, 1/48kHz.

*2 When using a DVI-HDMI conversion cable, you should make an analog audio connection. In this case, in addition to connecting a DVI-HDMI conversion cable to the HDMI 1 terminal, connect a ø 3.5 mm stereo minijack cable to the AUDIO input terminal and set "PC Audio Select" to "HDMI1". (See page 21.)

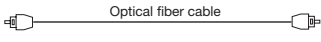
*3 To enjoy 1080p display capability, connect your external equipment using an HDMI-certified cable or a component cable and set the equipment to 1080p output.







■ Connecting an Audio Amplifier

Terminal on external equipment	Cable	Terminal on the TV
 <p>DIGITAL AUDIO INPUT</p>	 <p>Optical fiber cable</p>	<p>DIGITAL AUDIO OUTPUT</p> 
 <p>L R AUDIO INPUT</p>	 <p>Audio cable</p>	<p>OUTPUT</p> 

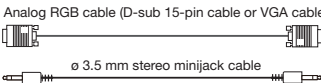
*4 The DIGITAL AUDIO OUTPUT terminal does not output some signals, depending on devices and software.

*5 See page 25 for details on the Output Select function.

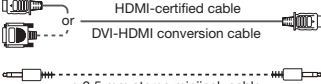
■ Connecting a PC

Terminal on PC	Cable	Terminal on the TV
 <p>ANALOG RGB AUDIO</p>	 <p>Analog RGB cable (D-sub 15-pin cable or VGA cable) ø 3.5 mm stereo minijack cable</p>	<p>PC IN</p>  <p>AUDIO</p> 
 <p>HDMI DVI OUT AUDIO</p>	 <p>HDMI-certified cable or DVI-HDMI conversion cable ø 3.5 mm stereo minijack cable</p>	<p>HDMI 1, 2 or 3</p>  <p>AUDIO</p> 

*6 When connecting a PC to the PC IN, set "PC Audio Select" to "PC IN". (See page 21.)

*7 Depending on the board, only video signals may be output. In this case, in addition to connecting an HDMI-certified cable to the HDMI 1 terminal, connect a ø 3.5 mm stereo minijack cable to the AUDIO input terminal and set "PC Audio Select" to "HDMI1". (See page 21.)

NOTE

- The HDMI terminals only support digital signal.
- Refer to page 28 for a list of PC signals compatible with the TV.

Watching TV

Turning On/Off the Power

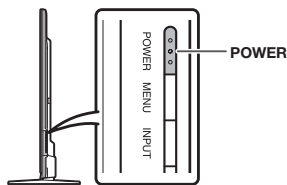

Press **POWER** on the TV or on the remote control unit to turn the power on.

NOTE

- The Initial Installation starts when the TV powers on for the first time. If the TV has been turned on before, the Initial Installation will not be invoked. For changing the settings of the Initial Installation, perform "EZ setup" on the Setup menu on page 21.

Press **POWER** on the TV or on the remote control unit again to turn the power off.

- The TV enters standby and the image on the screen disappears.

NOTE

- If you are not going to use this TV for a long period of time, be sure to remove the AC cord from the AC outlet.
- Weak electric power is still consumed even when the TV is turned off.

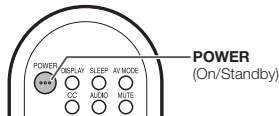

Initial Installation

When you turn on the TV for the first time, it will automatically memorize the broadcasting channels available in the region where you live. Perform the following steps before you press **POWER** on the remote control unit.

1. Insert the batteries into the remote control unit. (See page 10.)
2. Connect the antenna cable to the TV. (See page 10.)
3. Plug in the AC cord to the AC outlet. (See page 9.)

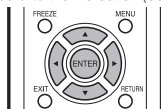

Language (Language setting)

Select from among 3 languages: English, French and Spanish.

- 1 Press **◀▶** to select the desired language listed on the screen, and then press **ENTER**.

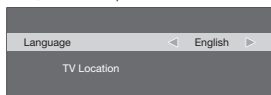

TV Location

Select "Home" or "Store" for the location where you plan to install the TV. This product qualifies for ENERGY STAR in Home mode default setting.

- 2 Press **◀▶** to select "Home" or "Store", and then press **ENTER**.

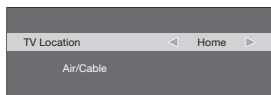

Home: AV Mode is set to "STANDARD".

Store: AV Mode is set to "DYNAMIC (Fixed)".

NOTE

- ENERGY STAR qualification is based on AV Mode "STANDARD".

Air/Cable (Antenna setting)

Make sure what kind of connection is made with your TV when selecting "Air" or "Cable".

- 3 Press **◀▶** to select "Air" or "Cable", and then press **ENTER**.

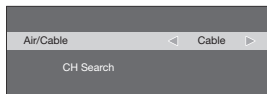

CH Search (Channel search)

Channel auto search makes the TV look for all channels viewable in the set area.

- 4 After "Air/Cable" has been set, the cursor moves to "CH Search".

Press **▶** or **ENTER** to start channel search.



NOTE

- If no channel is found, confirm the type of connection made with your TV and try "EZ Setup" again. (See page 21.)
- For changing the settings of the Initial Installation, perform "EZ setup" on the Setup menu on page 21.

Direct Button Operation

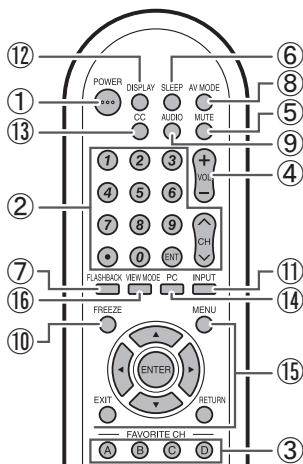

① POWER

You can turn on the TV or put it on standby by pressing **POWER** on the TV or on the remote control unit. (See page 13.)

② Changing Channels

You can change channels by pressing **CH**/ \wedge / \vee or **0-9**, • (DOT).

Examples:

To select a 1 or 2-digit channel number (e.g., Channel 5):
Press **5** → **ENT**.

To select a 3-digit channel number (e.g., Channel 115):
Press **1** → **1** → **5** → **ENT**.

To select a 4-digit channel number (e.g., Channel 22.1):
Press **2** → **2** → • (DOT) → **1** → **ENT**.

NOTE

- When selecting a 1-digit channel number, it is not necessary to press **0** before the number.
- When you enter **0-9** only, channel selection will be made if there is no operation within a few seconds.
- If you push "0" by itself, nothing will happen.
- Complete the above steps within a few seconds.
- When you enter **0-9** and • (DOT), channel selection will be made if there is no operation within a few seconds.

③ FAVORITE CH

You can select 4 preset favorite channels in 4 different categories.

Press **A, B, C** or **D**.

While watching the TV, you can toggle the selected channels by pressing **A, B, C** and **D**.

NOTE

- See page 25 for details of favorite channel settings.

④ Changing Volume

You can change the volume by pressing **VOL +/-** on the TV or on the remote control unit.

- To increase the volume, press **VOL +**.
- To decrease the volume, press **VOL -**.



Audio status

Output device	Output Select	
	Fixed	Variable
Speaker	Variable sound	Mute

- When "Output Select" is set to "Variable", the indicator on the screen changes as shown below.

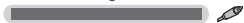

NOTE

- See page 25 for details on the Output Select function.

⑤ MUTE

Mutes the current sound output.

Press **MUTE**.

- "M" will be displayed on the screen for 40 seconds, and the sound is silenced. The Mute function will not be canceled even after the icon has disappeared.
- Press **MUTE** or **VOL +/-** to cancel the function.

NOTE

- When the Mute function is canceled, the volume returns to the previous level.

⑥ Sleep Timer

Allows you to set a time when the TV automatically switches to standby.

Press **SLEEP**.

- The remaining time displays when the sleep timer has been set.
- Each time you press **SLEEP**, the remaining time switches as shown below.

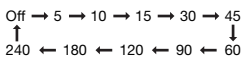

- When set, the time automatically starts counting down.
- If you want to adjust the sleep timer, you can press **SLEEP** twice then change the time setting.
- When it is 1 minute before the time expires, the remaining time will start to appear.

NOTE

- Select "Off" by pressing **SLEEP** to cancel the sleep timer.
- The TV will enter standby when the remaining time reaches 0.

⑦ FLASHBACK

Press **FLASHBACK** to switch to the previously tuned channel.

- Press **FLASHBACK** again to switch back to the currently tuned channel.

NOTE

- **FLASHBACK** will not work if no channel has been changed after the TV is turned on.
- This function is available only when the input source is TV.

Direct Button Operation

⑧ AV MODE

AV Mode gives you several viewing options to choose from to best match the surrounding environment of the TV, which can vary due to factors like room brightness, type of program watched or the type of device connected.

There are seven pre-set AV Modes: STANDARD, MOVIE, GAME, PC, USER, DYNAMIC and DYNAMIC (Fixed). You can use USER Mode to create customized settings for each TV input. These settings will be automatically saved on each input for convenience.

Press **AV MODE**. Current AV Mode displays.

- Press **AV MODE** again before the mode displayed on the screen disappears. The mode changes as shown below:

Example:

When using the VIDEO or COMPONENT terminals

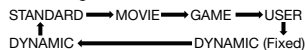

Example:

When using the HDMI terminals

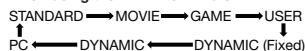

Example:

When using the PC IN terminal

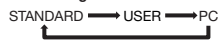

STANDARD: For a highly defined image in normal lighting.

MOVIE: For a movie.

GAME: Lowers image brightness for easier viewing.

PC: For PC.

USER: Allows the user to customize settings as described above.

DYNAMIC (Fixed): Changes the image and sound settings to the factory preset values. No adjustments are allowed.

DYNAMIC: For a clear-cut image emphasizing high contrast, useful for sports viewing.

NOTE

- You can select a different AV Mode for each input, allowing you to optimize your picture quality for different devices. (For example, select STANDARD for watching TV in a normal lighting environment.)
- If power is lost, USER Mode settings may need to be reset.

⑨ AUDIO

■ MTS/SAP stereo mode

The TV has a feature that allows reception of sound other than the main audio for the program. This feature is called Multi-channel Television Sound (MTS). The TV with MTS can receive mono sound, stereo sound and Secondary Audio Programs (SAP). The SAP feature allows a TV station to broadcast other information, which could be audio in another language or something completely different like weather information.

You can enjoy Hi-Fi stereo sound or SAP broadcasts where available.

- Stereo broadcasts:** View programs like live sporting events, shows and concerts in dynamic stereo sound.
- SAP broadcasts:** Receive TV broadcasts in either MAIN or SAP sound. MAIN sound: The normal program soundtrack (either in mono or stereo). SAP sound: Listen to a second language, supplementary commentary or other information. (SAP is mono sound.)

If stereo sound is difficult to hear.

- Obtain a clearer sound by manually switching to fixed mono-sound mode.

You can change MTS as shown below to match the television broadcast signal.

Press **AUDIO** to toggle between audio modes.

Examples: when receiving MTS and SAP

STEREO mode: STEREO ↔ MONO

STEREO + SAP mode: STEREO ↔ SAP → MONO

MONO mode: MONO

■ Digital broadcasting audio mode

The types of audio transmitted in a digital broadcast include SURROUND as well as MONO and STEREO. In addition, it is possible for multiple audio tracks to accompany a single video track.

- Press **AUDIO**.
 - A list of selectable audio is displayed.
- Press **▲/▼** to select audio.

NOTE

- MTS only operates while in TV mode.

Direct Button Operation

10 FREEZE

Allows you to capture and freeze a moving image that you are watching.

Press **FREEZE**.

- A moving image is captured.
- Press **FREEZE** again to cancel the function.

NOTE

- When this function is not available, "No displaying still image available." will display.
- The still image automatically goes out after 30 minutes.
- If you are using the freeze function and a broadcast activates the V-CHIP BLOCK, the freeze function will be canceled and a V-CHIP BLOCK message will appear.

11 INPUT

To view external source images, select the input source by pressing **INPUT** on the remote control unit or on the TV.

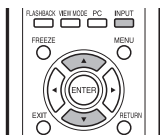

1 Press **INPUT**.

- A list of selectable sources appears.

2 Press **INPUT** again or press $\blacktriangle/\blacktriangledown$ to select the input source.

- Each time **INPUT** is pressed, the input source toggles.

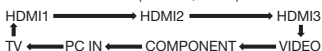

- An image from the selected source automatically displays.
- If the corresponding input is not plugged in, you cannot change the input. Be sure to connect the equipment beforehand.

NOTE

- See page 12 for external equipment connection.
- Press **PC** to switch to an image from the PC.

12 DISPLAY

Displays channel information being viewed.

Press **DISPLAY**.

13 Closed Captions and Digital Closed Captions

Your TV is equipped with an internal Closed Caption decoder. It allows you to view conversations, narration and sound effects as subtitles on your TV. Closed Captions are available on some TV programs and on some VHS home video tapes at the discretion of the program provider.

Digital Closed Caption service is a new caption service available only on digital TV programs (also at the discretion of the service provider). It is a more flexible system than the original Closed Caption system, because it allows for a variety of caption sizes and font styles. When the Digital Closed Caption service is in use, it will be indicated by the appearance of DTVCC.

Not all programs and VHS videotapes offer closed captions. Please look for the "**CC**" symbol to ensure that captions will be shown.

In the Closed Caption system, there can be more than one caption service provided. Each is identified by its own number. The "CC1", "CC2", "CC3" and "CC4" services display subtitles of TV programs superimposed over the program's picture.

In the Closed Caption system, the TEXT1, TEXT2, TEXT3 or TEXT4 services display text that is unrelated to the program being viewed (e.g., weather or news). These services are also superimposed over the program currently being viewed.

Press **CC**.

On: Displays the closed caption.

Off: Does not display the closed caption.

NOTE

- You can adjust the closed caption screen appearance to your preference. (See page 25.)

14 PC

Allows you to gain quick access to PC mode.

Press **PC**.

15 Operating On-Screen Display Menu

You can operate the on-screen display menu by using the following buttons.

MENU: Displays the menu screen.

$\blacktriangle/\blacktriangledown/\blackleftarrow/\blackrightarrow$, **ENTER:** Select a desired item on the screen.

RETURN: Returns to the previous menu screen.

EXIT: Turns off the menu screen.

NOTE

- For operating the on-screen display menu, see "Menu Operation Buttons" on page 18.





Direct Button Operation

VIEW MODE

You can select the screen size.

Press **VIEW MODE** to toggle between view modes.

■ For HD programs





Stretch	Dot by Dot (Full Screen)	Zoom	S.Stretch (Smart stretch)
 <p>Suitable for viewing wide-screen 1.78:1 aspect ratio program, stretch mode will still show very thin black bands at the top and bottom of the screen.</p>	 <p>Dot by Dot (1080i/p only): Detects the resolution of the signal and displays an image with the same number of pixels on the screen. Full Screen (720p only): You can select "Full Screen" only when receiving a 720p signal.</p>	 <p>Suitable for viewing wide-screen 2.35:1 aspect-ratio programs in full screen.</p>	 <p>Suitable for stretching 4:3 programs to fill the screen.</p>

NOTE

- When using Dot by Dot or Full Screen, it is possible to see noise or bars around different outer portions of the screen. Please change view mode to correct this.

■ For 4:3 programs

Example: Screen size images



Side Bar	S.Stretch (Smart stretch)	Zoom	Stretch
 <p>Suitable for viewing conventional 4:3 programs in their normal format.</p>	 <p>Suitable for stretching 4:3 programs to fill the screen.</p>	 <p>Suitable for viewing wide-screen 2.35:1 anamorphic DVDs in full screen.</p>	 <p>This mode is useful for 1.78:1 DVDs. When viewing 1.85:1 DVDs, stretch mode will still show very thin black bands at the top and bottom of the screen.</p>

■ For PC input mode

NOTE

- Connect the PC before making adjustments. (See page 12.)
- Selectable screen size may vary with input signal type.

Example: Screen size images

Normal	Stretch	Dot by Dot
 <p>Keeps the original aspect ratio in a full screen display.</p>	 <p>An image fully fills the screen.</p>	 <p>Detects the resolution of the signal and displays an image with the same number of pixels on the screen.</p>

On-Screen Display Menu

On-Screen Display Menu Operation

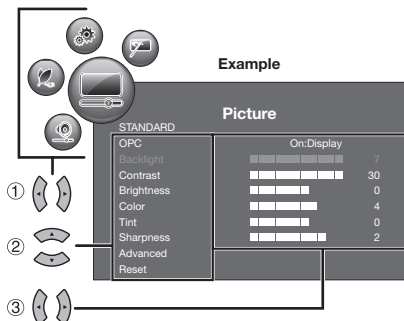

The bar above is an operational guide for the remote control. The icon of the button operated by the remote control will turn white.

- 1 Press **MENU** to display the MENU screen.
- 2 ① Press **◀/▶** to select the desired menu.
② Press **▲/▼** to select a specific adjustment item.
③ Press **◀/▶** (or **▲/▼**) to select or adjust the desired setting, and then press **ENTER**.
- 3 Press **MENU** to exit.

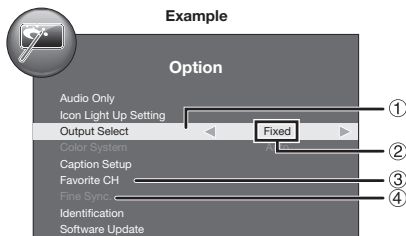

- ① Item displayed in light blue
 - This indicates the item currently selected.
- ② This indicates the current setting for the item.
- ③ Item displayed in white
 - This indicates that the item can be selected.
- ④ Item displayed in gray
 - This indicates that the item cannot be selected. There are various reasons why the items cannot be selected, but the main reasons are as follows:
 - Nothing is connected to the selected input terminal.
 - The function is not compatible with the current input signal.

NOTE

- Menu options differ in the selected input modes, but the operating procedures are the same.
- The screens in the operation manual are for explanation purposes (some are enlarged, others cropped) and may vary slightly from the actual screens.
- The order of explanations for each menu item in the following pages is not necessarily in accordance with the alignment of the items on the screen.

Menu Operation Buttons

Using the remote control

Use the following buttons on the remote control to operate the menu.

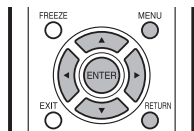

- MENU:** Press to open or close the menu screen.
- ▲/▼/◀/▶:** Press to select a desired item on the screen or adjust a selected item.
- ENTER:** Press to confirm the settings of Reset.
- RETURN:** Press to return to the previous step.

Using the control panel of the main unit

You can also operate the menu with the control panel of the main unit.

Button operations on the control panel correspond to the ones on the remote control as shown below.

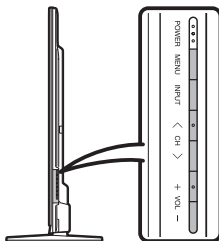

- MENU:** MENU on the remote control.
- INPUT:** ENTER on the remote control.
- CH ▲/▼:** Cursor ▲/▼ on the remote control.
- VOL +/–:** Cursor ◀/▶ on the remote control.

On-Screen Display Menu

Picture Menu

Adjusts the picture to your preference with the following picture settings.



Example

Picture	
STANDARD	
OPC	On:Display
Backlight	7
Contrast	30
Brightness	0
Color	4
Tint	0
Sharpness	2
Advanced	
Reset	

Selected item	◀button	▶button
Backlight	The screen dims	The screen brightens
Contrast	For less contrast	For more contrast
Brightness	For less brightness	For more brightness
Color	For less color intensity	For more color intensity
Tint	Skin tones become reddish	Skin tones become greenish
Sharpness	For less sharpness	For more sharpness

- For resetting all Picture adjustment items to the factory preset values, press ▲/▼ to select "Reset", press **ENTER**, press ◀▶ to select "Yes", and then press **ENTER**.

AV MODE

The current setting of AV Mode is displayed. (See page 15 for details of AV Mode settings.)

OPC Setting

Automatically adjusts the brightness of the screen.

On:Display: Displays the OPC effect on the screen while adjusting the brightness of the screen.

On: Automatically adjusts.

Off: The brightness is fixed at the value set in "Backlight".

NOTE

- When set to "On", the Optical Picture Control (OPC) senses the surrounding light and automatically adjusts the backlight brightness. Make sure nothing obstructs the OPC sensor, which could affect its ability to sense surrounding light.
- When set to "On:Display", OPC effect displays on the screen while the OPC adjusts the screen brightness.
- The OPC effect on the screen will not be displayed when "Closed Caption" is set to "On", even if you set "OPC" to "On:Display"

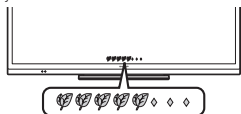

Advanced Picture Setting

This TV provides various advanced functions for optimizing the picture quality.

Color Temp. (Color Temperature)

For a better white balance, use color temperature correction.

High: White with bluish tone
Mid-High:
Middle: ↑↓
Mid-Low:
Low: White with reddish tone

Motion Enhancement

Use Motion Enhancement to view fast-action video more clearly.

On(High)/On(Low): For obtaining a clearer image.

Off: Normal image.

NOTE

- "Motion Enhancement" may cause image noise. If this occurs, turn the function "Off".
- When AV MODE is set to "GAME" or "PC", or PC format is being input, "Motion Enhancement" is not available.

Film Mode

This function provides high-quality playback of images originally encoded at 24 frames/second, such as films.

Advanced(High)/Advanced(Low): Select a desired level to remove jerkiness from film contents.

Standard: Detects, analyzes, converts film source.

Off: Normal viewing mode.

NOTE

- "Film Mode" does not function depending on input signal type.
- "Film Mode" does not function when you set AV MODE to "GAME" or "PC".
- "Standard" does not function depending on input signal type.

Active Contrast

Automatically adjusts the image contrast according to the scene.

On: Automatically adjusts the image contrast.

Off: No adjustment.

Digital Noise Reduction

Produces a clearer video image.

Off: No adjustment

High/Middle/Low: Select a desired level for viewing a clearer video image.

Range of OPC

The brightness level range of the OPC sensor's automatic adjustments can be set according to your preferences.

The adjustment range of the OPC sensor can be set to a maximum of 16 and a minimum of -16.

Max.: -15 through 16

Min.: -16 through 15

NOTE

- The maximum setting cannot be set to a smaller number than the minimum setting.
- The minimum setting cannot be set to a bigger number than the maximum setting.
- Depending on the brightness of the surrounding light, the OPC sensor might not operate if the adjustment range is small.

On-Screen Display Menu

Audio Menu

You can adjust the sound quality to your preference with the following settings.

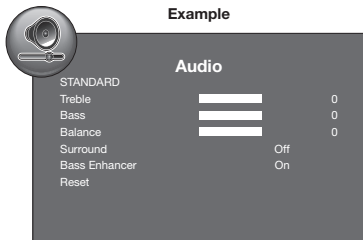

Selected item	◀button	▶button
Treble	For weaker treble	For stronger treble
Bass	For weaker bass	For stronger bass
Balance	Decrease audio from the right speaker	Decrease audio from the left speaker

NOTE

- Audio menu is grayed out when "Output Select" is set to "Variable". (See page 25.)
- For resetting all Audio adjustment items to the factory preset values, press ▲/▼ to select "Reset", press **ENTER**, press ◀▶ to select "Yes", and then press **ENTER**.

AV MODE

The current setting of AV Mode is displayed. (See page 15 for details of AV Mode settings.)

Surround

The surround function produces Surround effect from the speakers.

On: Makes it possible to enjoy natural, realistic surround sound.

Off: Outputs the normal sound.

NOTE

- Audio menu is grayed out when "Output Select" is set to "Variable". (See page 25.)
- For some discs, setup may be required on your BD/DVD player. In this case, please refer to the operation manual of your BD/DVD player.

Bass Enhancer

This function allows you to enjoy bass-enhanced sound.

On: Bass Enhancer function is on.

Off: Normal sound.

NOTE

- Audio menu is grayed out when "Output Select" is set to "Variable". (See page 25.)

Power Control Menu

Power control setting allows you to save energy.

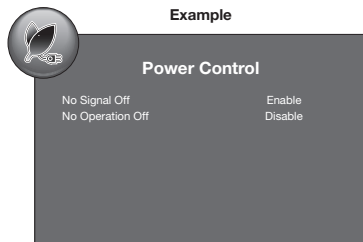

No Signal Off

This function allows the TV to automatically shut the power down when there is no signal received.

Enable: The power will automatically shut down if there is no signal for 15 minutes.

Disable: This function does not work.

NOTE

- When it is 1 minute before the power shuts down, the remaining time will start to appear.
- When a TV program finishes, this function may not operate.

No Operation Off

You can set the time length the TV takes to automatically shut the power down when there is no operation.

30 mins/3 hours/Disable

NOTE

- When it is 1 minute before the power shuts down, the remaining time will start to appear.

On-Screen Display Menu

Setup Menu



Example

Setup	
EZ Setup	
CH Setup	
Input Label	
Parental CTRL	
PC Audio Select	HDMI1
HDMI Auto View	Disable
Audio Setup	PCM
Language	English
Reset	

EZ Setup

You can run EZ Setup again, even after setting up the preset channels.

Language: Select from among 3 languages (English, French and Spanish).

TV Location: Select "Home" or "Store" for the location where you plan to install the TV. This product qualifies for ENERGY STAR in Home mode default setting.

Home: AV Mode is set to "STANDARD".

Store: AV Mode is set to "DYNAMIC (Fixed)".

- ENERGY STAR qualification is based on AV Mode "STANDARD".

Air/Cable: Make sure what kind of connection is made with your TV when selecting "Air" or "Cable".

CH Search: Channel auto search makes the TV look for all channels viewable in the set area.

NOTE

- See Initial Installation on page 13 for setting each item.
- If no channel is found, confirm the type of connection made with your TV and try "EZ Setup" again.

CH Setup

If Initial Installation does not memorize all the channels in your region, follow the instructions below to manually memorize the channels.

Air/Cable: Make sure what kind of connection is made with your TV when selecting "Air" or "Cable".

CH Search: Channel auto search makes the TV look for all channels viewable in the set area.

CH Memory: You can select the channels to skip.

Show/Hide: Removes the checkmarks to let the channels be skipped.

Signal Strength: The signal strength of DIGITAL channel is displayed. The signal information is based on the current channel.

NOTE

- See Initial Installation on page 13 for setting each item.
- If no channel is found, confirm the type of connection made with your TV and try channel search again.

Input Label

Lets you set the input terminal displayed when using the INPUT SOURCE menu or channel display. Press ◀▶ to select the new name for the input mode.

■ Setting the Names to Your Preference

- Press ◀▶ to select "Custom".
- Press ▲▼ to enter the desired characters.
 - You can use alphanumeric characters (including spaces or some symbols) to set the name to your preference.

NOTE

- If you press ▼ when "Default" is selected, the "Custom" setting display appears.

PC Audio Select

Determines whether the AUDIO input terminal is used for PC IN or HDMI 1.

HDMI1: Select this item when the audio signal is input via the HDMI 1 terminal using a DVI-HDMI conversion cable.

PC IN: Select this item when the audio signal is input via the PC IN terminal using an analog RGB cable (D-sub 15-pin cable or VGA cable).

NOTE

- When "PC Audio Select" is set to "HDMI1", sound will not be produced if you use only an HDMI-certified cable to connect HDMI-compatible equipment. To produce sound, you should make an analog audio connection.
- If you want to connect HDMI-compatible equipment using only an HDMI-certified cable, set "PC Audio Select" to "PC IN".

HDMI Auto View

To watch an HDMI or PC-IN equipment image, select "HDMI1", "HDMI2" or "HDMI3" from the INPUT SOURCE menu using **INPUT** on the remote control unit or on the TV.

Enable: To use View Mode based on signal recognition, including an HDMI signal.

Disable: No function.

NOTE

- Refer to your external equipment operation manual for the signal type.
- When connecting a DVI-HDMI conversion adapter/cable to the HDMI terminal, the image may not come in clearly.

Audio Setup

You can output digital audio to an AV amplifier or similar device whose DIGITAL AUDIO INPUT terminal is connected to the DIGITAL AUDIO OUTPUT terminal on the TV. Please select an audio output format compatible with the audio format of the program you are watching and the equipment connected.

PCM: The optical output terminal outputs audio signal in PCM form. If your digital audio system does not support Dolby Digital, select "PCM".

Dolby Digital: The optical output terminal outputs audio signal in Dolby Digital form. It reproduces sound from surround program of digital.

On-Screen Display Menu

Language

You can also select a language from the Setup menu. Select from among 3 languages: English, French and Spanish.

Reset

If complex adjustments are made and the settings cannot be restored to normal, you can reset the settings to the factory preset values.

Select "Yes".

- After the reset has been completed, the power shuts off and then comes back on. The screen will have returned to its original settings.

NOTE

- The Channel Setup settings will not be changed.
- The Language settings will not be changed.
- The Parental CTRL settings will not be changed.
- The TV Location settings will not be changed.

Parental CTRL (Parental Control Setting)

Secret No.

Allows you to use a secret number to protect certain settings from being accidentally changed.

IMPORTANT:

Three conditions must be met to enable the V-Chip (see pages 22 to 24):

1. Secret No. is registered.
2. V-Chip/V-Chip (DTV Only) settings have been made.
 - The "V-Chip (DTV Only)" will only be selectable when a new rating system can be downloaded via digital broadcasting in the U.S.
3. "Status" is set to "On".

■ New Secret No.

You can set and change the secret number by using 0-9.

Input Secret No.: When you change the secret number, enter the old 4-digit secret number here. The cursor moves to "New Secret No."

New Secret No.: When you set the new secret number, enter the new 4-digit secret number here. The cursor moves to "Reconfirm".

Reconfirm: Enter the same 4-digit number you set in "New Secret No."

■ Secret No. Clear

You can clear your secret number.

Yes: Your secret number is cleared.

No: Your secret number is not cleared.

NOTE

- As a precautionary measure, make a note of your secret number and keep it in a familiar place.
- If the secret number is cleared, the Status setting automatically sets to "Off". "V-Chip" and "Status" will not be selectable from the menu.

Status

Used to enable or disable the parental control function. This function will not be selectable from the menu if you do not first configure your secret number.

On: Enables Parental CTRL.

Off: Disables Parental CTRL.

V-Chip

V-CHIP is an electronic filtering device built into your TV. This tool gives parents a great degree of control over broadcasts accessed by their children. It allows parents to select programs judged suitable for child viewing while blocking ones judged not suitable. It does so automatically once you activate the V-CHIP feature in your TV. "V-Chip" and "Status" will not be selectable from the menu if you do not first configure your secret number.

- 1 Press **▲/▼** to select the desired rating system, and then press **▶** or **ENTER**.

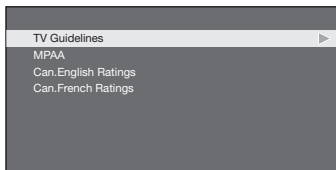

- 2 Press **▲/▼** to adjust the item to your desired position.

- "Block" indicates the item is blocked.

- 3 Press **MENU** to exit.

- The U.S. has two rating systems for viewing content: TV Parental Guidelines and movie ratings.
- The TV Parental Guidelines work in conjunction with the V-CHIP to help parents screen out inappropriate television shows from their children.
- Movie ratings are used for original movies rated by the Motion Picture Association of America (MPAA) as watched on cable TV and not edited for television. The V-CHIP can also be set to block MPAA-rated movies.

NOTE

- The setting automatically enters "Block" for any ratings below your selection.
- If Status is not set to "On", the configuration settings will not work.

On-Screen Display Menu

TV Parental Guidelines

Example

TV-Y		D	Block
TV-Y7		L	Block
TV-G		S	Block
TV-PG	Block	V	Block
TV-14	Block	FV	
TV-MA	Block		
NONE			

Example

TV-Y		D	Block
TV-Y7	Block	L	Block
TV-G	Block	S	Block
TV-PG	Block	V	Block
TV-14	Block	FV	Block
TV-MA	Block		
NONE			

Press ▲/▼ to adjust the item to your desired position.
"Block" indicates the item is blocked. Press **MENU** to exit.

When setting an individual content-based rating item:

- 1 Press ► or **ENTER** to access blocked content items from the currently selected age-based rating item.
- 2 Press ▲/▼ to select an individual item, and then press **ENTER** to unblock it ("Block" is removed). Repeat the same steps for the other items.
- 3 Press ◀ or **RETURN** to register after all individual content rating items are set.

Rating		Content				
		FV (Fantasy violence)	V (Violence)	S (Sexual situation)	L (Adult language)	D (Sexually suggestive dialog)
Suggested age	TV-Y (All children)	<input checked="" type="checkbox"/>	<input checked="" type="checkbox"/>	<input checked="" type="checkbox"/>	<input checked="" type="checkbox"/>	<input checked="" type="checkbox"/>
	TV-Y7 (Directed to older children)	<input type="checkbox"/>	<input checked="" type="checkbox"/>	<input checked="" type="checkbox"/>	<input checked="" type="checkbox"/>	<input checked="" type="checkbox"/>
	TV-G (General audience)		<input checked="" type="checkbox"/>	<input checked="" type="checkbox"/>	<input checked="" type="checkbox"/>	<input checked="" type="checkbox"/>
	TV-PG (Parental Guidance suggested)		<input type="checkbox"/>	<input type="checkbox"/>	<input type="checkbox"/>	<input type="checkbox"/>
	TV-14 (Parents strongly cautioned)		<input type="checkbox"/>	<input type="checkbox"/>	<input type="checkbox"/>	<input type="checkbox"/>
	TV-MA (Mature audience only)		<input type="checkbox"/>	<input type="checkbox"/>	<input type="checkbox"/>	

: The content rating can be set, but this rating is not normally broadcast by TV stations.

: Content rating can be set.

MPAA (Voluntary movie rating system)

Example

G	
PG	
PG-13	Block
R	Block
NC-17	Block
X	Block
NONE	

G: General audiences. All ages admitted.

PG: Parental guidance suggested. Some material may not be suitable for children.

PG-13: Parents strongly cautioned. Some material may be inappropriate for children under 13.

R: Restricted. Under 17 requires accompanying parent or adult guardian (age varies in some jurisdictions).

NC-17: No one 17 and under admitted.

X: X is an older rating that is unified with NC-17 but may be encoded in the data of older movies.

NOTE

- Voluntary movie rating system only uses an age-based rating.

On-Screen Display Menu

Canadian Rating Systems (Canadian English ratings and Canadian French ratings)

- The TV rating systems in Canada are based on the Canadian Radio-Television and Telecommunications Commission (CRTC) policy on violence in television programming.
- While violence is the most important content element to be rated, the structure developed takes into consideration other program content like language, nudity, sexuality and mature themes.
- When setting the V-CHIP on the Canadian system you can choose either the Canadian English ratings or the Canadian French ratings.

■ Canadian English Ratings

Example

C	
C8+	
G	Block
PG	Block
14+	Block
18+	Block
E	

C: Children: Intended for younger children under the age of 8 years.

Pays careful attention to themes that could threaten their sense of security and well-being.

C8+: Children over 8 years old: Contains no portrayal of violence as the preferred, acceptable, or only way to resolve conflict; nor encourage children to imitate dangerous acts which they may see on the screen.

G: General: Considered acceptable for all age groups. Appropriate viewing for the entire family, contains very little violence, physical, verbal or emotional.

PG: Parental Guidance: Intended for a general audience, but may not be suitable for younger children (under the age of 8) because it could contain controversial themes or issues.

14+: Over 14 years: Could contain themes where violence is one of the dominant elements of the storyline, but it must be integral to the development of plot or character. Language usage could be profane and nudity present within the context of the theme.

18+: Adults: Intended for viewers 18 years and older and might contain depictions of violence, which while related to the development of plot, character or themes, are intended for adult viewing. Could contain graphic language and portrayals of sex and nudity.

E: Exempt programming.

■ Canadian French Ratings

Example

G	
8ans+	
13ans+	Block
16ans+	Block
18ans+	Block
E	

G: General: All ages and children, contains minimal direct violence, but may be integrated into the plot in a humorous or unrealistic manner.

8ans+: General but inadvisable for young children: May be viewed by a wide public audience, but could contain scenes disturbing to children under 8 who cannot distinguish between imaginary and real situations.

Recommended for viewing with parent.

13ans+: Over 13 years: Could contain scenes of frequent violent scenes and therefore recommended for viewing with parent.

16ans+: Over 16 years: Could contain frequent violent scenes and intense violence.

18ans+: Over 18 years: Only for adult viewing. Could contain frequent violent scenes and extreme violence.

E: Exempt programming.

■ How to temporarily release the V-CHIP BLOCK

When the V-CHIP BLOCK is working and censors a broadcast, the message "V-CHIP HAS BEEN ACTIVATED." appears and the secret number setting box will be displayed under the message.

- Enter the 4-digit secret number by using **0-9**. Now V-CHIP BLOCK is temporarily released.

■ Reactivating the temporarily released V-CHIP BLOCK

You can reactivate the temporarily released V-CHIP BLOCK as shown below.

- Select "Status" setting from the Parental CTRL menu to reactivate BLOCK. (See page 22.)
- Select "V-Chip" setting ("TV Guidelines", "MPAA", "Can. English Ratings" or "Can. French Ratings") from the Parental CTRL to reactivate BLOCK. (See pages 22 to 24.)
- Switch off the TV power.

NOTE

- Performing any of the three above will activate the V-CHIP BLOCK.

On-Screen Display Menu

Option Menu



Example

Option	
Audio Only	
Icon Light Up Setting	
Output Select	Fixed
Color System	Auto
Caption Setup	
Favorite CH	
Fine Sync.	
Identification	
Software Update	

Audio Only

When listening to music from a music program, you can turn the screen off and enjoy audio only.

On: Audio is output without screen image.

Off: Both screen images and audio are output.

NOTE

- The screen image will return to normal when a button (except those for audio adjustment, such as **VOL**, **MUTE**) is pressed.

Icon Light Up Setting

When this function is set to "On", the LED on the front of the TV turns on.

If you select "Off" for the function, the confirmation screen appears. Selecting "Yes" on the screen will turn the LED off.

NOTE

- "On" is the factory preset value.

Output Select

Allows you to select what controls the audio output.

Fixed: Sound via speaker is adjusted with **VOL +/-** on the remote control unit or on the TV.

Sound via the OUTPUT terminal is not adjustable and outputs at a consistent level.

Variable: Sound via the OUTPUT terminal is adjusted with **VOL +/-** on the remote control unit or on the TV. Sound via speaker is muted.

Color System

Select the video signal system compatible with your equipment from the list below:

Auto/NTSC 3.58/PAL-M/PAL-N

NOTE

- "Color System" can only be set for the VIDEO.

Caption Setup

Closed Caption

You can switch the Closed Caption modes.

On: Displays the closed caption.

Off: Does not display the closed caption.

Basic Selection

You can select a desired Closed Caption.

Off/CC1-CC4/TEXT1-TEXT4

Advanced Selection

You can select a desired service.

Off/Service1-Service6

Setting

Mode

Default: The default settings will be displayed.

Custom: You can adjust the closed caption screen appearance to suit your preference. The following items can be adjusted.

**Font Style/Font Size/Font Edge/Edge Color/
Font Color/Background Color/Font Opacity/
Background Opacity**

Favorite CH

(Favorite Channel Setting)

This function allows you to program 4 favorite channels, in 4 different categories. By setting the favorite channels in advance, you can select your favorite channels easily.

To register your favorite channel:

Select "Register" and then press **ENTER**. Press **▲/▼/◀/▶** to select the position in the category, and then press **ENTER** to register.

To delete your favorite channel:

Select "1 Data Clear" and then press **ENTER**. Press **▲/▼/◀/▶** to select the channel you want to delete, and then press **ENTER**. Select "Yes" and then press **ENTER**. To delete all the favorite channels, select "All Data Clear".

NOTE

- Before setting the channel, select the channel you want to register as a favorite channel.

Fine Sync.

Ordinarily you can easily adjust the picture as necessary to change image position using "Auto Sync.". In some cases, however, manual adjustment is needed to optimize the image.

Selected item	Description
H-Position	Centers the image by moving it to the left or right.
V-Position	Centers the image by moving it up or down.
Clock	Adjust when the image flickers with vertical stripes.
Phase	Adjust when characters have low contrast or when the image flickers.

NOTE

- For resetting all "Fine Sync." adjustment items to the factory preset values, press **▲/▼** to select "Reset", press **ENTER**, press **◀/▶** to select "Yes", and then press **ENTER**.
- It is not necessary to adjust the "Clock" or "Phase" when a digital signal is being input, so it cannot be selected.
- The default cursor position may not be in the center, because the screen position variable ranges may be asymmetrical.

On-Screen Display Menu

Input Signal (for Analog PC Input Mode Only)

Some input signals may have to be registered manually to display properly. The pair of input signals (resolutions) in the list below is not distinguishable when received. In such a case, you have to set the correct signal manually. After setting once, it will display when the same signal (resolution) is input again.

1024 x 768 1360 x 768

NOTE

- You can only select the "Input Signal" on the Option menu when receiving one of the 2 input signals listed above.

Auto Sync. (for Analog PC Input Mode Only)

For automatically adjusting the PC image.

Yes: Auto Sync. starts.

No: This function does not work.

NOTE

- "Auto Sync." may fail if the computer image has low resolution, has unclear (black) edges, or is moved while executing "Auto Sync."
- Be sure to connect the PC to the TV and switch it on before starting "Auto Sync."

Identification

The current version of the TV software is displayed.

Software Update

This function allows software updates by inserting a USB memory device with the update file into the SERVICE terminal on the TV.

To check for the availability of a software update, visit <http://www.sharppusa.com/products/support/>. If you have any questions, please call 1-800-BE-SHARP (800-237-4277).

CAUTION

- Do not remove the USB memory device or unplug the AC cord while the software is being updated.**
- Be sure to properly follow the whole procedure described below, step by step. Otherwise, for example, the TV cannot read the data in the USB memory device and software updating will fail.**

- Insert the USB memory device with the update file into the SERVICE terminal on the TV.

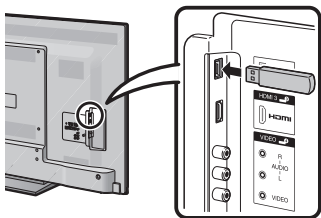

- Press **MENU** to display the MENU screen, and then press **◀▶** to select "Option".

- Press **▲▼** to select "Software Update", and then press **▶** or **ENTER**.



Example



- Press **◀▶** to select "Yes", and then press **ENTER** to start updating.

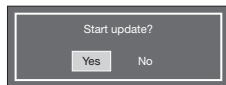

Example

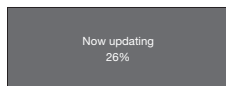

CAUTION

- Do not remove the USB memory device or unplug the AC cord while the software is being updated.**

- When the software is successfully updated, a screen is displayed indicating that the update process is completed. A few seconds later, the TV restarts automatically.

Example

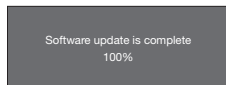

- When the software is being updated: The LED on the TV blinks.
 - When the software update is completed: The LED on the TV blinks faster.
 - If the update has failed, check the file in the USB memory device, reinsert the USB memory device correctly, and then try Software Update again.
- Remove the USB memory device after the TV has restarted.

Appendix

Troubleshooting

Problem	Possible Solution
<ul style="list-style-type: none"> No power 	<ul style="list-style-type: none"> Check if you pressed POWER on the remote control unit. ➔ Page 13 If the indicator on the TV does not light up, press POWER on the TV. Is the AC cord disconnected? ➔ Page 9 Has the power been turned on? ➔ Page 13
<ul style="list-style-type: none"> Unit cannot be operated. 	<ul style="list-style-type: none"> External influences such as lightning, static electricity, may cause improper operation. In this case, operate the unit after first turning off the power of the TV or unplugging the AC cord and replugging it in after 1 or 2 minutes.
<ul style="list-style-type: none"> Remote control unit does not operate. 	<ul style="list-style-type: none"> Are batteries inserted with polarity (+, -) aligned? ➔ Page 10 Are batteries worn out? (Replace with new batteries.) Are you using it under strong or fluorescent lighting? Is a fluorescent light illuminated near the remote control sensor?
<ul style="list-style-type: none"> Picture is cut off/with sidebar screen. 	<ul style="list-style-type: none"> Is the image position correct? ➔ Pages 25 and 26 Are screen mode adjustments such as picture size made correctly? ➔ Page 17
<ul style="list-style-type: none"> Strange color, light color, or color misalignment 	<ul style="list-style-type: none"> Adjust the picture tone. ➔ Page 19 Is the room too bright? The picture may look dark in a room that is too bright.
<ul style="list-style-type: none"> Power is suddenly turned off. 	<ul style="list-style-type: none"> Is the sleep timer set? ➔ Page 14 Check the power control settings. ➔ Page 20 The unit's internal temperature has increased. Remove any objects blocking vent or clean.
<ul style="list-style-type: none"> No sound 	<ul style="list-style-type: none"> Is connection to other components correct? ➔ Page 12 Is the volume too low? ➔ Page 14 Is "Variable" selected in "Output Select"? ➔ Page 25 Have you pressed MUTE on the remote control unit? ➔ Page 14 Check the audio output of the connected external equipment. Is the volume too low or muted? When external equipment is connected via an HDMI cable, you may need to configure the audio to be output through the HDMI cable. When audio is not output from external equipment connected to the PC IN or HDMI 1 terminal, check the "PC Audio Select" setting. ➔ Page 21 Even when external equipment is connected using an HDMI-certified cable, an audio cable connection may be required depending on the type of equipment and the media being played back. In this case, in addition to connecting an HDMI-certified cable to the HDMI 1 terminal, connect a ø 3.5 mm stereo minijack cable to the AUDIO input terminal and set "PC Audio Select" to "HDMI1". ➔ Page 21 When connecting a PC via an HDMI-certified cable, check the following: <ul style="list-style-type: none"> Is the audio output of the PC configured correctly? Check the audio output settings and output audio format in Sound Properties on the PC. Only PCM format audio can be output. Compressed audio (with a sampling rate of 32kHz, 44.1kHz, or 48kHz) and DTS format audio cannot be output. Depending on the board, only video signals may be output. In this case, in addition to connecting an HDMI-certified cable to the HDMI 1 terminal, connect a ø 3.5 mm stereo minijack cable to the AUDIO input terminal and set "PC Audio Select" to "HDMI1". ➔ Page 21 If you are using a DVI-HDMI conversion cable to connect external equipment to the TV, check the following: <ul style="list-style-type: none"> Is an audio cable connected? The DVI-HDMI conversion cable is for video only. Connect a ø 3.5 mm stereo minijack cable to listen to the audio. Is HDMI 1 being used? When the TV is connected to another HDMI terminal, the audio and video are not output together even if a ø 3.5 mm stereo minijack cable is connected to the shared AUDIO input terminal for PC IN and HDMI 1. Is "PC IN" selected in "PC Audio Select"? ➔ Page 21

Appendix

Problem	Possible Solution
<ul style="list-style-type: none"> No picture 	<ul style="list-style-type: none"> Is connection to other components correct? ➔ Page 12 Is the correct input selected? ➔ Page 16 Is "On" selected in "Audio Only"? ➔ Page 25 If the PC image is not displayed, check the following: <ul style="list-style-type: none"> When connecting a laptop PC to the TV, check that display output mode of the PC is set to external monitor. Check the resolution setting on the PC. Is a non-compatible signal being input? ➔ "PC Compatibility Chart" below
<ul style="list-style-type: none"> Picture quality of HD programs is poor. 	<ul style="list-style-type: none"> To enjoy HD images from external equipment, you are required to set up HDMI connection or component connection. If the program content is not of HD quality, HD images cannot be displayed. Check that the program you are viewing provides HD images. The HD cable/satellite set-top box may need to be configured to output HD images via cable/satellite. The cable/satellite broadcast may not support a signal resolution of 1080p.
<ul style="list-style-type: none"> The TV sometimes makes a cracking sound. 	<ul style="list-style-type: none"> This is not a malfunction. This happens when the cabinet slightly expands and contracts according to change in temperature. This does not affect the TV's performance.

Troubleshooting - Error Message

The example of an error message displayed on a screen	Possible Solution
<ul style="list-style-type: none"> Failed to receive broadcast. 	<ul style="list-style-type: none"> Check the antenna cable. Check that the antenna is correctly setup.

PC Compatibility Chart

It is necessary to set the PC correctly to display XGA and WXGA signal.

PC	Resolution	Horizontal Frequency	Vertical Frequency	VESA Standard	
PC	VGA	720 x 400	31.5 kHz	70 Hz	—
		640 x 480	31.5 kHz	60 Hz	○
			37.9 kHz	72 Hz	○
	37.5 kHz		75 Hz	○	
	SVGA	800 x 600	35.1 kHz	56 Hz	○
			37.9 kHz	60 Hz	○
			48.1 kHz	72 Hz	○
			46.9 kHz	75 Hz	○
			48.4 kHz	60 Hz	○
	XGA	1024 x 768	56.5 kHz	70 Hz	○
			60.0 kHz	75 Hz	○
			47.7 kHz	60 Hz	○
			64.0 kHz	60 Hz	○
	WXGA	1360 x 768	47.7 kHz	60 Hz	○
SXGA	1280 x 1024	64.0 kHz	60 Hz	○	
1080p	1920 x 1080	67.5 kHz	60 Hz	—	

VGA and XGA are registered trademarks of International Business Machines Corp.

CLEARING THE SECRET NUMBER

If you forget the secret number, clear the secret number using the following procedure.

- Select "Parental CTRL" on the Setup menu to display the secret number screen. (For operating the on-screen display menu, see page 18.)
- Press and hold both **CH/∧** and **VOL +** on the TV simultaneously until the message appears on the screen.

The secret number is .

NOTE

- As a precautionary measure, make a note of your secret number above, and keep it in a safe place.

Specifications

Item		Model: LC-70LE600U	Model: LC-60LE600U	
LCD panel	Size	70" Class (69 1/2" Diagonal)	60" Class (60 1/32" Diagonal)	
	Resolution	2,073,600 pixels (1,920 × 1,080)		
TV Function	TV-standard (CCIR)	American TV Standard ATSC/NTSC System		
	Receiving Channel	VHF/UHF	VHF 2-13ch, UHF 14-69ch	
		CATV	1-135ch (non-scrambled channel only)	
		Digital Terrestrial Broadcast (8VSB)	2-69ch	
		Digital cable ¹ (64/256 QAM)	1-135ch (non-scrambled channel only)	
Audio multiplex	BTSC System			
Audio out	10W × 2			
Terminals	Rear	HDMI 1	HDMI in with HDCP, Audio in (ø 3.5 mm stereo minijack)	
		HDMI 2	HDMI in with HDCP	
		COMPONENT	COMPONENT in	
		PC IN	ANALOG RGB (PC) in (15-pin mini D-sub female connector), Audio in (ø 3.5 mm stereo minijack)	
		ANT/CABLE	75 Ω Unbalance, F Type × 1 for Analog (VHF/UHF/CATV) and Digital (AIR/CABLE)	
		AUDIO	Audio in (ø 3.5 mm stereo minijack)	
	Side	DIGITAL AUDIO OUTPUT	Optical Digital audio output × 1 (PCM/Dolby Digital)	
		OUTPUT	Audio out	
		HDMI 3	HDMI in with HDCP	
		VIDEO	AV in	
SERVICE	Software update			
OSD language	English/French/Spanish			
Power Requirement	AC 120 V, 60 Hz			
Power Consumption	214 W (0.2 W Standby with AC 120 V)		178 W (0.2 W Standby with AC 120 V)	
Weight	TV + stand	84.8 lbs./38.5 kg	61.7 lbs./28.0 kg	
	TV only	78.3 lbs./35.5 kg	55.1 lbs./25.0 kg	
Dimension ² (W × H × D)	TV + stand	63 19/32 × 39 47/64 × 13 1/8 inch	54 17/32 × 34 11/32 × 13 1/8 inch	
	TV only	63 19/32 × 38 7/16 × 3 1/2 inch	54 17/32 × 33 1/32 × 2 59/64 inch	
Operating temperature	+32°F to +104°F (0°C to +40°C)			

¹ Emergency alert messages via Cable are unreceivable.

² The dimensional drawings are shown on the Spanish operation manual. The width include the operation buttons.

- As part of policy of continuous improvement, SHARP reserves the right to make design and specification changes for product improvement without prior notice. The performance specification figures indicated are nominal values of production units. There may be some deviations from these values in individual units.

Cautions regarding use in high and low temperature environments

- When the unit is used in a low temperature space (e.g. room, office), the picture may leave trails or appear slightly delayed. This is not a malfunction, and the unit will recover when the temperature returns to normal.
 - Do not leave the unit in a hot or cold location. Also, do not leave the unit in a location exposed to direct sunlight or near a heater, as this may cause the cabinet to deform and the Liquid Crystal panel to malfunction.
- Storage temperature: -4°F to +140°F (-20°C to +60°C)

Information on the Software License for This Product

■ Software composition

The software included in this product is comprised of various software components whose individual copyrights are held by SHARP or by third parties.

■ Software developed by SHARP and open source software

The copyrights for the software components and various relevant documents included with this product that were developed or written by SHARP are owned by SHARP and are protected by the Copyright Act, international treaties, and other relevant laws. This product also makes use of freely distributed software and software components whose copyrights are held by third parties.

■ Obtaining source code

Some of the open source software licensors require the distributor to provide the source code with the executable software components. For information on obtaining the source code for the open source software, and other license agreement information, visit the following website:

<http://www.sharppusa.com/software>

We are unable to answer any questions about the source code for the open source software. The source code for the software components whose copyrights are held by SHARP is not distributed.

■ Acknowledgements

The following open source software components are included in this product:

- SIL OPEN FONT LICENSE Version 1.0/Bitstream Vera Fonts/LARABIE FONTS

■ Software Copyrights

SIL OPEN FONT LICENSE Version 1.0

This Font Software is Copyright © 2003-2005, SIL International (<http://scripts.sil.org/>). All Rights Reserved.

Bitstream Vera Fonts

Copyright © 2003 by Bitstream, Inc. All Rights Reserved. Bitstream Vera is a trademark of Bitstream, Inc.

Permission is hereby granted, free of charge, to any person obtaining a copy of the fonts accompanying this license ("Fonts") and associated documentation files (the "Font Software"), to reproduce and distribute the Font Software, including without limitation the rights to use, copy, merge, publish, distribute, and/or sell copies of the Font Software, and to permit persons to whom the Font Software is furnished to do so, subject to the following conditions:

The above copyright and trademark notices and this permission notice shall be included in all copies of one or more of the Font Software typefaces.

The Font Software may be modified, altered, or added to, and in particular the designs of glyphs or characters in the Fonts may be modified and additional glyphs or characters may be added to the Fonts, only if the fonts are renamed to names not containing either the words "Bitstream" or the word "Vera".

This License becomes null and void to the extent applicable to Fonts or Font Software that has been modified and is distributed under the "Bitstream Vera" names.

The Font Software may be sold as part of a larger software package but no copy of one or more of the Font Software typefaces may be sold by itself.

THE FONT SOFTWARE IS PROVIDED "AS IS", WITHOUT WARRANTY OF ANY KIND, EXPRESS OR IMPLIED, INCLUDING BUT NOT LIMITED TO ANY WARRANTIES OF MERCHANTABILITY, FITNESS FOR A PARTICULAR PURPOSE AND NONINFRINGEMENT OF COPYRIGHT, PATENT, TRADEMARK, OR OTHER RIGHT. IN NO EVENT SHALL BITSTREAM OR THE GNOME FOUNDATION BE LIABLE FOR ANY CLAIM, DAMAGES OR OTHER LIABILITY, INCLUDING ANY GENERAL, SPECIAL, INDIRECT, INCIDENTAL, OR CONSEQUENTIAL DAMAGES, WHETHER IN AN ACTION OF CONTRACT, TORT OR OTHERWISE, ARISING FROM, OUT OF THE USE OR INABILITY TO USE THE FONT SOFTWARE OR FROM OTHER DEALINGS IN THE FONT SOFTWARE.

Except as contained in this notice, the names of Gnome, the Gnome Foundation, and Bitstream Inc., shall not be used in advertising or otherwise to promote the sale, use or other dealings in this Font Software without prior written authorization from the Gnome Foundation or Bitstream Inc., respectively. For further information, contact:
fonts at gnome dot org.

LARABIE FONTS

This Font Software is Copyright © 1996-2001, Ray Larabie. All Rights Reserved.

Calling for Service

For location of the nearest Sharp Authorized Service, or to obtain product literature, accessories, supplies, or customer assistance, please call 1-800-BE-SHARP.

LIMITED WARRANTY

CONSUMER LIMITED WARRANTY

SHARP ELECTRONICS CORPORATION warrants to the first consumer purchaser that this Sharp brand Liquid Crystal Display product (the "Product"), when shipped in its original container, will be free from defective workmanship and materials, and agrees that it will, at its option, either repair the defect or replace the defective Product or part thereof with a new or remanufactured equivalent at no charge to the purchaser for parts or labor for the period(s) set forth below.

This warranty does not apply to any appearance items of the Product or if the serial number or model number affixed to the Product has been removed, defaced, changed, altered or tampered with. This warranty does not cover installation or signal reception problems. This limited warranty will not apply if the Product has been or is being used in a commercial setting or application; this warranty is meant solely for the non-commercial, household use of the Product by consumers in their home or residence. If you intend to or already use this Product for commercial purposes or in a commercial setting, there are warranties available to cover your use of this Product, the terms of which may vary. Please contact 1-888-GO-SHARP for further information.

In order to enforce your rights under this limited warranty, you should follow the steps set forth below. You must be able to provide proof of purchase to the servicer, which proof must include the date of purchase.

To the extent permitted by applicable state law, the warranties set forth are in lieu of, and exclusive of, all other warranties, express or implied. Specifically ALL OTHER WARRANTIES OTHER THAN THOSE SET FORTH ABOVE ARE EXCLUDED. ALL EXPRESS AND IMPLIED WARRANTIES INCLUDING THE WARRANTIES OF MERCHANTABILITY, FITNESS FOR USE, AND FITNESS FOR A PARTICULAR PURPOSE ARE SPECIFICALLY EXCLUDED. IF, UNDER APPLICABLE STATE LAW, IMPLIED WARRANTIES MAY NOT VALIDLY BE DISCLAIMED OR EXCLUDED, THE DURATION OF SUCH IMPLIED WARRANTIES IS LIMITED TO THE PERIOD(S) FROM THE DATE OF PURCHASE SET FORTH BELOW. THIS WARRANTY GIVES YOU SPECIFIC LEGAL RIGHTS. YOU MAY ALSO HAVE OTHER RIGHTS WHICH VARY FROM STATE TO STATE.

The warranties given herein shall be the sole and exclusive warranties granted by Sharp and shall be the sole and exclusive remedy available to the purchaser and only for the time periods set forth herein. No other representations or promises made by anyone are permitted. Correction of defects, in the manner and for the period of time described herein, shall constitute complete fulfillment of all liabilities and responsibilities of Sharp to the purchaser with respect to the Product, and shall constitute full satisfaction of all claims, whether based on contract, negligence, strict liability or otherwise. Sharp does not warrant nor shall Sharp be liable, or in any way responsible, for Products which have been subject to abuse (including, but not limited to, improper voltage), accident, misuse, negligence, lack of reasonable care, alteration, modification, tampering, misuse, improper operation or maintenance or any damages or defects in the Product which were caused by repairs or attempted repairs performed by anyone other than a Sharp authorized servicer. Nor shall Sharp be liable or in any way responsible for any incidental or consequential economic or property damage. Some states do not allow limits on warranties or on remedies for breach in certain transactions; in such states, the limits herein may not apply.

THIS LIMITED WARRANTY IS VALID ONLY IN THE FIFTY (50) UNITED STATES, THE DISTRICT OF COLUMBIA AND PUERTO RICO.

Model Specific Section

Your Product Model Number & Description:

LC-70LE600J/LC-60LE600J LCD Color Television
(Be sure to have this information available when you need service for your Product.)

Warranty Period for this Product:

One (1) year parts and labor from the date of purchase.

Additional Exclusions from Warranty Coverage (if any):

In order for the Product to be serviced, the Product must be readily available to the servicer, free and clear of any complex or non-standard installation, mounting or other encumbrance which would unreasonably interfere with servicing the Product. The Servicer will remount the Product after service, provided that such remounting is not into a complex or non-standard installation. Any additional labor and materials required to remove and/or reinstall a Product above and beyond the foregoing are not covered by this warranty, may result in additional charges and are the responsibility of the consumer. Image Retention resulting from a fixed image being displayed for long periods of time is not covered by this Limited Warranty (see Operation Manual on how to prevent this).

Where to Obtain Service:

From a Sharp Authorized Servicer located in the United States. To find the location of the nearest Sharp Authorized Servicer, please call Sharp toll free at 1-800-BE-SHARP.

What to do to Obtain Service:

Contact your Sharp Authorized Servicer to obtain in home service for this product. The Servicer will come to your location and if necessary remove the unit for repair at the Servicer's facility and return the set to you once completed. Be sure to have **Proof of Purchase** available.

TO OBTAIN PRODUCT INFORMATION OR PURCHASE ACCESSORIES AND EXTENDED WARRANTIES, CALL 1-800-BE-SHARP OR VISIT www.sharpsusa.com

SHARP®

SHARP ELECTRONICS CORPORATION

Sharp Plaza, Mahwah, New Jersey 07495-1163

SHARP CORPORATION

SHARP®

LIMITED WARRANTY

Consumer Electronics Products

Congratulations on your purchase!

Sharp Electronics of Canada Ltd. ("Sharp") warrants to the first purchaser for this Sharp brand product ("Product"), when shipped in its original container and sold or distributed in Canada by Sharp or by an authorized Sharp dealer, and Product was not sold "as is" or "sales final" that the Product will during the applicable warranty period, be free from defects in material and workmanship, and will within the applicable warranty period, either repair the defective Product or provide the first purchaser a replacement of the defective Product.

Conditions: This limited warranty shall not apply to:

- Any defects caused or repairs required as a result of abusive operation, negligence, accident, improper installation or inappropriate use as outlined in the owner's manual or other applicable Product documentation.
- Any defects caused or repairs required as a result of any Product that has been tampered with, modified, adjusted or repaired by any person other than Sharp, a Sharp authorized service centre or a Sharp authorized servicing dealer.
- Any defects caused or repairs required as a result of the use of the Product with items not specified or approved by Sharp, including but not limited to, head cleaning tapes and chemical cleaning agents.
- Any replacement of accessories, glassware, consumable or peripheral items required through normal use of the Product, including but not limited to, earphones, remote controls, AC adapters, batteries, temperature probe, trays, filters, belts, ribbons, cables and paper.
- Any cosmetic damage to the Product surface or exterior that has been defaced or caused by normal wear and tear.
- Any defects caused or repairs required as a result of damage caused by any external or environmental conditions, including but not limited to, transmission line/power line voltage or liquid spillage or acts of God.
- Warranty claims for Products returned with illegible or without appropriate model, serial number and CSA/cUL markings.
- Any Products used for rental or commercial purposes.
- Any installation, setup and/or programming charges.

How to get service: Warranty service may be obtained upon delivery of the Product, together with proof of purchase (including date of purchase) and a copy of this limited warranty statement, to an authorized Sharp service centre or an authorized Sharp servicing dealer. In home warranty service will be carried out to locations accessible by on-road service vehicle and within 50 km of an authorized Sharp service centre on any Sharp Television with the screen size of 42" or larger and on any Sharp Over-The-Range Microwave Oven or Home Use Microwave Drawer. No other person (including any Sharp dealer or service centre) is authorized to extend, enlarge or transfer this warranty on behalf of Sharp. The purchaser will be responsible for any and all removal, reinstallation, transportation and insurance costs incurred.

The express warranties in this limited warranty are, except for consumer purchasers domiciled in Quebec, in lieu of and, except to the extent prohibited by applicable law, Sharp disclaims all other warranties and conditions, express or implied, whether arising by law, statute, by course of dealing or usage of trade, including, without limitation, implied warranties or conditions of merchantability and/or quality, fitness for a particular use or purpose, and/or non-infringement. **Limitations** (not applicable to consumer purchasers domiciled in Quebec to the extent prohibited under Quebec law): (a) Sharp shall not be liable for any incidental, special, consequential, economic, exemplary or indirect damages of any kind or nature (including lost profits or damages for loss of time or loss of use or loss of data) arising from or in any connection with the use or performance of a Product or a failure of a Product, even if Sharp is aware of or has been advised of the possibility of such damages; (b) the remedies described in this limited warranty constitute complete fulfillment of all obligations and responsibilities of Sharp to the purchaser with respect to the Product and shall constitute full satisfaction of all claims, whether based on contract, negligence, strict liability or otherwise. Some provinces may not allow the exclusion or limitation of certain damages, or limits on the duration or voiding of implied warranties or conditions; in such provinces, the exclusions and limits herein may not apply. This limited warranty is, except for consumer purchasers domiciled in Quebec, governed by the laws of the Province in Canada in which the purchaser has purchased the Product. For consumer purchasers domiciled in Quebec this limited warranty is governed by the laws of Quebec.

WARRANTY PERIODS (calculated from the date of original purchase): Parts & Labour (exceptions noted)

Audio Product	1 year
Blu-Ray Product	1 year
Projector	1 year (lamp 90 days)
LCD TV	1 year
Microwave Oven	1 year (magnetron component-4 additional years)
Air Purifier	1 year
Portable Air Conditioner	1 year
Plasmacluster Ion Generator	1 year
3D Glasses	1 year
Wireless LAN Adapter	1 year

To obtain the name and address of the nearest Authorized Sharp Service Centre or Dealer, or for more information on this Limited Warranty, Sharp Extended Warranty Offers, Sharp Canada Products or Accessory Sales, please contact Sharp:

- By writing to Sharp Electronics Of Canada Ltd. at 335 Britannia Road East
Mississauga, Ontario L4Z 1W9
- Calling: at 905-568-7140
- Visiting our Web site: www.sharp.ca



THIS LIMITED WARRANTY IS VALID ONLY IN CANADA

Dimensional Drawings

Unit: inch (mm)
 Unité: pouce (mm)
 Unidad: pulgada (mm)

LC-70LE600U

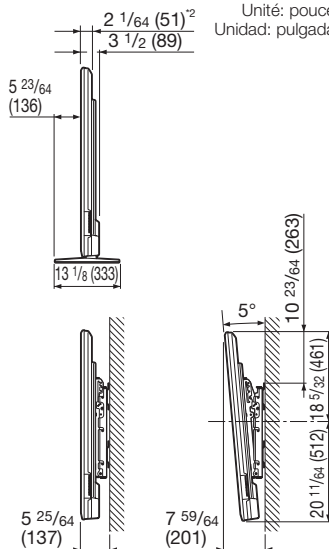
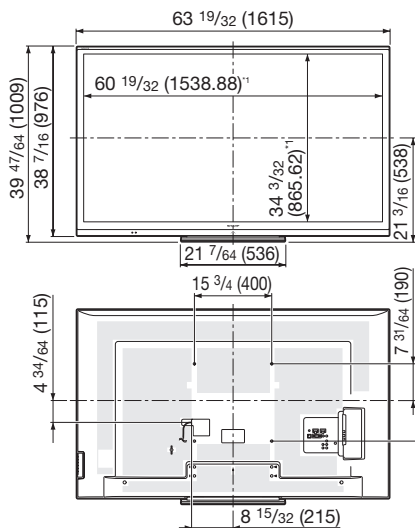

AN-52AG4

LC-60LE600U

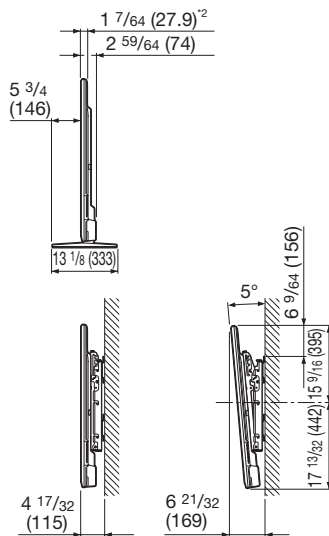
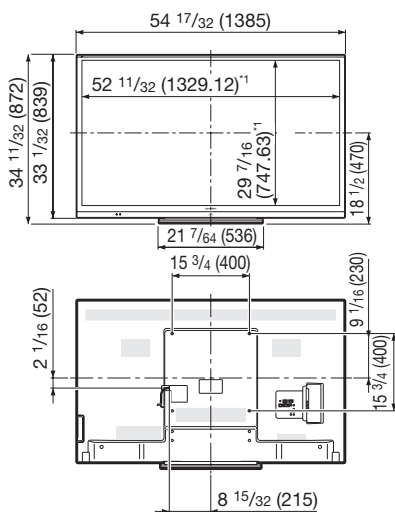

AN-52AG4

¹ Active area/Área activa/Zona activa

² Thinnest part/Parte más delgada/Partie la plus mince