

SANYO

No. 3938

LC7232-8377**Single-chip PLL and Microcontroller
with LCD Driver****Preliminary****OVERVIEW**

The LC7232-8377 is a single-chip microcontroller that incorporates a phase-locked loop (PLL) and a liquid crystal display driver. It supports remote control operation and incorporates an anti-theft function, making it ideal for use in car radios.

The LC7232-8377 operates over the American, Eastern and Western European, Saudi Arabian, South African and Japanese LW, MW, SW and FM bands and incorporates preset-channel memory for six stations in each band for a total of 36 stations. In addition, the LC7232-8377 supports a traffic-information function for European frequency bands, 12-hour and 24-hour time displays, automatic retuning, automatic station storage and a voltage-monitoring reset circuit.

The LC7232-8377 operates from a 5 V supply and is available in 80-pin QIPs.

FEATURES

- Infrared or wired remote control operation
- Anti-theft function
- American, Eastern and Western European, Saudi Arabian and Japanese frequency band selections
- Operates over the LW (SW), MW, FM1, FM2 and FM3 bands
- Preset-channel memory for six stations for each band
- Last-channel memory for each band
- Traffic-information function for European frequency bands
- Automatic station scanning with 5 s station pause
- Preset-channel scanning function
- 4.5 MHz reference frequency for tracking adjustment
- Automatic retuning function
- Automatic station storage function
- Voltage-monitoring reset circuit
- 12-hour and 24-hour time displays
- Frequency select key inputs for manual tuning
- Time setting key inputs
- 5 V supply
- 80-pin QIP

PINOUT

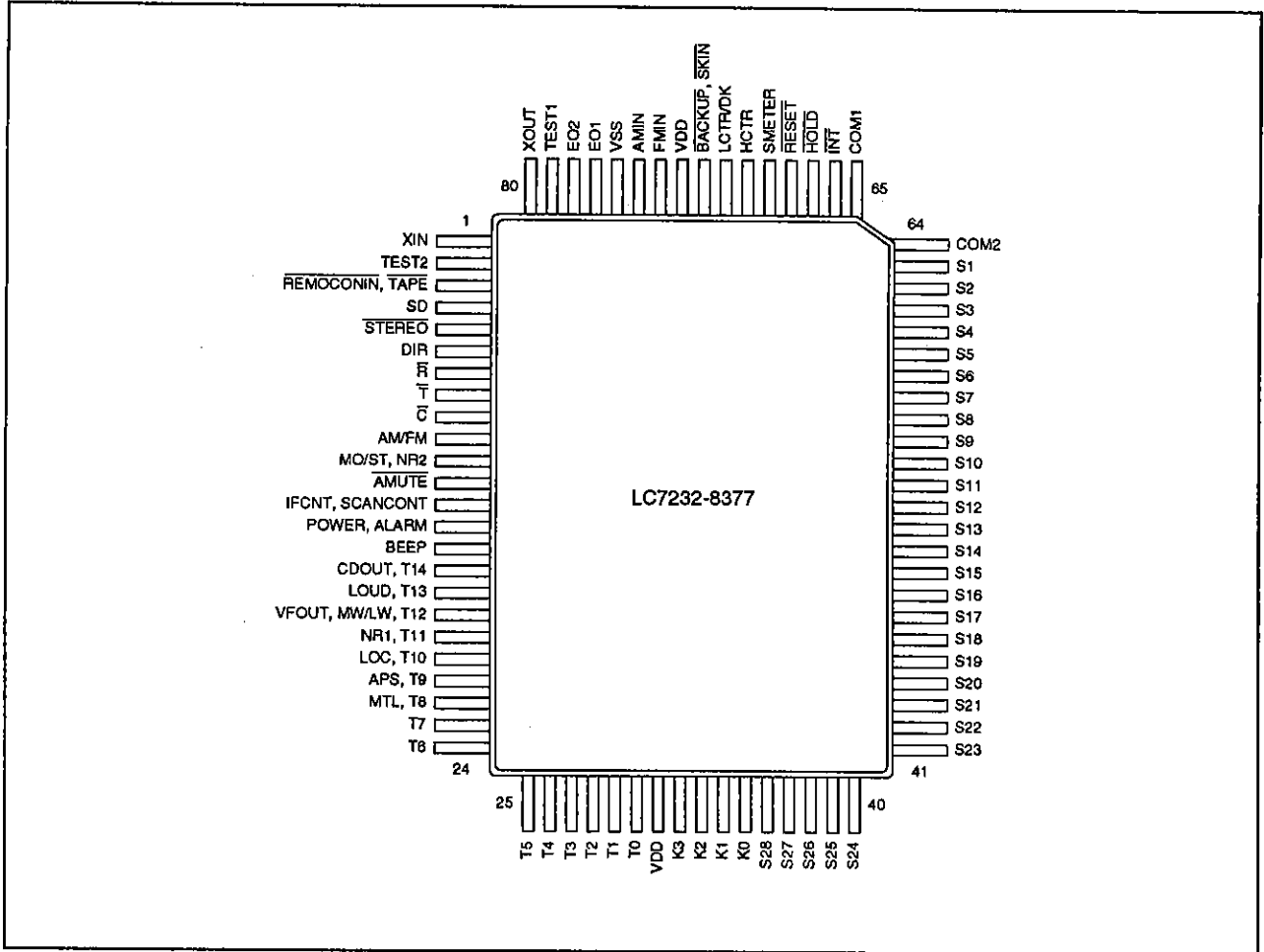

PACKAGE DIMENSIONS

Unit: mm

3044B-QIP80A

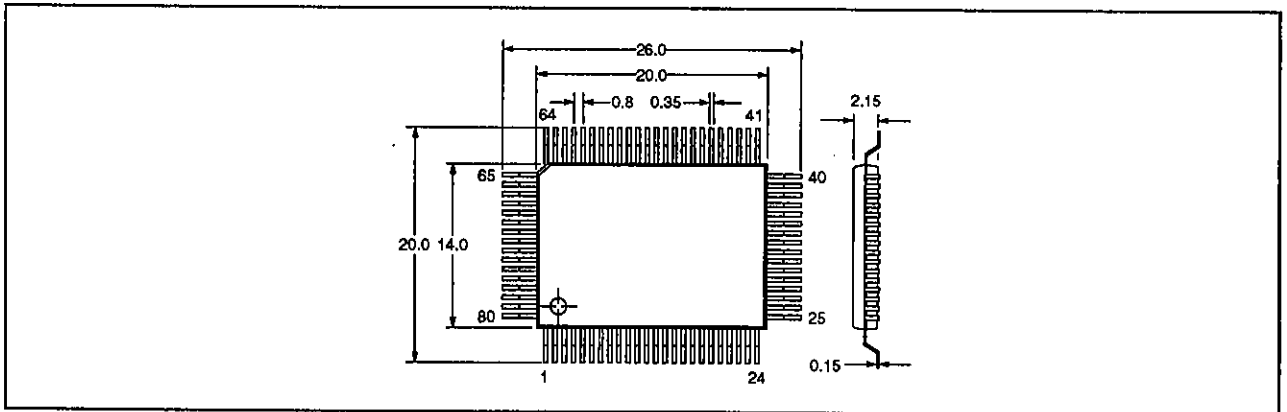

PIN DESCRIPTION

Number	Name	Description
1	XIN	4.5 MHz crystal connection
2	TEST2	Test input 2
3	REMOCONIN, TAPE	Remote control or Tape mode select input
4	SD	Auto-tuning station detect indication input
5	STEREO	Stereo indication input
6	DIR	Tape direction control input
7	\bar{R}	Radio-source control signal, open-drain output
8	\bar{T}	Tape-source control signal, open-drain output
9	\bar{C}	CD-source control signal, open-drain output
10	AM/FM	AM/FM band select output
11	MO/ST, NR2	Stereo or noise reduction mode control signal output
12	AMUTE	Audio mute output
13	IFCONT, SCANCONT	IF counter buffer ON/OFF or diode-matrix scan in progress control signal output
14	POWER, ALARM	Power-on sequence or VF ON mode SKIN alarm indication output
15	BEEP	Key-press control signal output
16	CDOUT, T14	CD power supply control or diode-matrix scan output
17	LOUD, T13	'LOUD' control signal or diode-matrix scan output
18	VFOOUT, MW/LW, T12	VF control, MW/LW band select or diode-matrix scan output
19	LOC, T11	LOC mode ON or diode-matrix scan output
20	NR1, T10	Noise reduction ON or diode-matrix scan output
21	APS, T9	APS mode ON or diode-matrix scan output
22	MTL, T8	Metal tape mode ON or diode-matrix scan output
23	T7	Diode-matrix scan output
24 to 30	T6 to T0	Keypad scan outputs
31, 73	VDD	5 V supply
32 to 35	K3 to K0	Keypad and diode-matrix scan inputs
36 to 63	S28 to S1	LCD segment driver outputs
64, 65	COM2, COM1	LCD common driver outputs
66	\bar{INT}	Remote control signal input
67	\bar{HOLD}	HOLD and BACKUP modes control input
68	\bar{RES}	Active-LOW reset input
69	SMETER	S-meter output
70	HCTR	FMIF or AMIF signal input
71	LCTR, DK	AMIF or 125 Hz DK signal input
72	SKIN, BACKUP	SK detector or anti-theft sensor input
74	FMIN	FM local-oscillator input
75	AMIN	Am local-oscillator input
76	VSS	Ground

Number	Name	Description
77, 78	EO1, EO2	Phase comparator outputs
79	TEST1	Test input
80	XOUT	4.5 MHz crystal connection

SPECIFICATIONS

Absolute Maximum Ratings

Parameter	Symbol	Rating	Unit
Supply voltage range	V_{DD}	-0.3 to 6.5	V
HOLD, INT, RES, SMETER and BACKUP input voltage range	V_{I1}	-0.3 to 13	V
Input voltage range for all other pins	V_{I2}	-0.3 to $V_{DD} + 0.3$	V
\bar{R} , \bar{T} , \bar{C} and AM/FM output voltage range	V_{O1}	-0.3 to 15	V
Output voltage range for all other pins	V_{O2}	-0.3 to $V_{DD} + 0.3$	V
\bar{R} , \bar{T} , \bar{C} , AM/FM and T8 to T11 output current range	I_{O1}	0 to 5	mA
Output current range. See note.	I_{O2}	0 to 3	mA
T0 to T7 output current range	I_{O3}	0 to 1	mA
Power dissipation	P_D	400	mW
Operating temperature range	T_{opr}	-40 to 85	°C
Storage temperature range	T_{stg}	-45 to 125	°C

Note

Pins MO/ST, BEEP, POWER, IFCNT, T12 to T14 and S1 to S28

Recommended Operating Conditions

$T_a = 25\text{ °C}$

Parameter	Symbol	Rating	Unit
Supply voltage	V_{DD}	5	V
Supply voltage range for CPU and PLL operation	V_{DD1}	4.5 to 5.5	V
Supply voltage range for CPU operation	V_{DD2}	3.5 to 5.5	V
Supply voltage range for data retention	V_{DD3}	1.3 to 5.5	V

Electrical Characteristics

$V_{DD} = 3.5$ to 5.5 V, $T_a = -40$ to 85 °C unless otherwise noted

Parameter	Symbol	Condition	Rating			Unit
			min	typ	max	
Supply current	I_{DD}	$V_{DD} = 4.5$ to 5.5 V, $f_{MIN} = 130$ MHz	-	15	20	mA
		$V_{DD} = 3.5$ to 5.5 V, PLL halted	-	0.7	-	
		$V_{DD} = 5.5$ V, oscillator halted, $T_a = 25\text{ °C}$	-	-	5	μ A
		$V_{DD} = 2.5$ V, oscillator halted, $T_a = 25\text{ °C}$	-	-	1	

LC7232-8377

Parameter	Symbol	Condition	Rating			Unit
			min	typ	max	
REMOCONIN, SD, DIR and STEREO LOW-level input voltage	V_{IL1}		0	–	$0.3V_{DD}$	V
HOLD LOW-level input voltage	V_{IL2}		0	–	$0.4V_{DD}$	V
\overline{RES} and \overline{INT} LOW-level input voltage	V_{IL3}		0	–	$0.2V_{DD}$	V
\overline{BACKUP} LOW-level input voltage	V_{IL4}		0	–	1.3	V
K0 to K3 LOW-level input voltage	V_{IL5}		0	–	$0.2V_{DD}$	V
LCTR LOW-level input voltage	V_{IL6}		0	–	$0.2V_{DD}$	V
LOW-level input voltage. See note 1.	V_{IL7}		0	–	$0.3V_{DD}$	V
REMOCONIN, SD, DIR and STEREO HIGH-level input voltage	V_{IH1}		$0.7V_{DD}$	–	8.0	V
HOLD, \overline{RES} and \overline{INT} HIGH-level input voltage	V_{IH2}		$0.8V_{DD}$	–	8.0	V
\overline{BACKUP} HIGH-level input voltage	V_{IH3}		2.5	–	8.0	V
K0 to K3 HIGH-level input voltage	V_{IH4}		$0.6V_{DD}$	–	V_{DD}	V
LCTR HIGH-level input voltage	V_{IH5}		$0.8V_{DD}$	–	V_{DD}	V
HIGH-level input voltage. See note 1.	V_{IH6}		$0.7V_{DD}$	–	V_{DD}	V
XIN rms input amplitude	V_{i1}		0.50	–	1.5	V
FMIN rms input amplitude	V_{i2}		0.10	–	1.5	V
AMIN rms input amplitude	V_{i3}		0.15	–	1.5	V
HCTR rms input amplitude	V_{i4}		0.10	–	1.5	V
SMETER input voltage	V_{i5}		0	–	V_{DD}	V
LOW-level input current. See note 5.	I_{IL1}	$V_i = V_{SS}$	–	–	3.0	μA
LOW-level input current. See note 1.	I_{IL2}	$V_i = V_{SS}$	–	–	3.0	μA
XIN LOW-level input current	I_{IL3}	$V_i = V_{SS}$	2.0	5.0	15.0	μA
FMIN, AMIN, HCTR and LCTR LOW-level input voltage	I_{IL4}	$V_i = V_{SS}$	4.0	10.0	30.0	μA
HIGH-level input current. See note 5.	I_{IH1}	$V_i = 5.5 V$	–	–	3.0	μA
HIGH-level input current. See note 1.	I_{IH2}	$V_i = V_{DD}$. \overline{AMUTE} is OFF.	–	–	3.0	μA
XIN HIGH-level input current	I_{IH3}	$V_i = V_{DD} = 5.0 V$	2.0	5.0	15.0	μA
FMIN, AMIN, HCTR and LCTR HIGH-level input current	I_{IH4}	$V_i = V_{DD} = 5.0 V$	4.0	10.0	30.0	μA
K0 to K3 HIGH-level input current	I_{IH5}	$V_i = V_{DD} = 5.0 V$	–	50	–	μA
XIN input frequency	f_{i1}	$V_{XIN} = 0.5 \text{ to } 1.5 V$, $V_{DD} = 4.5 \text{ to } 5.5 V$	4.0	4.5	5.0	MHz
FMIN input frequency	f_{i2}	$V_{FMIN} = 0.1 \text{ to } 1.5 V$, $V_{DD} = 4.5 \text{ to } 5.5 V$	10	–	190	MHz
AMIN input frequency	f_{i3}	$V_{AMIN} = 0.15 \text{ to } 1.5 V$, $V_{DD} = 4.5 \text{ to } 5.5 V$	0.5	–	10.0	MHz
HCTR input frequency	f_{i4}	$V_{HCTR} = 0.1 \text{ to } 1.5 V$, $V_{DD} = 4.5 \text{ to } 5.5 V$	0.4	–	12.0	MHz
LCTR input frequency	f_{i5}	AMIF signal and $V_{LCTR} = 0.15 \text{ to } 1.5 V$, or DK signal and $V_{LCTR} = V_{IL6}$ or V_{IH5} , $V_{DD} = 4.5 \text{ to } 5.5 V$	0.001	–	500	kHz

LC7232-8377

Parameter	Symbol	Condition	Rating			Unit
			min	typ	max	
T0 to T7 LOW-level output voltage	V_{OL1}	$I_o = 1 \text{ mA}$	0.5	1.0	2.0	V
LOW-level output voltage. See note 2.	V_{OL2}	$I_o = 1 \text{ mA}$	-	-	1.0	V
EO1 and EO2 LOW-level output voltage	V_{OL3}	$I_o = 500 \text{ }\mu\text{A}$	-	-	1.0	V
XOUT LOW-level output voltage	V_{OL4}	$I_o = 200 \text{ }\mu\text{A}$	-	-	1.0	V
S1 to S28 LOW-level output voltage	V_{OL5}	$I_o = 0.1 \text{ mA}$	-	-	1.0	V
T8 to T11 LOW-level output voltage	V_{OL6}	$I_o = 5 \text{ mA}$	-	-	1.0	V
COM1 and COM2 LOW-level output voltage	V_{OL7}	$I_o = 20 \text{ }\mu\text{A}$	-	-	1.0	V
R, T, C and AM/FM LOW-level output voltage	V_{OL8}	$I_o = 5 \text{ mA}$, $R_L = 150 \text{ to } 400 \text{ }\Omega$	0.75	-	2.0	V
COM1 and COM2 middle-level output voltage	V_M	$V_{DD} = 5 \text{ V}$, $I_o = 20 \text{ }\mu\text{A}$	2.0	2.5	3.0	V
T0 to T7 HIGH-level output voltage	V_{OH1}	$I_o = 1 \text{ mA}$	$V_{DD} - 2.0$	$V_{DD} - 1.0$	$V_{DD} - 0.5$	V
HIGH-level output voltage. See note 2.	V_{OH2}	$I_o = 1 \text{ mA}$	$V_{DD} - 1.0$	-	-	V
EO1 and EO2 HIGH-level output voltage	V_{OH3}	$I_o = 500 \text{ }\mu\text{A}$	$V_{DD} - 1.0$	-	-	V
XOUT HIGH-level output voltage	V_{OH4}	$I_o = 200 \text{ }\mu\text{A}$	$V_{DD} - 1.0$	-	-	V
S1 to S28 HIGH-level output voltage	V_{OH5}	$I_o = -0.1 \text{ mA}$	$V_{DD} - 1.0$	-	-	V
T8 to T11 HIGH-level output voltage	V_{OH6}	$I_o = 5 \text{ mA}$	$V_{DD} - 1.0$	-	-	V
COM1 and COM2 HIGH-level output voltage	V_{OH7}	$I_o = 20 \text{ }\mu\text{A}$	$V_{DD} - 0.7$	$V_{DD} - 0.5$	$V_{DD} - 0.35$	V
RES and INT hysteresis width	V_{HYS}		$0.1V_{DD}$	-	-	V
BACKUP reject pulsewidth	t_{REJ}		-	-	50	μs
Low-voltage detector threshold	V_{DET}		2.7	3.0	3.3	V
K0 to K3 floating-input voltage	V_{IF}		-	-	$0.05V_{DD}$	V
K0 to K3 pull-down resistor	R_{PD}		75	100	200	$\text{k}\Omega$
EO1 and EO2 LOW-level leakage current	I_{OFFL1}	$V_o = V_{SS}$	-	0.01	10.0	nA
LOW-level leakage current. See note 3.	I_{OFFL2}	$V_o = V_{SS}$	-	-	3.0	μA
EO1 and EO2 HIGH-level leakage current	I_{OFFH1}	$V_o = V_{DD}$	-	0.01	10.0	nA
HIGH-level leakage current. See note 3.	I_{OFFH2}	$V_o = V_{DD}$	-	-	3.0	μA
R, T, C and AM/FM HIGH-level leakage current	I_{OFFH3}	$V_o = 13 \text{ V}$	-	-	5.0	μA

Notes

1. Pins MO/ST, BEEP, POWER, IFCNT, $\overline{\text{AMUTE}}$ and T12 to T14
2. Pins MO/ST, BEEP, POWER, IFCNT, $\overline{\text{AMUTE}}$, T12 to T14 and S25 to S28
3. Pins MO/ST, BEEP, POWER, IFCNT, $\overline{\text{AMUTE}}$ and T0 to T14
4. Pins MO/ST, BEEP, POWER, IFCNT, $\overline{\text{AMUTE}}$, T0 to T14 and S25 to S28
5. Pins $\overline{\text{INT}}$, $\overline{\text{HOLD}}$, $\overline{\text{RES}}$, SMETER, $\overline{\text{BACKUP}}$, SD, $\overline{\text{REMOCONIN}}$, $\overline{\text{STEREO}}$ and DIR

Measurement Circuits

HOLD mode

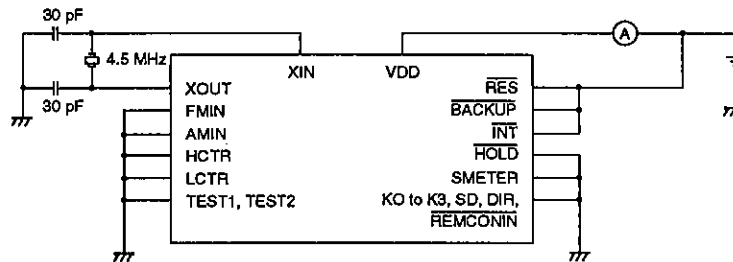

Note

T0 to T4, BEEP, POWER, IFCNT, $\overline{\text{AMUTE}}$, MO/ST, AM/FM, $\overline{\text{R}}$, $\overline{\text{T}}$, $\overline{\text{C}}$, S1 to S28, COM1 and COM2 are open.

BACKUP mode

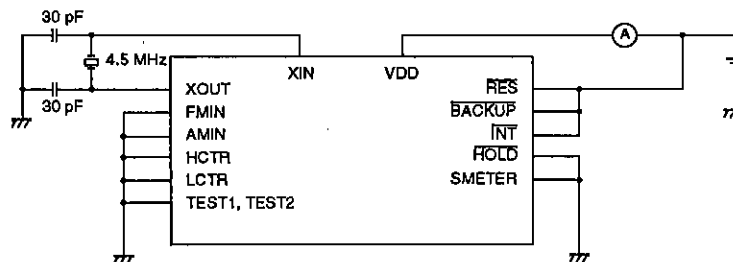

Note

T0 to T4, BEEP, POWER, IFCNT, $\overline{\text{AMUTE}}$, MO/ST, AM/FM, $\overline{\text{R}}$, $\overline{\text{T}}$, $\overline{\text{C}}$, S1 to S28, COM1 and COM2 are open.

FUNCTIONAL DESCRIPTION

Pin Functions

SD

The auto-tuning circuit should set SD HIGH when it detects a station.

DIR

When the TAPE IND diode is not connected, this input controls the tape direction indicators in the LCD panel. When DIR is HIGH, the right arrow is ON, and when LOW, the left arrow. DIR should be tied to either V_{DD} or V_{SS} if it is not used.

$\overline{\text{REMOCONIN}}$, TAPE

$\overline{\text{REMOCONIN}}$ receives the codes generated by an LC7461M remote control transmitter IC.

When the remote control function is not used, this input can be used instead of the TAPE transistor in the transistor matrix.

$\overline{\text{STEREO}}$

When the radio is in FM or VF ON mode and $\overline{\text{HOLD}}$ is HIGH, the **ST** LCD segment is set ON 500 ms after $\overline{\text{STEREO}}$ goes LOW. $\overline{\text{STEREO}}$ should be tied to V_{DD} if it is not used.

$\overline{\text{INT}}$

$\overline{\text{INT}}$ also receives the codes generated by the remote control transmitter IC.

BACKUP, SKIN

When the ANTI THEFT diode is connected, this input is used to detect when the MEMO line on a drawer-type unit is cut.

When not used as $\overline{\text{BACKUP}}$, this input can be used instead of the SKIN transistor in the transistor matrix.

SMETER

The SMETER input voltage range is 0 to 3.2 V. If the S-meter output voltage exceeds 3.2 V, use a voltage

divider. SMETER should be connected to V_{DD} to store station frequencies using the **M1** key.

HCTR

The HCTR input signal should be ac-coupled and have a 100 mV minimum level. The HCTR error at FM, MW and LW frequencies is ±10, ±3 and ±0.6 kHz, respectively.

S1 to S28, COM1 and COM2

The LC7232-8377 is designed to be used with an LCD-8162JP LCD panel, which has segment and common patterns as shown in figures 1 and 2, respectively. The segments selected with the S1 to S28 and COM1 and COM2 outputs are shown in table 1. Example displays are shown in figures 3 to 14.

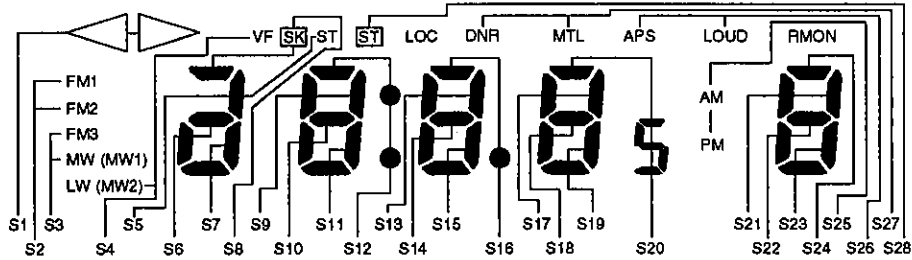

Figure 1. LCD-8162JP segment pattern

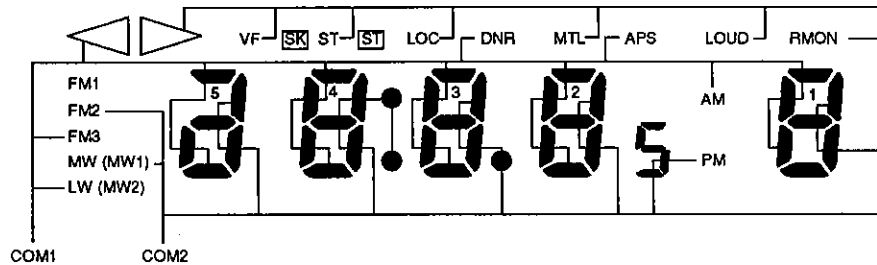

Figure 2. LCD-8162JP common pattern

Table 1. LCD segment selection

Segment	COM1	COM2	Segment	COM1	COM2
S1	←	⇒	S15	3d	3c
S2	FM1	FM2	S16	3a	dp
S3	FM3	MW (MW1)	S17	2f	2b
S4	LW (MW2)	VF	S18	2e	2g
S5	ST	5b	S19	2d	2c
S6	5e	5g	S20	2a	5
S7	5d	5c	S21	1f	1b
S8	5a	SK	S22	1e	1g
S9	4f	4b	S23	1d	1c
S10	4e	4g	S24	1a	RMON
S11	4d	4c	S25	AM	PM
S12	4a	colon	S26	APS	LOUD
S13	3f	3b	S27	DNR	MTL
S14	3e	3g	S28	ST	LOC

87.5₅ 3

Figure 3. Radio mode FM frequency display

1720 6

Figure 4. Radio mode AM frequency display

▷ 106.1 4

Figure 5. VF ON mode FM frequency display when DK is ON

◁ TAPE 6

Figure 6. Tape mode tape display when Dolby B NR is ON

c - c C

Figure 7. Tape mode tape run display when Dolby C NR is ON

▷ 12:00

Figure 8. Tape mode 12-hour clock display

◁ 23:00 6

Figure 9. Tape mode 24-hour clock display when Dolby B NR is ON

[d

Figure 10. CD mode CD display when CD SELECT is connected

SEC F

Figure 11. Anti-theft mode factory code input display

SEC P

Figure 12. Anti-theft mode personal code input display

PC

Figure 13. Anti-theft mode P.C. code recording display

89.5 P

Figure 14. Radio mode display when **ME** has been pressed

HOLD

When the clock display is disabled, a HIGH-to-LOW transition on $\overline{\text{HOLD}}$ places the controller in BACKUP mode. If the clock display is enabled, a HIGH-to-LOW transition on $\overline{\text{HOLD}}$ places the controller in HOLD mode.

T0 to T14 and K0 to K3

T0 to T14 and K0 to K3 are the diode matrix, transistor matrix and key matrix inputs and outputs, respectively. The diode and transistor matrices are scanned at power-up and following a LOW-to-HIGH transition on $\overline{\text{HOLD}}$. T7 to T14 also have other functions.

BEEP

BEEP goes HIGH for approximately 50 ms following a key press.

POWER, ALARM

The POWER output is HIGH during the power-on sequence if the POWER SW diode is connected and the **POWER** key is ON.

If, in VF ON mode, $\overline{\text{SKIN}}$ is HIGH for greater than 30 s, ALARM goes HIGH and the controller automati-

cally searches for a higher frequency for which \overline{SKIN} goes LOW. \overline{SKIN} is checked approximately every 25 ms.

AMUTE

AMUTE is HIGH when \overline{HOLD} is LOW during clock display.

MW/LW

MW/LW is HIGH when in LW mode, and LOW when in MW mode.

IFCNT, SCANCONT

When SD is HIGH, IFCNT goes HIGH to turn the IF count buffer ON during an auto-search, and is LOW otherwise.

SCANCONT goes HIGH during the diode matrix scan following LOW-to-HIGH transition on \overline{HOLD} .

APS, LOC, LOUD, MTL, MO/ST, NR1 and NR2

APS, LOC, LOUD and MTL are HIGH when the corresponding LCD segments—APS, LOC, LOUD and MTL, respectively—are ON. NR1 is HIGH when the DNR segment is ON and digit 1 displays 'b' in tape mode, and NR2, when the DNR segment is ON and digit 1 displays 'C'.

Note that LOC, LOUD, NR1 and NR2 are active only when \overline{HOLD} is HIGH and during the power-on sequence.

The LOC segment is ON during a seek or scan search in Radio mode. The NR2 output is only active if the NRC diode is connected.

When in FM, VF ON radio modes or Radio Monitor mode, MO/ST is HIGH when the ST segment is OFF, and LOW, when it is ON.

\overline{R} , \overline{T} , \overline{C} , AM/FM, VFOUT, MW/LW and CDOUT

\overline{R} , \overline{T} and \overline{C} go LOW when the signal source is a radio, tape and CD, respectively. These open-drain outputs require pull-up resistors.

AM/FM is HIGH for AM band reception, and LOW, for FM band reception.

VFOUT is the VF control output.

MW/LW is the MW and LW bandswitching control output. MW/LW is LOW for the MW band, and HIGH for the LW band.

CDOUT is the CD power supply switch.

The state of the outputs in each operating mode are shown in table 2.

Table 2. Source selection

Mode			Source select outputs						
			\overline{R}	\overline{T}	\overline{C}	AM/FM	VF/ML	CDOUT	
VF OFF	Normal	Radio	LOW	HIGH	HIGH	LOW or HIGH	LOW	LOW	
		Tape	HIGH	LOW	HIGH	LOW or HIGH	LOW	LOW	
		CD	HIGH	HIGH	HIGH	LOW or HIGH	LOW	HIGH	
VF ON	DK standby	SK ON	Radio	LOW	HIGH	HIGH	LOW	HIGH	LOW
			Tape	HIGH	LOW	HIGH	LOW	HIGH	LOW
			CD	HIGH	HIGH	HIGH	LOW	HIGH	HIGH
		PS Scan	Radio	LOW	HIGH	HIGH	LOW	HIGH	LOW
			Tape	LOW	HIGH	HIGH	LOW	HIGH	LOW
			CD	LOW	HIGH	HIGH	LOW	HIGH	HIGH
	SK ON, Radio Monitor ON	Radio	LOW	HIGH	HIGH	LOW	HIGH	LOW	
		Tape	LOW	HIGH	HIGH	LOW	HIGH	LOW	
		CD	LOW	HIGH	HIGH	LOW	HIGH	HIGH	
	DK ON	Radio	LOW	HIGH	HIGH	LOW	HIGH	LOW	
		Tape	LOW	HIGH	HIGH	LOW	HIGH	LOW	
		CD	LOW	HIGH	HIGH	LOW	HIGH	HIGH	

LCTR, DK

The LCTR input signal should be ac-coupled and have a 100 mV minimum level. The counter error at MW and LW frequencies is ± 3 and ± 0.6 kHz, respectively. See the IFCOUNT 0 and IFCOUNT 1 diode-matrix connections description.

The controller measures the LCTR frequency at one-second intervals to determine if it is a DK signal, as shown in figure 15. If the frequency over a 386 ms period is 125 ± 10 Hz in three consecutive measurements, it is a valid DK signal.

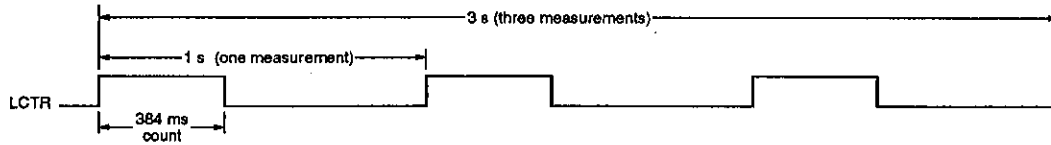

Figure 15. LCTR frequency measurement timing

FMIN, AMIN

The FMIN and AMIN input signals should be ac-coupled and have a 100 mVrms minimum level.

Control Matrix

The layout of the control matrix, which comprises key-matrix, transistor-matrix and diode-matrix sections, is shown in table 3. The function of the matrix elements is explained in the following sections.

EO1 and EO2

EO1 and EO2 connect to the lowpass filter in their respective PLL circuits.

Table 3. Key, diode and transistor matrix

Output	Input			
	K0	K1	K2	K3
T0	LOUD	M1	M2	M3
T1	MO/ST	M4, APS	M5, NR	M6, MTL
T2	VF	DOWN	UP	SCAN UP
T3	BAND	SEEK DOWN	SEEK UP	CD
T4	LOC	HA, APS	MA, NR	PS, AMEM
T5	DISPLAY (+Δ)	RMON	POWER	ME (Δ)
T6	TAPE (■)	CDIN (■)	FF (■)	REW (■)
T7	CLOCK (▲)	CD SELECT (▲)	SKIN (■)	DKIN (■)
T8 (MTL)	B0 (▲)	B1 (▲)	B2 (▲)	IFSHIFT (▲)
T9 (APS)	FMB0 (▲)	FMB1 (▲)	LW1 (▲)	LW2 (▲)
T10 (NR1)	NR C (▲)	MEMORY TYPE (▲)	POWER SW (▲)	PRIORITY (▲)
T11 (LOC/NR2)	IF COUNT0 (▲)	IF COUNT1 (▲)	COLON (▲)	VF AUTORETUNE (▲)
T12 (VFOU)	DOUBLE FUNCTION 0 (▲)	DOUBLE FUNCTION 1 (▲)	DOUBLE FUNCTION 2 (▲)	VF SELECT (▲)
T13 (LOUD)	REMOCON (▲)	DK COUNT (▲)	ANTI THEFT (▲)	POWER OFF, CLOCK ON (▲)
T14 (CDOU)	TAPE IND (▲)	FKEY0 (▲)	FKEY1 (▲)	DIR DISPLAY (▲)

Notes

No Momentary switch symbol



■ Transistor-matrix element

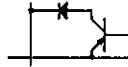

▲ Diode-matrix element

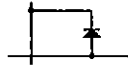

△ Diode and momentary switch

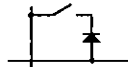

* Use a momentary switch for **DISPLAY** when the **ME** key is present.

Diode matrix

CLOCK

When the diode is connected, the clock display is disabled when $\overline{\text{HOLD}}$ is LOW, and the controller enters BACKUP mode. When it is not connected, the clock display remains enabled when $\overline{\text{HOLD}}$ is LOW, and the controller enters HOLD mode.

The display uses a 12-hour clock for the U.S.A., Japan, Saudi Arabia and South Africa, and a 24-hour clock for Eastern and Western Europe.

Table 4. Frequency band selection

Region	Band	Frequency range (FM:MHz, AM:kHz)	FREF (kHz)	Step frequency (kHz)	IF frequency (FM:MHz, AM:kHz)	IF count tolerance (kHz)	Diode matrix connections					
							B2	B1	B0	LW2	LW1	IFSHIFT
U.S.A.	FM a	87.5 to 107.9	50	200	10.7	±10	0	0	0	0	0	0
	MW a	530 to 1720	10	10	450	±3	0	0	0	0	0	0
	FM a	87.5 to 107.9	50	200	10.7	±10	0	0	0	0	0	1
	MW b	530 to 1620	10	10	450	±3	0	0	0	0	1	0
	FM a	87.5 to 107.9	50	200	10.7	±10	0	0	0	0	1	0
	MW c	531 to 1620	9	9	450	±3	0	0	0	0	1	1
	FM a	87.5 to 107.9	50	200	10.7	±10	0	0	0	0	1	1
	MW d	531 to 1719	9	9	450	±3	0	0	0	0	1	1
	FM b	87.5 to 108.0	50	100	10.7	±10	0	0	0	1	0	0
	MW a	530 to 1720	10	10	450	±3	0	0	0	1	0	0
	FM b	87.5 to 108.0	50	100	10.7	±10	0	0	0	1	0	1
	MW b	530 to 1620	10	10	450	±3	0	0	0	1	1	0
	FM b	87.5 to 108.0	50	100	10.7	±10	0	0	0	1	1	0
	MW c	531 to 1620	9	9	450	±3	0	0	0	1	1	0
FM b	87.5 to 108.0	50	100	10.7	±10	0	0	0	1	1	1	
MW d	531 to 1719	9	9	450	±3	0	0	0	1	1	1	

CD SELECT

When the diode is connected, the CD functions are enabled. If $\overline{\text{CDIN}}$ is taken LOW, $\overline{\text{CDOU}}$ goes HIGH. When the diode is not connected, the CD functions are disabled, $\overline{\text{CDIN}}$ is ignored and $\overline{\text{CDOU}}$ is held LOW.

B0 to B2, LW1, LW2 and IFSHIFT

These diode matrix connections are used to select the radio frequency bands as shown in table 4.

Table 4. Frequency band selection—continued

Region	Band	Frequency range (FM:MHz, AM:kHz)	FREF (kHz)	Step frequency (kHz)	IF frequency (FM:MHz, AM:kHz)	IF count tolerance (kHz)	Diode matrix connections					
							B2	B1	B0	LW2	LW1	IFSHIFT
Western Europe	FM c	87.5 to 108.0	25	50	10.7	±10	0	0	1	0	0	0 or 1
	MW e	522 to 1620	9	9	450 or 459	±3				0	1	
	LW a	153 to 281	1	1 (9)	450 or 459	±0.6				0	1	
	FM c	87.5 to 108.0	25	50	10.7	±10	0	1	0	0	0	0 or 1
	MW o	531 to 1620	9	9	450 or 459	±3				0	1	
	LW a	153 to 281	1	1 (9)	450 or 459	±0.6				0	1	
	FM d	87.5 to 108.0	12.5	25	10.7	±10	0	1	1	0	0	0 or 1
	MW e	522 to 1620	9	9	450 or 459	±3				0	1	
	LW a	153 to 281	1	1 (9)	450 or 459	±0.6				0	1	
	FM d	87.5 to 108.0	12.5	25	10.7	±10	1	0	0	0	0	0 or 1
	MW c	531 to 1620	9	9	450 or 459	±3				0	1	
	LW a	153 to 281	1	1 (9)	450 or 459	±0.6				0	1	
	FM c	87.5 to 108.0	25	50	10.7	±10	0	0	1	0	0	0 or 1
	MW e	522 to 1620	9	9	450 or 459	±3				1	0	
	LW b	146 to 280	1	1 (9)	450 or 459	±0.6				0	0	
	FM c	87.5 to 108.0	25	50	10.7	±10	0	1	0	0	0	0 or 1
	MW c	531 to 1620	9	9	450 or 459	±3				1	0	
	LW b	146 to 290	1	1 (9)	450 or 459	±0.6				0	0	
	FM d	87.5 to 108.0	12.5	25	10.7	±10	0	1	1	0	0	0 or 1
	MW e	522 to 1620	9	9	450 or 459	±3				1	0	
LW b	146 to 290	1	1 (9)	450 or 459	±0.6	0				0		
FM d	87.5 to 108.0	12.5	25	10.7	±10	1	0	0	0	0	0 or 1	
MW c	531 to 1620	9	9	450 or 459	±3				1	0		
LW b	146 to 290	1	1 (9)	450 or 459	±0.6				0	0		
Japan	FM e	76.0 to 90.0	50	100	-10.7	±10	1	0	1	0	0	0
	MW f	522 to 1629	9	9	450	±3				0	0	
Saudi Arabia	FM b	87.5 to 108.0	50	100	-10.7	±10	1	0	1	0	0	1
	MW g	531 to 1602	9	9	450	±3				0	0	
South Africa	FM f	87.5 to 108.0	50	100	-10.7	±10	1	0	1	0	1	0
	MW g	531 to 1602	9	9	450	±3				0	0	
Eastern Europe	FM g	64.0 to 108.0	25	50	10.7	±10	1	0	1	1	0	0
	MW h	522 to 1620	9	9	450	±3				0	0	

Notes

- 0 = no diode connected
- 1 = diode connected
- The IFSHIFT diode matrix connection selects the IF frequency.
- Step frequencies in parentheses indicate the auto-tuning frequency step when IF count is not operating.

FMB0 and FMB1

The number of preset FM stations is selected using FMB0 and FMB1 as shown in table 5.

Table 5. Preset FM stations

FMB1	FMB0	FM bands	Preset stations
0	0	FM1, FM2, FM3	18
0	1	FM1, FM2	12
1	0	FM1	6
1	1	Illegal	

Notes

0 = no diode connected
 1 = diode connected

Dolby C NR

When the diode is connected, Dolby type C noise reduction is enabled, and pressing the **NR** key cycles the noise reduction mode between the OFF, Dolby B NR and Dolby C NR states. When it is not connected, Dolby C NR is disabled, and pressing the **NR** key toggles the noise reduction mode between the OFF and Dolby B NR states.

The output and LCD display states are shown in table 6. The noise reduction mode is displayed using digit 1 of the LCD panel.

Table 6. Noise reduction modes

Mode	Display		Output	
	DNR Indicator	Digit 1	NR1	NR2
OFF	OFF	OFF	LOW	LOW
NR B	ON	b	HIGH	LOW
NR C	ON	c	LOW	HIGH

MEMORY TYPE

This diode connection selects which of two procedures is used for storing preset frequencies when in Radio mode. See the description of the **M1** to **M6** and **ME** key functions for further information.

POWER SW

When the diode is connected, the **POWER** key controls controller power-ON and power-OFF. When the diode is not connected, the logic level of **HOLD** controls controller power-ON and power-OFF. See the **POWER** key description for further information.

PRIORITY

The PRIORITY diode-matrix connection is only active when the **CLOCK** diode is not connected so that the clock display is enabled. When the PRIORITY diode is connected, the radio, tape and CD displays have priority over the clock display, and when the diode is not connected, the clock display has priority.

IFCOUNT0 and IFCOUNT1

These diode-matrix connections determine the HCTR and LCTR modes as shown in table 7.

Table 7. Counter modes

IFCOUNT1	IFCOUNT0	HCTR	LCTR
0	0	FM IF	AM IF
0	1	AM IF	DK
1	0	GND	DK
1	1	FM IF or AM IF	DK

Note

0 = no diode connected
 1 = diode connected

When IFCOUNT0 is not connected and IFCOUNT1 is connected, HCTR is disabled and should be tied to GND. In addition, the LW seek function seeks in 9 kHz steps. When IFCOUNT0 and IFCOUNT1 are both connected, HCTR is the AM IF and FM IF input from an external IF-stage IC.

COLON

When the diode is connected, the clock colon flashes at 1 Hz, and when not connected, the colon is constantly ON.

VF AUTORETUNE

VF AUTORETUNE selects the retuning operation in VF ON mode when **SKIN** is HIGH for greater than 30 s. If the diode is not connected, ALARM goes HIGH and retuning occurs, and if it is connected, no action is taken.

VF SELECT

When the diode is connected, VF mode is enabled, and when not connected, disabled.

REMOCON

When the diode is connected, the remote control input is enabled, and when not connected, disabled.

DK COUNT

When the diode is connected, the LCTR DK count function is disabled. In this case, the DK signal detected

by an external IC should be used as the dc input to the $\overline{\text{DKIN}}$ transistor-matrix element. When the diode is not connected and the controller is in VF ON mode, the LCTR DK count function is enabled.

ANTI-THEFT

When the diode is connected, the anti-theft function is disabled, and when not connected, enabled.

POWER-OFF CLOCK ON

POWER-OFF CLOCK ON is only active when the POWER SW diode is connected. When the POWER-OFF CLOCK ON diode is connected, clock display is enabled while the **POWER** key is OFF, and when it is not connected, disabled.

DIR DISPLAY

When the diode is connected, the tape direction display function is disabled, and when not connected, enabled.

The tape direction display uses the $\overline{\text{FF}}$ and $\overline{\text{REW}}$ transistor matrix elements and arrow segments in the LCD panel as shown in table 8.

Table 8. Tape direction display

Mode	$\overline{\text{FF}}$	$\overline{\text{REW}}$	Direction	
			Forward	Reverse
Play	HIGH	HIGH		
Rewind	HIGH	LOW	 Flashes at 2 Hz	 Flashes at 2 Hz
Fast forward	LOW	HIGH	 Flashes at 2 Hz	 Flashes at 2 Hz

TAPE IND

When the diode is connected and the controller is in Tape mode, the LCD panel indicates the tape direction as shown in figures 16 and 17. Starting with the segment indicated by the upward arrow, the OFF segment rotates in the direction of the arrow through the four positions every 0.5 s for play and every 125 ms for fast-forward or rewind modes. The rotation is anti-clockwise for play or fast-forward in the forward direction and rewind in the reverse direction, and clockwise, for play or fast-forward in the reverse direction and rewind in the forward direction.



Figure 16. Anti-clockwise tape direction display



Figure 17. Clockwise tape direction display

When the diode is not connected, the display in Tape mode is as shown in figure 18.



Figure 18. Tape mode display

DOUBLE FUNCTION0 to DOUBLE FUNCTION2

These diode connections select the **M4** to **M6** key functions in Tape mode. See the **M1** to **M6** and **ME** functional description for further information.

FKEY0 and FKEY1

These diode connections select the **HA** and **MA** key functions in Tape mode. See the **HA** and **MA** functional description for further information.

Transistor matrix

$\overline{\text{CDIN}}$ and $\overline{\text{TAPE}}$

$\overline{\text{CDIN}}$ and $\overline{\text{TAPE}}$ are used to set the operating mode. When $\overline{\text{CDIN}}$ is LOW, CD mode is selected, and when $\overline{\text{CDIN}}$ is HIGH and $\overline{\text{TAPE}}$ is LOW, Tape mode is selected. When both $\overline{\text{CDIN}}$ and $\overline{\text{TAPE}}$ are HIGH, Radio mode is selected.

$\overline{\text{FF}}$ and $\overline{\text{REW}}$

$\overline{\text{FF}}$ and $\overline{\text{REW}}$ select the tape mode, which determines the tape direction display and the tape indication display. Play mode is selected when $\overline{\text{FF}}$ and $\overline{\text{REW}}$ are both HIGH, fast-forward mode, when $\overline{\text{FF}}$ is LOW and $\overline{\text{REW}}$ is HIGH, and rewind mode, when $\overline{\text{FF}}$ is HIGH and $\overline{\text{REW}}$ is LOW.

$\overline{\text{SKIN}}$

When in VF ON mode and the tuner is using an FM band, the SK LCD segment turns ON when $\overline{\text{SKIN}}$ is taken LOW. Pressing the **VF** key while $\overline{\text{SKIN}}$ is LOW initiates a frequency-band search.

If $\overline{\text{SKIN}}$ remains LOW for approximately 250 ms after SD goes HIGH, the tuner holds the new frequency. SD

is checked every 25 ms, and if it remains HIGH for greater than 30 s, the controller initiates an auto-tune operation. If the new frequency does not match any of the preset frequencies, the controller continues the frequency-band search until the next frequency at which $\overline{\text{SKIN}}$ goes LOW.

$\overline{\text{DKIN}}$

$\overline{\text{DKIN}}$ is active only when the LCTR function is disabled, a European radio band is selected and the controller is in VF ON mode and either Tape or CD mode. When $\overline{\text{DKIN}}$ is brought LOW three times in succession, 25 ms apart, the controller switches to Radio mode to receive ARI broadcasts. This DK count check is also performed 3 s after an SK SEEK operation finds a frequency at which $\overline{\text{DKIN}}$ goes LOW.

Key Functions

M1 to M6 and ME

When in Radio mode, these keys are used for storing and recalling preset frequencies. The storage procedure is selected using the MEMORY TYPE diode connection.

When the diode is not connected, pressing a memory key (M1 to M6) for greater than 1.5 s stores the current frequency. Pressing the key for less time recalls the stored frequency. When the diode is connected, pressing the ME key enables storage and the 'P' preset channel indicator flashes at 2 Hz. Pressing a memory key within 5 s stores the current frequency. Pressing any other key or a HIGH-to-LOW transition on $\overline{\text{HOLD}}$ within the five-second interval disables storage.

When in Tape mode, M4 to M6 are used as tape function keys. The key functions are selected using the DOUBLE FUNCTION0 to DOUBLE FUNCTION2 diode-matrix connections as shown in table 9.

Table 9. Memory key functions in TAPE mode

DOUBLE FUNCTION2	DOUBLE FUNCTION1	DOUBLE FUNCTION0	M4	M5	M6
0	0	0	APS	NR	MTL
0	0	1	-	-	-
0	1	0	-	APS	MTL
0	1	1	-	-	MTL
1	0	0	-	-	APS
1	0	1	-	-	NR

Table 9. Memory key functions in TAPE mode—continued

DOUBLE FUNCTION2	DOUBLE FUNCTION1	DOUBLE FUNCTION0	M4	M5	M6
1	1	0	-	NR	MTL
1	1	1	-	APS	NR

Notes

- = not used
- 0 = no diode connected
- 1 = diode connected

When in VF mode and Radio or Tape modes, the memory keys function as tuner keys.

When in clock-display mode, if the MEMORY TYPE diode is connected, pressing the ME key together with the HA or MA key (or their equivalents, M1 and M2) changes the time. Changing the time is only possible when $\overline{\text{HOLD}}$ is HIGH and during the power-on sequence.

HA and MA

When in clock-display mode, HA (or its equivalent, M1) is used as the hour adjust key, and MA (or M2), as the minute adjust key. They are used in combination with the ME key or, if that key is not available, with the DISPLAY key. A single press increments the hour or minute field once. Pressing for longer than 500 ms causes the field to increment four times per second.

Using either key automatically resets the second field to 00. There is no overflow from the minute adjustment into the hour field.

When in Tape mode, HA and MA are used as tape function keys. The key functions are selected using the FKEY0 and FKEY1 diode-matrix connections as shown in table 10.

Table 10. HA and MA key functions in TAPE mode

FKEY1	FKEY0	HA	MA
0	0	-	-
0	1	APS	NR
1	0	MTL	NR
1	1	APS	-

Notes

- = not used
- 0 = no diode connected
- 1 = diode connected

SEEK UP and SEEK DOWN

SEEK UP and **SEEK DOWN** are used to initiate station seek in the upward and downward directions, respectively. The seek speed is 50 ms/step for FM and 70 ms/step for AM. The controller pauses for 500 ms between bands. The station seek is halted when a station is detected. If the key for the opposite direction is pressed during seek, the seek reverses direction. If a seek key is pressed twice in succession, seek mode is deselected.

If the **SCAN** key is pressed during seek, scan mode is selected and operation continues.

SEEK UP and **SEEK DOWN** are only active when **HOLD** is HIGH and during the power-on sequence.

SCAN

SCAN is used to switch the station search function between seek and scan modes. During scan, the controller pauses for 5 s on each station, holding **AMUTE** HIGH, and waits for a second press of the **SCAN** key. If the key is not pressed during the pause, the search function resumes searching in the current direction. Pressing **SCAN** at any other time returns the search function to seek mode. The scan speed is 50 ms/step for FM and 70 ms/step for AM. The controller pauses for 500 ms between bands.

This key is only active when **HOLD** is HIGH and during the power-on sequence.

UP and DOWN

When in Radio mode, these keys are used for manual tuning. A single press of **UP** or **DOWN** increments or decrements, respectively, the frequency display by one step. Pressing for longer than 500 ms causes the frequency to increment or decrement approximately once every 70 ms. At the edges of the frequency band, the

display automatically switches to the opposite edge after waiting approximately 500 ms.

These keys are only active when **HOLD** is HIGH and during the power-on sequence.

BAND

Pressing this key cycles the tuner through the available frequency bands as shown in figure 19.

This key is only active when **HOLD** is HIGH and during the power-on sequence.

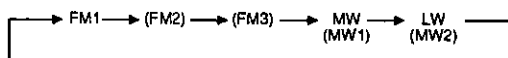

Figure 19. Frequency band sequence

Note

Optional frequency bands are shown in parentheses.

VF

When in Radio mode, pressing **VF** selects VF ON mode, where the FM band is selected, the VF indicator turns ON and VFOUT goes HIGH. After 300 ms, the controller checks that SD is HIGH, and after a further 250 ms, or 750 ms if the band was changed, it checks the **SKIN** logic level. If **SKIN** is LOW, it maintains the current frequency, and if HIGH, it automatically searches for an SK station, that is, a frequency at which **SKIN** goes LOW.

The **VF**, **SEEK UP**, **SEEK DOWN** keys and **SKIN** input functions in VF OFF and VF ON modes are shown in table 11.

Table 11. **VF**, **SEEK UP**, **SEEK DOWN** and **SKIN** functions

VF mode	SKIN	VF is pressed	SEEK UP or SEEK DOWN is pressed	The same seek key is pressed during a search	VF is pressed during a search
OFF	HIGH	Select VF ON mode and start search for an SK station.	Start search for a normal station.	Stop search at current frequency.	Select VF ON mode and start search for an SK station.
OFF	LOW	Select VF ON mode.	Start search for a normal station.	Stop search at current frequency.	Select VF ON mode and start search for an SK station.
ON	×	Select VF OFF mode.	Start search for an SK station.	Continue the search.	Select VF OFF mode and return tuner to the previous state.

Note

× = don't care

If the controller is in Radio Monitor mode, pressing **VF** function and initiates the step 1 and step 2 operations to initiate VF ON mode disables the radio monitor shown in table 12.

Table 12. Operation when **VF** is pressed in Tape and CD modes

Step No.	SKIN	DKIN is pressed	Operation	Mode	R̄	T̄	C̄	AM/FM
1	HIGH	HIGH	The frequency display appears while the tuner searches for a higher frequency at which SKIN is LOW, but changes back to the Tape or CD mode display at the end of the search. If DKIN is LOW, go to step 3.	Tape	HIGH	LOW	HIGH	LOW
				CD	HIGH	HIGH	LOW	LOW
2	LOW	HIGH	The Tape or CD mode display remains. If DKIN is LOW, go to step 3. If the AUTO RETUNE diode is not connected and SKIN goes HIGH within 30 seconds, the controller initiates an auto-retune operation. If the frequency does not match one of those stored with M1 to M6, the controller searches for a higher frequency at which SKIN goes LOW.	Tape	HIGH	LOW	HIGH	LOW
				CD	HIGH	HIGH	LOW	LOW
3	LOW	LOW	The frequency display appears and ARI reception begins.		LOW	HIGH	HIGH	LOW

Note

Valid when **HOLD** is HIGH and during power-on.

- No products described or contained herein are intended for use in surgical implants, life-support systems, aerospace equipment, nuclear power control systems, vehicles, disaster/crime-prevention equipment and the like, the failure of which may directly or indirectly cause injury, death or property loss.
- Anyone purchasing any products described or contained herein for an above-mentioned use shall:
 - ① Accept full responsibility and indemnify and defend SANYO ELECTRIC CO., LTD., its affiliates, subsidiaries and distributors and all their officers and employees, jointly and severally, against any and all claims and litigation and all damages, cost and expenses associated with such use:
 - ② Not impose any responsibility for any fault or negligence which may be cited in any such claim or litigation on SANYO ELECTRIC CO., LTD., its affiliates, subsidiaries and distributors or any of their officers and employees jointly or severally.
- Information (including circuit diagrams and circuit parameters) herein is for example only; it is not guaranteed for volume production. SANYO believes information herein is accurate and reliable, but no guarantees are made or implied regarding its use or any infringements of intellectual property rights or other rights of third parties.

Pressing **VF** or the **BAND** key deactivates VF ON mode. The **BAND** key is not available, however, when **TAPE** is LOW, the CD is ON or the controller is in

Radio Monitor mode. The VF mode flowchart is shown in figure 20.

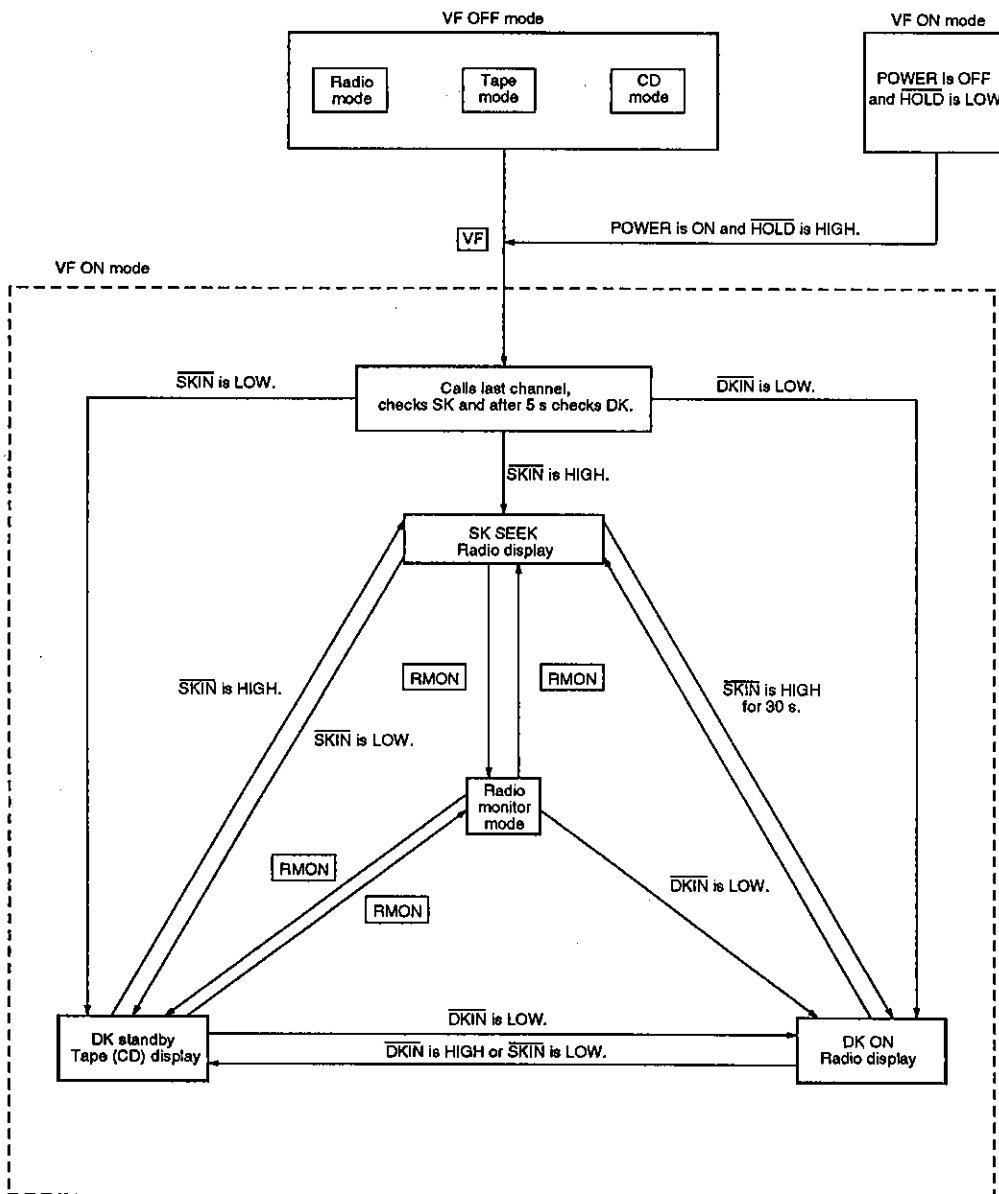

Figure 20. VF mode flowchart

Notes

1. A HIGH-to-LOW transition on \overline{DKIN} cancels Radio Monitor mode.
2. Key labels are shown surrounded by boxes.
3. Changing from VF ON to VF OFF mode cancels Radio Monitor mode.

PS/AMEM

If pressed for less than 2 s, this key functions as the preset scan (PS) key, or if pressed for longer, as the auto-store memory (AMEM) key.

Preset scan

The preset channels are scanned in increasing order from the current channel, or from channel 1 if there is no channel number on the display. When a station is

detected, \overline{AMUTE} is held HIGH for 5 s and then the preset scan ends. During the scan, the channel number flashes at 1 Hz, and the LOC/DX setting is forced to DX.

Pressing one of **PS/AMEM**, **SEEK UP**, **SEEK DOWN**, **SCAN**, **UP**, **DOWN**, **M1** to **M6**, **POWER**, **BAND** or **VF** halts the preset scan, as does a HIGH-to-LOW transition on \overline{HOLD} or switching to the Tape or CD modes.

The preset scan frequency band sequence, shown in figure 21, is determined by the FMB0, FMB1 and B0 to B2 diode-matrix connections.

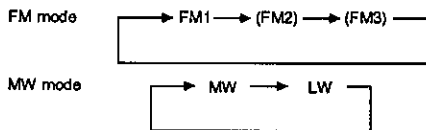

Figure 21. Preset scan sequence

Auto-store memory

In the FM bands, this function scans the starting and higher frequency bands and stores the six stations in each band with the strongest field strengths under memory keys **M1** to **M6**. The number of stored stations depends on the number of bands available, which is determined by the FMB0 and FMB1 diode-matrix connections and the starting band.

When both the FMB0 and FMB1 diodes are not connected, the FM1, FM2 and FM3 bands are available.

- Starting from FM1 stores 18 stations as **M1** to **M6** for each of FM1, FM2 and FM3.
- Starting from FM2 stores 12 stations as **M1** to **M6** for FM2 and FM3.
- Starting from FM3 stores six stations as **M1** to **M6** for FM3.

When FMB0 is connected and FMB1 is not connected, the FM1 and FM2 bands are available.

- Starting from FM1 stores 12 stations as **M1** to **M6** for FM1 and FM2.
- Starting from FM2 stores six stations as **M1** to **M6** for FM2.

When FMB0 is not connected and FMB1 is connected, only the FM1 band is available.

- Starting from FM1 stores six stations as **M1** to **M6** for FM1.

When the VF SELECT diode is connected, the VF band is available.

- Starting from the VF band stores six stations as **M1** to **M6** for VF.

In the MW and LW bands, the controller sets LOC HIGH and stores stations in Local mode. If there are less than six stations, it then sets LOC LOW and continues in the DX mode. When there is no LW band and two MW bands, MW1 and MW2 are available.

- Starting from MW1 stores 12 stations as **M1** to **M6** for MW1 and MW2
- Starting from MW2 stores six stations as **M1** to **M6** for MW2.

During the auto-store operation, the channel number flashes at 1 Hz.

If less than six stations are found in a frequency band, the preset frequencies of the unused memory keys remain unchanged. At the end of the scan, the controller automatically selects channel 1.

Pressing one of **PS/AMEM**, **POWER**, **BAND** or **VF** halts the auto-store operation, as does a HIGH-to-LOW transition on \overline{HOLD} or switching to Tape or CD modes.

CD

Pressing this key selects CD mode. The controller sets CDOUT HIGH and displays 'CD' on the LCD panel as shown in figure 22.



Figure 22. CD mode display

This key is only active when \overline{HOLD} is HIGH and during the power-on sequence. It does not operate when \overline{CDIN} is LOW.

CD mode has the highest priority. CD mode is cancelled by forcing a HIGH-to-LOW-to-HIGH transition on \overline{HOLD} by turning the power OFF then ON again, for example.

LOC

Pressing this key when in Radio mode turns ON the LOC indicator. Subsequently pressing a **SEEK** key or the **SCAN** key sets the LOC output HIGH and starts a local search. The LOC output goes LOW again when the search ends.

This key is only active when \overline{HOLD} is HIGH and during the power-on sequence.

LOUD

Pressing this key toggles the states of the LOUD indicator and the LOUD output. When pressed once, the indicator turns ON and the output goes HIGH. When pressed again, the indicator turns OFF and the output goes LOW.

This key is only active when \overline{HOLD} is HIGH and during the power-on sequence.

DISPLAY

When the CLOCK diode is not connected and the clock display is enabled, pressing this key toggles the LCD

panel between the clock display and the display for the current mode. The LCD panel automatically returns to the default display 5 s after the key is released, as shown

in table 13. When the PRIORITY diode is not connected, the clock display is the default, and when it is connected, the mode display is the default.

Table 13. DISPLAY functions

Mode	Priority display	
	Clock	Mode
Radio	<p>The RADIO keys are PS/AMEM, SEEK UP, SEEK DOWN, SCAN, UP, DOWN, M1 to M6, POWER, BAND, VF and LOC.</p>	<p>Pressing a RADIO key during the clock display returns the LCD panel to the frequency display.</p>
Tape	<p>Inserting a tape also activates the Tape mode display for five seconds.</p>	
CD	<p>Inserting a CD also activates the CD mode display for five seconds.</p>	
VF ON and CD or Tape	<p>Since the LCD panel always returns to the clock display, there is no way to monitor tape activity unless the DIR DISPLAY diode is not connected in which case the tape direction indicators are enabled.</p>	<p>There is no way to monitor tape activity during the frequency display unless the DIR DISPLAY diode is not connected in which case the tape direction indicators are enabled.</p>

This key is only active when $\overline{\text{HOLD}}$ is HIGH and during the power-on sequence.

When the MEMORY TYPE diode is not connected, this key is used in place of the **ME** key when adjusting the clock display.

RMON

Pressing this key when in Tape or CD mode selects the Radio Monitor mode. The RMON indicator flashes at

1 Hz and the controller temporarily selects the radio by holding $\overline{\text{R}}$ LOW and $\overline{\text{T}}$ and $\overline{\text{C}}$ HIGH. Pressing it again reselects the previous mode, turns the RMON indicator OFF and restores $\overline{\text{R}}$, $\overline{\text{T}}$ and $\overline{\text{C}}$ to their previous states.

This key has an alternative function in the VF ON mode. See the description of the **VF** key functions for further information.

This key is only active when $\overline{\text{HOLD}}$ is HIGH and during the power-on sequence.

POWER

When the POWER SW diode is connected and an alternate-action switch is used in the key matrix as shown in figure 23, this key controls power to the

controller. When the key is pressed, the POWER output is set HIGH. The Tape or CD mode can then be selected by setting TAPE or CDIN, respectively, LOW.

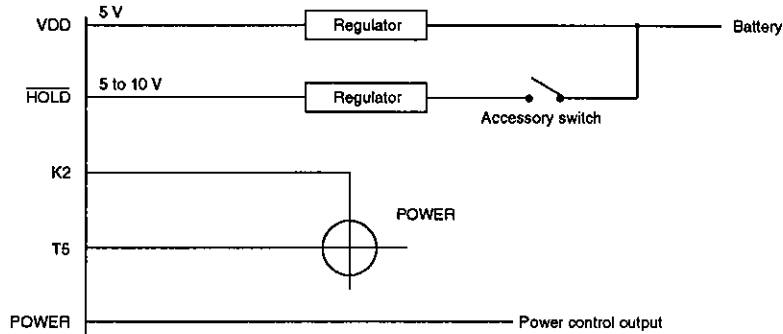

Figure 23. **POWER** key power supply configuration

When the POWER SW diode is not connected, the **POWER** key is not required and the power supply configuration shown in figure 24 should be used.

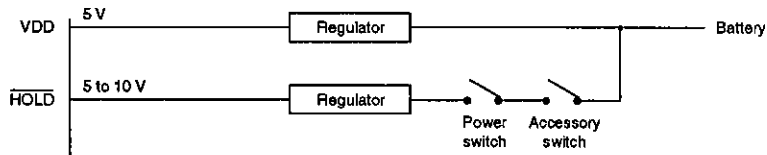

Figure 24. Power supply switch configuration

Remote Control

A remote control unit using the LC7461M-8103, as shown in figure 25, can duplicate the keypad functions.

The remote control unit key assignments are shown in table 14.

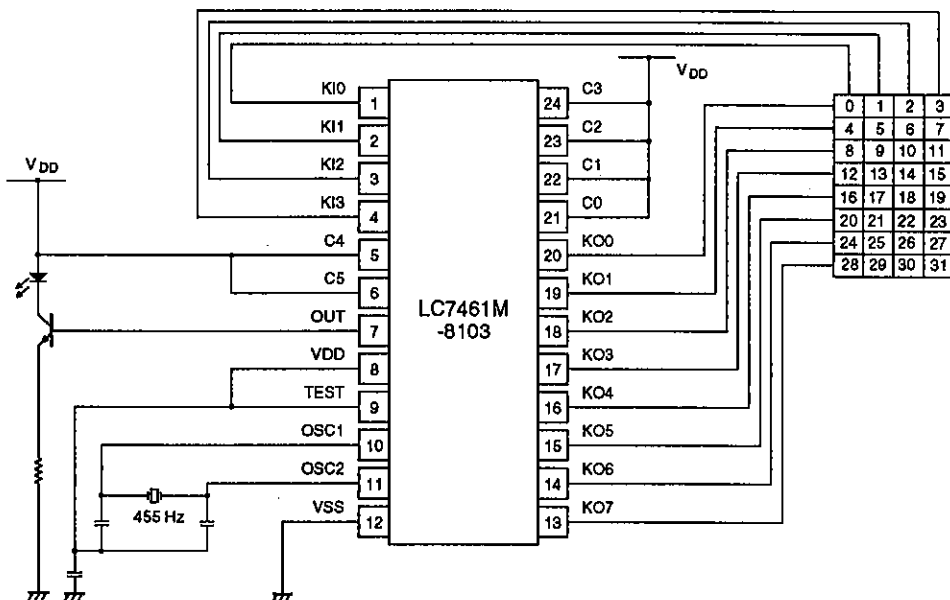

Figure 25. Remote control circuit

Table 14. Key matrix

Input	Output															
	K00		K01		K02		K03		K04		K05		K06		K07	
KI0	0	LOUD	4	MO/ST	8	VF	12	BAND	16	LOC	20	DISPLAY	24	-	28	-
KI1	1	M1	5	M4/MTL	9	DOWN	13	SEEK DN	17	APS	21	RMON	25	ADJ	29	-
KI2	2	M2	6	4	10	UP	14	SEEK UP	18	NR	22	POWER	26	HA	30	-
KI3	3	M3	7	M6/APS	11	SCAN UP	15	CD	19	PS/AMEM	23	ME	27	MA	31	-

Note

- = not used

Since the LC7461M-8103 does not support simultaneous key presses, pressing the **ME** key and then the memory key duplicates the **ME** key together with a memory key (**M1** to **M6**).

ADJ, **HA** and **MA** also operate differently from their microcontroller keypad equivalents, **HA** and **MA**.

Pressing **ADJ** activates a clock adjustment mode in which the entire clock display flashes and which can also be altered using the **HA** and **MA** keys. Pressing **ADJ** a second time deactivates this mode.

The remote control input is ignored when the anti-theft function is ON.

OPERATING INFORMATION

Operating Mode Flowcharts

VF ON mode, clock display disabled

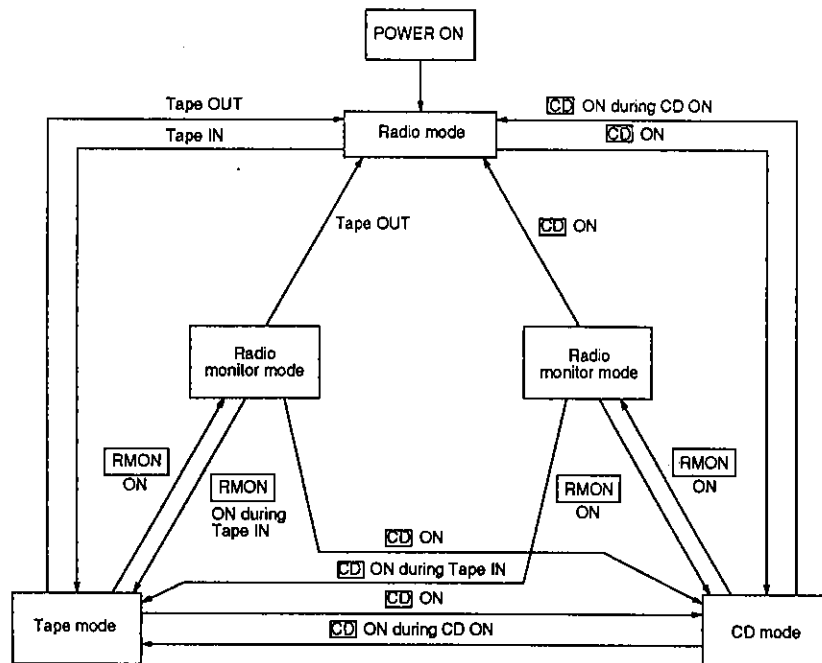

VF ON mode, clock display enabled

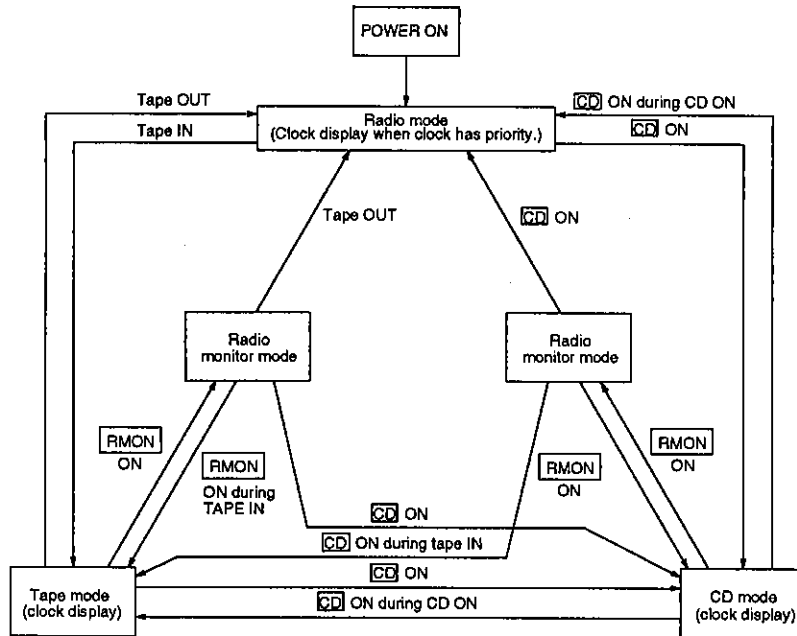

VF OFF mode, clock display disabled

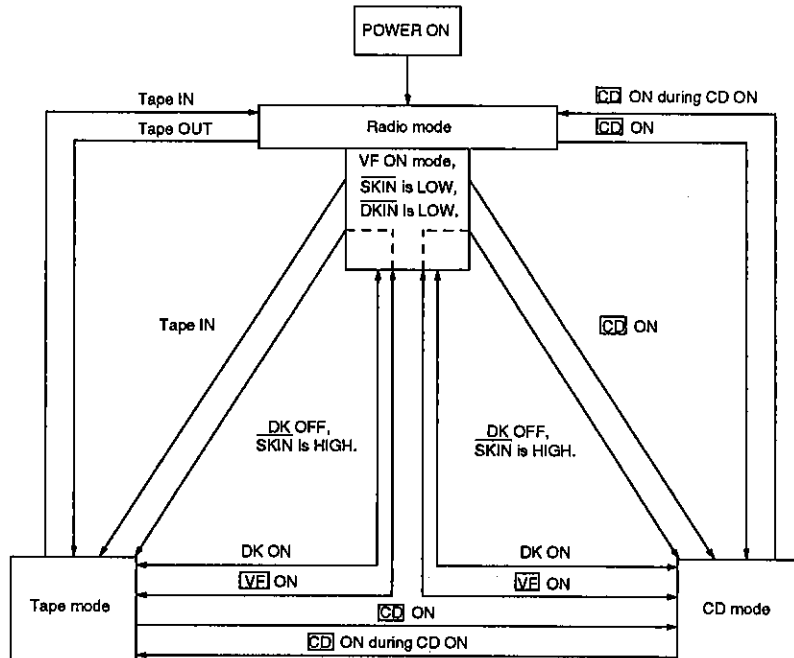

VF ON mode auto-retune

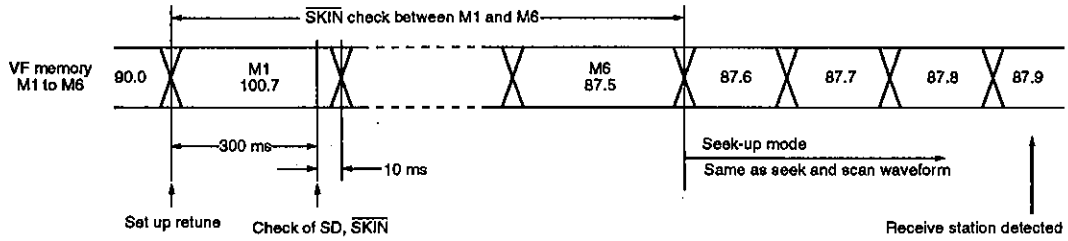

Note

The auto-retune takes place when $\overline{\text{SKIN}}$ is HIGH for greater than 30 s.

VF ON mode preset memory search

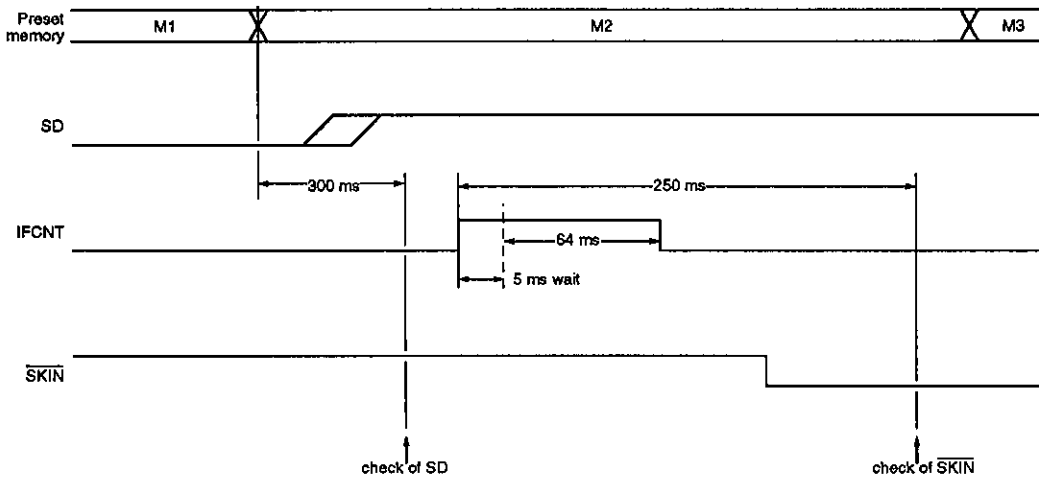

Note

If SD does not go HIGH at any of the preset frequencies, the controller then performs a normal seek operation.

LOC output

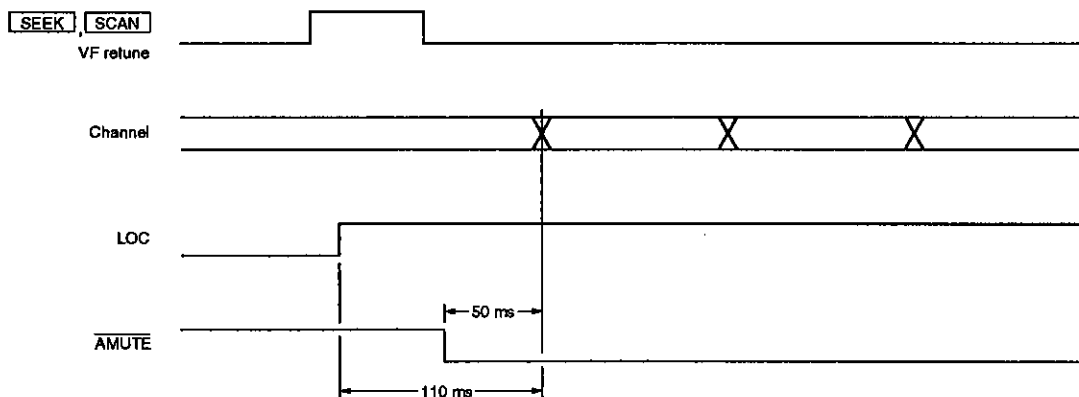

Note

The LOC indicator turns ON during seek, scan, AMEM and VF ON mode auto-retune operations.

SKIN check when changing from VF OFF to VF ON

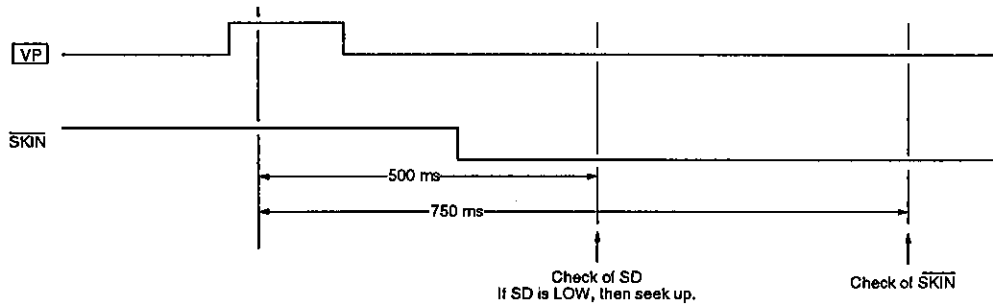

AMUTE

The numbers in the AMUTE (audio mute) output waveforms correspond to the following.

1. 40 ms key debounce interval
2. 50 ms audio muting lead time and BEEP output interval

3. 30 to 50 ms display PLL data change time
4. Audio muting hold time

Note that, except for the bandswitching figures, AMUTE does not go LOW as shown if the controller is in DK OFF mode, TAPE and CDIN are LOW and the CD is ON.

Bandswitching, preset reading and changing from VF ON to VF OFF mode



Bandswitching and changing from VF OFF to VF ON mode

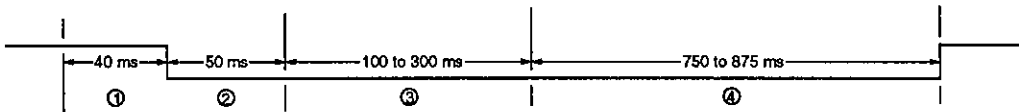

Notes

1. In DK OFF mode, when TAPE and CDIN are LOW and the CD is on.
2. Period 3 includes the SKIN check time.

Manual frequency change

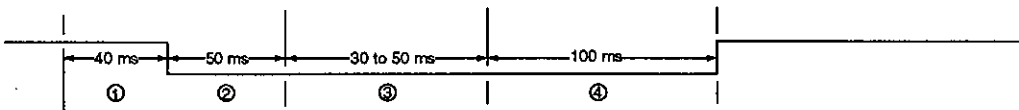

Preset scan

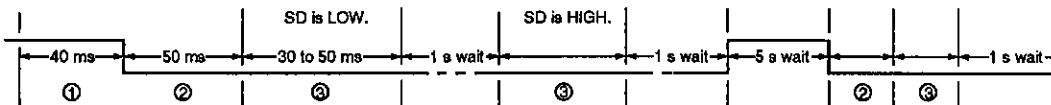

AMEM, seek and scan

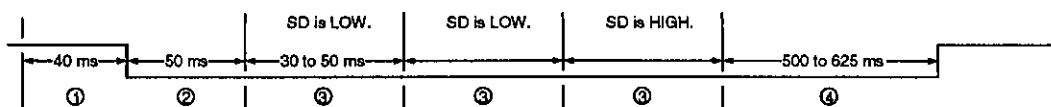

VF ON mode auto-retune

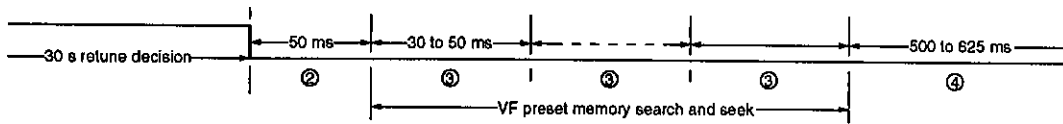

Mode change

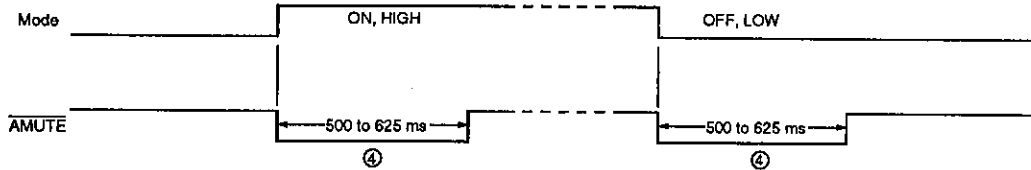

Note

Applies to the following mode changes.

- Radio mode ON
- Radio Monitor mode ON or OFF
- Tape in or out
- **CD** ON or OFF
- A HIGH-to-LOW-to-HIGH transition of \overline{CDIN} .

VF mode change

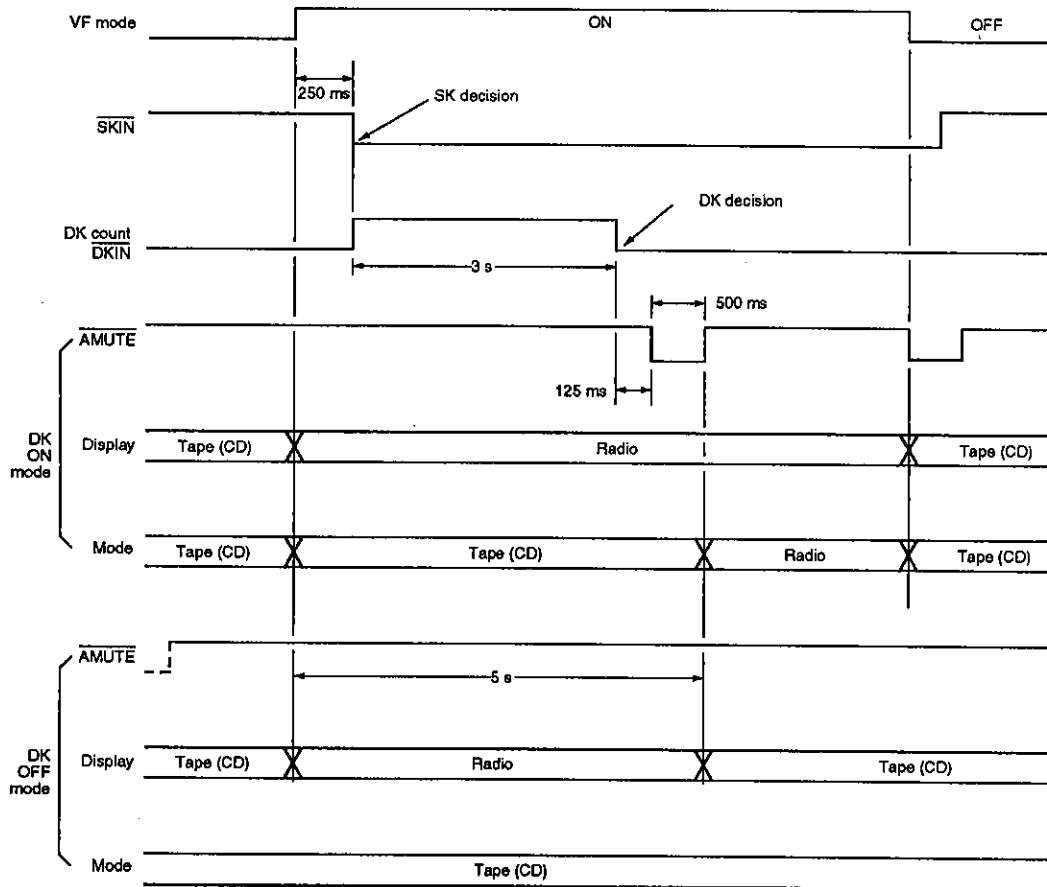

Note

Applies to a change from VF OFF to VF ON mode when in Tape or CD mode.

SKIN and STEREO

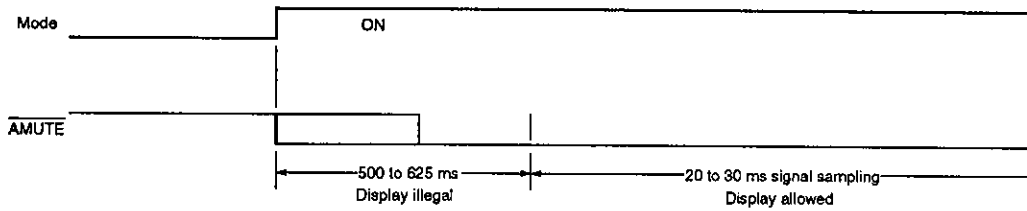

Note

The $\overline{\text{SKIN}}$ and $\overline{\text{STEREO}}$ waveforms following a mode change. Note that the SK indicator is controlled by the $\overline{\text{SKIN}}$ input, and the ST indicator, by the $\overline{\text{STEREO}}$ input.

SKIN and ALARM

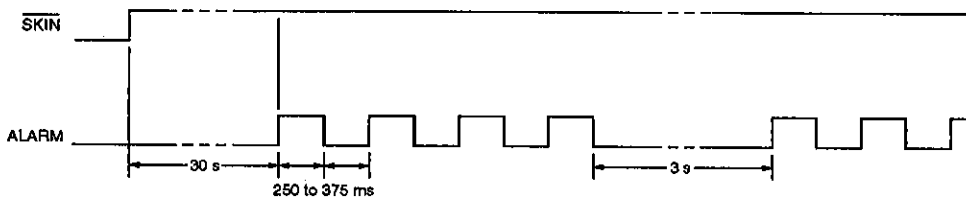

Note

The ALARM output waveform in VF ON mode when $\overline{\text{SKIN}}$ is HIGH for greater than 30 s.

HOLD and BACKUP modes

HOLD mode waveforms

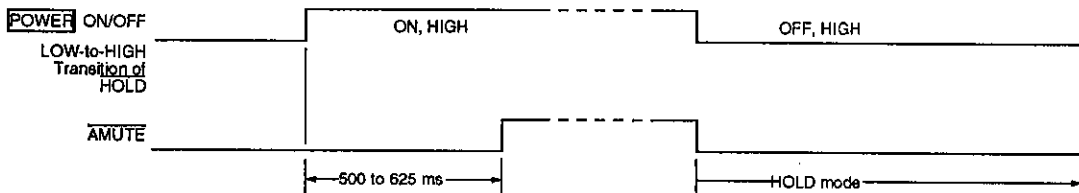

Note

The FMIN, AMIN, HCTR, LCTR and ADI inputs are ignored.

BACKUP mode waveforms

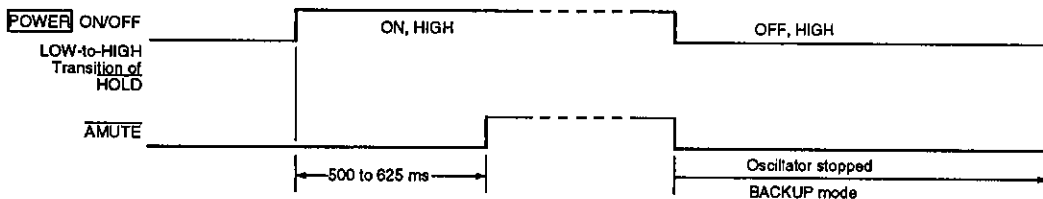

Notes

1. Note that the FMIN, AMIN, HCTR, LCTR and ADI inputs are ignored and that the 4.5 MHz crystal oscillator is stopped.
2. $\overline{\text{AMUTE}}$ goes high-impedance in BACKUP mode and requires an external, pull-down resistance to take it LOW.

Initial Operating Conditions

Mode	Variable	Initial state
Radio	Frequency and band	Low band edge in FM1 band
	MO/ST	Mono
	VF mode	OFF
	LOC/DX	DX
Tape	NR B	OFF
	NR C	OFF
	APS	OFF
	MTL	OFF
POWER is ON and HOLD is HIGH.	CD	OFF
	LOUD	OFF
	Radio Monitor mode	OFF

Tracking Point Frequencies

Region	Band	M1	M2	M3	M4	M5	M6	Last channel
U.S.A.	FM a,b	87.5	90.1	98.1	106.1	107.9	87.5	87.5
	MW a	530	600	1000	1400	1720	530	530
	MW b	530	600	1000	1400	1620	530	530
	MW c	531	603	999	1404	1620	531	531
	MW d	531	603	999	1404	1719	531	531
Western Europe	FM c,d	87.5	90.0	98.0	106.0	108.0	87.5	87.5
	MW e	531	603	999	1404	1620	531	531
	MW e	522	603	999	1404	1620	522	522
	LW a	153	160	200	260	281	153	153
	LW b	146	160	200	260	290	146	146
Japan	FM e	76.0	78.6	83.0	86.6	90.0	76.0	76.0
	MW f	522	603	999	1404	1629	522	522
Saudi Arabia	FM b	87.5	90.1	98.1	106.1	107.9	87.5	87.5
	MW g	531	603	999	1404	1602	531	531
South Africa	FM f	87.5	90.1	98.1	106.1	107.9	87.5	87.5
	MW g	531	603	999	1404	1602	531	531
Eastern Europe	FM g	64.0	74.0	84.0	94.0	104.0	64.0	64.0
	MW h	522	603	999	1404	1620	522	522

Note

FM2, FM3 and MW bands load from the low edge of these bands.

