

T-77-05-05

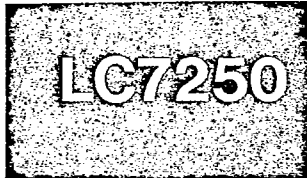

3014A

CMOS LSI

Digital Display (LED) of Frequency and Time

©523H

Applications

- Car radio applications: FM/AM receiving frequency display and clock display
- Home radio applications: FM/AM receiving frequency display and clock display
- Car clock applications: Hours-minutes, month-date/stopwatch display

Functions

- FM receiving frequency display (4 digits)
- AM receiving frequency display (4 digits)
- Hours-minutes display
- Month-date or stopwatch display (Either of these selectable)

Features

1. Single-chip C-MOS LSI for static display system
2. Capable of direct driving green LED (Drive capacity 15 mA)
3. Capable of selecting frequency display/time display
4. Uses FM/AM local oscillation signal of varactor diode, variable capacitor, or μ tuning system to digitally display FM/AM receiving frequency.
5. Covers 4 AM intermediate frequencies shown below.
+262.5, +452.5, +455, +470kHz
6. Covers 2 FM intermediate frequencies shown below.
+10.7, -10.7MHz
7. Capable of fine-adjusting AM/FM display frequency error independently
 - A variable resistor can be used to correct AM IF error within ± 2.8 kHz.
 - A variable resistor can be used to correct FM IF error within ± 140 kHz.
8. Two selections of display system (12-hour system with PM sign which is displayed during setting only, 24-hour system)
9. Programmed on long months (months having 31 days)/short months (months having 30 days). (Date in February is programmed to count up to the 29th.)
10. Easy to set time by the time signal.
11. Stopwatch capable of counting/displaying 1 second to 12 hours 59 minutes 59 seconds
12. Inhibit pin for inhibiting time setting with display unlighted
13. 4MHz crystal for reference frequency

- * For FLT display (5 digits) and frequency display only (without clock display), use the LC7253 and LC7259 (LED use), LC7258 (FLT use) respectively.

Case Outline 3014A-D42IC
(unit: mm)

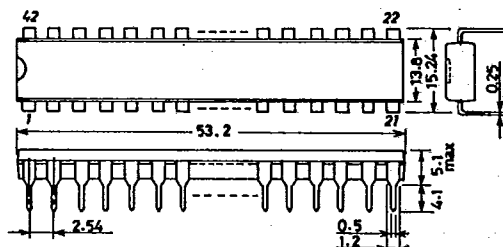

SANYO: DIP42

7058Y/T/6134KI, TS 寿 No.523-1/19

Pin Assignment

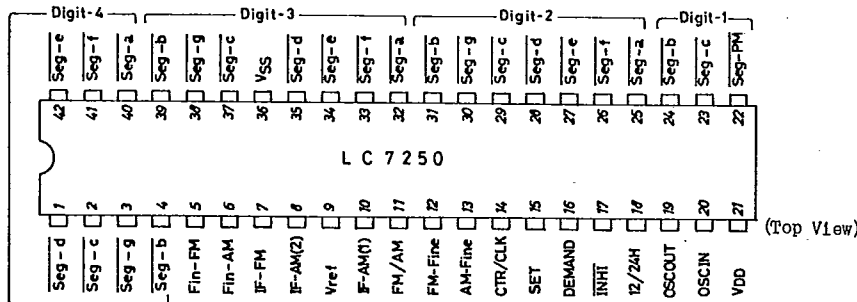

Absolute Maximum Ratings/ $T_a = 25^\circ\text{C}$, $V_{SS} = 0\text{V}$		min	typ	max	unit
Maximum Supply Voltage	V_{DD} max	-0.3		11	V
	V_{DD} max	-0.3		14	V
Reference Voltage	$V_{ref} \leq V_{DD}$	-0.3		10	V
	$V_{ref} \geq V_{DD}$, Cumulative applied time: 30 min. or less	-0.3		13	V
Input Voltage	V_I	-0.3		$V_{DD}+0.3$	V
Output Voltage	V_O	-0.3		$V_{DD}+0.3$	V
Allowable Power Dissipation	P_d max			0.8	W
Allowable Power Dissipation of Segment Output	P_d (Seg) max	Other than PM: $I_{OL} < 25\text{ mA}$		15	mW
		PM: $I_{OL} < 75\text{ mA}$		45	mW
Operating Temperature	T_{opg}	-30		+75	$^\circ\text{C}$
Storage Temperature	T_{stg}	-40		+125	$^\circ\text{C}$

Allowable Operating Conditions/ $T_a = 25^\circ\text{C}$, $V_{DD} = 8.0$ to 10.3V , $V_{SS} = 0\text{V}$, $V_{ref} = 7.9$ to $9.0\text{V} \leq V_{DD}$, $V_{ref} = 0\text{V}$ if $V_{DD} < 8.0\text{V}$		min	typ	max	unit	
Supply Voltage	V_{DD1}	All functions operating mode	8.0	9.3	10.3	V
	V_{DD2}	Only clock operating mode	4.3	5.0	8.0	V
Reference Voltage	V_{ref}	$V_{ref} \leq V_{DD}$	7.9	8.0	9.0	V
Input "H" Level Voltage	V_{IH1}	INH1, $V_{DD} = 4.3$ to 10.3V	$0.75V_{DD}$		V_{DD}	V
Input "L" Level Voltage	V_{IL1}	INH1, $V_{DD} = 4.3$ to 10.3V	V_{SS}		$0.1V_{DD}$	V
Input "H" Level Voltage	V_{IH2}	FM/AM, IF-FM, IF-AM ₁ , IF-AM ₂ , 12H/24H	$0.85V_{DD}$		V_{DD}	V
Input "L" Level Voltage	V_{IL2}	FM/AM, IF-FM, IF-AM ₁ , IF-AM ₂ , 12H/24H	V_{SS}		$0.15V_{DD}$	V
Input "H" Level Voltage	V_{IH3}	SET, DEMAND, CTR/CLK	$0.88V_{DD}$		V_{DD}	V
Input "L" Level Voltage	V_{IL3}	SET, DEMAND, CTR/CLK	V_{SS}		$0.12V_{DD}$	V
Input "M" Level Voltage	V_{IM}	SET, DEMAND, CTR/CLK	$0.36V_{DD}$		$0.64V_{DD}$	V
Input Frequency	f_{IN1}	Fin-FM, $V_{p.p} = 0.7\text{V}$, duty 50%	0.6		2.0	MHz
	f_{IN2}	Fin-AM, $V_{p.p} = 0.7\text{V}$, duty 50%	0.4		2.5	MHz
Operating Frequency	f_{opg}	Crystal is externally connected across OSC-IN and OSC-OUT.	3.5		4.2	MHz
Input Amplitude	$V_{p.p}$	Fin-FM, Fin-AM, Ceramic capacitor of $0.4\ \mu\text{F}$ is connected across V_{DD} and V_{SS} .	0.7		$V_{p.p}$	

Electrical Characteristics/ $T_a = 25^\circ\text{C}$, $V_{DD} = 8.0$ to 10.3V , $V_{SS} = 0\text{V}$, $V_{ref} = 7.9$ to 9.0V , $V_{ref} \leq V_{DD}$

			min	typ	max	unit
Input Current	I_{IN}	FM-Fine, AM-Fine, $V_{IN} = 0\text{V}$ or V_{ref}	-1		1	μA
Input "H" Level Current	I_{IH1}	IF-FM, IF-AM1, IF-AM2, CTR/CLK, 12H/24H, $V_{IN} = 0.9V_{DD}$	-80	-30	-10	μA
Input "L" Level Current	I_{IL1}	IF-FM, IF-AM1, IF-AM2, CTR/CLK, 12H/24H, $V_{IN} = 0\text{V}$	-3		0	μA
Input "H" Level Current	I_{IH2}	FM/AM, $V_{IN} = 0.9V_{DD}$	-40	-15	-5	μA
Input "L" Level Current	I_{IL2}	FM/AM, $V_{IN} = 0\text{V}$	-3		0	μA
Midpoint Setting Resistance	r_s	SET, DEMAND	40	70	100	$\text{k}\Omega$
Input Floating Voltage	V_{IF3}	SET, DEMAND, input floating	$0.45V_{DD}$		$0.55V_{DD}$	V
Input "H" Level Current	I_{IH4}	INH1, $V_{DD} = 4.3$ to 10.3V , $V_{IN} = V_{DD}$	15		400	μA
Input Floating Voltage	V_{IF4}	INH1, $V_{DD} = 4.3$ to 10.3V , input floating	0		0.3	V
Feedback Resistance	R_{f1}	Feedback resistance across OSC-IN and OSC-OUT		3		$\text{M}\Omega$
	R_{f2}	Feedback resistance of Fin-FM		3		$\text{M}\Omega$
	R_{f3}	Feedback resistance of Fin-AM		3		$\text{M}\Omega$
Output "L" Level Voltage	V_{OL1}	PM, $V_{DD} = 8.0\text{V}$, $I_{OL} = 45\text{mA}$			0.7	V
Output "L" Level Voltage	V_{OL2}	Segment outputs other than PM, $V_{DD} = 8.0\text{V}$, $I_{OL} = 15\text{mA}$			0.7	V
Output Leak Current	I_{OFF}	All segment outputs, $V_{DD} = 10.3\text{V}$ $V_{OH} = 10.3\text{V}$			10	μA
Current Dissipation	I_{DD1}	$V_{DD} = 10.3\text{V}$, $f_{opg} = 4\text{MHz}$ (with crystal mounted), $f_{IN2} = 2.5\text{MHz}$ (0.7V_{p-p})		8	17	mA
	I_{DD2}	$V_{DD} = 5.5\text{V}$, $f_{opg} = 4\text{MHz}$ (with crystal mounted), $V_{ref} = 0\text{V}$, INH1 = 0V		1	2.5	mA
	I_{ref}	$V_{DD} = 10.3\text{V}$, $V_{ref} = 9\text{V}$, AM-Fine = FM-Fine = V_{ref}		0.5	1.5	mA

(Note) + sign: Flowing into LSI
 - sign: Flowing out of LSI

Equivalent Circuit Block Diagram

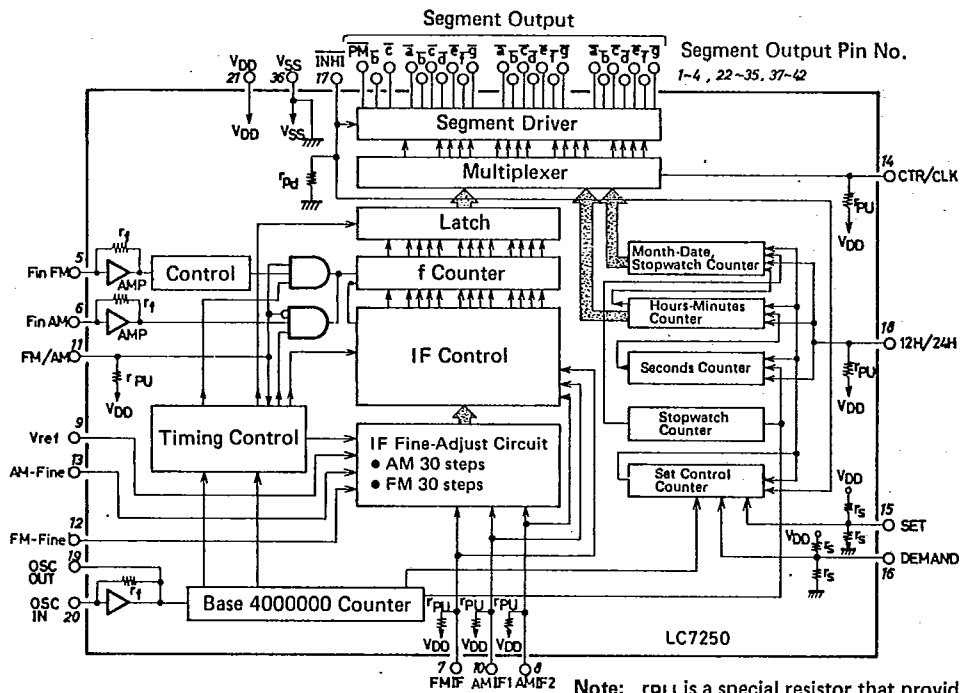

Note: r_{PU} is a special resistor that provides the specification value at "H" level and a high value at "L" level.

1. Display

1-1 Configuration and display font

3-1/2-digit, 7-segment LED's are used to display time and frequency in the display font shown below.

Font 1 2 3 4 5 6 7 8 9 0

1-2 Display system

- Static display

1-3 Display range

- Frequency (AM): 000kHz to 1999kHz (The highest-order digit "0" is blanked out.)
- Frequency (FM): 00.0MHz to 199.9MHz (The highest-order digit "0" is blanked out.)
- Clock (12-hour display system): 1:00 to PM12:59 (The highest-order digit "0" is blanked out.)
- Clock (24-hour display system): 0:00 to 23:59 (The highest-order digit "0" is blanked out.)
- Stopwatch (minutes-seconds): 0 minute 00 second to 9 minutes 59 seconds (The highest-order digit is blanked out.)
- Stopwatch (hours-minutes): 0 hour 00 minute to 12 hours 59 minutes (The highest-order digit "0" is blanked out.)

2. Input/Output Signal**2-1 Switch signal**

- Logic "H": V_{DD}
- Logic "M": $1/2V_{DD}$ (Intermediate level between V_{DD} and V_{SS})
- Logic "L": V_{SS}

2-2 FM/AM frequency input

- Amplitude: 0.7V or greater
- Frequency: FM: 2.0MHz or less (FM local oscillation frequency is 1/100-divided and input.)
AM: 2.5MHz or less

2-3 Reference frequency: Crystal of 4.000000MHz**2-4 Segment output: N channel open drain****3. Functional Description (Refer to Sample Application Circuit on page 270.)****3-1 Selection of month-date/stopwatch**

Since the month-date counter is also used as the stopwatch counter inside the LSI, either month-date function or stopwatch function can be selected. For the description given below, refer to Sample Application Circuit. In Sample Application Circuit, providing only the CLK switch makes a clock with the month-date function; providing only the STW switch makes a clock with the stopwatch function. (If both switches are coupled, both functions are available.)

3-2 Selection of frequency display/clock display. () is for using stopwatch function.

The CLK switch (or STW switch) is used to select the frequency display/clock display.

- Frequency display: Turn OFF the CLK switch (and STW switch).
- Clock display: Turn ON the CLK switch (or STW switch).

3-3 Operation for frequency display**(1) Selection of FM/AM display**

- AM display: Turn ON the FM/AM switch.
- FM display: Turn OFF the FM/AM switch.

(2) Selection of IF

- FM IF +10.7MHz: Set the FM-IF pin to V_{DD} .
- FM IF -10.7MHz: Set the FM-IF pin to V_{SS} .
- AM IF +262.5kHz: Set the AM-IF (1) pin to V_{DD} and AM-IF (2) pin to V_{DD} .
- AM IF +452.5kHz: Set the AM-IF (1) pin to V_{SS} and AM-IF (2) pin to V_{DD} .
- AM IF +455.0kHz: Set the AM-IF (1) pin to V_{SS} and AM-IF (2) pin to V_{SS} .
- AM IF +470.0kHz: Set the AM-IF (1) pin to V_{DD} and AM-IF (2) pin to V_{SS} .

(3) Fine adjustment of frequency display**a. To correct an FM frequency display, follow the procedure shown below.**

- (i) Set the display mode to the FM display.
- (ii) Input the reference FM frequency to the Fin-FM.
- (iii) Change the applied voltage at the FM/AM pin from V_{DD} to $1/2V_{DD}$.
- (iv) Adjust the FM-VR so that the display coincides with the reference FM frequency. The point at which flashing stops is the optimum.
- (v) Change the applied voltage at the FM/AM pin from $1/2V_{DD}$ to V_{DD} .
- (vi) This completes adjustment.

Example: Correcting the display to 80.0MHz. IF = -10.7MHz

- (i) Set the FM/AM pin to V_{DD} .
- (ii) Receive 80.0MHz and input the 1/100-divided local oscillation frequency to the Fin-FM pin.
- (iii) Change the applied voltage at the FM/AM pin from V_{DD} to $1/2V_{DD}$.
- (iv) Adjust the FM-VR so that the display coincides with 80.0MHz. The point at which flashing stops is the optimum.
- (v) Change the applied voltage at the FM/AM pin from $1/2V_{DD}$ to V_{DD} .
- (vi) This completes adjustment.

- b. To correct an AM frequency display, follow the procedure shown below.
- (i) Set the display mode to the AM display.
 - (ii) Input the reference AM frequency to the Fin-AM.
 - (iii) Change the applied voltage at the FM/AM pin from V_{SS} to $1/2V_{DD}$.
 - (iv) Adjust the AM-VR so that the display coincides with the reference AM frequency. The point at which flashing stops is the optimum.
 - (v) Change the applied voltage at the FM/AM pin from $1/2V_{DD}$ to V_{SS} .
 - (vi) This completes adjustment.

Example: Correcting the display to 950kHz. $IF = 455kHz$

- (i) Set the FM/AM pin to V_{SS} .
- (ii) Receive 950kHz and input the local oscillation frequency to the Fin-AM pin.
- (iii) Change the applied voltage at the FM/AM pin from V_{SS} to $1/2V_{DD}$.
- (iv) Adjust the AM-VR so that the display coincides with 950kHz. The point at which flashing stops is the optimum.
- (v) Change the applied voltage at the FM/AM pin from $1/2V_{DD}$ to V_{SS} .
- (vi) This completes adjustment.

3-4. Operations related to clock

- Push the CLK switch (or STW switch).
- (1) Hours-minutes display mode
 - The hours-minutes display mode is entered with the hours-minutes setting switch and month-date/STW switch released.
 - (2) Hours-minutes setting mode and mode of setting by the time signal
 - Push the hours-minutes setting switch, and the hours-minutes setting mode is entered and the display flashes at a 2Hz rate.
 - Setting of hours is executed at a 2Hz rate 1.2 seconds after pushing the UPPER switch. No carry from hours to date occurs. When setting of hours is completed, the display stops flashing.
 - Setting of minutes is executed at a 2Hz rate 1.2 seconds after pushing the LOWER switch. No carry from minutes to hours occurs. When setting of minutes is completed, the display stops flashing.
 - Setting by the time signal is executed by pushing/releasing the LOWER switch within 1 second when the display is flashing. Setting by the time signal means that the moment minutes and seconds are cleared to 0 minute and 0 second respectively hours are incremented by 1 when the minutes display is at 30 to 59. Setting by the time signal can be executed only when the hours-minutes display is flashing.
 - (3) Month-date display and month-date setting mode/long month (31 days, short month (30 days) programmed (counting date in February up to the 29th). Provide the CLK switch. With the CLK switch pushed, the month-date display mode is entered and setting of month-date is executed as follows:
 - Push the month-date/STW switch and release the hours setting switch, and the month-date display mode is entered.
 - Setting of month is executed at a 2Hz rate 1.2 seconds after pushing the UPPER switch.
 - Setting of date is executed at a 2Hz rate 1.2 seconds after pushing the LOWER switch. No carry from date to month occurs.
 - (4) Stopwatch mode

Provide the STW switch. With the STW switch pushed, the stopwatch operation is performed as follows:

 - Push the month-date/STW switch. Release the hours setting switch.
 - Push/release the UPPER switch, and the stopwatch starts counting. Push/release the UPPER switch again, and the stopwatch stops counting.
 - Selecting the hours-minutes display mode/minutes-seconds display mode of stopwatch and clearing the counter. Push/release the LOWER switch within 1 second, and the hours-minutes display mode is entered. Push/release the LOWER switch again within 1 second, and the minutes-seconds display mode is entered. When in the minutes-seconds display mode, the PM sign flashes at a 1Hz rate.
 - Hold the LOWER switch pushed for 1.2 seconds or more, and the display becomes 0:00 and the counter is cleared. When cleared, the minutes-seconds display mode is entered and the PM sign flashes. (The PM pin is turned ON/OFF.)

4. Selection of function

Selection of each function described above is summarized as follows:

- Functions related to frequency and clock

Function	Display Mode	CLK SW	STW SW	FM/AM SW
Frequency Operation	FM display	off	off	off
	AM display	off	off	on
Clock Operation	Hours-minutes or month-date display	on	⊙	⊙
	Hours-minutes or stop-watch display	off	on	⊙

⊙ : Either on or off

- Functions related to hours-minutes (Provide the CLK or STW SW.)

	Hours-minutes setting SW	Month-date/STW SW	UPPER SW	LOWER SW
Hours-Minutes Display	off	off	⊙	⊙
Execution of Hours Setting	on	⊙	on	off
Execution of Minutes Setting	on	⊙	off	on
Execution of Setting by the Time Signal	on	⊙	off	on < 1 second

⊙ : Either on or off

- Functions related to month-date (Provide the CLK SW.)

	Hours-minutes setting SW	Month-date/STW SW	UPPER SW	LOWER SW
Month-Date Display	off	on	off	off
Execution of Month Setting	off	on	on	off
Execution of Date Setting	off	on	off	on

- Functions related to stopwatch (Provide the STW SW.)

Function	UPPER SW	LOWER SW
Stopwatch Counter, Reset	off	on > 1.2 sec.
Minutes-Seconds Display → Hours-Minutes Display or Hours-Minutes Display → Minutes-Seconds Display	off	on < 1 sec.
Start → Stop or Stop → Start	on	off

5. Pin Description

5-1 CTR/CLK (counter/clock) input

- Input pin for selecting frequency display, clock, stopwatch
- "L" level: Hours-minutes and month-date display
- "M" level: Hours-minutes and stopwatch display
- "H" level: Frequency counter display

5-2 FM/AM (FM/AM select) input

- Input pin for setting the frequency counter and frequency control to FM or AM use
- "L" level: AM display
- "H" level: FM display

5-3 FM-IF (FM IF setting) input

- Input pin for specifying FM IF
- IF: -10.7MHz, +10.7MHz
- "L" level: -10.7MHz
- "H" level: +10.7MHz

5-4 AM-IF (1), AM-IF (2) (AM IF setting) input

- IF: 262.5kHz, 452.5kHz, 470kHz, 455kHz

AM-IF (1)	AM-IF (2)	IF
[L]	[L]	+455.0 kHz
[H]	[L]	+470.0 kHz
[L]	[H]	+452.5 kHz
[H]	[H]	+262.5 kHz

5-5 FM-Fine (IF fine adjust) input

- Input pin for fine-correcting FM IF error
- Pin for inputting the voltage divided by a variable resistor connected across V_{ref} and V_{SS}

5-6 AM-Fine (IF fine adjust) input

- Input pin for fine-correcting AM IF error
- Pin for inputting the voltage divided by a variable resistor connected across V_{ref} and V_{SS}
- Fine adjust range of FM-Fine, AM-Fine
 FM-Fine: 28-step adjustable in 10kHz/step between 10.60MHz to 10.80MHz (± 140 kHz)
 AM-Fine: 28-step adjustable in 0.2kHz/step with IF as the center (± 2.8 kHz)

5-7 Fin-FM (frequency) input

- Input pin for applying FM local OSC frequency (1/100 prescaler is connected externally.)
- Pin for inputting frequency of input voltage of 0.7V_{p-p} or greater
- Maximum frequency: 2MHz (duty 50%)
- 1/100 prescaler is connected externally.

5-8 Fin-AM (frequency) input

- Input pin for applying MW local OSC frequency
- Pin for inputting frequency of input voltage of 0.7Vp.p or greater
- Maximum frequency: 2.5MHz (duty 50%)

5-9 OSC IN, OSC OUT (crystal oscillation)

- Input/output pin for crystal oscillation
- Input/output pin for connecting a crystal (4.000000MHz)

5-10 DEMAND (time read) input

- Input pin for selecting hours-minutes read/setting, month-date read/setting, stopwatch mode

CTR/CLK	DEMAND	Mode
┌M┐or┌L┐	┌H┐	Mode of setting by the time signal and hours-minutes setting mode
┌M┐or┌L┐	┌M┐	Time display mode
┌L┐	┌L┐	Month-date display mode and month-date setting mode
┌M┐	┌L┐	Stopwatch mode

[Note] ◆ The following shows how to change the month-date setting mode to the stopwatch mode or vice versa.

- Changing the month-date setting mode to the stopwatch mode
CTR/CLK = "M", DEMAND = "L", SET = "L" (1.2 seconds or more)
- Changing the stopwatch mode to the month-date setting mode
CTR/CLK = "L", DEMAND = "L", SET = "L" or "H" (1.2 seconds or more)
- ◆ When in the mode of setting by the time signal, all digits displayed flash (2Hz).

5-11 SET (time setting) input

- Input pin for setting hours, minutes, month, date and starting/stopping/clearing stopwatch (corresponding type)

This input pin is set at "M" level normally. The input signal of "H"/"L" level acts in 6 ways as shown below.

- When in the mode of setting by the time signal and hours-minutes setting mode (CTR/CLK = "L" or "M")
 - "H" level: Execution of hours setting
Advances at a 2Hz rate 1.2 seconds after the pin is set to "H" level.
 - "L" level: Execution of setting by the time signal and minutes setting
Advances at a 2Hz rate 1.2 seconds after the pin is set to "L" level.
Setting by the time signal is executed when the pin is set to "M" level within 1.0 second after set to "L" level.

[Note] ◆ No carry to high-order digit occurs.

- When in the month-date setting mode (CTR/CLK = "L")
 - "H" level: Execution of month setting
Advances at a 2Hz rate 1.2 seconds after the pin is set to "H" level.
 - "L" level: Execution of date setting
Advances at a 2Hz rate 1.2 seconds after the pin is set to "L" level. No carry to the month digit occurs.
- When in the stopwatch mode (CTR/CLK = "M")
 - "L" level: Minutes-seconds display, hours-minutes display and clear
The counter is cleared 1.2 seconds after the pin is set to "L" level. (Display 0:00 second)
The minutes-seconds display mode/hours-minutes display mode are alternated when the pin is set to "M" level within 1.0 second after set to "L" level. The PM output pin turned ON/OFF at a 1Hz rate to indicate the minutes-seconds display mode.
 - "H" level: Start and stop
Start/stop are alternated by setting the pin to "L"/"M" level alternately. When cleared, the counter stops and the minutes-seconds display mode is entered and the PM pin is turned ON/OFF at a 1Hz rate.

5-12 $\overline{\text{INH}}$ (inhibit) input pin

Input pin for turning OFF the segment pins, inhibiting the SET/DEMAND pin from functioning, and preventing the Fin-AM/Fin-FM amp from operating. In car applications, this pin is useful to minimize current dissipation when the engine is stopped.

"H" level: Normal operation

"L" level: Segment pin OFF, SET/DEMAND pin function inhibit

The reason why the SET/DEMAND pin is inhibited from functioning when at "L" level is to prevent time from being set mistakenly when the display is blanked out; and the reason why the amp is stopped from operating is to minimize current dissipated in the amp.

5-13 12H/24H (hour display system select) input pin

Input pin for selecting 12-hour system with PM sign/24-hour system

"H" level: 12-hour system with PM sign

"L" level: 24-hour system

Make connection as shown right.

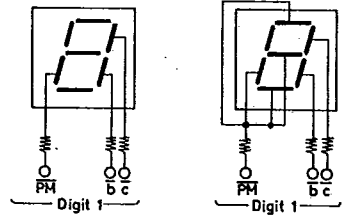

12-hour system

24-hour system

6. Timing Chart

6-1 Timing chart for time setting (CRT/CLK = "L" or "H")

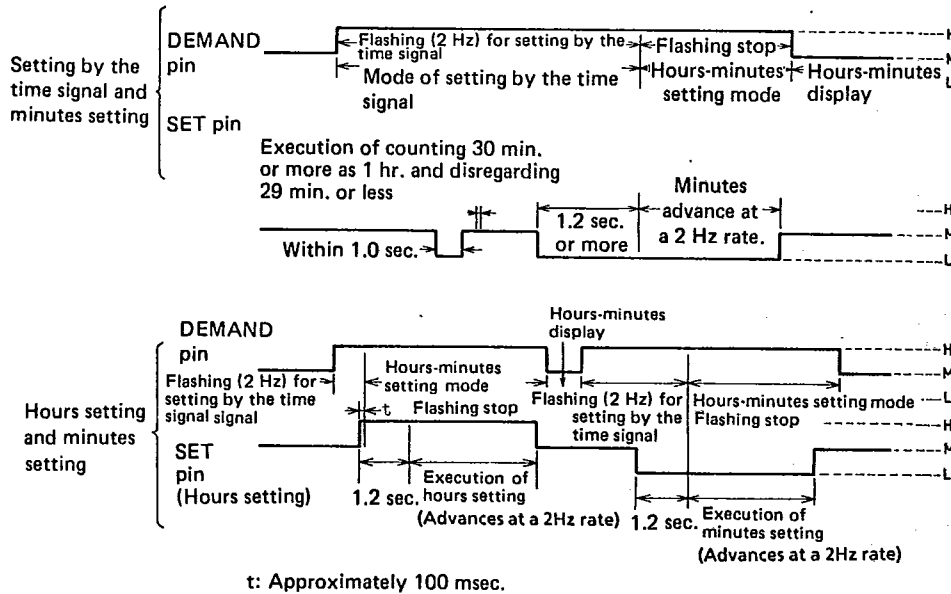

6-2 Timing chart for month-date setting

- It is unknown whether the month-date mode or stopwatch mode is entered at the time of application of power. Therefore, the month-date mode must be entered as follows:

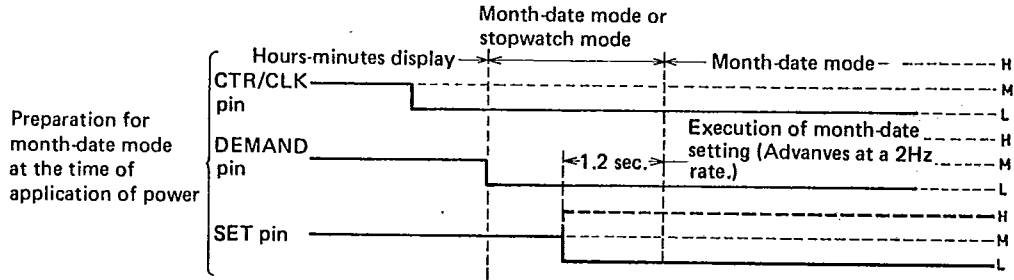

- Month-date setting

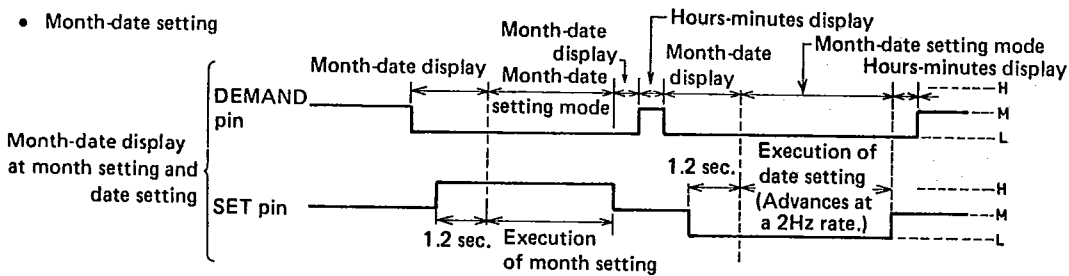

6-3 Timing chart for stopwatch mode

- It is unknown whether the month-date mode or stopwatch mode is entered at the time of application of power. Therefore, the stopwatch mode must be entered as follows:

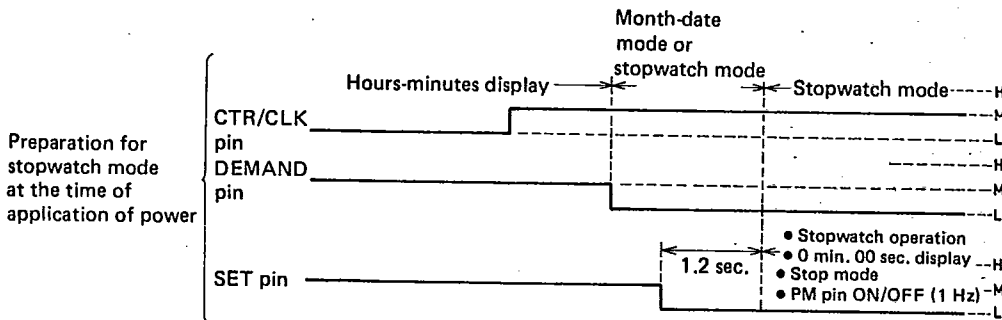

- Timing chart for stopwatch operation

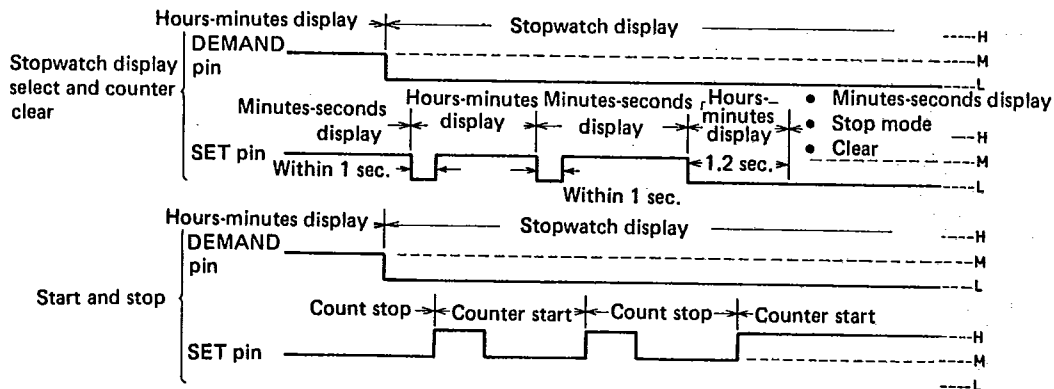

7. Sample Display at Each Mode

1. FM display: Display at 106MHz reception

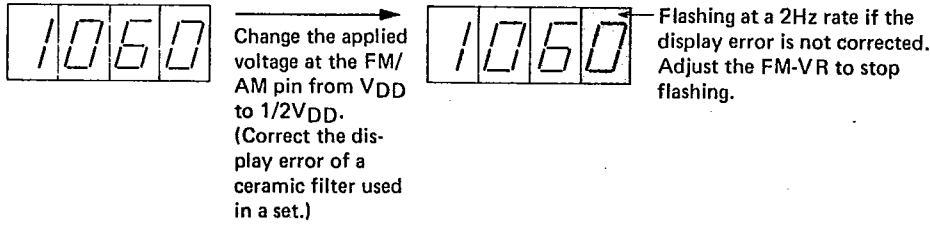

2. AM display: Display at 950kHz reception

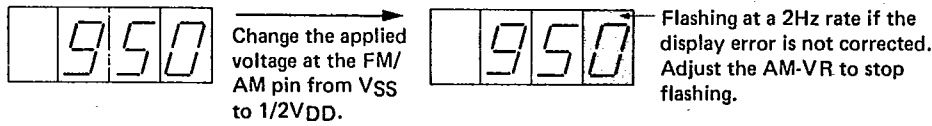

3. Setting by the time signal: Setting to PM12:00 by the time signal

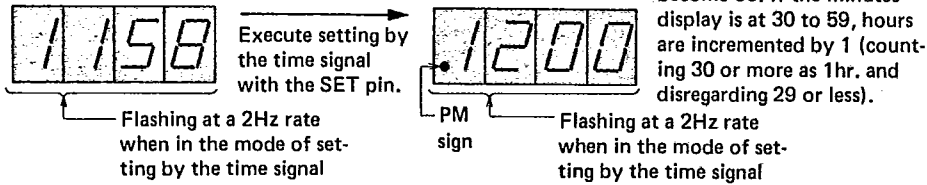

4. Hours-minutes display: Display of PM12:34

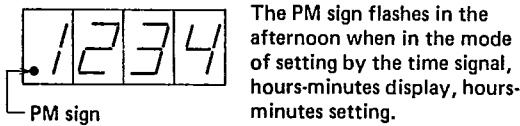

5. Hours-minutes setting: Setting to 11:45 from PM11:23

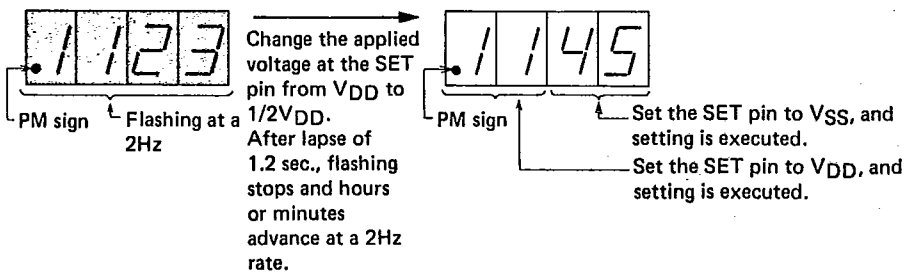

6. Month-date display and setting: Setting to December 9 from September 9

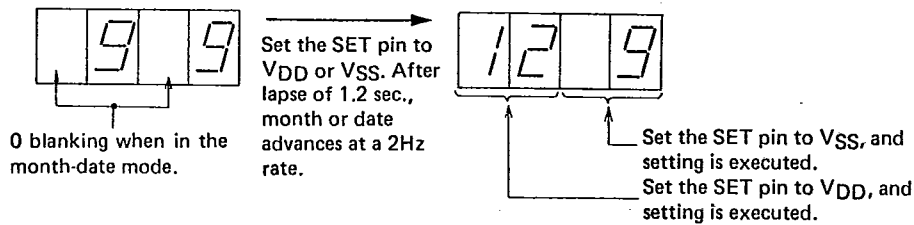

7. Stopwatch display

- 7 hours 00 minute 00 second

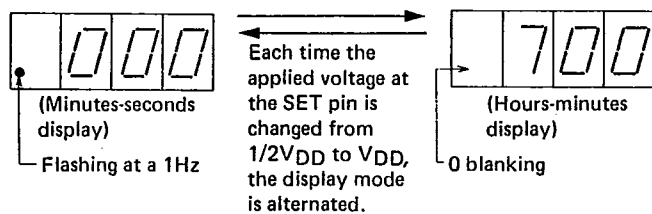

- 12 hours 59 minutes 43 seconds

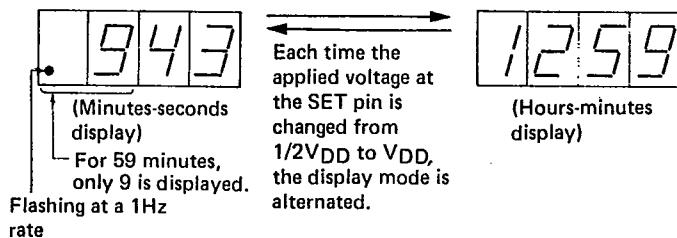

LC7250

T-77-05-05

Surge voltage eliminator
Reference: LED display tube (For details, see each separate catalog.)
SL1495 (12hr. system)
SL2475 (12hr./24hr. system)
In addition to these, the SL1427, SL2427, SL1447, SL2447, SL1711 are available.

8. Sample Application Circuit using the LC7250

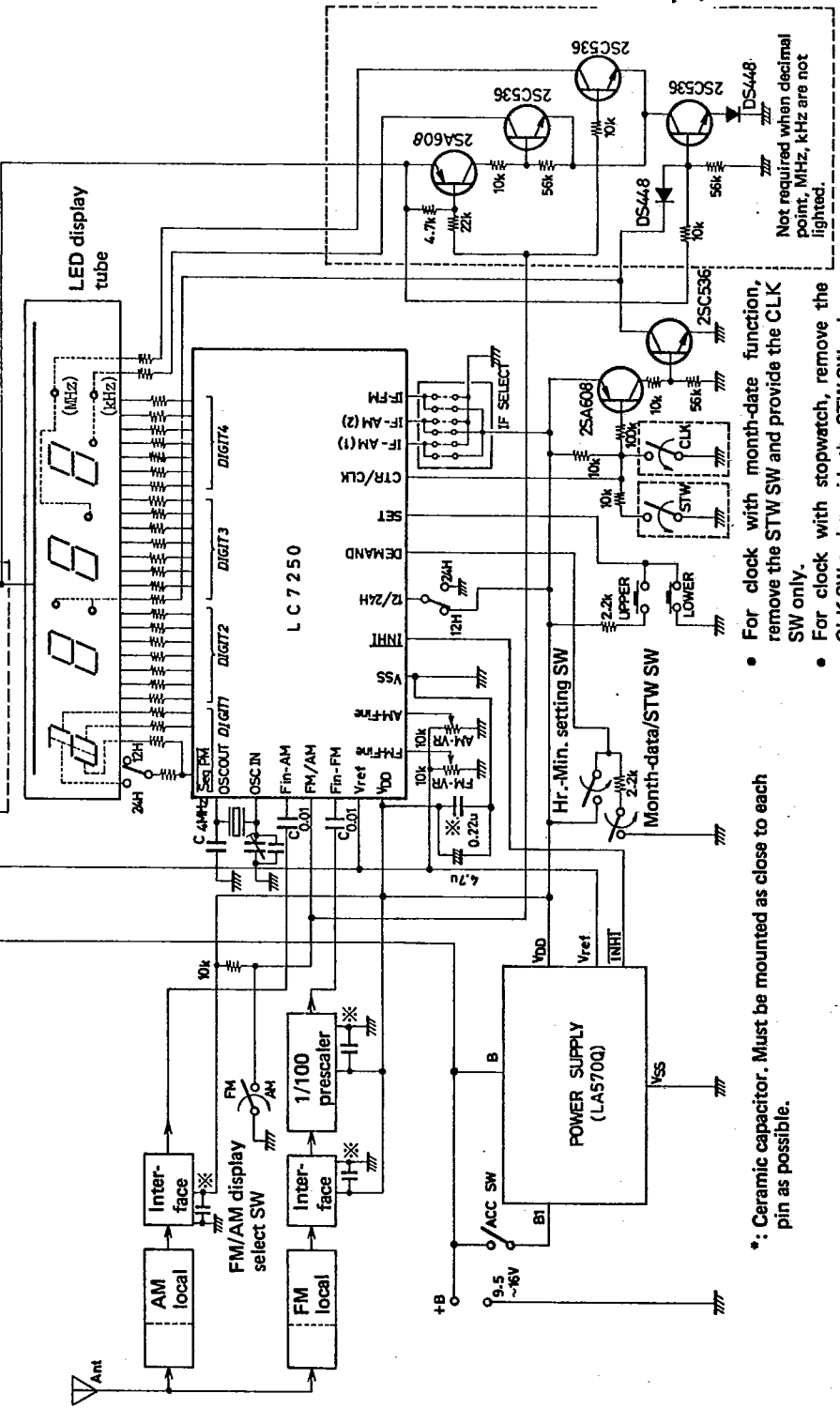

Not required when decimal point, MHz, kHz are not lighted.

- For clock with month-date function, remove the STW SW and provide the CLK SW only.
- For clock with stopwatch, remove the CLK SW and provide the STW SW only.

*: Ceramic capacitor. Must be mounted as close to each pin as possible.

9. Proper Cares in Using IC

1. Accuracy of oscillation frequency in clock application and only frequency display application

Clock operation: An error of 1 ppm is equivalent to a monthly error of approximately 2.6 seconds. Therefore, an error within ± 10 ppm must be attained to yield a monthly error within ± 30 seconds. An error within ± 10 ppm is attained by adjusting the oscillation frequency to within $4.0 \times 10^6 \pm 40$ Hz.

Frequency display only: The count error shown below is attained by adjusting the oscillation frequency to within $4.0 \times 10^6 \text{Hz} \pm 100 \text{ppM}$ ($4.0 \times 10^6 \pm 400$ Hz).
 AM: ± 100 Hz
 FM: ± 10 kHz

2. How to adjust the oscillation frequency

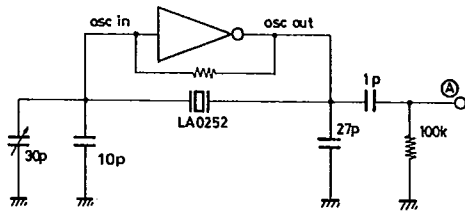

- For 10pF, 27pF, it is recommended to use capacitors having a temperature characteristic of 0 ppm.
- 27pF is a value including a stray capacitance of the board.
- Connect a probe (10pF or less, 5Mohms or more) to (A) and count with a frequency counter.
- Number of digits of counter
 Clock operation 6 digits or more
 Frequency display only 5 digits or more
- Refer to the OSC characteristic mentioned later.

3. How to improve the S/N

The main noise source is the 4MHz oscillator and prescaler. Of course, these noise sources must be separated from the receiving system as far as possible and further it is recommended to take the necessary measures shown below around the LC7250.

- (1) Connect a capacitor of 0.22 μ F (ceramic) or 2.2 μ F (electrolytic) as close to the VDD pin and VSS pin of the LC7250 as possible.
- (2) Separate VDD of the LC7250 from the power line of LED.
 Make the VSS line of the LC7250 thick and short and separate it from other GND line.
- (3) Limit the amplitude of FM prescaler output to 0.7 to 1.0V.

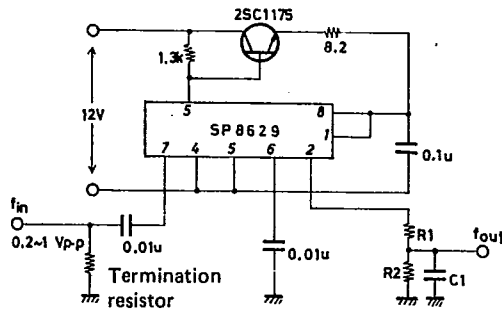

How to fix R1, R2, C1 constants

Fix the ratio of R1 to R2 and the constant of C1 so that the following waveform of f_{out} is obtained at $R1 + R2 = 5$ to 10kohms, $f_{in} = 120$ MHz (FM upper limit frequency).

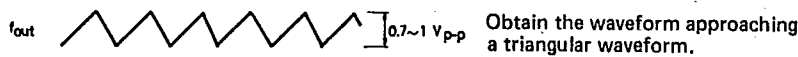

LC7250

T-77-05-05

(4) If it is necessary to make S/N 60 to 70 dB or more, it is desirable to shield the LC7250 and peripheral circuit including the prescaler.

4. How to correct the error of a frequency displayed
 With a frequency displayed, follow the procedure shown below. R2 and T SW are provided for this correction.

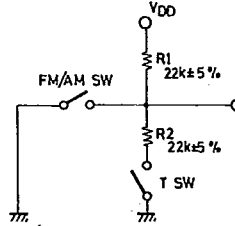

(1) How to fine-correct FM frequency displayed

- (1) Set to the FM display mode.
- (2) For example, receive 80.00 MHz and input 1/100-divided FM local OSC frequency to the Fin pin.
- (3) Set the FM/AM pin to 1/2V_{DD}.
- (4) Adjust FM adjusting variable resistor (FM-VR) so that the display becomes 80.0 and flashing on the 4th digit stops.
- (5) Set the FM/AM pin to V_{DD}.
- (6) This completes adjustment.

	FM/AM SW	T SW
(1)	off	off
(2)	off	off
(3)	off	on
(4)	off	on
(5)	off	off
(6)		

(2) How to fine-correct AM frequency

- (1) Set to the AM display mode.
- (2) For example, receive 950 kHz and input AM local OSC frequency to the Fin pin.
- (3) Set the FM/AM pin to 1/2V_{DD}.
- (4) Adjust AM adjusting variable resistor (AM-VR) so that the display becomes 950 and flashing on the 4th digit stops.
- (5) Set the FM/AM pin to V_{SS}.
- (6) This completes adjustment.

	AM/AM SW	T SW
(1)	on	off
(2)	on	off
(3)	on	on (Must go through this state.)
(4)	off	on
(5)	on	off
(6)		

(3) Operation during fine-connection

The counter for frequency display has 4.5 digits and gives 3.5-digit display with the 5th digit discarded. With the FM/AM pin set to 1/2V_{DD}, flashing stops when the 5th digit is 4 or 5; flashing at a 2 Hz occurs when the 5th digit is other than 4 or 5.
 In (1) above, 80.0 display is given at 80.00 MHz±40 kHz of receiving frequency. In (2) above, 950 display is given at 950 kHz±40 kHz of receiving frequency.

LC7250

T-77-05-05

[Reference Data/OSC Characteristic]

Note for designing

- (1) $C1 = C2 = 43 \text{ pF}$ or 68 pF is recommended considering the reduced voltage characteristic ($\Delta F/F$).
- (2) It is desirable to make ($V_{START} R_S$) $C1$ and $C2$ smaller considering the stability in oscillation.
- (3) $C1 = C2 = 27 \text{ pF}$ is recommended considering the balance between (1) and (2) above. This value include a stray capacitance of the board. In actual applications, it is recommended to use a ceramic capacitor of 10 pF , a trimmer capacitor of 30 pF for $C1$ and a ceramic capacitor of 27 pF for $C2$.
- (4) Oscillation frequency (f_{OSC}) of the LA0252 must be fixed so that $\Delta F/4 \text{ MHz} = 0 \text{ ppm}$ is yielded at $C1 = C2 = 27 \text{ pF}$ (typ). Since V_{DD} , R_S , etc. are also the factors that change f_{OSC} , information on V_{DD} , R_S , etc. should be given to the crystal manufacturer.
- (5) 1 ppm equivalent to a monthly error of approximately 2.6 seconds

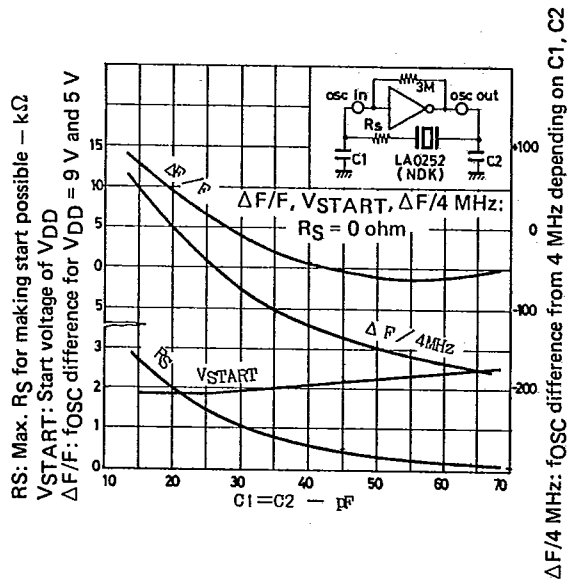

10. Various Characteristics (See below.)

LC7250

T-77-05-05

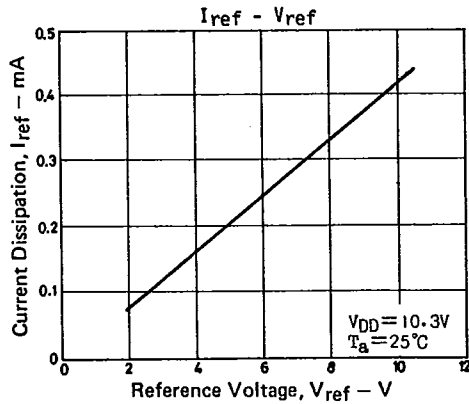
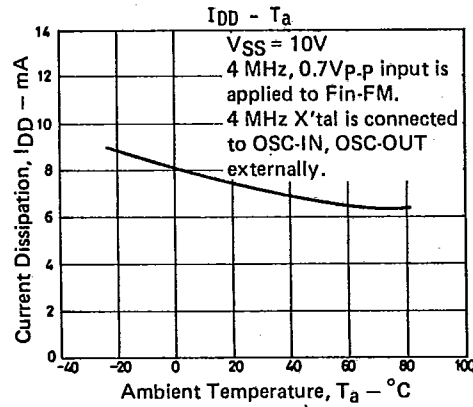
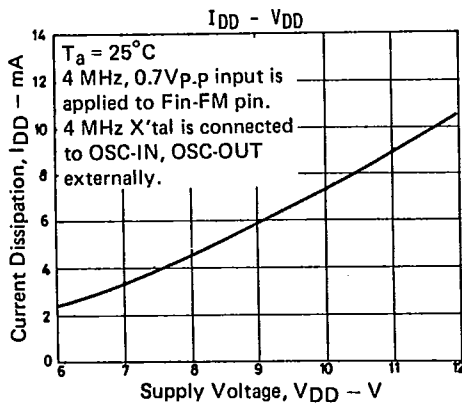
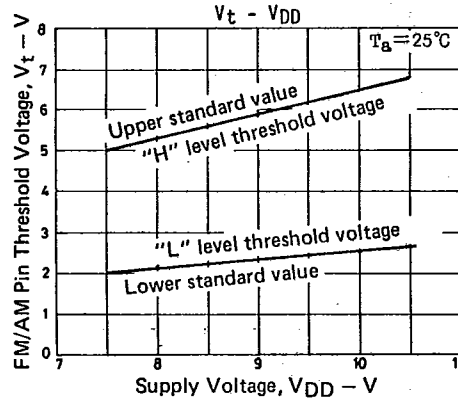
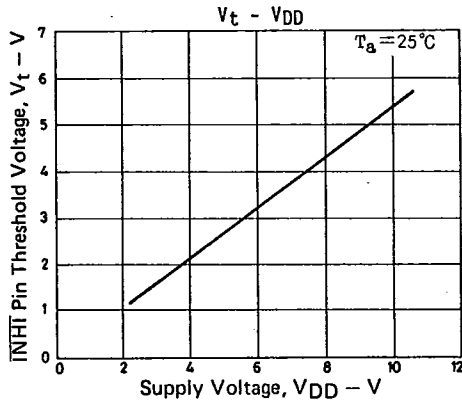
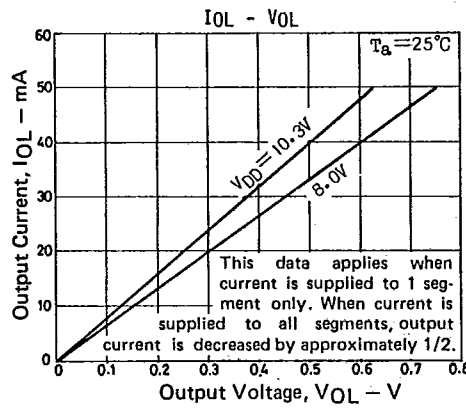
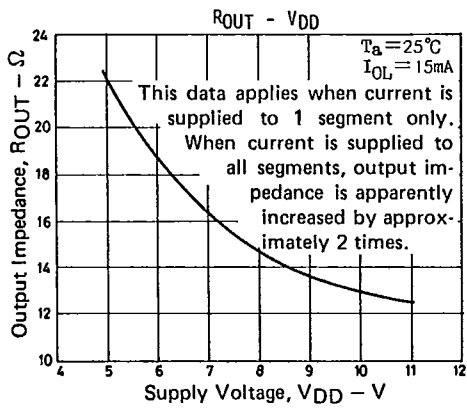

LC7250

T-77-05-05

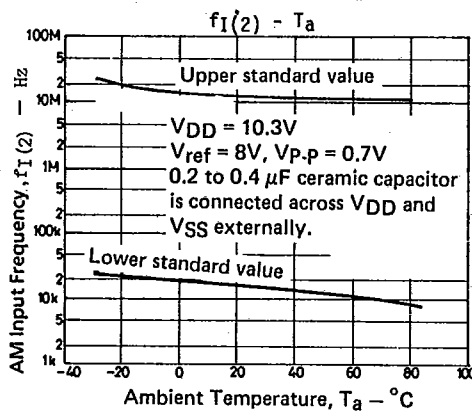
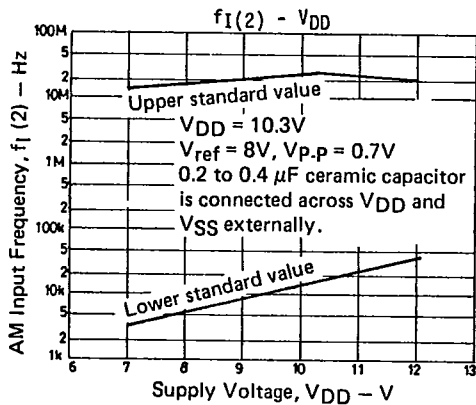
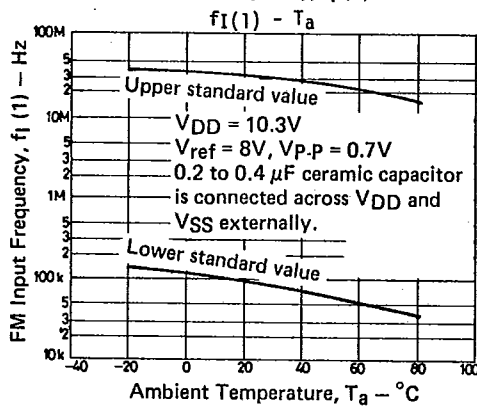
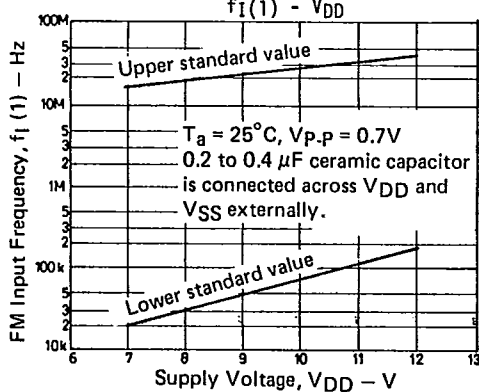
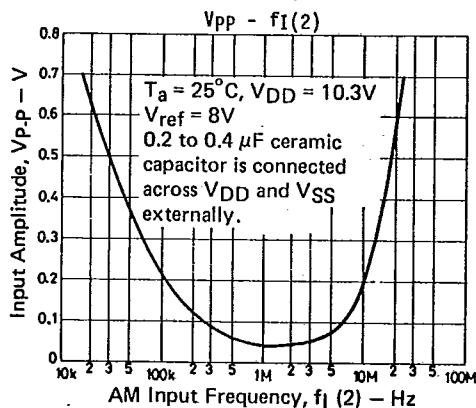
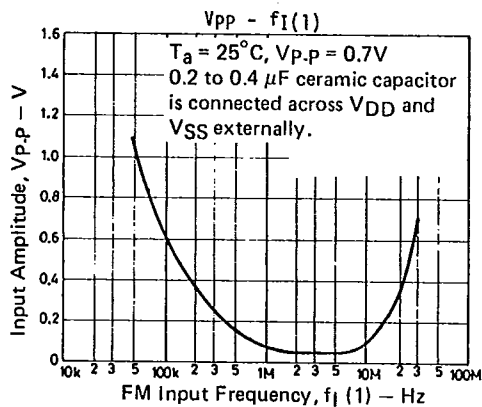

T-90-20

AUDIO-USE MOS IC CASE OUTLINES

- All of Sanyo audio-use MOS IC case outlines are illustrated below.
- All dimensions are in mm, and dimensions which are not followed by min. or max. are represented by typical values.
- No marking is indicated.

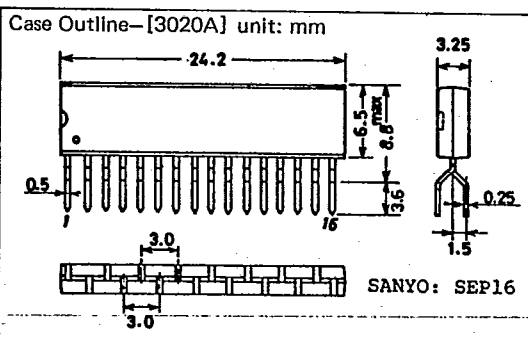
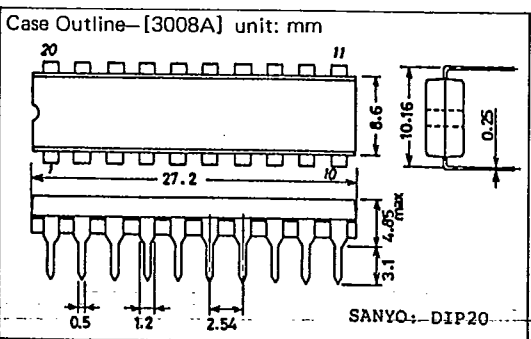
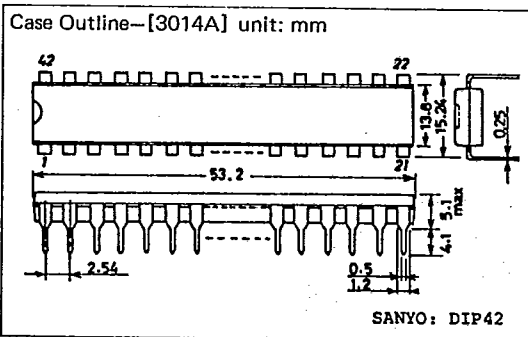
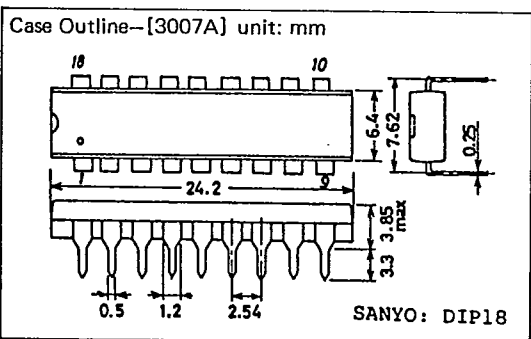
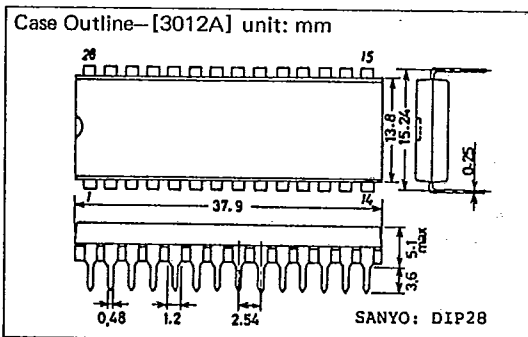
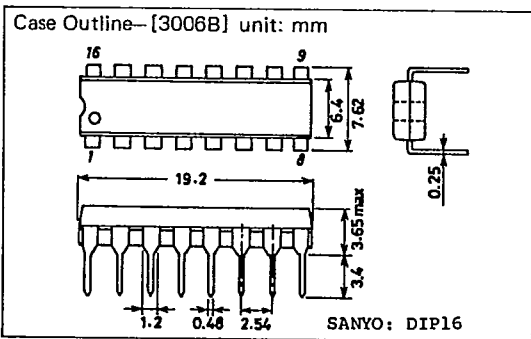
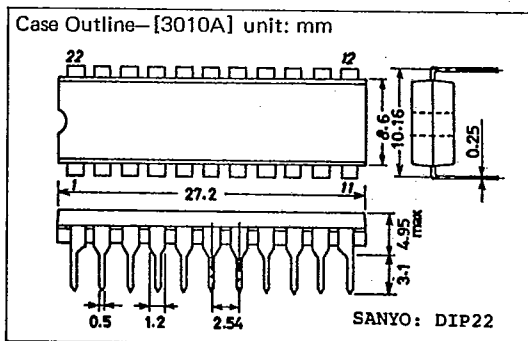
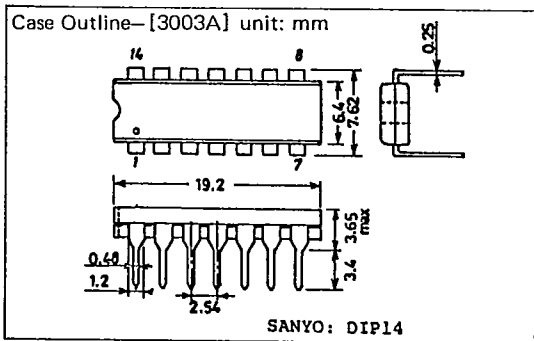

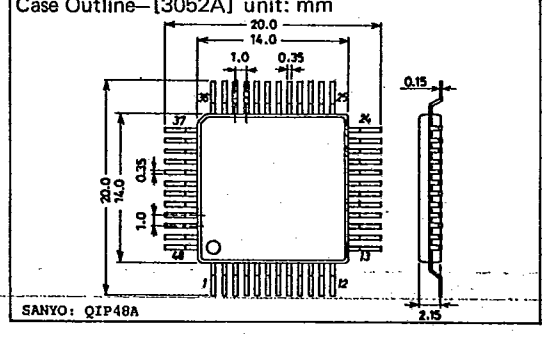
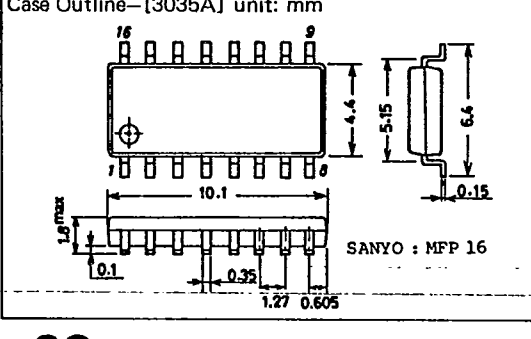
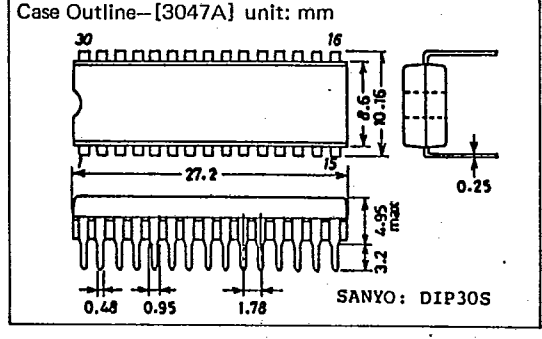
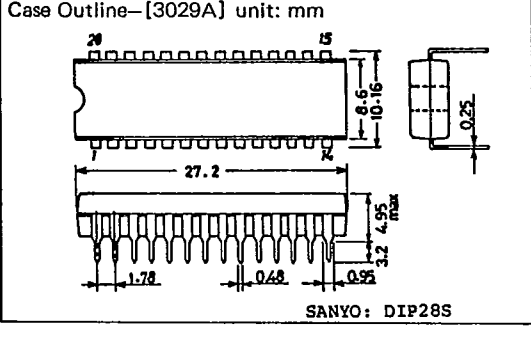
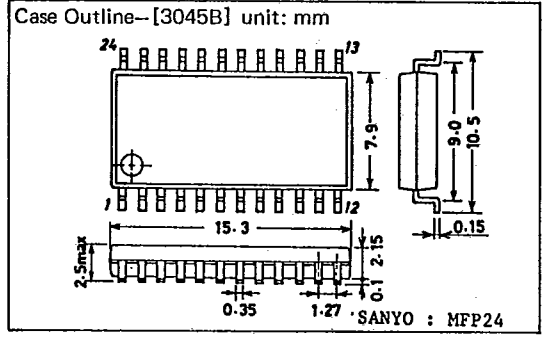
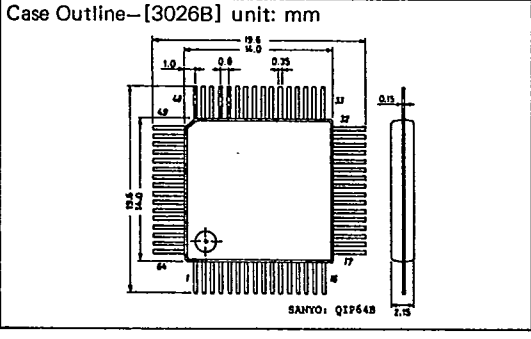
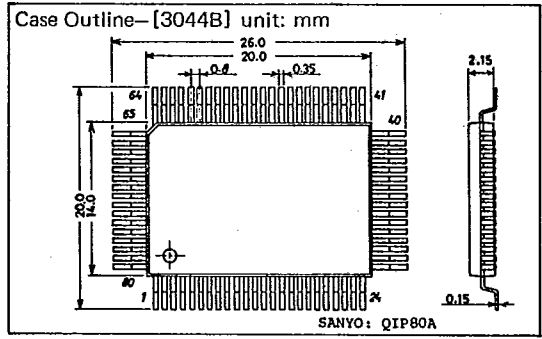
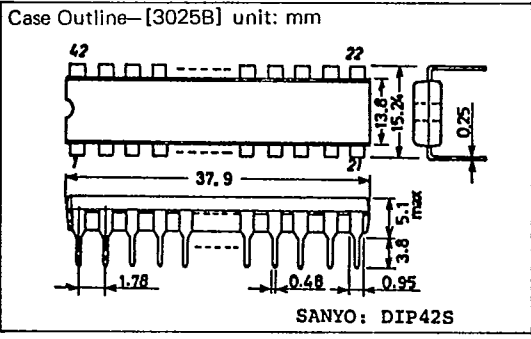
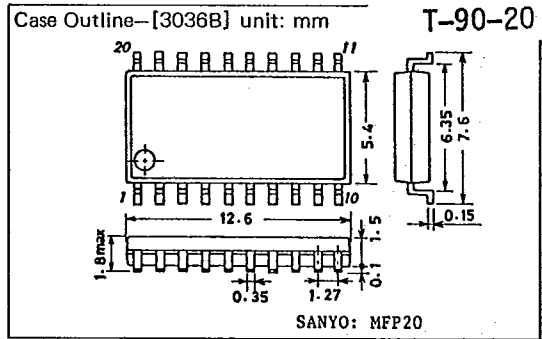
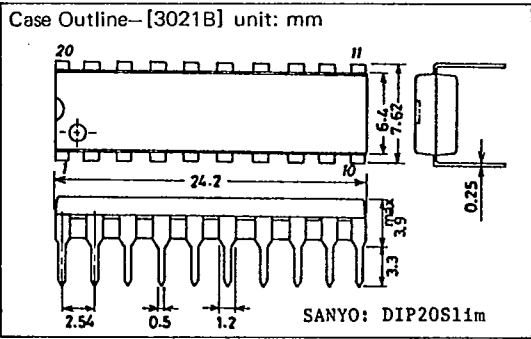

Case Outline—[3057] unit: mm

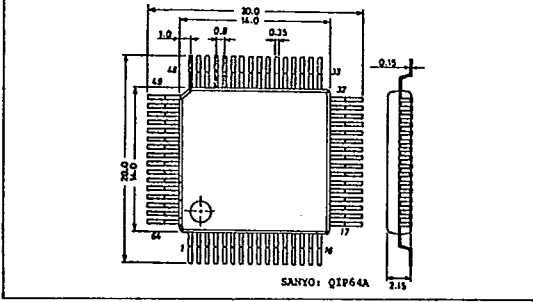

Case Outline—[3084] unit: mm

T-90-20

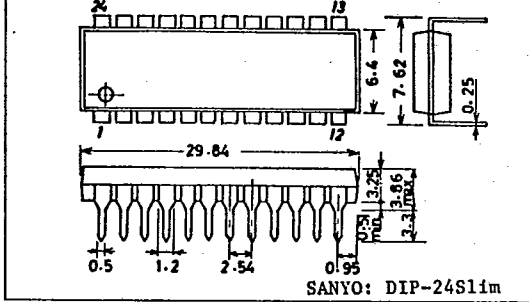

Case Outline—[3063] unit: mm

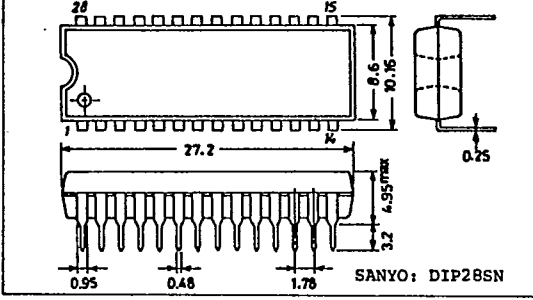

Case Outline—[3118] unit: mm

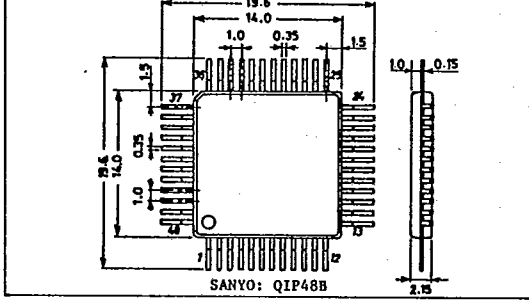

Case Outline—[3067] unit: mm

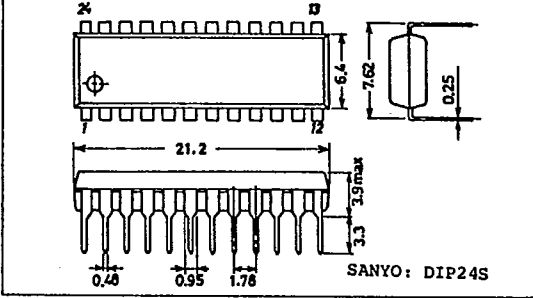

Case Outline—[3073A] unit: mm

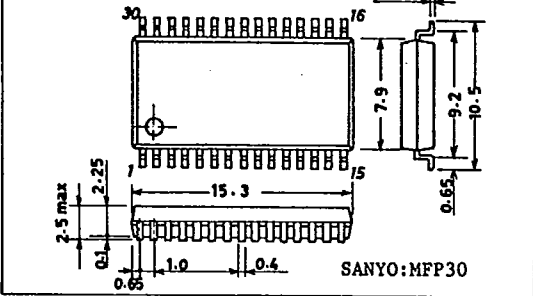

Case Outline—[3074] unit: mm

