

**SANYO**

No.3095A

**LC7367J, 7367JM**

DTMF/PULSE Switchable Dialer

The LC7367J,7367JM are DTMF/OUTPUT-PULSE dialer CMOS LSIs with redial function for use in pushbutton telephones.

### Features

- (1) Low voltage CMOS process for direct operation from telephone line.
- (2) Possible to use single contact or standard 2-of-7, 2-of-8 key pad.
- (3) Possible to use color-burst crystal resonator for on-chip oscillator ( $f_{OSC} = 3.58\text{MHz}$ )
- (4) Possible to use either mode select pin (P/T) or function key (4×4 matrix key) to select DTMF mode/OUTPUT-PULSE mode.
- (5) Mode change with MC key is made in one direction only - from pulse mode to tone mode.
- (6) Delivers 12 DTMF signals when in DTMF mode.
- (7) On-chip 31-digit redial memory
- (8) Possible to provide mix redial (31 digits-PAUSE-MC) of DTMF/OUTPUT-PULSE mode.
- (9) Either auto pause select (4sec.×n) or manual release available for mode select standby time during redial operation.
- (10) Output pulse make rate of OUTPUT-PULSE mode : Pin-selectable (33.2% or 40%)
- (11) Output pulse rate of OUTPUT-PULSE mode : Pin-selectable (10pps or 20pps)
- (12) On-chip circuit to prevent malfunction due to noise pulse caused by key entry.
- (13) Key touch tone (pacifier tone) output capability  
OUTPUT-PULSE mode : 1243Hz/50ms
- (14) Supply voltage / operating temperature  
DTMF mode :  $V_{DD} = 2.0 \text{ to } 6.0\text{V} / T_a = -30 \text{ to } +70^\circ\text{C}$   
OUTPUT-PULSE mode :  $V_{DD} = 1.5 \text{ to } 6.0\text{V} / T_a = -30 \text{ to } +70^\circ\text{C}$
- (15) Operating current  
DTMF mode :  $I_{DD} = 1.0\text{mA max} / V_{DD} = 3.5\text{V}$   
OUTPUT-PULSE mode :  $I_{DD} = 500\mu\text{A max} / V_{DD} = 3.5\text{V}$
- (16) Data retention current  
 $I_{DR} \leq 0.5\mu\text{A} / V_{DD} = 1.0\text{V}$
- (17) Package  
LC7367J : Dual-in-line shrink 22-pin package  
LC7367JM : Miniflat 30-pin package

Package Dimensions 3059 [LC7367J]  
(unit : mm)

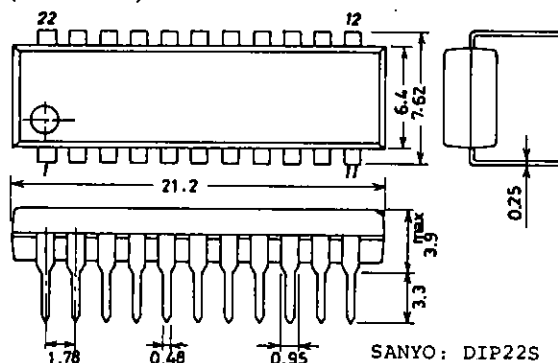

Package Dimensions 3073A [LC7367JM]  
(unit : mm)

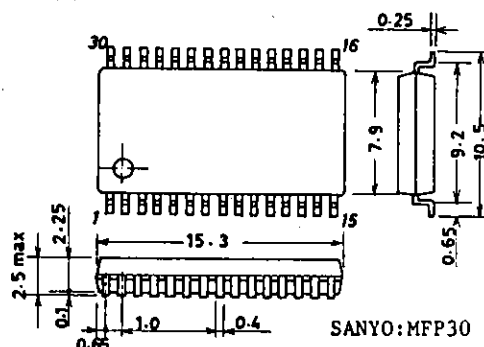

**SANYO Electric Co., Ltd. Semiconductor Business Headquarters**  
TOKYO OFFICE Tokyo Bldg., 1-10, 1 Chome, Ueno, Taito-ku, TOKYO, 110 JAPAN

# LC7367J, 7367JM

## Pin Assignment

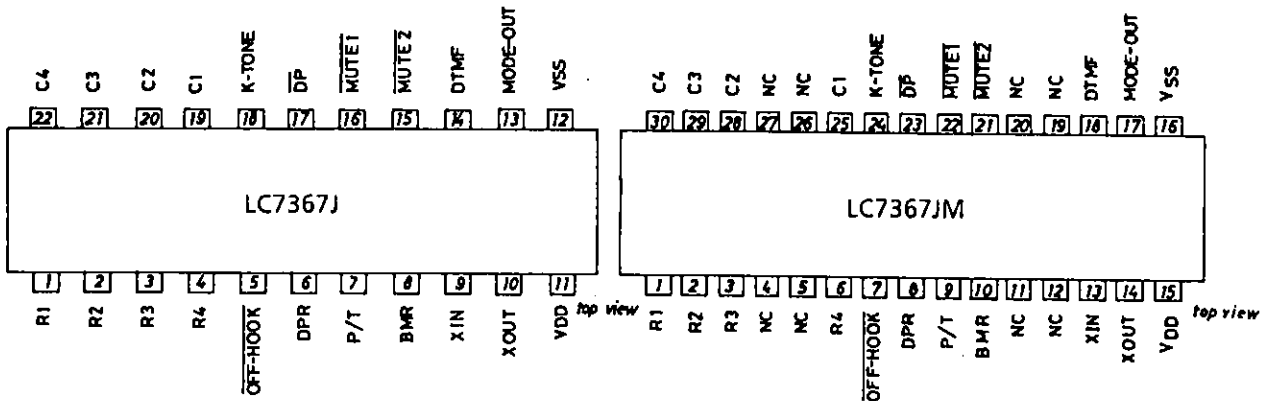

## Equivalent Circuit Block Diagram

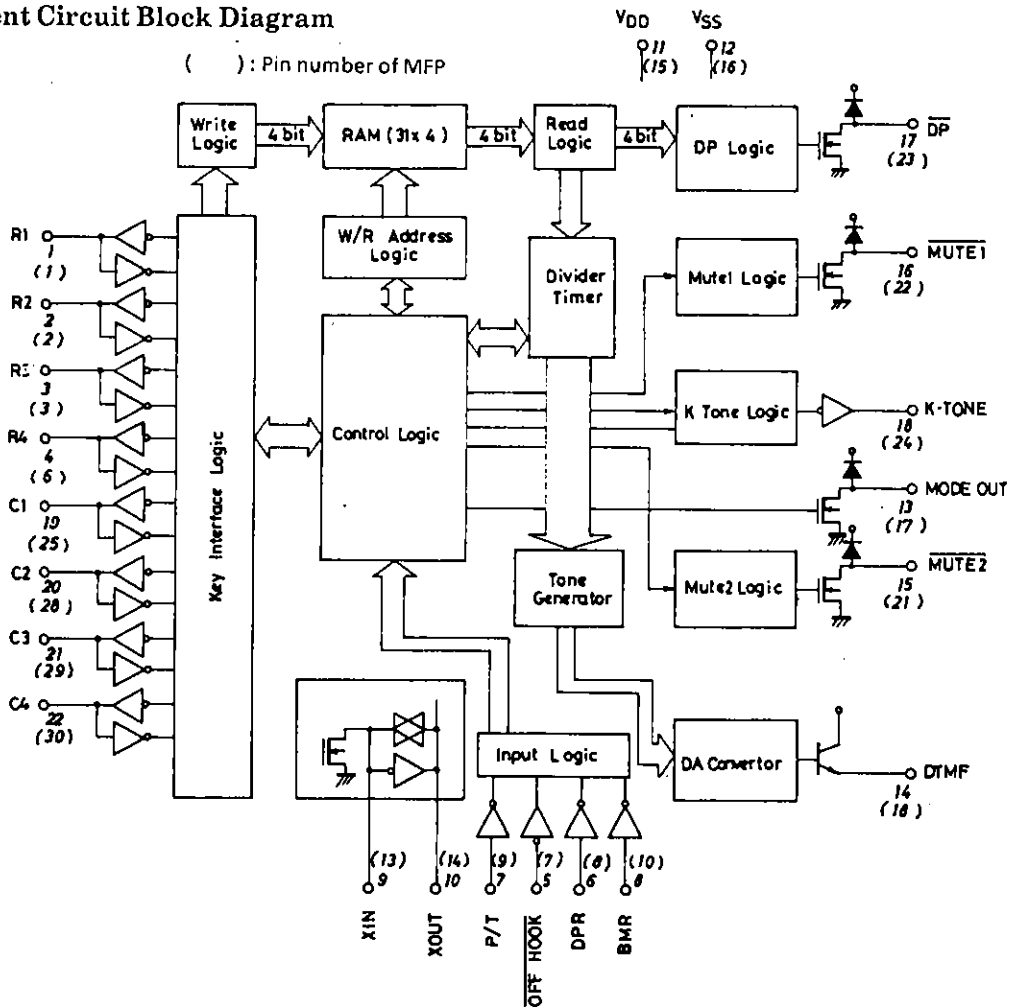

LC7367J, 7367JM

Pin Description ( ): Pin number of MFP

Pin Name	Pin No.	I/O Configuration	Function
V <sub>DD</sub>	11 (15)		Power supply pin.
V <sub>SS</sub>	12 (16)		
X <sub>IN</sub>	9 (13)		<p>Used to generate the reference frequency. Uses a crystal resonator of 3.579545MHz. With the feedback resistor and capacitors contained to form the OSC circuit, a crystal resonator is simply connected across the pins.</p> <p>When using a ceramic resonator, a capacitor of approximately 30pF must be connected to each pin.</p>
X <sub>OUT</sub>	10 (14)		
R1 to R4 C1 to C4	1 to 4 22 to 19 1 to 3 6 25 28 to 30		<p>Row and column input pin. High-active input. Contains a P-channel transistor for keyboard scan and an N-channel transistor for pull-down. When in the ON-HOOK state, the P-channel transistor is turned OFF and the N-channel transistor is turned ON.</p>
OFF-HOOK	5 (7)		<p>HOOK SW input. "H" level = ON-HOOK "L" level = OFF-HOOK</p>
DPR	6 (8)		<p>Dial pulse rate select input. "H" level = 20pps "L" level = 10pps</p>
P/T	7 (9)		<p>Pulse/tone select input. "H" level = Pulse mode "L" level = DTMF mode</p>
BMR	8 (10)		<p>Make rate select input. "H" level = 33.2% "L" level = 40%</p>
DP	17 (23)		<p>Dial pulse output.</p>
MUTE1	16 (22)		<p>Mute output. Operates at the OUTPUT-PULSE mode. Capable of being wired-ORed with MUTE2.</p>
MUTE2	15 (21)		<p>Mute output. Operates at the DTMF mode. Capable of being wired-ORed with MUTE1.</p>
MODE-OUT	13 (17)		<p>DTMF/OUTPUT-PULSE mode output. OUTPUT-PULSE mode = "L" level DTMF mode = "H" impedance</p>
K-TONE	18 (24)		<p>When a key is pushed at the OUTPUT-PULSE mode, the K-TONE (pacifier tone) of 1243Hz/50ms is output.</p>
DTMF	14 (18)		<p>The DTMF signal is output. NPN transistor-used emitter follower output.</p>

Key Assignment

1	2	3	F	R1	F	: Flash	When in OUTPUT-PULSE mode
4	5	6	P	R2	P	: Pause	
7	8	9	RD	R3	RD	: Redial, pause release	
✕	0	#	MC	R4	MC	: Pulse = tone select	
C1	C2	C3	C4				✕ = P
							# = RD

Absolute Maximum Ratings at Ta = 25°C

Maximum Supply Voltage	V <sub>DD</sub>		-0.3 to +7	V
Maximum Input Voltage	V <sub>IN</sub>		-0.3 to V <sub>DD</sub> + 0.3	V
Maximum Output Voltage	V <sub>OUT</sub>		-0.3 to V <sub>DD</sub> + 0.3	V
Allowable Power Dissipation	P <sub>d max</sub>	Ta = 70°C	300	mW
Minimum Load Resistance	R <sub>L min</sub>	Across DTMF and V <sub>SS</sub> pin	100	Ω
Operating Temperature	T <sub>opr</sub>		-30 to +70	°C
Storage Temperature	T <sub>stg</sub>		-40 to +125	°C

Allowable Operating Conditions at Ta = -30 to +70°C, V<sub>DD</sub> = 1.5 to 6.0V

Supply Voltage	V <sub>DDP</sub>	OUTPUT-PULSE mode	min 1.5	typ 6.0	max 6.0	unit V
	V <sub>DDT</sub>	DTMF mode	min 2.0	typ 6.0	max 6.0	unit V
'H'-Level Input Voltage	V <sub>IH</sub>	All input pins	min 0.7V <sub>DD</sub>	typ V <sub>DD</sub>	max V <sub>DD</sub>	unit V
'L'-Level Input Voltage	V <sub>IL</sub>	All input pins	min V <sub>SS</sub>	typ 0.3V <sub>DD</sub>	max 0.3V <sub>DD</sub>	unit V
Key Contact Resistance	R <sub>KI</sub>				max 3.0	unit kΩ
Keyboard Capacitance	C <sub>KI</sub>				max 330	unit pF
Resonator Specification	f		3.579545MHz ± 0.7%			
	R <sub>S</sub>		< 100Ω			

Electrical Characteristics at Ta = 25°C, V<sub>DD</sub> = 1.5 to 6.0V

Operating Current	I <sub>DDP</sub>	OUTPUT-PULSE mode, output open, V <sub>DD</sub> = 3.5V	min	typ 0.3	max 0.5	unit mA
	I <sub>DDT</sub>	DTMF mode, output open, V <sub>DD</sub> = 3.5V		typ 0.5	max 1.0	unit mA
Quiescent Current	I <sub>DD(ST)</sub>	OFF-HOOK pin = V <sub>DD</sub> , V <sub>DD</sub> = 1.5 to 6.0V, output open			max 1	unit μA
Data Retention Voltage	V <sub>DR</sub>				max 1	unit V
Data Retention Current	I <sub>DR</sub>	V <sub>DD</sub> = 1V			max 0.5	unit μA
'H'-Level Input Current	I <sub>IH</sub>	(OFF-HOOK, DPR, P/T, BMR) pin, V <sub>IH</sub> = V <sub>DD</sub>			max 1	unit μA
'L'-Level Input Current	I <sub>IL</sub>	(OFF-HOOK, DPR, P/T, BMR) pin, V <sub>IL</sub> = V <sub>SS</sub>	min -1			unit μA
Key Pin Current	I <sub>IHK</sub>	V <sub>DD</sub> = 1.5V, V <sub>IH</sub> = V <sub>DD</sub>			max 20	unit μA
		V <sub>DD</sub> = 6.0V, V <sub>IH</sub> = V <sub>DD</sub>			max 300	unit μA
	I <sub>OHK</sub>	V <sub>DD</sub> = 1.5V, V <sub>OH</sub> = 0.8V <sub>DD</sub>			max -50	unit μA
		V <sub>DD</sub> = 6.0V, V <sub>OH</sub> = 0.8V <sub>DD</sub>			max -700	unit μA
Output OFF-State Leakage Current	I <sub>OFF</sub>	V <sub>O</sub> = V <sub>DD</sub> , V <sub>DD</sub> = 6V, output OFF, (DP, MUTE1, MUTE2, MODE-OUT)			max 1	unit μA

Continued on next page.

## LC7367J, 7367JM

Continued from preceding page.

			min	typ	max	unit
'H'-Level Output Pin Voltage	$V_{OH}$	K-TONE : $V_{DD}=1.5V$ , $I_{OH}=-125\mu A$	$V_{DD}-0.5$			V
		K-TONE : $V_{DD}=3.5V$ $I_{OH}=-500\mu A$	$V_{DD}-1$			V
'L'-Level Output Pin Voltage	$V_{OL}$	[(K-TONE, DP, MUTE1, MUTE2, MODE-OUT) pin]	$V_{DD}=1.5V, I_{OL}=125\mu A$		0.4	V
			$V_{DD}=3.5V, I_{OL}=500\mu A$		0.4	V

AC Characteristics at  $T_a=25^\circ C, V_{DD}=1.5$  to  $6.0V, f_{OSC}=3.579545MHz$

			min	typ	max	unit
Key Debounce Time	$T_{KD}$		10.8		11.6	ms
K-TONE Frequency	$f_{KT}$			1243		Hz
K-TONE Output Time	$T_{KT}$			50.9		ms
Auto Pause Time	$T_{AP}$			3.99		s
Single Tone Output	$V_{OR}$	ROW TONE output, $V_{DD}=3.5V$ , $R_L=10k\Omega$	170	205	245	mVrms
Tone Output Ratio	dBCR	$V_{DD}=2$ to $6V, R_L=10k\Omega$	1	2	3	dB
Tone Output Distortion	%DIS	$V_{DD}=2.5$ to $6V, R_L=10k\Omega$ , $f=300$ to $3400Hz$			7	%
		$V_{DD}=2$ to $6V, R_L=10k\Omega$ , $f=300$ to $3400Hz$			10	%
Oscillation Start Time	$T_{START}$	$V_{DD}=1.7$ to $6V$			20	ms
		$V_{DD}=3.5V$			8	ms
DTMF Output Time	$T_{MFON}$		97.6			ms
DTMF Interdigit Pause	$T_{MFOFF}$		100.6			ms
Flash Time	$T_{FLASH}$			605		ms

### • Dial Pulse Output

$f_{osc}=3.579545MHz$

Pin DPR	Pin BMR	Dial Pulse Rate	Interdigit Pause	Make Ratio
VSS	VDD	9.94 PPS	838.1 ms	33.2 %
VDD	VDD	19.89 PPS	519.6 ms	33.2 %
VSS	VSS	9.94 PPS	844.8 ms	40 %
VDD	VSS	19.89 PPS	523.0 ms	40 %

### • DTMF Output

$f_{osc}=3.579545MHz$

Input	Output Frequency (Hz)		Deviation (%)
	Standard	LC7367J, 7367JM	
R1	697	699.1	+0.30
R2	770	766.2	-0.49
R3	852	847.4	-0.54
R4	941	948.0	+0.74
C1	1209	1215.9	+0.57
C2	1336	1331.7	-0.32
C3	1477	1471.9	-0.35

### • Redial Operation

$f_{osc}=3.579545MHz$

Parameter	Time	
	1st Digit	2nd Digit onward
DTMF Output	97.6 ms	100.6 ms
Interdigit Pause	100.6 ms	100.6 ms
Period	198.2 ms	201.2 ms

Timing Charts

(1) OUTPUT-PULSE mode

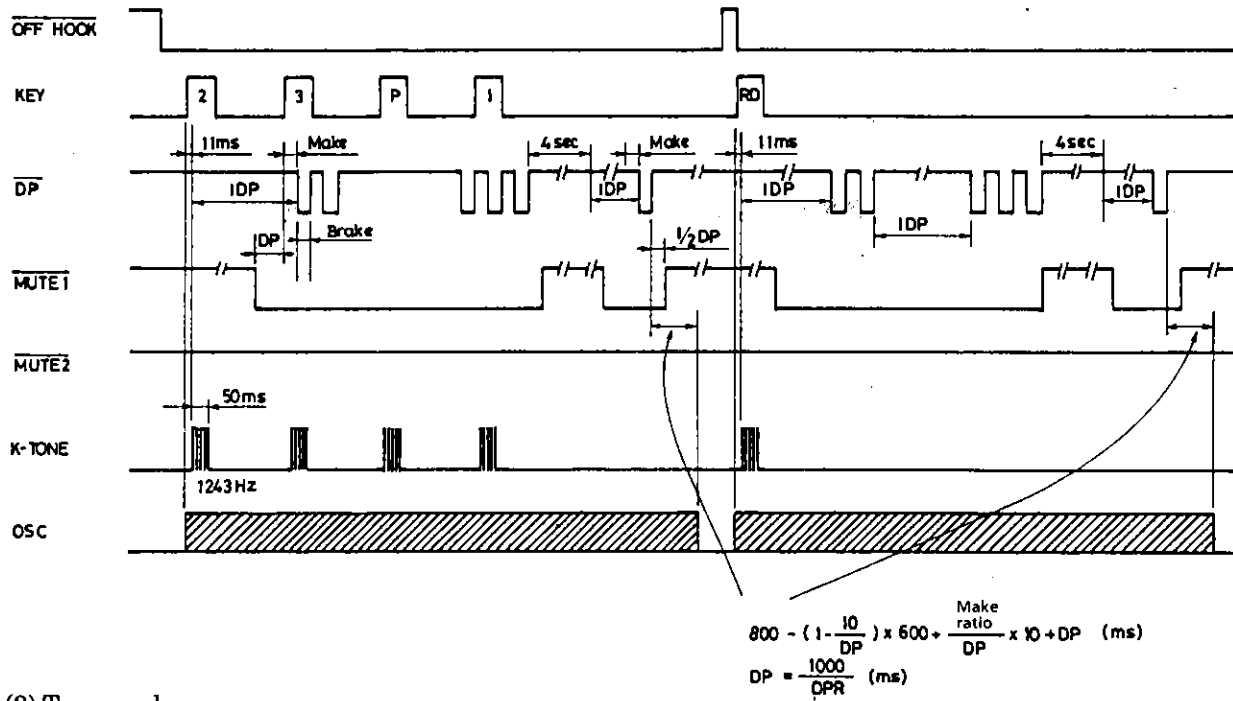

(2) Tone mode

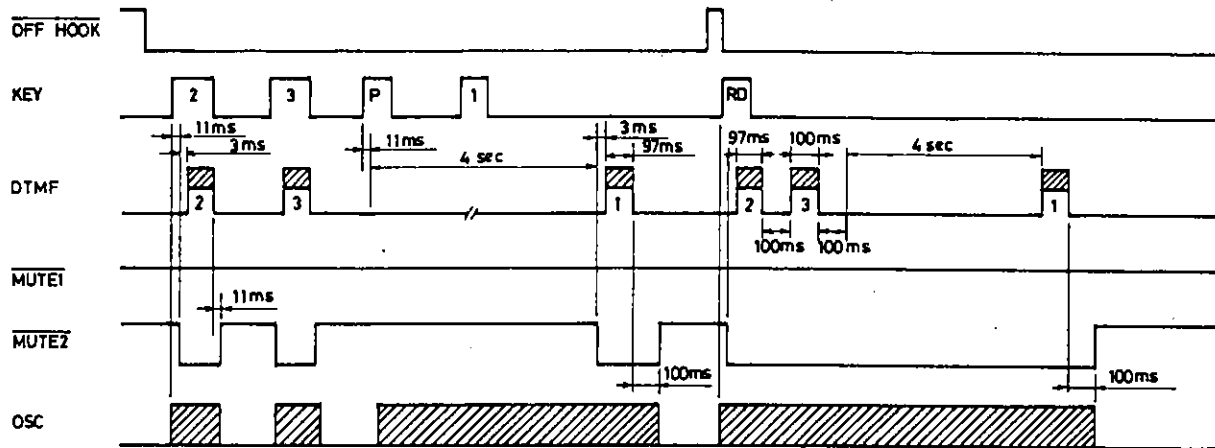

(3) Pulse → tone mix (P/T = 'H')

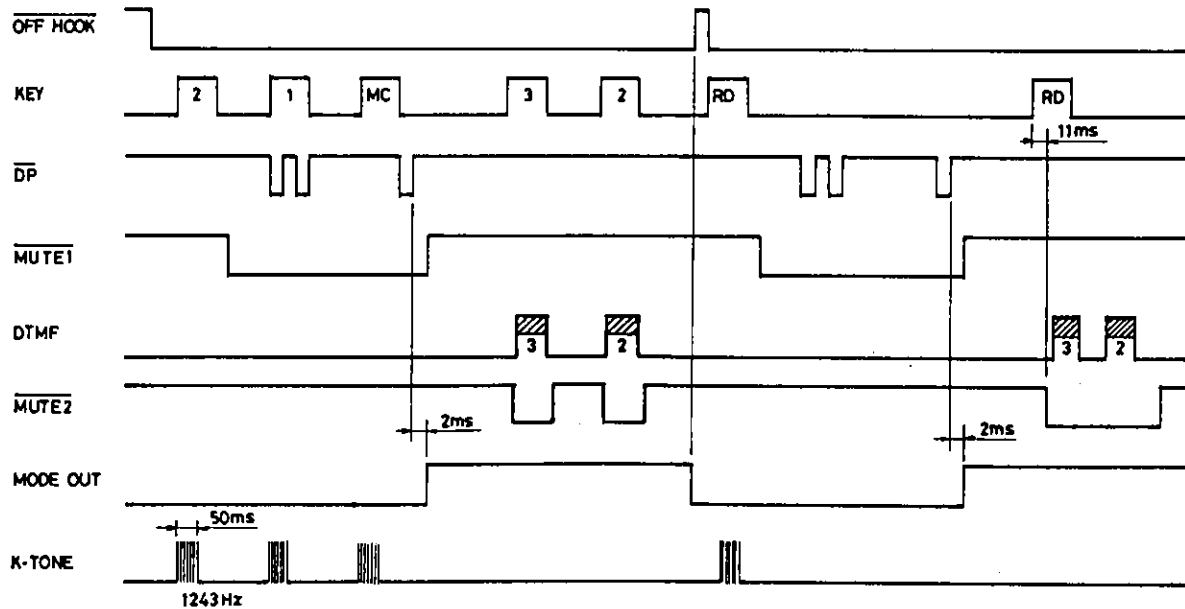

(4) Pulse → tone (P/T = 'H')

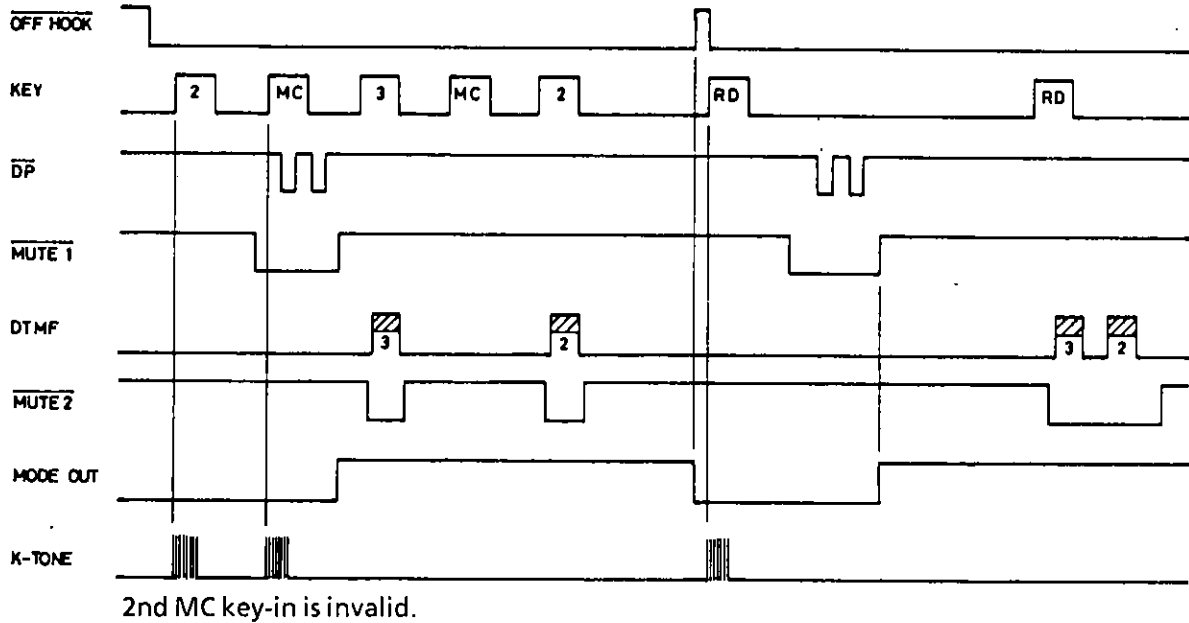

(5) Timing of flash

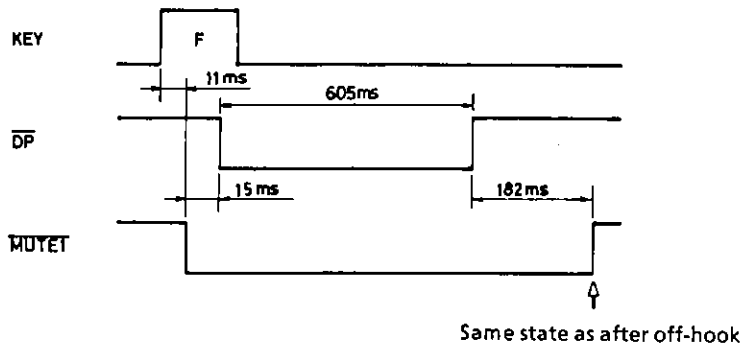

(6) Mix dial and redial (key entry available after redial) by P/T input (slide SW, etc.)

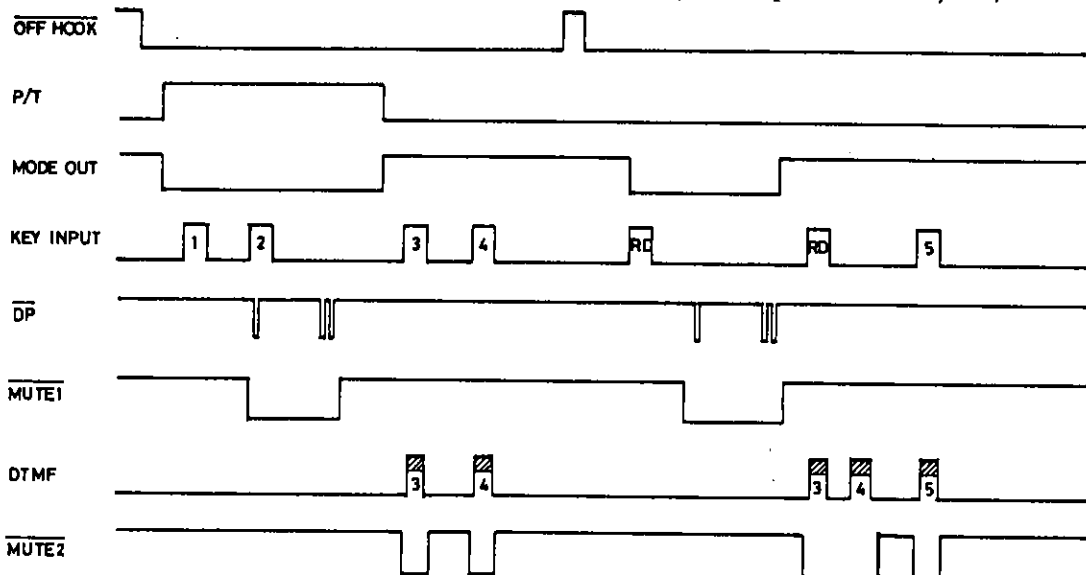

- Even when the tone mode (P/T SW : "Tone") is entered at the OFF-HOOK state, the OUTPUT-PULSE mode can be entered (P/T SW : "Pulse").
- The output mode provided when redialing is the one provided when dialed previously (regardless of the P/T SW position when the RD key is pushed).

Continued on next page.

Continued from preceding page.

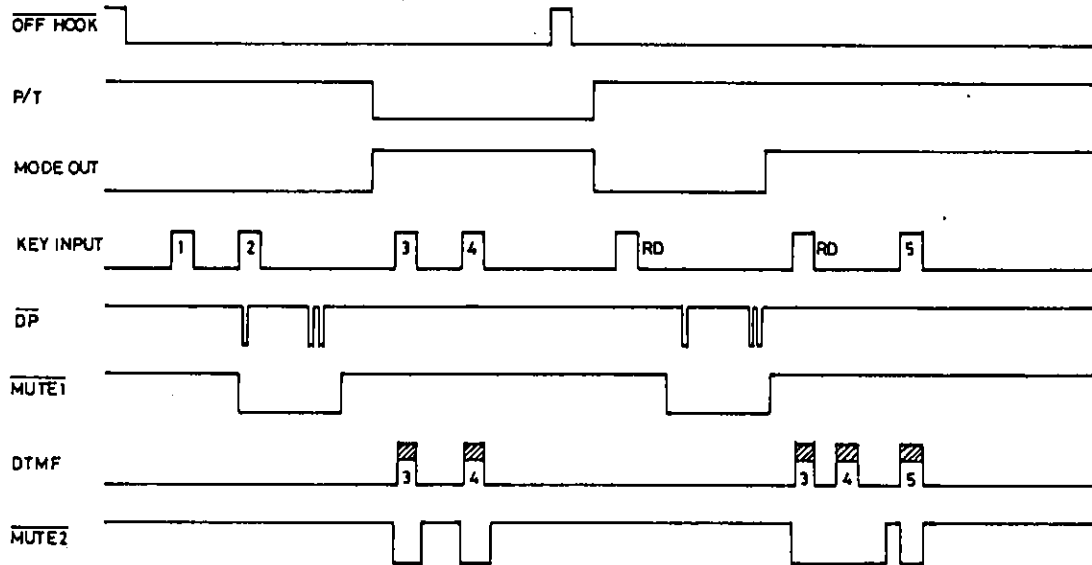

- The mode after completion of redialing is set again by the P/T SW position provided when redialing is completed.

Since the DP, MUTE1, MUTE2, MODE-OUT outputs are of the Nch open drain type, the output transistor OFF-state ("H" impedance) provides "H" level.

Likewise, since the DTMF output is of the emitter follower type, the output transistor OFF-state ("H" impedance) provides "L" level.

**Key Operation**

(1) Normal dial

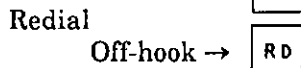
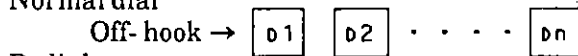

(2) PBX dial

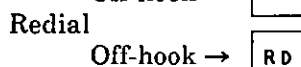
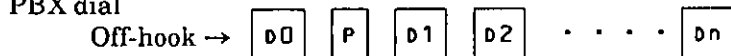

(3) Pulse/tone mix

① In case where there is no pause during mode select

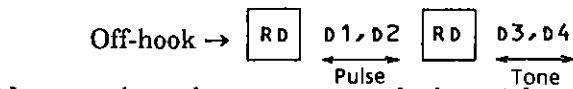
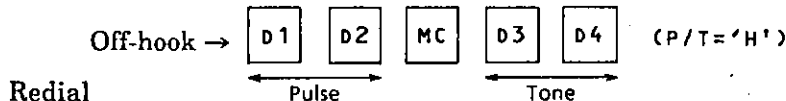

② In case where there are pauses during mode select

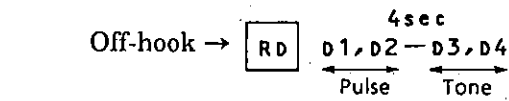
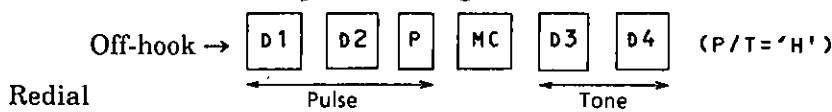

(Note) ② When in OUTPUT-PULSE mode P = X      RD = #

③ Pause : 4sec. / 1 push of [P] , 8sec. / 2 pushes of [P] ,  
4 × nsec. / n pushes of [P]

④ For pause release, push [RD] . All pauses can be also released by pushing [RD] once.



## Function Specifications

The LC7367J, 7367JM are capable of pulse dial, DTMF dial and also both types of dialing mixed, as well as redial of these.

### 1) Dial Output Specifications

- The output pulse make ratio of OUT-PULSE mode can be set at 33.2 or 40% using the BMR pin.
- The output pulse rate of OUT-PULSE mode can be set at 20 or 10pps using the DPR pin.
- 12 types of DTMF dial signals (1 to 0, \*, #) are generated in DTMF mode.
- DTMF signals are output continuously when the keys are pressed.
- A minimum output for DTMF of approximately 100ms, and also about 100ms for minimum IDP are guaranteed.

### 2) Summary of Operation

- Key input data is written consecutively in the 31 digit buffer memory (also used as RD memory; hereinafter referred to as RD memory).
- The dial data in the RD memory is read out according to the set dial rate, and is output at the  $\overline{DP}$  and DTMF pins.
- Dial output of more than 31 digits is enabled by rewriting the key data from the top (address 0) of the RD memory.
- Because of this, the correct dial does not remain in the RD memory for 32 digits or more, so redial for 32 digits or more is prohibited.
- Dial data (1 to 0, \*, #), mode change data (MC) and pause data (P) are written in the RD memory as 1 digit each.
- Dial output mode switching can be performed using the MC key on the key matrix or the P/T input pin.
- The dial output can be stopped for 4 seconds with the pause key (P).
- One-touch redial can be done using the redial key (RD).

### 3) Key and P/T Pin Descriptions

#### ① Keys 1 to 0

These are dial data keys. Data is written in the RD memory.

#### ② \*, # Keys

In DTMF mode : \* and # dial data key

In OUT-PULSE mode : \* = pause key (P)

# = redial key (RD)

The \* and # keys for DTMF mode and \* key in the OUT-PULSE mode are for writing data in the RD memory.

#### ③ F Key (flash key)

• The same operation as for 0.6-second hooking is performed when  $\overline{DP}$  output is turned on for 0.6 second.

• Redial can be performed after flash operation.

#### ④ RD Key (redial key)

##### 1. Redial operation

When the RD key is pressed after hooking ( $\overline{OFF-HOOK}$  pin) or F key operation, the number that immediately precedes will be redialed.

Redial is prohibited if the number has 32 digits or more.

##### 2. Pause release

The Pause key provides 4-second pause and releases pause attendant on the mode change (MC key, P/T pin).

Even if there is a succession of 2 digits or more of pause data in the RD memory, it will all be released.

#### ⑤ P Key (pause key)

• Stops dial output for 4 seconds.

• Data is written in the RD memory.

Continued on next page.

Continued from preceding page.

Ⓒ MC Key (mode change key)

- Switches dial mode from OUT-PULSE mode to DTMF mode.
- The mode cannot be switched from DTMF mode to OUT-PULSE mode.

Ⓓ P/T Pin

- Input to indicate dial mode  
 H = OUT-PULSE mode  
 L = DTMF (tone) mode
- The mode can be switched between DTMF and pulse mode differ from in case of MC key.
- Mix dialing by P/T pin switching during dialing is possible. MD data is written in the RD memory at this time.
- At OUT-PULSE mode, if the MC key is pressed during dialing, data is written in the RD memory as MC data.
- At OUT-PULSE mode, pressing the first digit (after OFF-HOOK) MC key switches the dial mode, but data is not written in the RD memory.

Key Assignment

	C1	C2	C3	C4
R1	1	2	3	F
R2	4	5	6	P
R3	7	8	9	RD
R4	*	0	#	MC

Key Debounce Time

- A key debounce circuit is built in key input to prevent misoperation caused by switch chattering. Input is valid when on continuously for 11ms or more, and is invalid when off continuously for 11ms or more.

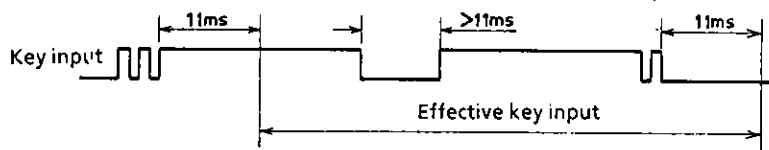

4) MC Data Writing in RD Memory

- After the MC data is stored once in the MC data flag, it is written in the RD memory when another data key (1 to 0, \*, #, P) is pressed.
- The MC data flag is reset with hooking and the P key.
- The contents of the MC data flag are canceled and are not written in the RD memory when the P/T pin is switched as P→T→P.

5) Notes on Dial Specifications

① Pause operation during mode switching

When there is no P data before or after MC data

1. Normal dial

Mode change is done and DTMF data key is started during dial pulse output:

→ After dial pulse ends, pause begins, and the DTMF signal is output with release using the RD key.

DTMF data keyed in after dial pulse output :

→ DTMF signal is output with key-in.

2. Redial for the above

After dial pulse ends, pause begins, and the DTMF signal is output with release using the RD key.

Continued on next page.

Continued from preceding page.

② Key input during redial

This is ignored except for the F key and the RD key during pause operation.

6) Test Mode

A high speed test mode is provided in order to reduce the LSI test time.

- Test mode setting and release methods

BMR pin input

OFF-HOOK pin input

+ built-in power-on reset pulse

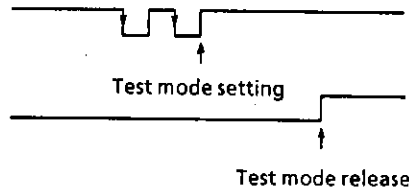

- Test mode summary

The internal divider circuit (72 divisions) is bypassed.

Key scan frequency	.....	72 times
Dial pulse rate	.....	72 times
4-second pause	.....	1/72

■ No products described or contained herein are intended for use in surgical implants, life-support systems, aerospace equipment, nuclear power control systems, vehicles, disaster/crime-prevention equipment and the like, the failure of which may directly or indirectly cause injury, death or property loss.

■ Anyone purchasing any products described or contained herein for an above-mentioned use shall:

- ① Accept full responsibility and indemnify and defend SANYO ELECTRIC CO., LTD., its affiliates, subsidiaries and distributors and all their officers and employees, jointly and severally, against any and all claims and litigation and all damages, cost and expenses associated with such use;
- ② Not impose any responsibility for any fault or negligence which may be cited in any such claim or litigation on SANYO ELECTRIC CO., LTD., its affiliates, subsidiaries and distributors or any of their officers and employees jointly or severally.

■ Information (including circuit diagrams and circuit parameters) herein is for example only; it is not guaranteed for volume production. SANYO believes information herein is accurate and reliable, but no guarantees are made or implied regarding its use or any infringements of intellectual property rights or other rights of third parties.

