

**SANYO****LC7461M****Infrared Remote Control Transmitter IC****Functions**

- 32⊕3 function keys
- 13-bit custom codes
- Operating supply voltage range  $V_{DD} = 1.8$  to 3.6 V
- Supply current at the standby mode  $I_{DD} = 1 \mu\text{A}$  or less
- Double-press operation keys (no priority given)
- On-chip oscillator (ceramic resonator : connected externally)

**Features**

- The custom code consists of 7 bits to be fixed by the on-chip ROM and 6 bits being pin-settable. Sixty-four custom codes may be selected externally (no diode required).
- Minimum number of external parts required

**Package Dimensions**

unit : mm

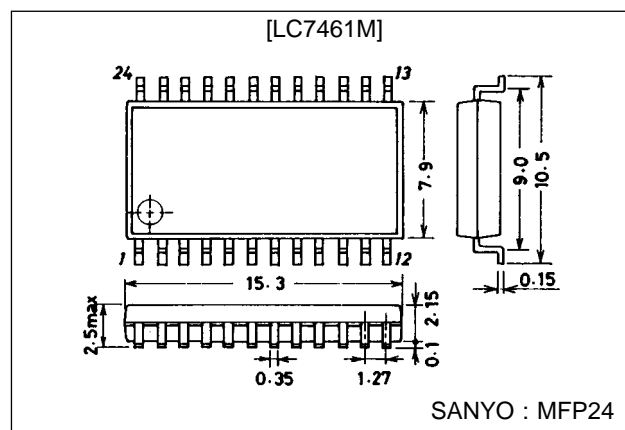
**3045B-MFP24****Specifications****Absolute Maximum Ratings at  $T_a = 25^\circ\text{C}$** 

Parameter	Symbol	Conditions	Ratings	Unit
Maximum supply voltage	$V_{DD \text{ max}}$	$V_{DD}$	$V_{SS}-0.3$ to $+5.5$	V
Input voltage	$V_{IN}$	Each input pin	$V_{SS}-0.3$ to $V_{DD}+0.3$	V
Output voltage	$V_{OUT}$	Each output pin	$V_{SS}-0.3$ to $V_{DD}+0.3$	V
Output current	$I_{OUT}$	OUT	-35	mA
Allowable power dissipation	$P_d \text{ max}$	$T_a \leq 85^\circ\text{C}$	150	mW
Operating temperature	$T_{opr}$		-40 to +85	$^\circ\text{C}$
Storage temperature	$T_{stg}$		-50 to +125	$^\circ\text{C}$

**Allowable Operating Conditions at  $T_a = 25^\circ\text{C}$** 

Parameter	Symbol	Pin Name	Conditions	min	typ	max	Unit
Supply voltage	$V_{DD}$	$V_{DD}$	$f_{OSC} = 455 \text{ kHz}$	1.8	3.0	3.6	V
Input high-level voltage	$V_{IH}$	$K_10$ to $K_13$ , $C_0$ to $C_5$		$0.7 V_{DD}$		$V_{DD}$	V
Input low-level voltage	$V_{IL}$	$K_10$ to $K_13$ , $C_0$ to $C_5$		$V_{SS}$		$0.3V_{DD}$	V
Oscillation frequency	$f_{OSC}$			400	455	500	kHz

# LC7461M

## Electrical Characteristics at $T_a = 25^\circ\text{C}$ , $V_{DD} = 3.0\text{ V}$

Parameter	Symbol	Pin Name	Conditions	min	typ	max	Unit
Operating supply current	$I_{DD}$	$V_{DD}$	Key ON, output: no load			1	mA
Quiescent supply current	$I_{DS}$	$V_{DD}$	All keys OFF, OSC stop			1	$\mu\text{A}$
Output high-level current	$I_{OH1}$	OUT	$V_{DD} = 1.8\text{ V}$ , $V_{OH} = 1.0\text{ V}$		-8		mA
	$I_{OH2}$	OUT	$V_{DD} = 3.0\text{ V}$ , $V_{OH} = 1.0\text{ V}$		-25		mA
Output high-level voltage	$V_{OH}$	$K_0$ 0 to $K_0$ 7	$I_{OH} = -0.1\text{ mA}$			0.3	V
Output low-level voltage	$V_{OL}$	OUT	$I_{OL} = 0.1\text{ mA}$			0.3	V
Output OFF-state leakage current	$I_{OFF}$	$K_0$ 0 to $K_0$ 7				1	$\mu\text{A}$
Input high-level current	$I_{IH}$	$C_0$ to $C_5$	$V_{IN} = V_{DD}$			1	$\mu\text{A}$
Input low-level current	$I_{IL}$	$C_0$ to $C_5$	$V_{IN} = V_{SS}$	-1			$\mu\text{A}$
Input floating voltage	$V_{IF}$	$K_1$ 0 to $K_1$ 3				$0.1 V_{DD}$	V
Input pull down resistance	$R_{IN}$	$K_1$ 0 to $K_1$ 3		75	100	125	k $\Omega$

## Internal Block Diagram

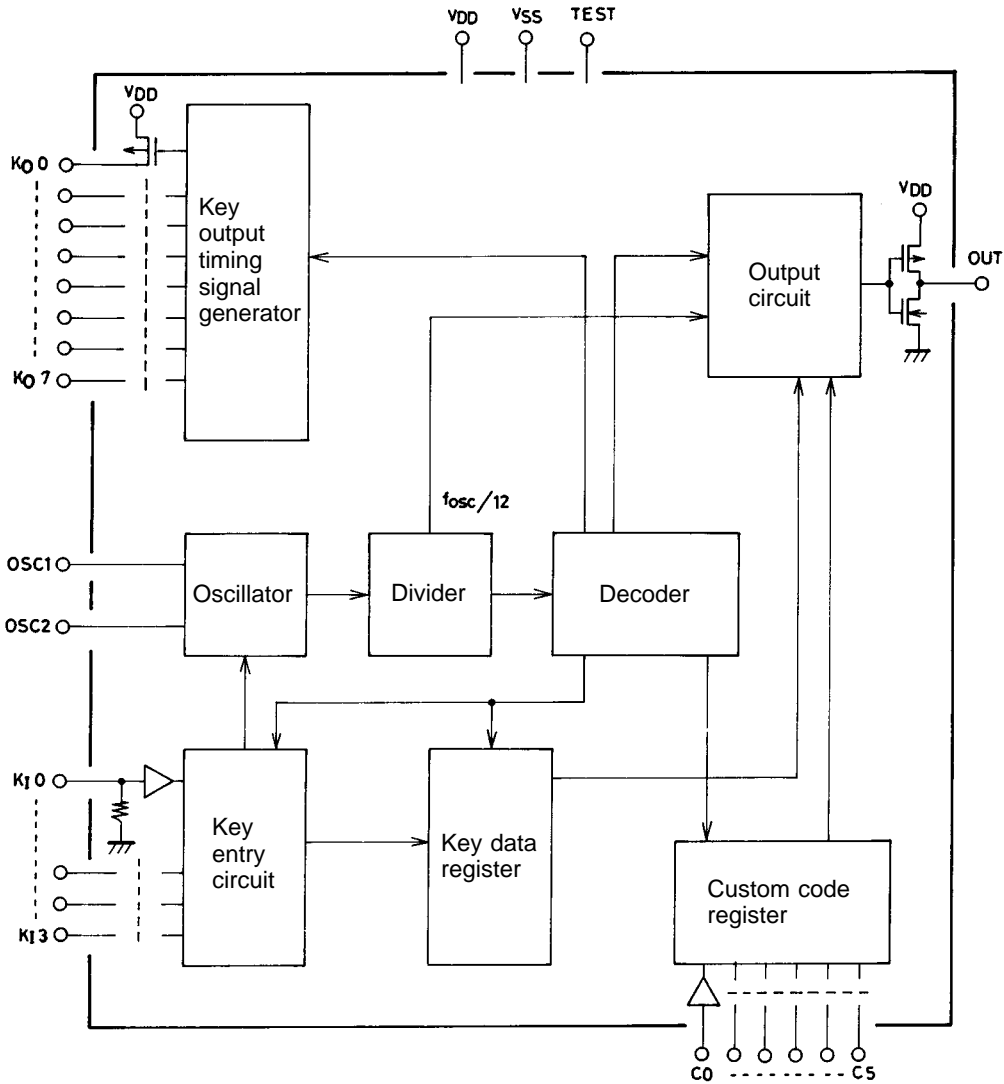

# LC7461M

## Pin Assignment

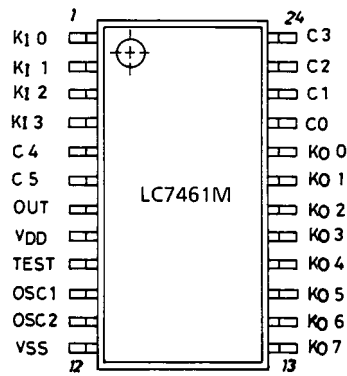

Top view

## Pin Description

Pin Name	Pin No.	Input/Output	Internal Equivalent Circuit	Pin Function
V <sub>DD</sub> , V <sub>SS</sub>	8, 12			Power supply pins V <sub>SS</sub> = GND
K <sub>O</sub> 0 to K <sub>O</sub> 7	13 to 20	Output		Key scan timing signal output pins
K <sub>I</sub> 0 to K <sub>I</sub> 3	1 to 4	Input		Keys return signal entry pins
OSC1 OSC2	10 11	Input/output		Input/output pins for ceramic resonator-used oscillation
C <sub>0</sub> to C <sub>5</sub>	21 to 24, 5, 6	Input		Input pins for custom code setting Capable of externally setting 6 bits of 13 bits in all that provide a custom code
OUT	7	Output		Output pin for transmit LED drive
TEST	9	Input		LSI test pin Normally set to high-level or brought to open state

**General Description of Function**

1. Oscillator  
 Since a self-bias type amplifier of CMOS inverter is contained, an oscillator can be formed by connecting a ceramic resonator.

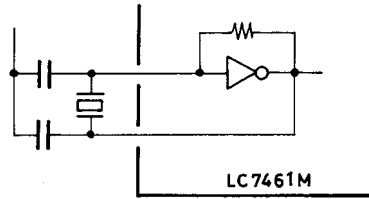

To minimize power dissipation, the oscillator stops oscillating except when key operation is performed.

2. Key entry  
 Key entry pins  $K_{I0}$  to  $K_{I3}$  and timing signal output pins  $K_{O0}$  to  $K_{O7}$  provide a key matrix of  $4 \times 8 = 32$ .

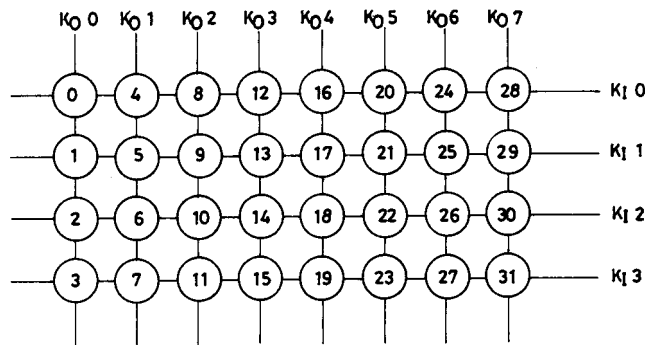

Multi-press of key No. 20 and one of key No. 21, 22, 23 may be done, with no priority given in key entry. When the two keys are kept pressed, a series of pulses will be output according to each key entry. If multi-press of keys which are not allowed multi-press is done, no output will be delivered.

3. Data organization  
 Data consists of 42 bits in all: 13 bits of custom code, 8 bits of key data, and their inverted codes.

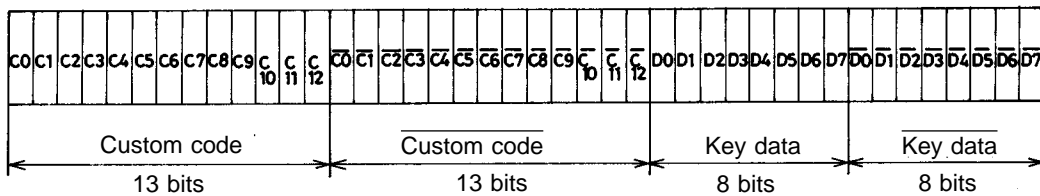

# LC7461M

(a) Custom code

The custom code, which consists of 13 bits ( $C_0$  to  $C_{12}$ ) in all, is used to distinguish between receiving sets.

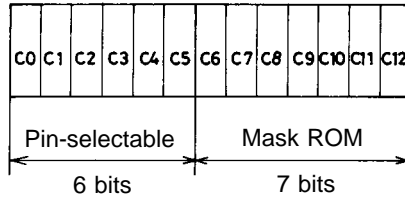

$C_6$  to  $C_{12}$  are fixed by the mask ROM and  $C_0$  to  $C_5$  are pin-settable.

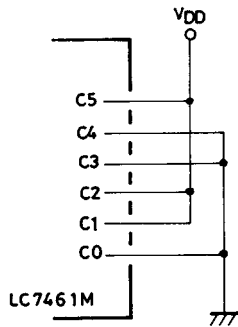

In this example  $C_0$  to  $C_5$  are set as follows:

$C_0$	$C_1$	$C_2$	$C_3$	$C_4$	$C_5$
0	1	1	0	0	1

The custom codes are controlled by Sanyo to avoid duplication.

(b) Key data

KEY No.	D <sub>0</sub>	D <sub>1</sub>	D <sub>2</sub>	D <sub>3</sub>	D <sub>4</sub>	D <sub>5</sub>	D <sub>6</sub>	D <sub>7</sub>
0	0	0	0	0	0	0	0	0
1	1	0	0	0	0	0	0	0
2	0	1	0	0	0	0	0	0
3	1	1	0	0	0	0	0	0
4	0	0	1	0	0	0	0	0
5	1	0	1	0	0	0	0	0
⋮	⋮	⋮	⋮	⋮	⋮	⋮	⋮	⋮
28	0	0	1	1	1	0	0	0
29	1	0	1	1	1	0	0	0
30	0	1	1	1	1	0	0	0
31	1	1	1	1	1	0	0	0

Multi-press

KEY No.	D <sub>0</sub>	D <sub>1</sub>	D <sub>2</sub>	D <sub>3</sub>	D <sub>4</sub>	D <sub>5</sub>	D <sub>6</sub>	D <sub>7</sub>
20, 21	1	0	1	0	1	1	0	0
20, 22	0	1	1	0	1	1	0	0
20, 23	1	1	1	0	1	1	0	0

- $D_6, D_7$  may be preset to "0", "1" beforehand (mask option).

When multi-press of key No.20 and one of key No.21, 22, 23 is done, multi-bit  $D_5$  will be set to "1", with no priority given in key entry.

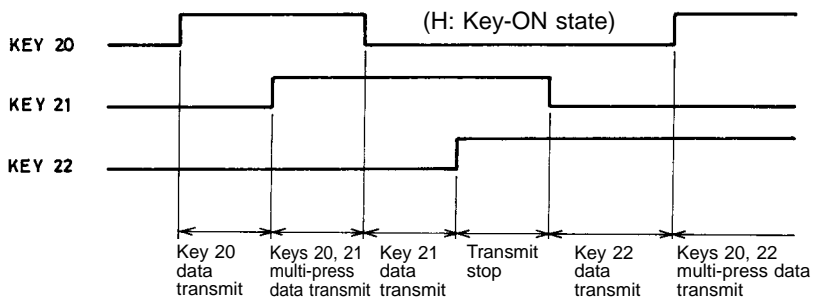

# LC7461M

## 4. Transmit waveforms

The period of time shown below is for  $f_{OSC} = 455 \text{ kHz}$ .

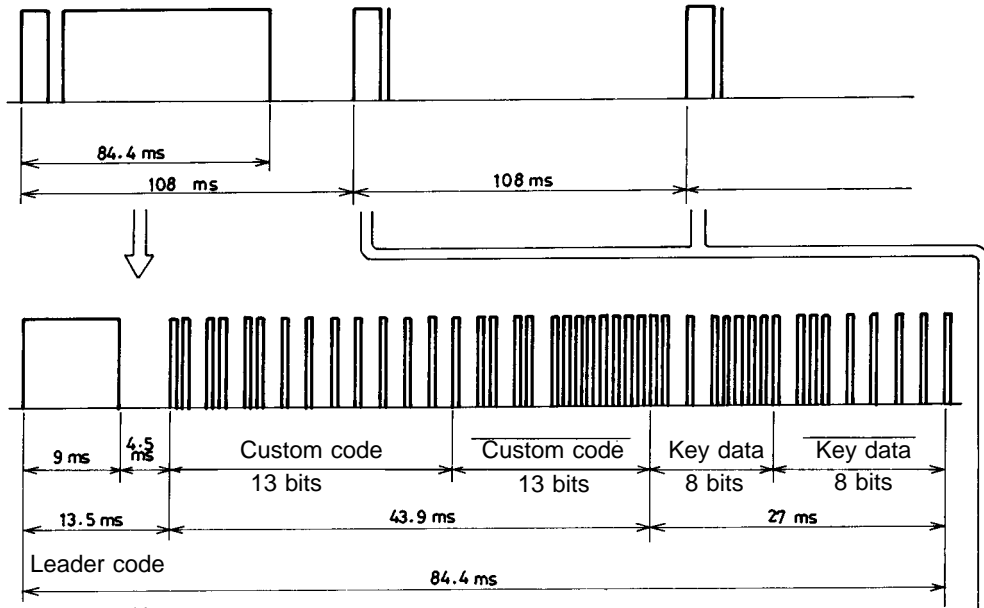

• First time

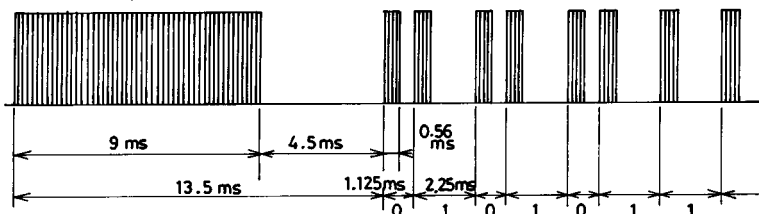

• Second time onward (Transmission is available only when key entry continues.)

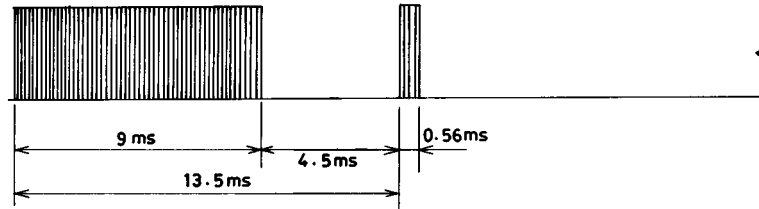

• Carrier waveform

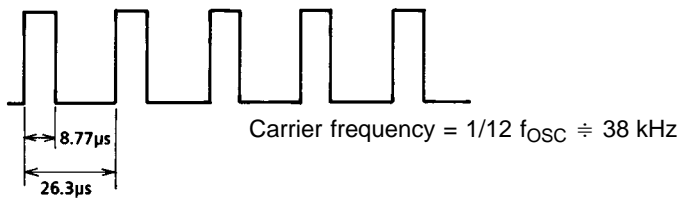

Sample Application Circuit

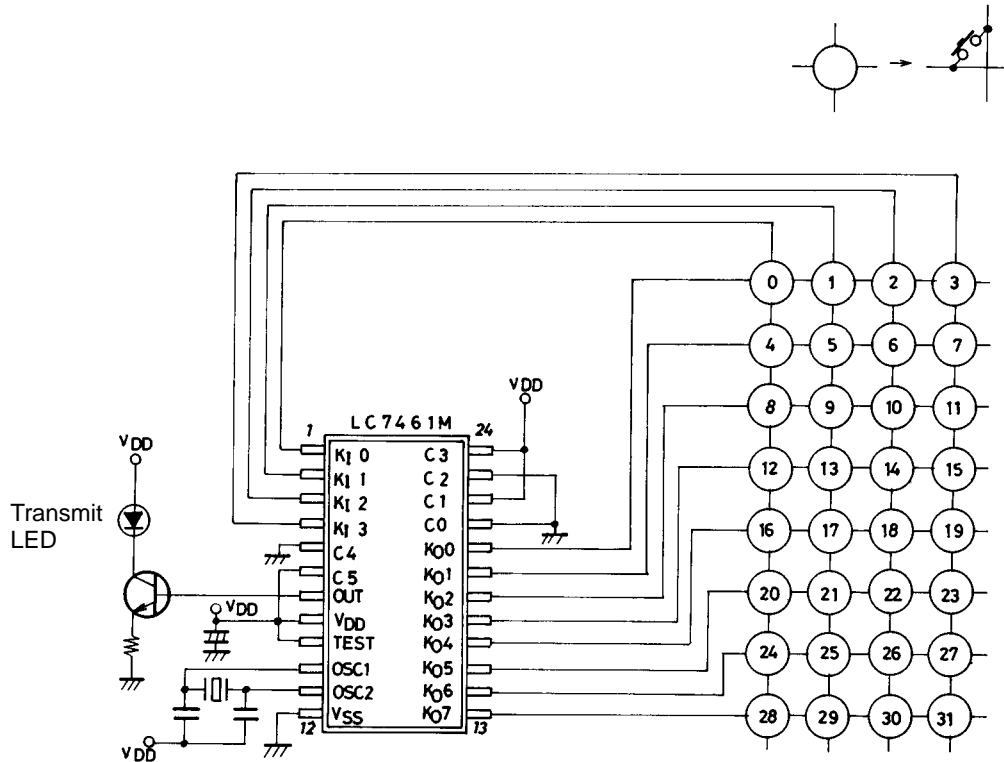

In this example custom code  $C_0$  to  $C_5$  is  $C_0 \cdots C_5$ .  
0 1 0 1 0 1

- No products described or contained herein are intended for use in surgical implants, life-support systems, aerospace equipment, nuclear power control systems, vehicles, disaster/crime-prevention equipment and the like, the failure of which may directly or indirectly cause injury, death or property loss.
- Anyone purchasing any products described or contained herein for an above-mentioned use shall:
  - ① Accept full responsibility and indemnify and defend SANYO ELECTRIC CO., LTD., its affiliates, subsidiaries and distributors and all their officers and employees, jointly and severally, against any and all claims and litigation and all damages, cost and expenses associated with such use:
  - ② Not impose any responsibility for any fault or negligence which may be cited in any such claim or litigation on SANYO ELECTRIC CO., LTD., its affiliates, subsidiaries and distributors or any of their officers and employees jointly or severally.
- Information (including circuit diagrams and circuit parameters) herein is for example only; it is not guaranteed for volume production. SANYO believes information herein is accurate and reliable, but no guarantees are made or implied regarding its use or any infringements of intellectual property rights or other rights of third parties.

This catalog provides information as of October, 1996. Specifications and information herein are subject to change without notice.