



LC75348, 75348M

Single-Chip Electronic Volume and Tone Control System



Overview

The LC75348 and LC75348M are electronic volume and tone control ICs that provide volume, balance, 2-band equalizer, input gain control, and input switching functions while requiring a minimal number of external components.

Functions

- Volume: 81 levels: 0 dB to -79 dB (in 1 dB steps) and $-\infty$.
- The left and right channels are controlled independently, allowing a balance function to be implemented.
- Bass: Peaking characteristics bass control with ± 20 dB range in 2 dB steps.
- Treble: Shelving characteristics treble control with ± 10 dB range in 2 dB steps.
- Selector: One of 4 inputs can be selected for both left and right channels.
- Input gain: Input signal amplification from 0 to $+30$ dB (in 2 dB steps)

Features

- Built-in buffer amplifiers reduce the number of external components required.
- Fabricated in a silicon gate CMOS process for minimal switching noise from built-in switches and minimal switching noise even when there is no input signal.
- Built-in zero cross circuits minimize switching noise when input signals are present.
- Built-in $V_{DD}/2$ reference voltage generator circuit.
- All functions are controlled from serial data. Supports the CCB bus.

- CCB is a trademark of SANYO ELECTRIC CO., LTD.
- CCB is SANYO's original bus format and all the bus addresses are controlled by SANYO.

■ Any and all SANYO products described or contained herein do not have specifications that can handle applications that require extremely high levels of reliability, such as life-support systems, aircraft's control systems, or other applications whose failure can be reasonably expected to result in serious physical and/or material damage. Consult with your SANYO representative nearest you before using any SANYO products described or contained herein in such applications.

■ SANYO assumes no responsibility for equipment failures that result from using products at values that exceed, even momentarily, rated values (such as maximum ratings, operating condition ranges, or other parameters) listed in products specifications of any and all SANYO products described or contained herein.

Package Dimensions

unit: mm

3196-DIP30SD

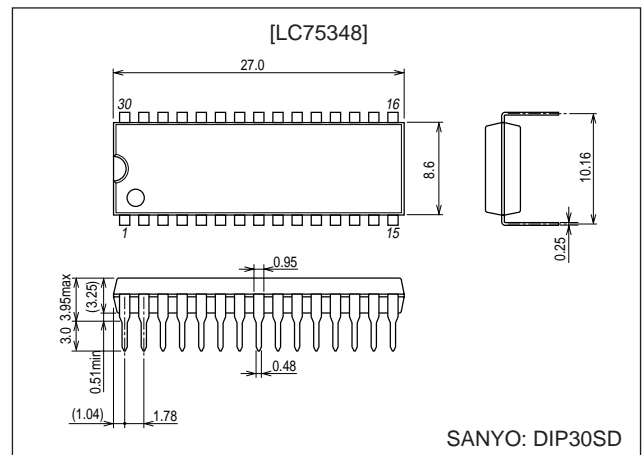

3216-MFP30SD

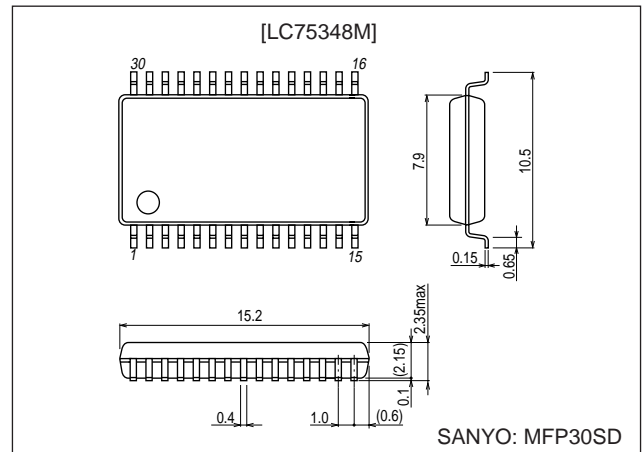

SANYO Electric Co., Ltd. Semiconductor Company

TOKYO OFFICE Tokyo Bldg., 1-10, 1 Chome, Ueno, Taito-ku, TOKYO, 110-8534 JAPAN

LC75348, 75348M

Specifications

Absolute Maximum Ratings at $T_a = 25^\circ\text{C}$, $V_{SS} = 0\text{ V}$

Parameter	Symbol	Conditions	Ratings	Unit	
Maximum supply voltage	$V_{DD\text{ max}}$	V_{DD}	11	V	
Maximum input voltage	$V_{IN\text{ max}}$	All input pins	$V_{SS} - 0.3$ to $V_{DD} + 0.3$	V	
Allowable power dissipation	$P_d\text{ max}$	$T_a \leq 75^\circ\text{C}$, Independent IC	LC75348	450	mW
		$T_a \leq 75^\circ\text{C}$, Mounted on a PCB	LC75348M		
Operating temperature	T_{opr}		-30 to +75	$^\circ\text{C}$	
Storage temperature	T_{stg}		-40 to +125	$^\circ\text{C}$	

Pin Assignment

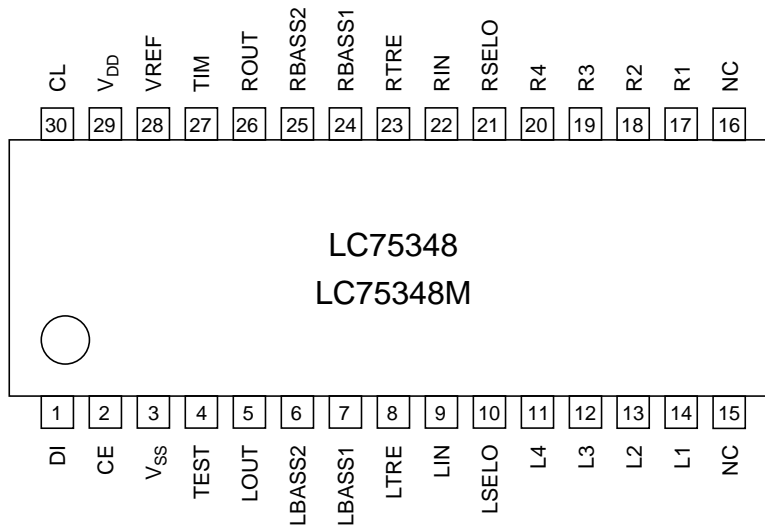

LC75348, 75348M

Allowable Operating Ranges at $T_a = -30$ to $+75^\circ\text{C}$, $V_{SS} = 0$ V

Parameter	Symbol	Conditions	Ratings			Unit
			min	typ	max	
Supply voltage	V_{DD}	V_{DD}	4.5		10	V
High-level input voltage	V_{IH}	CL, DI, CE	2.7		10	V
Low-level input voltage	V_{IL}	CL, DI, CE			1.0	V
Input voltage amplitude	V_{IN}	CE, DI, CL, L1 to L4, R1 to R4, LIN, RIN			V_{DD}	Vp-p
Input pulse width	$t\theta W$	CL	1			μs
Setup time	tsetup	CL, DI, CE	1			μs
Hold time	t _{hold}	CL, DI, CE	1			μs
Operating frequency	f _{opg}	CL			500	kHz

Electrical Characteristics at $T_a = 25^\circ\text{C}$, $V_{DD} = 9$ V, $V_{SS} = 0$ V

Parameter	Symbol	Pin name	Conditions	Ratings			Unit
				min	typ	max	
[Input Block]							
Maximum input gain	G _{in max}				30		dB
Step resolution	G _{step}				2		dB
Input resistance	R _{in}	L1, L2, L3, L4, R1, R2, R3, R4			50		k Ω
Clipping level	V _{cl}	LSELO, RSELO	THD = 1.0%, f = 1 kHz		2.50		V _{rms}
Output load resistance	R _l	LSELO, RSELO		10			k Ω
[Volume Control Block]							
Input resistance	R _{in}	LIN, RIN			50		k Ω
Step resolution	V _{step}				1		dB
[Treble Band Equalizer Control Block]							
Control range	G _{eq}		max. boost/cut	± 8	± 10	± 12	dB
Step resolution	E _{step}			1	2	3	dB
Internal feedback resistance	R _{feed}				51.7		k Ω
[Bass Band Equalizer Control Block]							
Control range	G _{eq}		max. boost/cut	± 18	± 20	± 22	dB
Step resolution	E _{step}			1	2	3	dB
Internal feedback resistance	R _{feed}				66.6		k Ω
[Overall Characteristics]							
Total harmonic distortion	THD		$V_{IN} = 1$ V _{rms} , f = 1 kHz, All controls flat overall			0.01	%
Crosstalk	CT		$V_{IN} = 1$ V _{rms} , f = 1 kHz, R _g = 1 k Ω All controls flat overall	80			dB
Output noise voltage	V _N		All controls flat overall IHF – A		6		μV
Maximum attenuation	V _{omin}		All controls flat overall		-80		dB
Current drain	I _{DD}		$V_{DD} - V_{SS} = +10$ V		40		mA
High-level input current	I _{IH}		CL, DI, CE: $V_{IN} = 10$ V			10	μA
Low-level input current	I _{IL}		CL, DI, CE: $V_{IN} = 0$ V	-10			μA

Equivalent Circuit

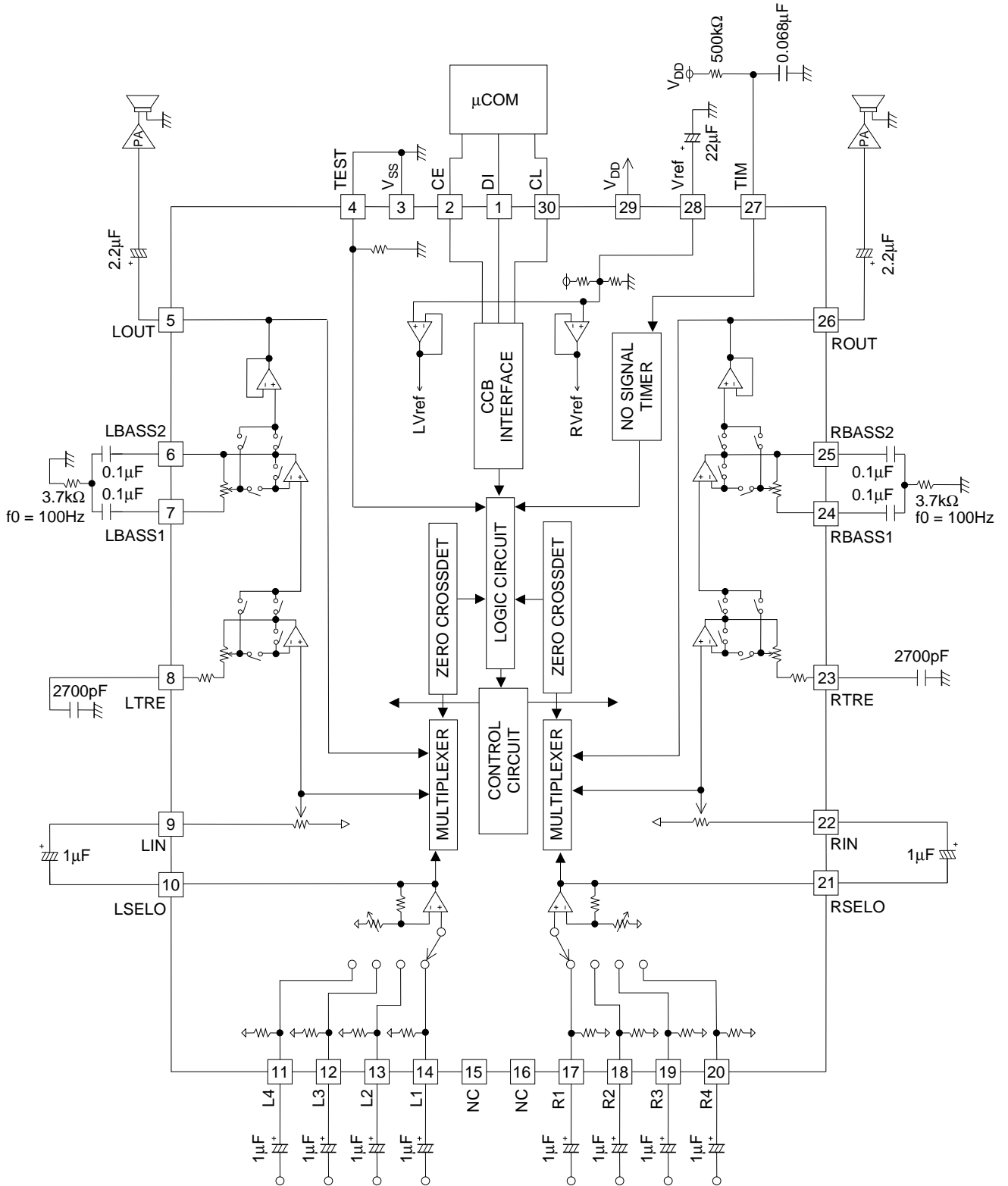

Control System Timing and Data Format

The stipulated serial data must be input to the CL, DI, and CE pins to control the LC75348 and LC75348M. The data structure has a total of 40 bits, of which 8 bits are address and 32 bits are data.

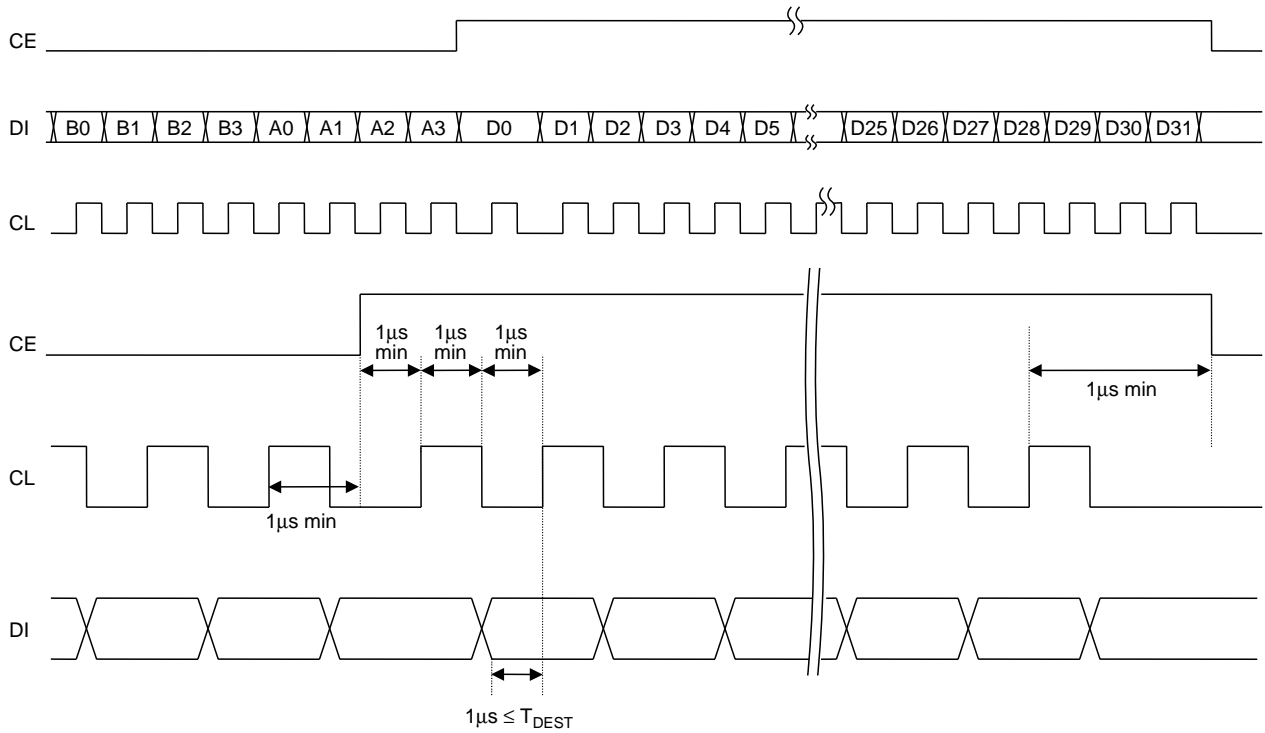

• Address code (B0 to A3)

The data has an 8-bit address code, which allows this IC to be used with the SANYO CCB serial bus.

Address code (LSB)

B0	B1	B2	B3	A0	A1	A2	A3	(82HEX)
0	1	0	0	0	0	0	1	

• Control code allocation

Input switching control
(L1, L2, L3, L4,
R1, R2, R3, R4)

D0	D1	D2	D3	Operation
0	0	0	0	L1 (R1) ON
1	0	0	0	L2 (R2) ON
0	1	0	0	L3 (R3) ON
1	1	0	0	L4 (R4) ON

LC75348, 75348M

Input gain control

D4	D5	D6	D7	Operation
0	0	0	0	0 dB
1	0	0	0	+2 dB
0	1	0	0	+4 dB
1	1	0	0	+6 dB
0	0	1	0	+8 dB
1	0	1	0	+10 dB
0	1	1	0	+12 dB
1	1	1	0	+14 dB
0	0	0	1	+16 dB
1	0	0	1	+18 dB
0	1	0	1	+20 dB
1	1	0	1	+22 dB
0	0	1	1	+24 dB
1	0	1	1	+26 dB
0	1	1	1	+28 dB
1	1	1	1	+30 dB

LC75348, 75348M

Volume control

D8	D9	D10	D11	D12	D13	D14	D15	Operation
0	0	0	0	0	0	0	0	0 dB
1	0	0	0	0	0	0	0	-1 dB
0	1	0	0	0	0	0	0	-2 dB
1	1	0	0	0	0	0	0	-3 dB
0	0	1	0	0	0	0	0	-4 dB
1	0	1	0	0	0	0	0	-5 dB
0	1	1	0	0	0	0	0	-6 dB
1	1	1	0	0	0	0	0	-7 dB
0	0	0	1	0	0	0	0	-8 dB
1	0	0	1	0	0	0	0	-9 dB
0	1	0	1	0	0	0	0	-10 dB
1	1	0	1	0	0	0	0	-11 dB
0	0	1	1	0	0	0	0	-12 dB
1	0	1	1	0	0	0	0	-13 dB
0	1	1	1	0	0	0	0	-14 dB
1	1	1	1	0	0	0	0	-15 dB
0	0	0	0	1	0	0	0	-16 dB
1	0	0	0	1	0	0	0	-17 dB
0	1	0	0	1	0	0	0	-18 dB
1	1	0	0	1	0	0	0	-19 dB
0	0	1	0	1	0	0	0	-20 dB
1	0	1	0	1	0	0	0	-21 dB
0	1	1	0	1	0	0	0	-22 dB
1	1	1	0	1	0	0	0	-23 dB
0	0	0	1	1	0	0	0	-24 dB
1	0	0	1	1	0	0	0	-25 dB
0	1	0	1	1	0	0	0	-26 dB
1	1	0	1	1	0	0	0	-27 dB
0	0	1	1	1	0	0	0	-28 dB
1	0	1	1	1	0	0	0	-29 dB
0	1	1	1	1	0	0	0	-30 dB
1	1	1	1	1	0	0	0	-31 dB
0	0	0	0	0	1	0	0	-32 dB
1	0	0	0	0	1	0	0	-33 dB
0	1	0	0	0	1	0	0	-34 dB
1	1	0	0	0	1	0	0	-35 dB
0	0	1	0	0	1	0	0	-36 dB
1	0	1	0	0	1	0	0	-37 dB
0	1	1	0	0	1	0	0	-38 dB
1	1	1	0	0	1	0	0	-39 dB
0	0	0	1	0	1	0	0	-40 dB
1	0	0	1	0	1	0	0	-41 dB
0	1	0	1	0	1	0	0	-42 dB
1	1	0	1	0	1	0	0	-43 dB
0	0	1	1	0	1	0	0	-44 dB
1	0	1	1	0	1	0	0	-45 dB
0	1	1	1	0	1	0	0	-46 dB
1	1	1	1	0	1	0	0	-47 dB
0	0	0	0	1	1	0	0	-48 dB
1	0	0	0	1	1	0	0	-49 dB
0	1	0	0	1	1	0	0	-50 dB

Continued on next page.

LC75348, 75348M

Continued from preceding page.

D8	D9	D10	D11	D12	D13	D14	D15	Operation
1	1	0	0	1	1	0	0	-51 dB
0	0	1	0	1	1	0	0	-52 dB
1	0	1	0	1	1	0	0	-53 dB
0	1	1	0	1	1	0	0	-54 dB
1	1	1	0	1	1	0	0	-55 dB
0	0	0	1	1	1	0	0	-56 dB
1	0	0	1	1	1	0	0	-57 dB
0	1	0	1	1	1	0	0	-58 dB
1	1	0	1	1	1	0	0	-59 dB
0	0	1	1	1	1	0	0	-60 dB
1	0	1	1	1	1	0	0	-61 dB
0	1	1	1	1	1	0	0	-62 dB
1	1	1	1	1	1	0	0	-63 dB
0	0	0	0	0	0	1	0	-64 dB
1	0	0	0	0	0	1	0	-65 dB
0	1	0	0	0	0	1	0	-66 dB
1	1	0	0	0	0	1	0	-67 dB
0	0	1	0	0	0	1	0	-68 dB
1	0	1	0	0	0	1	0	-69 dB
0	1	1	0	0	0	1	0	-70 dB
1	1	1	0	0	0	1	0	-71 dB
0	0	0	1	0	0	1	0	-72 dB
1	0	0	1	0	0	1	0	-73 dB
0	1	0	1	0	0	1	0	-74 dB
1	1	0	1	0	0	1	0	-75 dB
0	0	1	1	0	0	1	0	-76 dB
1	0	1	1	0	0	1	0	-77 dB
0	1	1	1	0	0	1	0	-78 dB
1	1	1	1	0	0	1	0	-79 dB
0	0	0	0	1	0	1	0	-∞

Treble control

D16	D17	D18	D19	Operation
1	0	1	0	+10 dB
0	0	1	0	+8 dB
1	1	0	0	+6 dB
0	1	0	0	+4 dB
1	0	0	0	+2 dB
0	0	0	0	0 dB
1	0	0	1	-2 dB
0	1	0	1	-4 dB
1	1	0	1	-6 dB
0	0	1	1	-8 dB
1	0	1	1	-10 dB

LC75348, 75348M

Bass control

D20	D21	D22	D23	D24	Operation
0	1	0	1	0	+20 dB
1	0	0	1	0	+18 dB
0	0	0	1	0	+16 dB
1	1	1	0	0	+14 dB
0	1	1	0	0	+12 dB
1	0	1	0	0	+10 dB
0	0	1	0	0	+8 dB
1	1	0	0	0	+6 dB
0	1	0	0	0	+4 dB
1	0	0	0	0	+2 dB
0	0	0	0	0	0 dB
1	0	0	0	1	-2 dB
0	1	0	0	1	-4 dB
1	1	0	0	1	-6 dB
0	0	1	0	1	-8 dB
1	0	1	0	1	-10 dB
0	1	1	0	1	-12 dB
1	1	1	0	1	-14 dB
0	0	0	1	1	-16 dB
1	0	0	1	1	-18 dB
0	1	0	1	1	-20 dB

Zero cross control

D25	Operation
0	Data is written according to zero cross detection.
1	Zero cross detection operation is stopped. (Data is acquired on the falling edge of the CE signal.)

Channel selection

D26	D27	Operation
0	0	
1	0	RCH
0	1	LCH
1	1	Left and right channels at the same time

Zero cross signal detection block control

D28	D29	Operation
0	0	Selector
1	0	Volume
0	1	Tone

Test mode

D30	D31	Operation
0	0	
These bits select the IC test modes and must be set to 0 during normal operation.		

Pin Functions

Pin No.	Pin	Function	Notes
14 13 12 11 17 18 19 20	L1 L2 L3 L4 R1 R2 R3 R4	• Audio signal inputs	
10 21	LSELO RSELO	• Input selector outputs	
7 6 24 25	LBASS1 LBASS2 RBASS1 RBASS2	• Connections for the capacitors and resistors that form the bass band filters	
9 22	LIN RIN	• Volume and equalizer inputs	
5 26	LOUT ROUT	• Volume and equalizer outputs	
8 23	LTRE RTRE	• Connections for the capacitors that form the treble band filters	

Continued on next page.

LC75348, 75348M

Continued from preceding page.

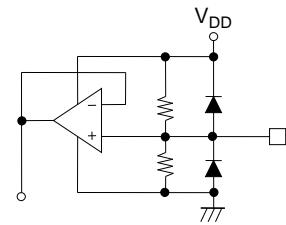
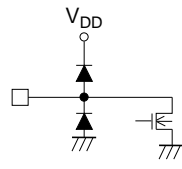
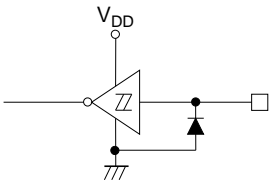
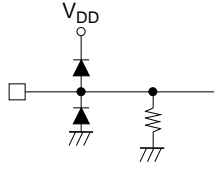
Pin No.	Pin	Function	Notes
28	Vref	<ul style="list-style-type: none"> • 1/2 V_{DD} voltage generator used for the analog system ground • A capacitor of about 10 μF must be connected between Vref and AV_{SS} (V_{SS}) to minimize power supply ripple. 	
3	V_{SS}	<ul style="list-style-type: none"> • Ground 	
29	V_{DD}	<ul style="list-style-type: none"> • Power supply 	
27	TIM	<ul style="list-style-type: none"> • Time setting for the zero cross circuit no signal state time. • If no zero cross is recognized between the time the data is stored and the time this timer completes, the data is acquired forcibly. 	
2	CE	<ul style="list-style-type: none"> • Chip enable • Data is written to the internal latch and the analog switches operate when this pin goes from high to low. Data transfers are enabled when this pin is high. 	
1 30	DI CL	<ul style="list-style-type: none"> • Inputs for the clock and serial data signals used to control this IC 	
4	TEST	<ul style="list-style-type: none"> • Electronic volume control test pin. • This pin must be tied to the V_{SS} level. 	
15 16	NC	<ul style="list-style-type: none"> • Unused (no connection) pins. These pins must be either left open or tied to V_{SS}. 	

Internal Equivalent Circuits

- Selector Block Equivalent Circuit

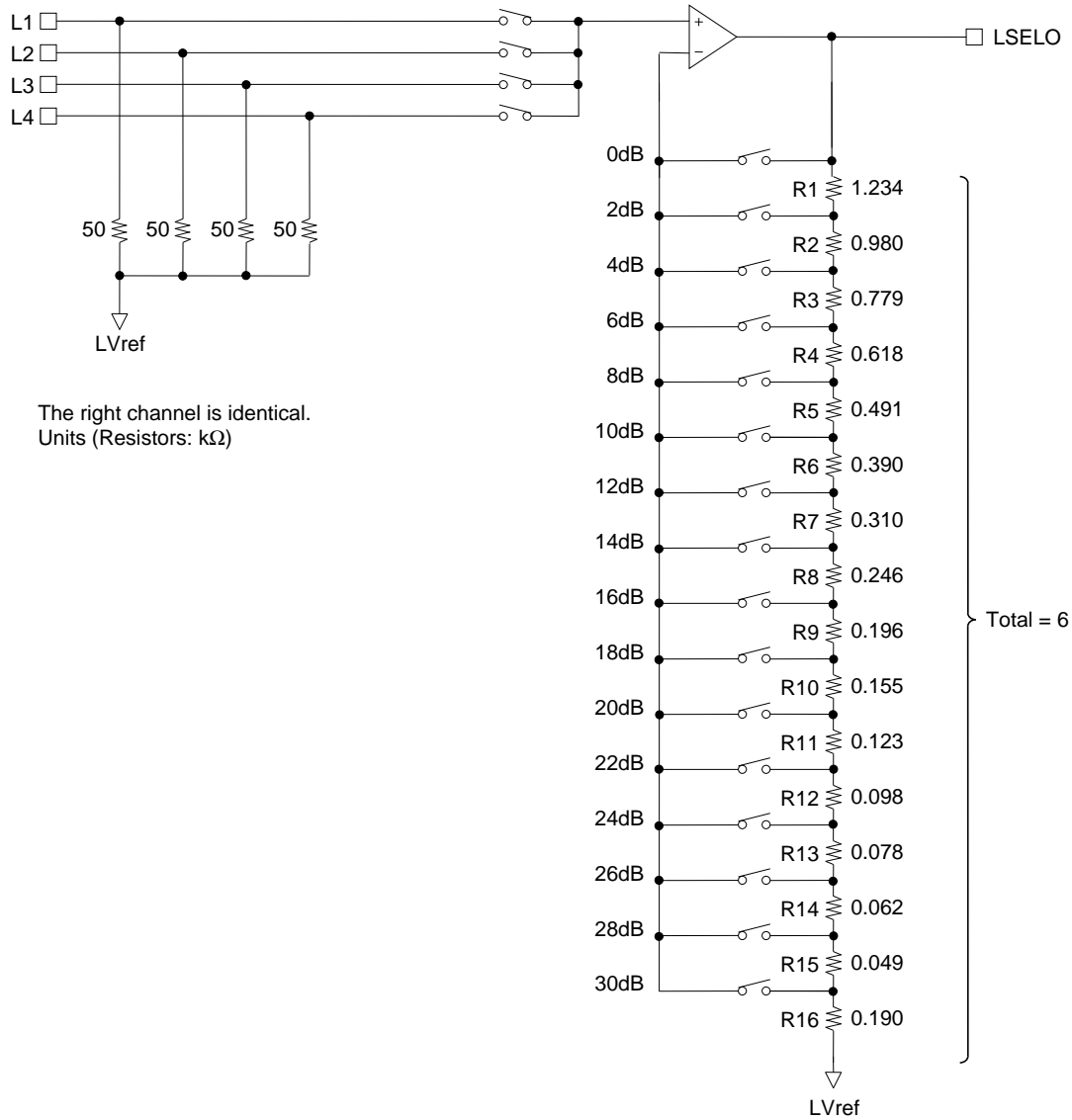

LC75348, 75348M

• Volume Control Block Internal Equivalent Circuit

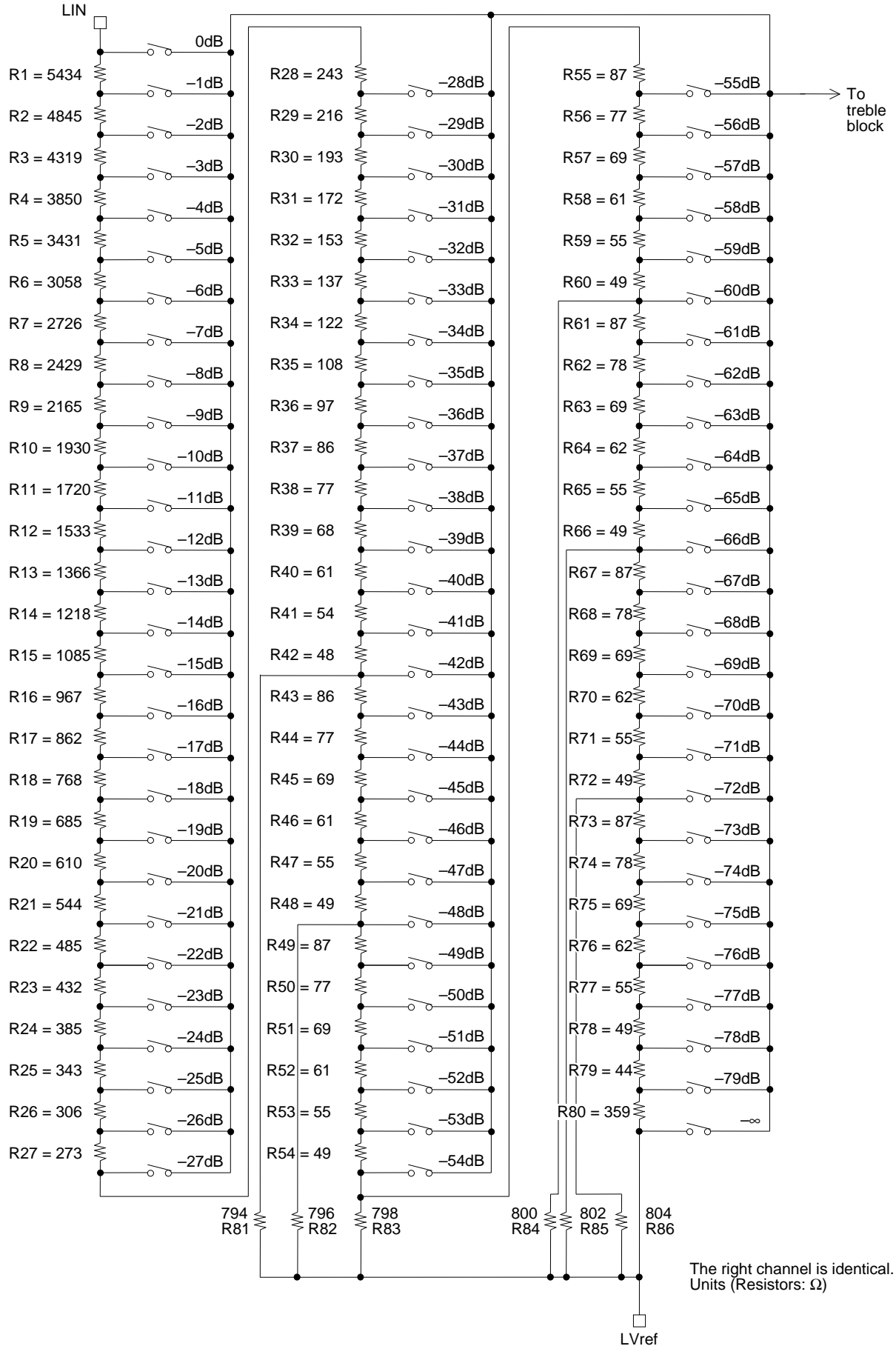

• Treble/Bass Band Block Internal Equivalent Circuit

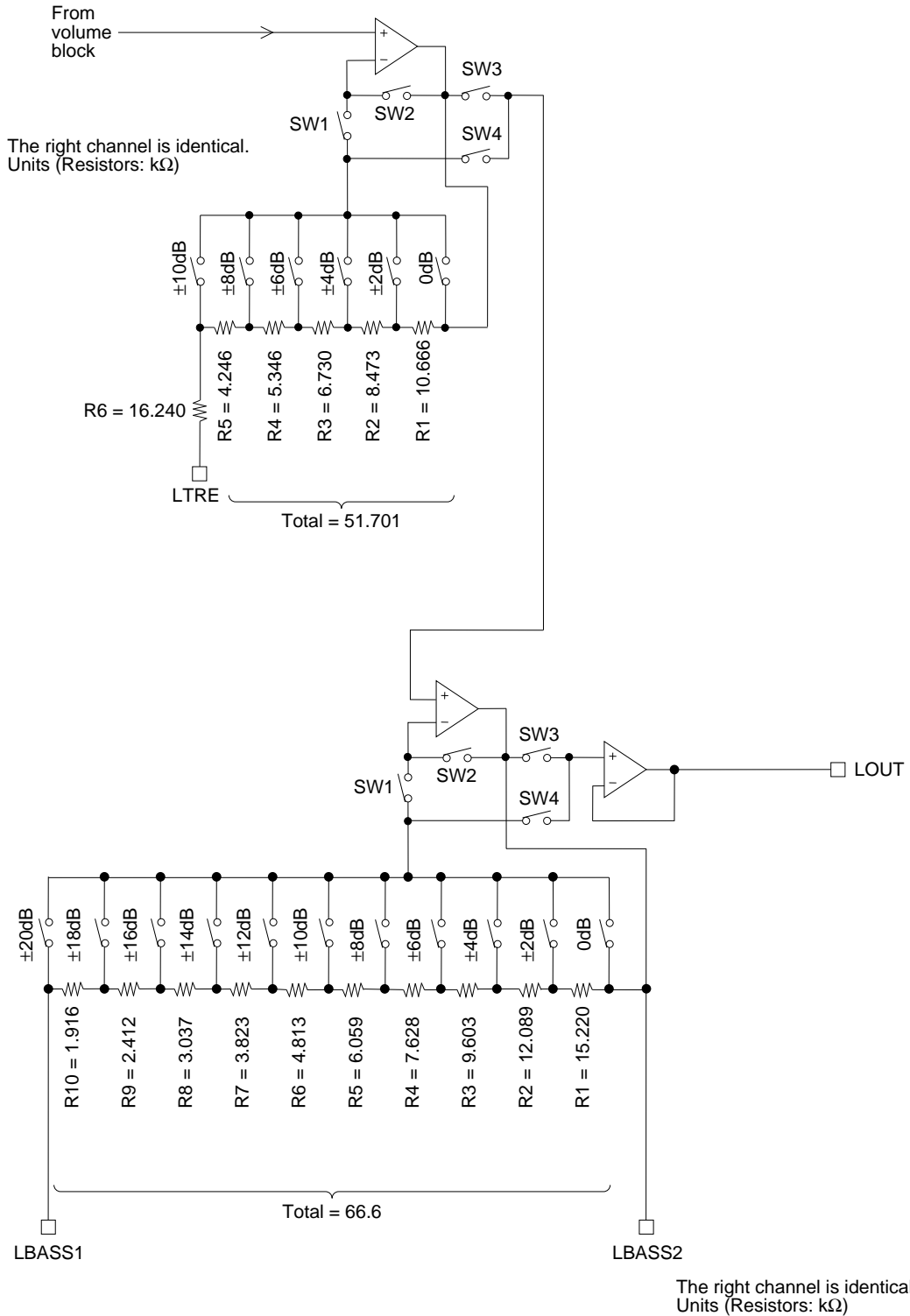

For boost, switches SW1 and SW3 are on, and for cut, switches SW2 and SW4 are on.
For 0 dB, the 0dB SW, SW2, and SW3 are on.

Bass Band Circuit

This section presents the equivalent circuit and the formulas for calculating the R and C values for a 100 Hz center frequency.

- Bass band equivalent circuit

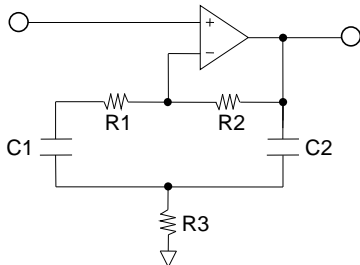

- Sample calculation

Specifications: Center frequency: $f_0 = 100$ Hz

Gain at maximum boost: $G = 20$ dB

Assume $R_1 = 0$, $R_2 = 66.6$ k Ω , and $C_1 = C_2 = C$.

- (1) Determine R_3 from the $G = 20$ dB condition.

$$G_{+20dB} = 20 \times \text{LOG}_{10} \left(1 + \frac{R_2}{2R_3} \right)$$

$$R_3 = \frac{R_2}{2(10^{G+20dB/20} - 1)} = \frac{66000}{2 \times (10 - 1)} \cong 3.7\text{k}\Omega$$

- (2) Determine C from the center frequency $f_0 = 100$ Hz condition

$$f_0 = \frac{1}{2\pi\sqrt{R_3R_2C_1C_2}}$$

$$C = \frac{1}{2\pi f_0 \sqrt{R_3R_2}} = \frac{1}{2\pi \times 100 \sqrt{66000 \times 3700}} \cong 0.1\mu F$$

- (3) Determine Q

$$Q = \frac{R_3R_2}{2R_3} \cdot \frac{1}{\sqrt{R_3R_2}} \cong 2.1$$

Treble Band Circuit

The treble band circuit can provide shelving characteristics.

This section presents the equivalent circuit for boost operation and the calculation formulas.

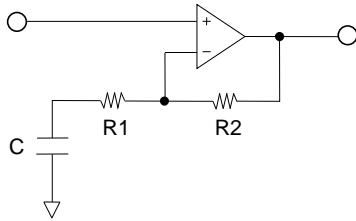

- Sample calculation

Specifications: Set frequency: $f = 26,000$ Hz

Gain at maximum boost: $G_{+10 \text{ dB}} = 10$ dB

Assume $R1 = 16.240$ K Ω , and $R2 = 35.461$ K Ω .

The constants mentioned above are calculated as follows.

$$G = 20 \times \text{LOG}_{10} \left(1 + \frac{R2}{\sqrt{R1^2 + (1 / \omega C)^2}} \right)$$

$$C = \frac{1}{2\pi f \sqrt{\left(\frac{R2}{10^{G/20} - 1} \right)^2 - R1^2}}$$

$$= \frac{1}{2\pi 26000 \sqrt{\left(\frac{35461}{3.16 - 1} \right)^2 - 16240^2}} \cong 2700(\text{pF})$$

Usage Notes

- The internal transistor states are undefined when power is first applied. Applications must mute the output until control data has been written to the IC.
- Operational description of the zero cross switching circuit

The LC75348 and LC75348M provide a function that can switch the zero cross comparator signal detection point, allowing applications to select an optimal detection point for the block whose data is being updated. Basically, switching noise can be minimized if the signal immediately following the block whose data is updated is input to the zero cross comparator. This means that the detection point must be switched each time data is updated.

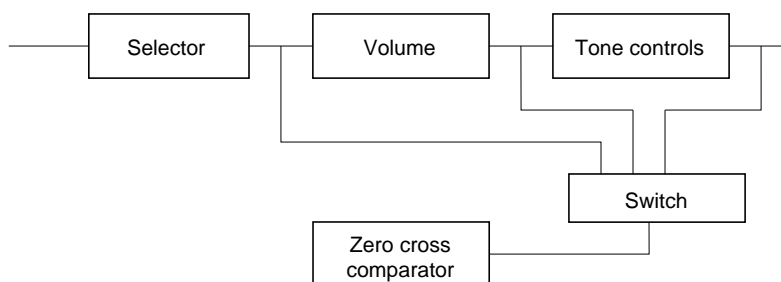

LC75348 and LC75348M Zero Cross Detection Circuit

- Zero cross switching control procedure

The zero cross switching control procedure consists of three steps. First, set the zero cross control bit to zero cross detection mode (D25 = 0), then specify the block for detection (with bits D28 and D29), and finally transfer the data. Since these control bits are latched first, immediately after the data is transferred, i.e. on the CE falling edge, the mode can be set in a single data transfer operation when updating the volume control or other control block data. The figure below presents an example of the control used when updating the volume control block data.

D25	D28	D29
0	1	0

Zero cross detection mode setting Volume control block setting

• Zero cross timer setting

If the input signal is lower than the zero cross comparator detection sensitivity, or if a low-frequency signal is input, the state in which the circuit cannot detect a zero cross may continue and the input data will not be latched during that period.

The zero cross timer sets a time for the data to be latched forcibly in states such as this where a zero cross cannot be detected.

For example, to set a 25 ms time:

$$T = 0.69 CR$$

Assume $C = 0.068 \mu\text{F}$. The R will be:

$$R = \frac{25 \times 10^{-3}}{0.69 \times 0.068 \times 10^{-6}} \approx 530 \text{ k}\Omega$$

Normally, a time in the range 10 to 50 ms is used.

• Notes on serial data transfer

(1) Cover the CL, DI, and CE signal lines with the ground pattern or use shielded lines to prevent the high-frequency digital signals carried by these lines from entering the analog signal system.

(2) The LC75348 and LC75348M data format consists of 8 bits of address and 32 bits of data. When transmitting data as an even multiple of 8 bits (when transferring 36 bits of data), use the data format shown below.

LC75348 and LC75348M Data Reception in Multiples of 8 Bits

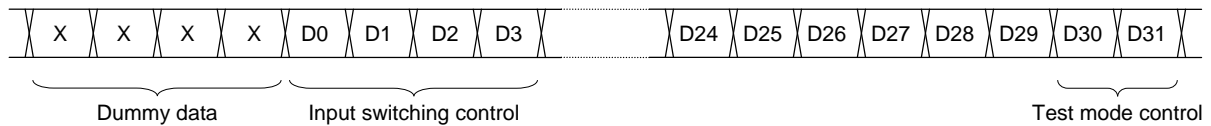

X: don't care

Input Gain Characteristics

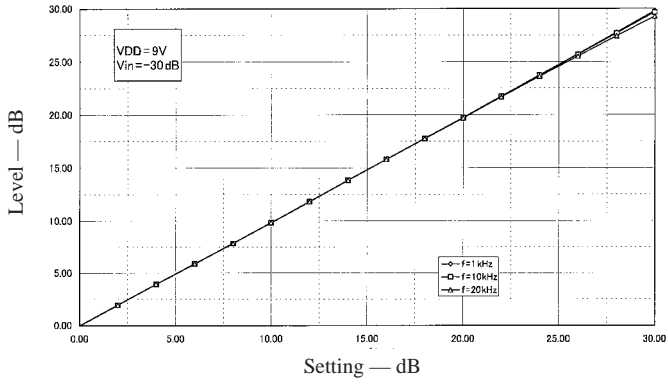

Volume Characteristics

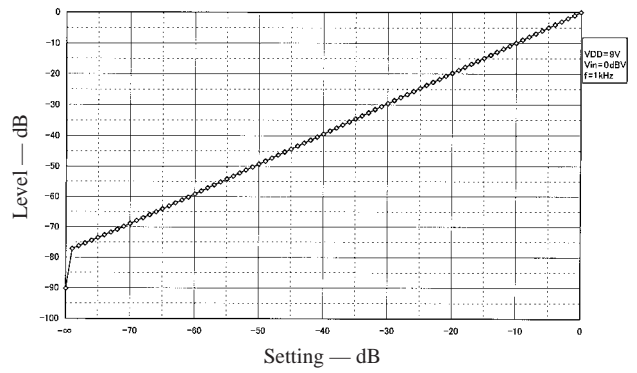

Bass Characteristics

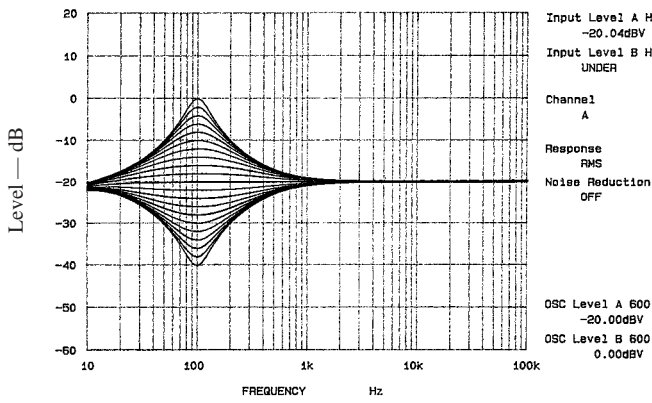

Treble Characteristics

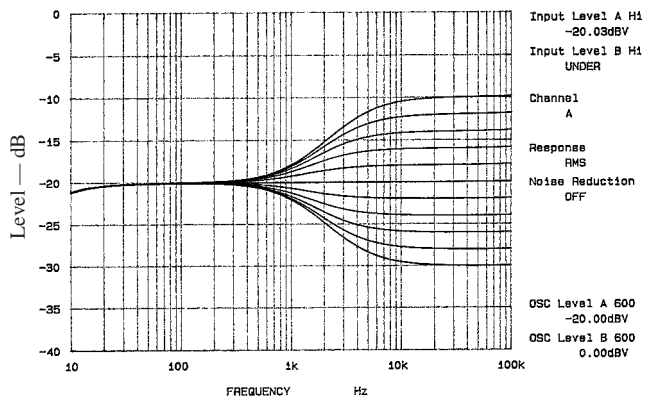

THD – Frequency Characteristics

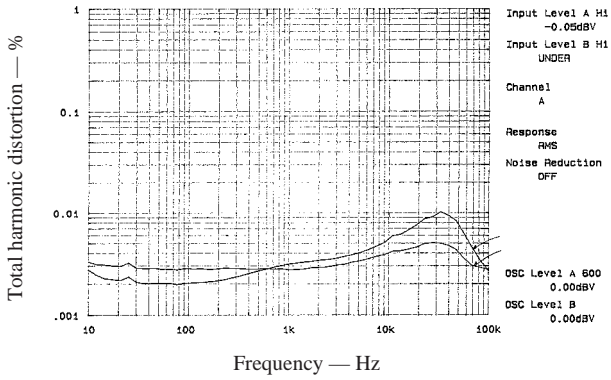

THD – Input Level Characteristics

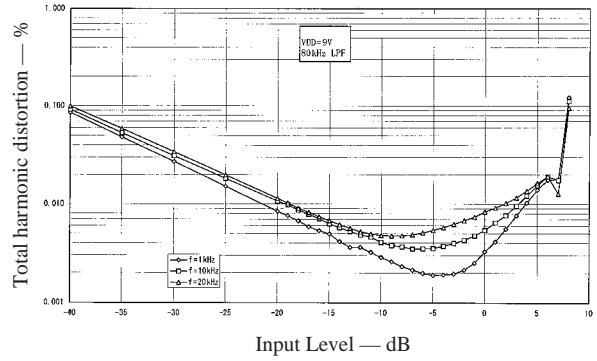

THD – Supply Voltage Characteristics

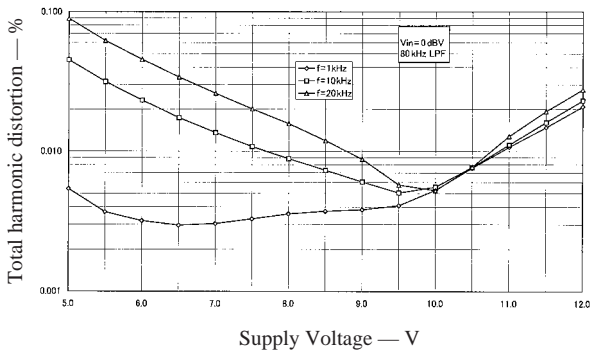

- Specifications of any and all SANYO products described or contained herein stipulate the performance, characteristics, and functions of the described products in the independent state, and are not guarantees of the performance, characteristics, and functions of the described products as mounted in the customer's products or equipment. To verify symptoms and states that cannot be evaluated in an independent device, the customer should always evaluate and test devices mounted in the customer's products or equipment.
- SANYO Electric Co., Ltd. strives to supply high-quality high-reliability products. However, any and all semiconductor products fail with some probability. It is possible that these probabilistic failures could give rise to accidents or events that could endanger human lives, that could give rise to smoke or fire, or that could cause damage to other property. When designing equipment, adopt safety measures so that these kinds of accidents or events cannot occur. Such measures include but are not limited to protective circuits and error prevention circuits for safe design, redundant design, and structural design.
- In the event that any or all SANYO products (including technical data, services) described or contained herein are controlled under any of applicable local export control laws and regulations, such products must not be exported without obtaining the export license from the authorities concerned in accordance with the above law.
- No part of this publication may be reproduced or transmitted in any form or by any means, electronic or mechanical, including photocopying and recording, or any information storage or retrieval system, or otherwise, without the prior written permission of SANYO Electric Co., Ltd.
- Any and all information described or contained herein are subject to change without notice due to product/technology improvement, etc. When designing equipment, refer to the "Delivery Specification" for the SANYO product that you intend to use.
- Information (including circuit diagrams and circuit parameters) herein is for example only; it is not guaranteed for volume production. SANYO believes information herein is accurate and reliable, but no guarantees are made or implied regarding its use or any infringements of intellectual property rights or other rights of third parties.

This catalog provides information as of January, 2003. Specifications and information herein are subject to change without notice.