

Optical Image Stabilization (OIS) Controller & Driver

CMOS LSI

LC898121XA



WLCSP40, 2.44 x 3.94
CASE 567JB

Overview

The LC898121XA is a system LSI integrating a digital signal processing function for Optical Image Stabilization (OIS) and a saturation-driven H bridge driver function.

Features

Digital Signal Processing

- Built-in Digital Servo Circuit
- Built-in Gyro Filter
- AD Converter
 - ◆ 12 Bit
 - ◆ Input 3ch
 - ◆ Equipped with a Sample-hold Circuit
- DA Converter
 - ◆ 8 Bit
 - ◆ Output 2ch
- Built-in Serial I/F Circuit (4-wire SPI or 2-wire I²C-Bus Interface)
- Built-in Hall Bias Circuit
- Built-in Hall Amp
- Built-in OSC (Oscillator)
 - ◆ Typ. 48 MHz
- Built-in LDO (Low Drop-Out Regulator)
 - ◆ Generation Logic Power (Typ 1.8 V)
- Digital Gyro I/F for the Companies (Please Refer for the Details)

Motor Driver

- Saturation-drive H Bridge x2ch
- I_O max: 300 mA

Package

- WLCSP40, 2.44 mm x 3.94 mm, Thickness Max 0.65 mm
- This is a Pb-Free and Halogen Free Device

Power Supply Voltage

- DA/VGA: DAOPVDD = 2.6 V to 3.6 V
- AD: ADVDD = 2.6 V to 3.6 V
- IO/OSC/LDO: DVDD30 = 2.6 V to 3.6 V
- Driver: VM = 2.6 V to 5.5 V
- Core Logic: Use built-in LDO/External VDD: DVDD18 = 1.8 V ±10%

MARKING DIAGRAM

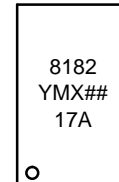

8121 = Specific Device Code
Y = Year
M = Month
X = Assembly Location
= Conversion Character Representing Assembly Lot

ORDERING INFORMATION

Device	Package	Shipping†
LC898121XA-MH	WLCSP40, 2.44 x 3.94 (Pb-Free / Halogen Free)	4000 / Tape & Reel

†For information on tape and reel specifications, including part orientation and tape sizes, please refer to our Tape and Reel Packaging Specification Brochure, BRD8011/D.

LC898121XA

BLOCK DIAGRAM

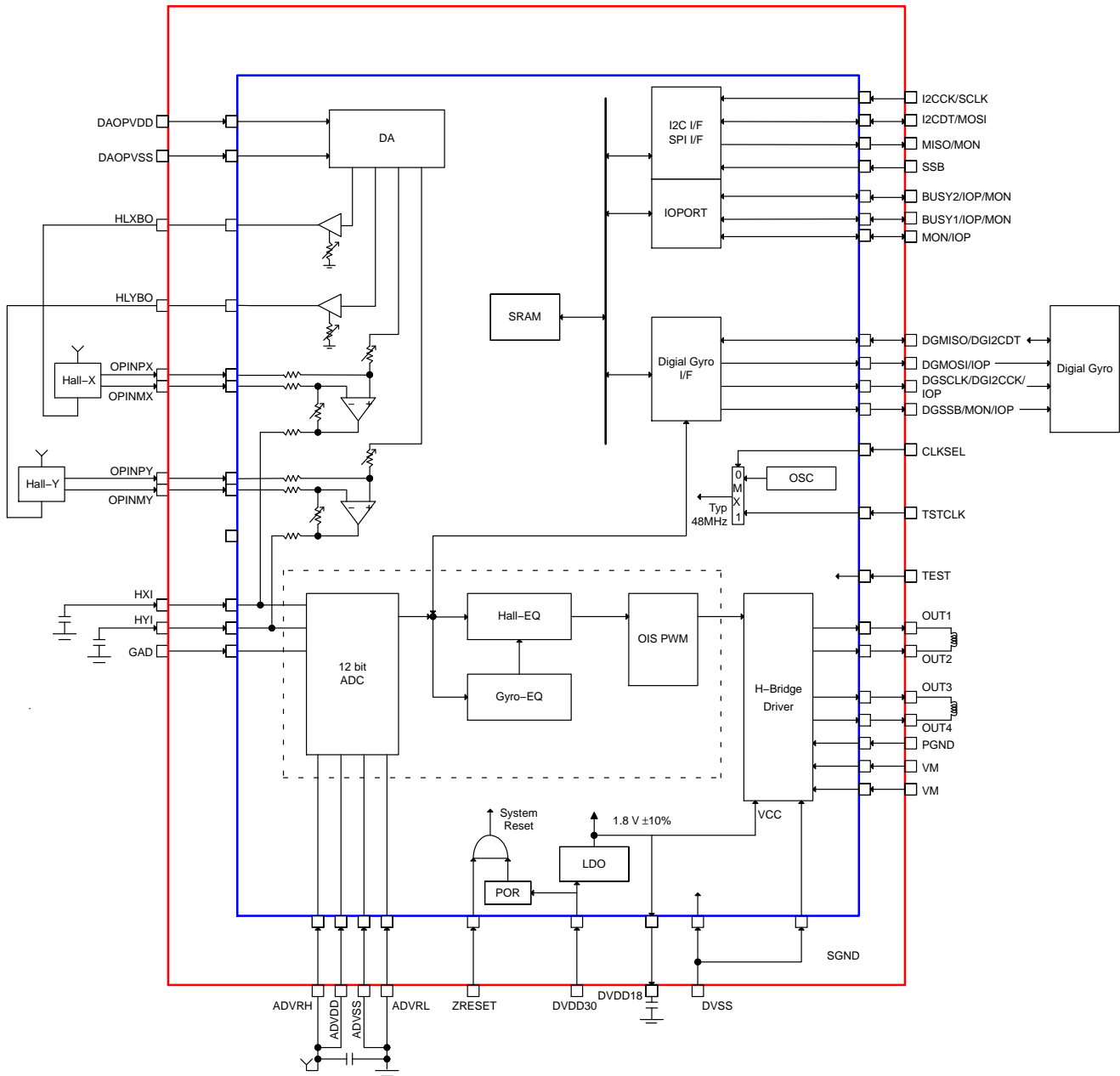

Figure 1. Example of Wiring Diagram [Hall] in LC898121XA (WLP40)

LC898121XA

PIN ASSIGNMENT

	E	D	C	B	A
8	OPINPX	OPINMY	ADVDD	ADVSS	HXI
7	OPINMX	OPINPY	ADVRH	ADVRL	HYI
6	HLXBO	HLYBO	DAOPVDD	DAOPVSS	I2CCK
5	DGSKLK	DGMOSI	GAD	MISO	I2CDT
4	DGMISO	DGSSB	MON	SSB	DVDD18
3	DVSS	CLKSEL	TSTCLK	TEST	DVDD30
2	VM	BUSY2	BUSY1	ZRESET	VM
1	OUT4	OUT3	PGND	OUT2	OUT1

	Driver		Digital GND
	AD 3 V		Digital 3 V VDD
	VGA & DAC 3 V		Logic Core 1.8 V VDD (Output)

Figure 2. WLP40 Bottom View

LC898121XA

PIN DESCRIPTION (Type – I: INPUT, O: OUTPUT, B: BIDIRECTION, P: Power)

Ball No	Pin Name	Type	Description
A1	OUT1	O	Driver Output
A2	VM	P	Driver VDD (2.6 V to 5.5 V)
A3	DVDD30	P	Logic 3 V VDD (2.6 V to 3.6 V)
A4	DVDD18	P	LDO Power supply out (Logic Core VDD (typ 1.8 V))
A5	I2CDT	B	I2C_IF data (B) / SPI IF data (I)
A6	I2CCK	I	I2C_IF clock / SPI IF clock
A7	HYI	I	Hall-Y AD input
A8	HXI	I	Hall-X AD input
B1	OUT2	O	Driver output
B2	ZRESET	I	HardWafer Reset
B3	TEST	I	SPI & External clock case sets [1]. other cases set [0]
B4	SSB	B	SPI I/F Chip Select (I) / General-purpose IOPORT(B) / inner signal monitor (O)
B5	MISO	B	SPI I/F data (O) / inner signal monitor / General-purpose IOPORT
B6	DAOPVSS	P	DA&OpAmp VSS
B7	ADVRL	I	ADC ReferenceVoltage Low input
B8	ADVSS	I	AD GND
C1	PGND	P	Driver GND
C2	BUSY1	B	BUSY1 (O) / General-purpose IOPORT (B) / inner signal monitor (O)
C3	TSTCLK	I	CLKSEL = 1: External Clock, CLKSEL = 0: change pin of I ² C (0) and SPI (1)
C4	MON	B	inner signal monitor / general-purpose IOPORT
C5	GAD	I	General AD input
C6	DAOPVDD	P	DA&OpAmp VDD (2.6 V to 3.6 V)
C7	ADVRH	I	ADC ReferenceVoltage High input
C8	ADVDD	P	AD VDD (2.6 V to 3.6 V)
D1	OUT3	O	Driver output
D2	BUSY2	B	BUSY2 (O) / General-purpose IOPORT (B) / inner signal monitor (O)
D3	CLKSEL	I	change pin of OSC (0) and External clock (1)
D4	DGSSB	B	Digital Gyro SPI IF Chip Select (O) / inner signal monitor (O) / General-purpose IOPORT (B)
D5	DGMOSI	B	Digital Gyro (4-wire) IF data (O) / General-purpose IOPORT (B)
D6	HLXBO	O	Hall-Y Bias (Current drive)
D7	OPINPY	I	Hall-Y OpAmp input+
D8	OPINMY	I	Hall-Y OpAmp input-
E1	OUT4	O	Driver output
E2	VM	P	Driver VDD (2.6 V to 5.5 V)
E3	DVSS	P	Logic GND
E4	DGMISO	B	Digital Gyro SPI IF data (I) / Digital Gyro I ² C IF data (B)
E5	DGSCLK	B	Digital Gyro SPI IF clock (O) / Digital Gyro I ² C IF clock (O) / General purpose IOPORT (B)
E6	HLXBO	O	Hall-Y Bias (Current drive)
E7	OPINMX	I	Hall-X OpAmp input-
E8	OPINPX	I	Hall-X OpAmp input+

onsemi is licensed by the Philips Corporation to carry the I²C bus protocol

MECHANICAL CASE OUTLINE

PACKAGE DIMENSIONS

ON Semiconductor®

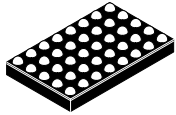

SCALE 4:1

WLCSP40, 2.44x3.94
CASE 567JB
ISSUE O

DATE 27 AUG 2013

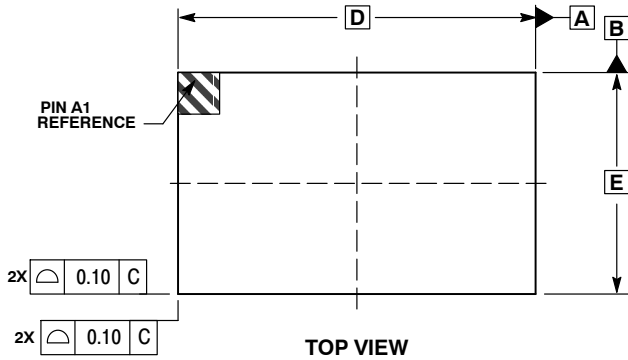

NOTES:

1. DIMENSIONING AND TOLERANCING PER ASME Y14.5M, 1994.
2. CONTROLLING DIMENSION: MILLIMETERS.
3. COPLANARITY APPLIES TO SPHERICAL CROWNS OF SOLDER BALLS.

DIM	MILLIMETERS	
	MIN	MAX
A	---	0.65
A1	0.15	0.24
b	0.22	0.32
D	2.44 BSC	
E	3.94 BSC	
e	0.50 BSC	

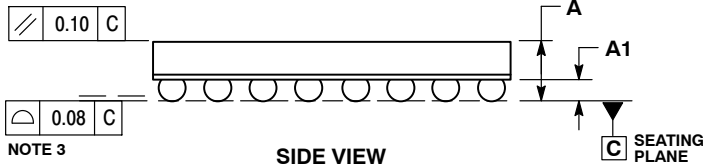

RECOMMENDED SOLDERING FOOTPRINT*

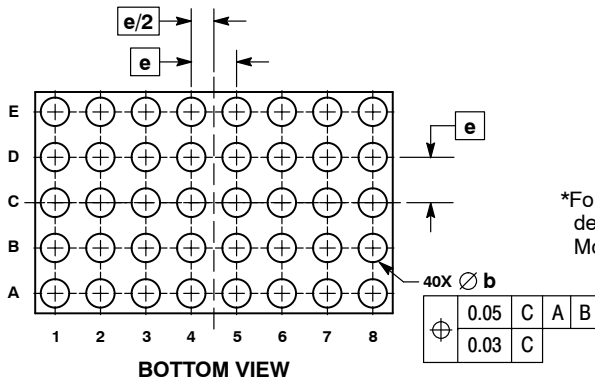
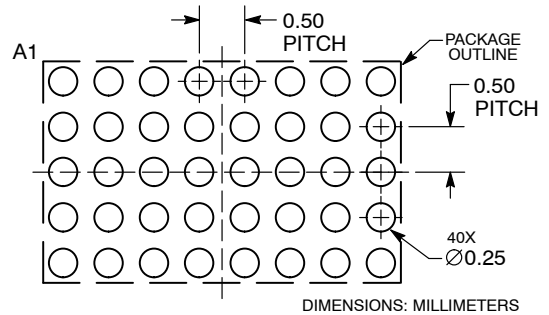

*For additional information on our Pb-Free strategy and soldering details, please download the ON Semiconductor Soldering and Mounting Techniques Reference Manual, SOLDERRM/D.

DOCUMENT NUMBER:	98AON77763F	Electronic versions are uncontrolled except when accessed directly from the Document Repository. Printed versions are uncontrolled except when stamped "CONTROLLED COPY" in red.
DESCRIPTION:	WLCSP40, 2.44X3.94	PAGE 1 OF 1

ON Semiconductor and are trademarks of Semiconductor Components Industries, LLC dba ON Semiconductor or its subsidiaries in the United States and/or other countries. ON Semiconductor reserves the right to make changes without further notice to any products herein. ON Semiconductor makes no warranty, representation or guarantee regarding the suitability of its products for any particular purpose, nor does ON Semiconductor assume any liability arising out of the application or use of any product or circuit, and specifically disclaims any and all liability, including without limitation special, consequential or incidental damages. ON Semiconductor does not convey any license under its patent rights nor the rights of others.

onsemi, **Onsemi**, and other names, marks, and brands are registered and/or common law trademarks of Semiconductor Components Industries, LLC dba "**onsemi**" or its affiliates and/or subsidiaries in the United States and/or other countries. **onsemi** owns the rights to a number of patents, trademarks, copyrights, trade secrets, and other intellectual property. A listing of **onsemi**'s product/patent coverage may be accessed at www.onsemi.com/site/pdf/Patent-Marking.pdf. **onsemi** reserves the right to make changes at any time to any products or information herein, without notice. The information herein is provided "as-is" and **onsemi** makes no warranty, representation or guarantee regarding the accuracy of the information, product features, availability, functionality, or suitability of its products for any particular purpose, nor does **onsemi** assume any liability arising out of the application or use of any product or circuit, and specifically disclaims any and all liability, including without limitation special, consequential or incidental damages. Buyer is responsible for its products and applications using **onsemi** products, including compliance with all laws, regulations and safety requirements or standards, regardless of any support or applications information provided by **onsemi**. "Typical" parameters which may be provided in **onsemi** data sheets and/or specifications can and do vary in different applications and actual performance may vary over time. All operating parameters, including "Typicals" must be validated for each customer application by customer's technical experts. **onsemi** does not convey any license under any of its intellectual property rights nor the rights of others. **onsemi** products are not designed, intended, or authorized for use as a critical component in life support systems or any FDA Class 3 medical devices or medical devices with a same or similar classification in a foreign jurisdiction or any devices intended for implantation in the human body. Should Buyer purchase or use **onsemi** products for any such unintended or unauthorized application, Buyer shall indemnify and hold **onsemi** and its officers, employees, subsidiaries, affiliates, and distributors harmless against all claims, costs, damages, and expenses, and reasonable attorney fees arising out of, directly or indirectly, any claim of personal injury or death associated with such unintended or unauthorized use, even if such claim alleges that **onsemi** was negligent regarding the design or manufacture of the part. **onsemi** is an Equal Opportunity/Affirmative Action Employer. This literature is subject to all applicable copyright laws and is not for resale in any manner.

PUBLICATION ORDERING INFORMATION

LITERATURE FULFILLMENT:

Email Requests to: orderlit@onsemi.com

onsemi Website: www.onsemi.com

TECHNICAL SUPPORT

North American Technical Support:

Voice Mail: 1 800-282-9855 Toll Free USA/Canada

Phone: 011 421 33 790 2910

Europe, Middle East and Africa Technical Support:

Phone: 00421 33 790 2910

For additional information, please contact your local Sales Representative