

■ Features

- Colorless transparency lens type
- $\phi 5\text{mm}$ (T-1 $\frac{3}{4}$) all plastic mold type
- High luminosity
- ESD Class(Mil Std-883d Method 3015.7) based on Human Body Model(HBM) : Class 3

■ Outline dimensions

(unit : mm)

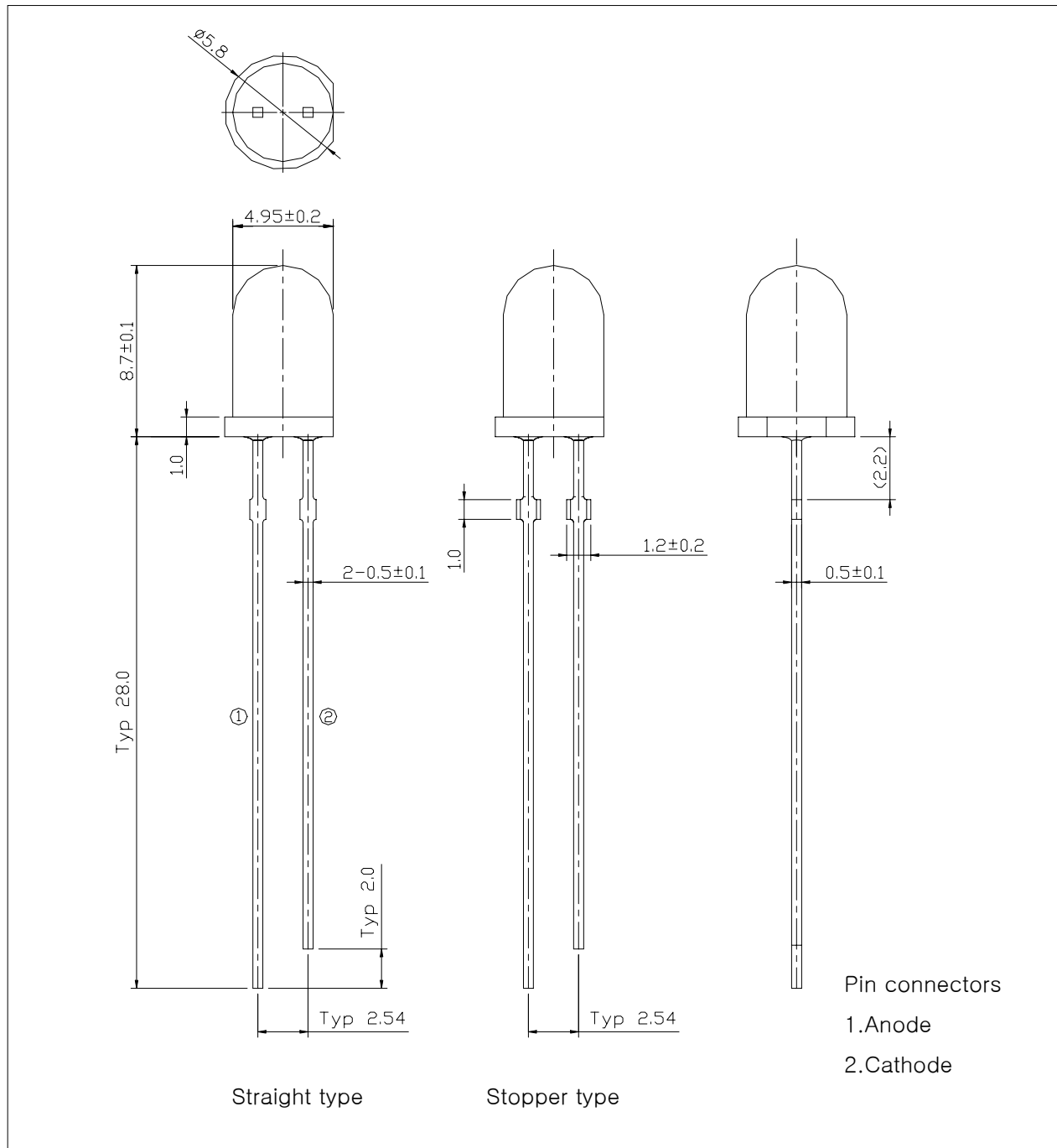

■ Absolute maximum ratings

Characteristic	Symbol	Ratings	Unit
Power dissipation	P_D	120	mW
Forward Current	I_F	30	mA
* ¹ Peak Forward Current	I_{FP}	100	mA
Reverse Voltage	V_R	5	V
Operating Temperature	T_{opr}	-30~85	°C
Storage Temperature	T_{stg}	-40~100	°C
* ² Soldering Temperature	T_{sol}	260°C for 3 seconds	

*1.Duty ratio 1/10, Pulse Width 10msec

*2.Keep the distance more than 2.0mm from PCB to the bottom of LED package

■ Electrical – Optical characteristics

(Ta=25°C)

Characteristic	Symbol	Test Condition	Min.	Typ.	Max.	Unit
ESD Check Forward Voltage	V_{F2}	$I_F=10\mu A$	2.0	-	-	V
Reverse Current	I_R	$V_R=5V$	-	-	50	uA
Dominant Wavelength	λ_d	$I_F=20mA$	500	-	510	nm
Spectrum Bandwidth	$\Delta\lambda$	$I_F=20mA$	-	35	-	nm
* ³ Half Angle	$\theta_{1/2}$	$I_F=20mA$	-	±17	-	deg

*3. $\theta_{1/2}$ is the off-axis angle where the luminous intensity is 1/2 the peak intensity

■ Dominant Wavelength

(Ta=25°C)

W _D RANK	Test Condition	Min.	Typ.	Max.	Unit
A	I _F = 20mA	500	–	505	nm
B		505	–	510	

* Wavelength are tested at a current pulse duration 25ms and an accuracy of ±1 nm.

■ Luminous intensity ranks

(Ta=25°C)

I _v RANK	Test Condition	Min.	Typ.	Max.	Unit
S	I _F = 20mA	3400	–	4800	mcd
T		4800	–	6700	
U		6700	–	9400	
V		9400	–	13000	

* Luminous intensity is tested at a current pulse duration of 25 ms and an accuracy of ±11%.

Intensity Measured : 0.01sr(CIE. LED_B)

■ Forward Voltage ranks

(Ta=25°C)

V _f RANK	Test Condition	Min.	Typ.	Max.	Unit
1	I _F = 20mA	–	3.1	3.3	V
2		3.3	3.5	3.8	

* Voltages are tested at a current pulse duration of 1 ms and an accuracy of ±0.1V.

■ Precautions On LED using

* To avoid optical difference, Please do not mix differently-ranked product.

■ Characteristic Diagrams

Fig. 1 IF-VF

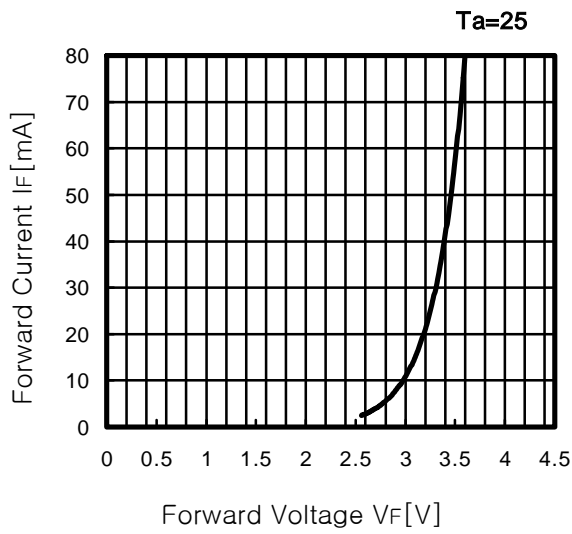

Fig. 2 Iv-IF

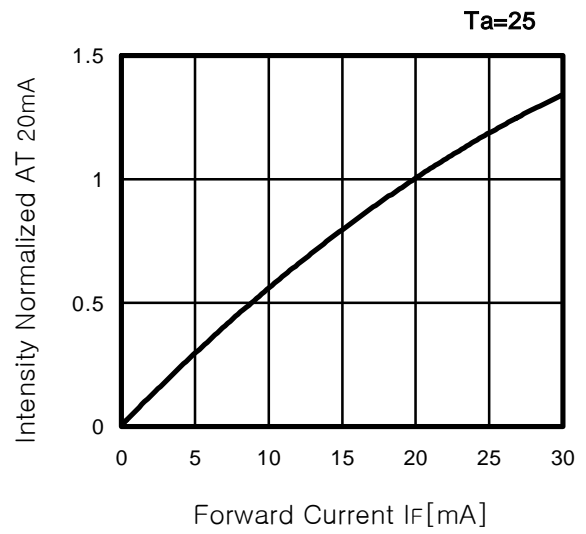

Fig.3 Max. Permissible Forward Current

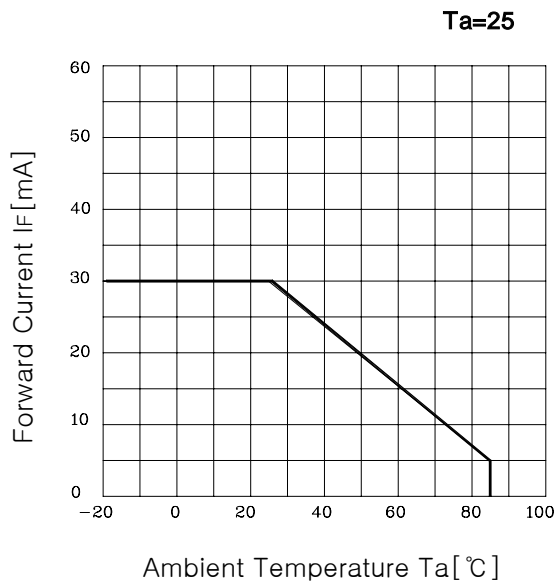

Fig. 3 Spectrum Distribution

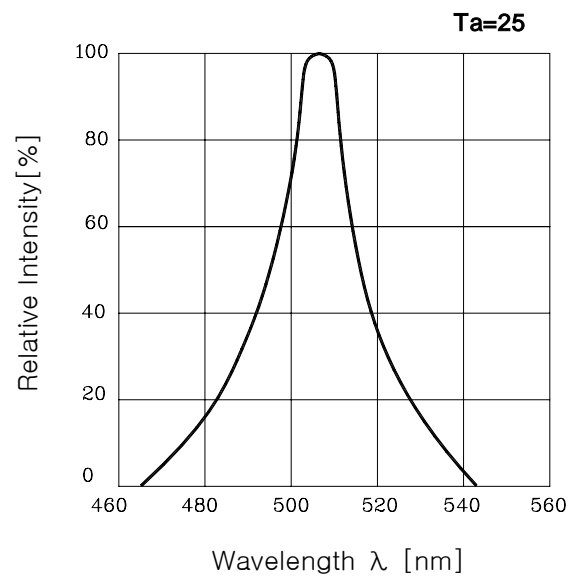

Fig. 4 Relative Intensity - Ta

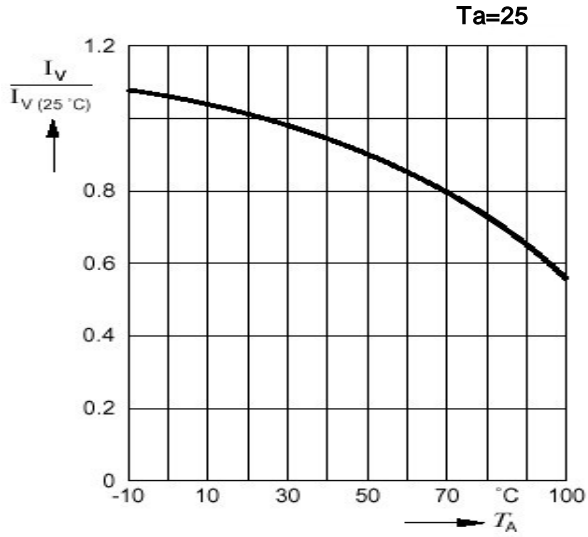
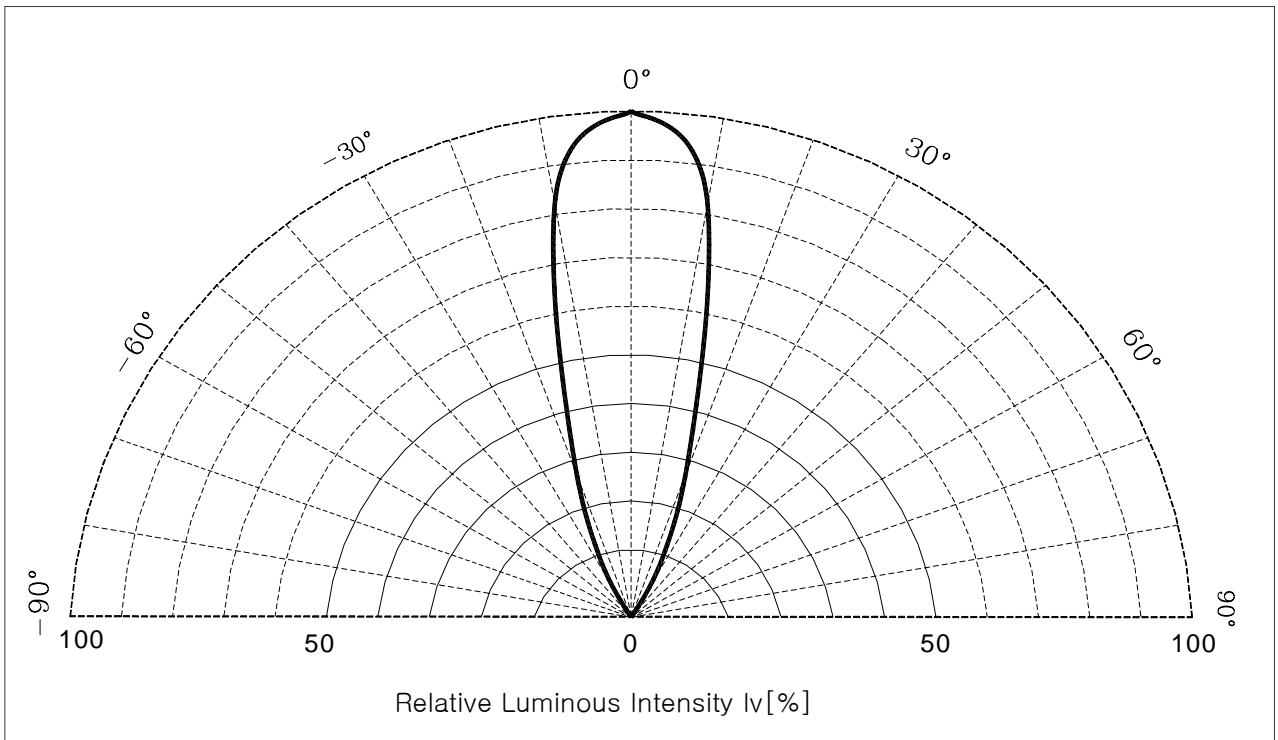

Fig. 5 Radiation Diagram



■ Revision history sheet

Spec NO.			
Title	Specification for Approval		
Times	Date	Summary of revision	Remarks
1	2001. 07. 15	신규제정	
2	2003. 02. 26	Format 변경	
3	2004. 06. 03	lv Rank 변경	