

LCN Series



Due to accurate wire winding technology, these chip inductors are designed for filtering, impedance matching, resonance and choke circuits for RF designer. Both standard series custom designs are available.

Features

- RoHS Compliant
- Ceramic body and Wire wound construction provide high SRFs
- Exceptional Q values even at high frequencies
- Highest possible SRFs as well as excellent Q values
- The non-magnetic coil form assures utmost thermal stability, predictability and batch consistency

Applications

- RF products for cellular phone
- GPS receiver
- Base Station
- Repeater
- Wireless LAN/ mouse/ keyboard/ earphone
- Remote control
- Security system and other RF modules

Product Identification

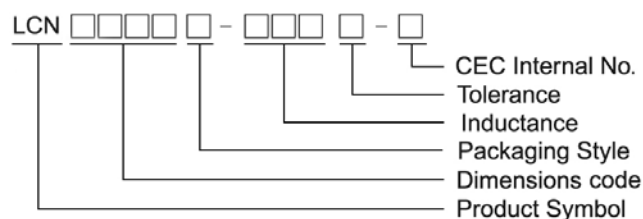

- Packaging: T : Tape and Reel

Shape and Dimensions/ Recommended Pattern

LCN0603/0805/1008/1206

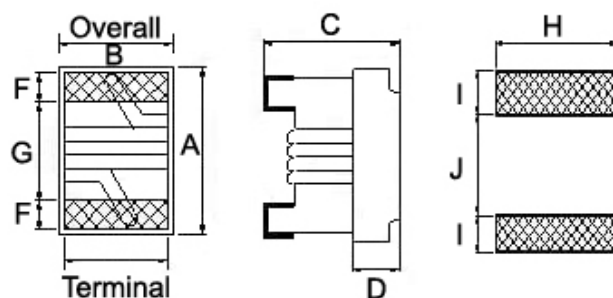

Dimensions

		A Max	B Max	C Max	D	E	F	G	H	I	J
LCN 0603	inch	0.071	0.044	0.04	0.020	0.030	0.013	0.034	0.040	0.025	0.025
	mm	1.80	1.12	1.02	0.51	0.76	0.33	0.86	1.02	0.64	0.64
LCN 0805	inch	0.093	0.068	0.06	0.028	0.050	0.020	0.040	0.070	0.040	0.030
	mm	2.35	1.73	1.52	0.71	1.27	0.51	1.02	1.78	1.02	0.76
LCN 1008	inch	0.115	0.110	0.083	0.046	0.080	0.020	0.060	0.100	0.040	0.050
	mm	2.92	2.79	2.1	1.16	2.03	0.51	1.52	2.54	1.02	1.27
LCN 1206	inch	0.146	0.110	0.087	0.035	0.091	0.020	0.086	0.106	0.039	0.079
	mm	3.70	2.80	2.20	0.90	2.30	0.51	2.18	2.70	1.00	2.00

Electrical Characteristics

Part Number	Inductance (nH)	Test Frequency (MHz)	Tolerance (±%)	Q Min	SRF (MHz) Min	Rdc (Ω) Max	I _{rms} (mA) Max	900 MHz		1.7 GHz		Color
								L Typ.	Q Typ.	L Typ.	Q Typ.	
LCN0603T-1N6□-S	1.6	250	10 / 5	24	12500	0.030	700	1.60	49	1.58	63	Red
LCN0603T-1N8□-S	1.8	250	10 / 5	16	12500	0.045	700	1.60	35	1.66	50	Black
LCN0603T-3N6□-S	3.6	250	10 / 5	22	5900	0.063	700	3.70	53	3.71	65	Red
LCN0603T-3N9□-S	3.9	250	10 / 5	22	6900	0.080	700	3.95	49	3.96	67	Brown
LCN0603T-4N3□-S	4.3	250	10 / 5	22	5900	0.063	700	4.32	50	4.33	70	Orange
LCN0603T-4N7□-S	4.7	250	10 / 5	20	5800	0.116	700	4.72	47	4.75	57	Violet
LCN0603T-5N1□-S	5.1	250	10 / 5	20	5700	0.140	700	4.93	47	4.95	56	Green
LCN0603T-6N3□-S	6.3	250	10 / 5	20	5700	0.140	700	5.50	47	6.1	60	White
LCN0603T-6N8□-S	6.8	250	10 / 5	27	5800	0.110	700	6.75	60	7.1	81	Red
LCN0603T-7N5□-S	7.5	250	10 / 5	28	4800	0.106	700	7.70	60	7.82	65	Brown
LCN0603T-8N2□-S	8.2	250	10 / 5	28	4700	0.109	700	8.30	60	8.50	60	White
LCN0603T-8N7□-S	8.7	250	10 / 5	28	4600	0.109	700	8.86	62	9.32	58	Yellow
LCN0603T-9N5□-S	9.5	250	10 / 5	28	5400	0.135	700	9.70	59	9.92	61	Blue
LCN0603T-10N□-S	10	250	10 / 5 / 2	31	4800	0.130	700	10.0	66	10.6	83	Orange
LCN0603T-11N□-S	11	250	10 / 5 / 2	33	4000	0.086	700	11.0	53	11.5	56	Gray
LCN0603T-12N□-S	12	250	10 / 5 / 2	35	4000	0.130	700	12.3	72	13.5	83	Yellow
LCN0603T-15N□-S	15	250	10 / 5 / 2	35	4000	0.170	700	15.4	64	16.8	89	Green
LCN0603T-16N□-S	16	250	10 / 5 / 2	34	3300	0.104	700	16.2	55	17.3	52	White
LCN0603T-18N□-S	18	250	10 / 5 / 2	35	3100	0.170	700	18.7	70	21.4	69	Blue
LCN0603T-22N□-S	22	250	10 / 5 / 2	38	3000	0.190	700	22.8	73	26.1	71	Violet
LCN0603T-24N□-S	24	250	10 / 5 / 2	37	2650	0.135	700	24.5	45	28.7	39	Black
LCN0603T-27N□-S	27	250	10 / 5 / 2	40	2800	0.220	600	29.2	74	34.6	65	Gray
LCN0603T-30N□-S	30	250	10 / 5 / 2	37	2250	0.144	600	31.4	47	39.9	28	Brown
LCN0603T-33N□-S	33	250	10 / 5 / 2	40	2300	0.220	600	36.0	67	49.5	42	White
LCN0603T-36N□-S	36	250	10 / 5 / 2	38	2080	0.250	600	39.4	47	52.7	24	Red
LCN0603T-39N□-S	39	250	10 / 5 / 2	40	2200	0.250	600	42.7	60	60.2	40	Black
LCN0603T-43N□-S	43	250	10 / 5 / 2	39	2000	0.280	600	47.0	44	64.9	21	Orange
LCN0603T-47N□-S	47	200	10 / 5 / 2	38	2000	0.280	600	52.2	62	77.2	35	Brown
LCN0603T-56N□-S	56	200	10 / 5 / 2	38	1900	0.310	600	62.5	56	97	26	Red
LCN0603T-68N□-S	68	200	10 / 5 / 2	37	1700	0.340	600	80.5	54	168	21	Orange
LCN0603T-72N□-S	72	150	10 / 5 / 2	34	1700	0.490	400	82.0	53	135	20	Yellow
LCN0603T-82N□-S	82	150	10 / 5 / 2	34	1700	0.540	400	96.2	54	177	21	Green
LCN0603T-R10□-S	100	150	10 / 5 / 2	34	1400	0.580	400	124	49			Blue
LCN0603T-R11□-S	110	150	10 / 5 / 2	32	1350	0.610	300	138	43			Violet
LCN0603T-R12□-S	120	150	10 / 5 / 2	32	1300	0.750	300	166	39			Gray
LCN0603T-R15□-S	150	150	10 / 5 / 2	28	990	0.920	280	250	25			White
LCN0603T-R18□-S	180	100	10 / 5 / 2	25	990	1.250	240	305	22			Black
LCN0603T-R22□-S	220	100	10 / 5 / 2	25	900	2.100	200	480	8			Brown
LCN0603T-R27□-S	270	100	10 / 5 / 2	24	900	2.800	170	980	4			Red

- When ordering, please specify tolerance and packaging codes.
- Tolerance : G = ±2% , J = ±5% , K = ±10%
- L/Q: Agilent E4991A+AgilentHP16197A
- SRF: Agilent/HP8753D / Agilent E4991A
- RDC: CH502BC/ HP4338B
- I_{rms} for a 15°C rise above 25°C ambient.
- Operating temperature range from -40°C to 125°C (Including self - temperature rise)

Electrical Characteristics

Part Number	Inductance (nH)	Test Frequency (MHz)	Tolerance (±%)	Q Min	Test Frequency (MHz)	SRF (MHz) Min	Rdc (Ω) Max	Irms (mA) Max	Color
LCN0805T-2N8□-S	2.8	250	10 / 5	70	1500	7900	0.06	800	Gray
LCN0805T-3N0□-S	3.0	250	10 / 5	65	1500	7900	0.06	800	White
LCN0805T-3N3□-S	3.3	250	10 / 5	50	1500	7900	0.08	600	Black
LCN0805T-5N6□-S	5.6	250	10 / 5	65	1000	5500	0.08	600	Orange
LCN0805T-6N8□-S	6.8	250	10 / 5	50	1000	5500	0.11	600	Brown
LCN0805T-7N5□-S	7.5	250	10 / 5	50	1000	4500	0.14	600	Green
LCN0805T-8N2□-S	8.2	250	10 / 5	50	1000	4700	0.12	600	Red
LCN0805T-10N□-S	10	250	10 / 5 / 2	60	500	4200	0.10	600	Blue
LCN0805T-12N□-S	12	250	10 / 5 / 2	50	500	4000	0.15	600	Orange
LCN0805T-15N□-S	15	250	10 / 5 / 2	50	500	3400	0.17	600	Yellow
LCN0805T-18N□-S	18	250	10 / 5 / 2	50	500	3300	0.20	600	Green
LCN0805T-22N□-S	22	250	10 / 5 / 2	55	500	2600	0.22	500	Blue
LCN0805T-24N□-S	24	250	10 / 5 / 2	50	500	2000	0.22	500	Gray
LCN0805T-27N□-S	27	250	10 / 5 / 2	55	500	2500	0.25	500	Violet
LCN0805T-33N□-S	33	250	10 / 5 / 2	60	500	2050	0.27	500	Gray
LCN0805T-36N□-S	36	250	10 / 5 / 2	55	500	1700	0.27	500	Orange
LCN0805T-39N□-S	39	250	10 / 5 / 2	60	500	2000	0.29	500	White
LCN0805T-43N□-S	43	200	10 / 5 / 2	60	500	1650	0.34	500	Yellow
LCN0805T-47N□-S	47	200	10 / 5 / 2	60	500	1650	0.31	500	Black
LCN0805T-56N□-S	56	200	10 / 5 / 2	60	500	1550	0.34	500	Brown
LCN0805T-68N□-S	68	200	10 / 5 / 2	60	500	1450	0.38	500	Red
LCN0805T-82N□-S	82	150	10 / 5 / 2	65	500	1300	0.42	400	Orange
LCN0805T-91N□-S	91	150	10 / 5 / 2	65	500	1200	0.48	400	Black
LCN0805T-R10□-S	100	150	10 / 5 / 2	65	500	1200	0.46	400	Yellow
LCN0805T-R11□-S	110	150	10 / 5 / 2	50	250	1000	0.48	400	Brown
LCN0805T-R12□-S	120	150	10 / 5 / 2	50	250	1100	0.51	400	Green
LCN0805T-R15□-S	150	100	10 / 5 / 2	50	250	920	0.56	400	Blue
LCN0805T-R18□-S	180	100	10 / 5 / 2	50	250	870	0.64	400	Violet
LCN0805T-R20□-S	200	100	10 / 5 / 2	50	250	860	0.70	400	Red
LCN0805T-R22□-S	220	100	10 / 5 / 2	50	250	850	0.70	400	Gray
LCN0805T-R24□-S	240	100	10 / 5 / 2	44	250	690	1.00	350	Red
LCN0805T-R25□-S	250	100	10 / 5 / 2	45	250	660	1.00	350	Yellow
LCN0805T-R27□-S	270	100	10 / 5 / 2	48	250	650	1.00	350	White
LCN0805T-R33□-S	330	100	10 / 5 / 2	48	250	600	1.40	310	Black
LCN0805T-R39□-S	390	100	10 / 5 / 2	25	250	400	1.50	290	Brown
LCN0805T-R47□-S	470	50	10 / 5 / 2	33	100	400	1.76	250	Violet
LCN0805T-R56□-S	560	25	10 / 5 / 2	20	50	200	1.90	230	Orange
LCN0805T-R68□-S	680	25	10 / 5 / 2	18	50	130	2.20	190	Green
LCN0805T-R82□-S	820	25	10 / 5 / 2	15	50	100	2.35	180	Blue

- When ordering, please specify tolerance and packaging codes.
- Tolerance: G = ±2%, J = ±5%, K = ±10%
- Packaging: Clear tape and reel {standard}
- L/Q: Agilent E4991A + AgilentHP16197A
- SRF: Agilent/HP8753D / Agilent E4991A
- RDC: CH502BC/ HP4338B
- I rms for a 15°C rise above 25°C ambient.
- Operating temperature range from -40°C to 125°C. (Including self - temperature rise)

Electrical Characteristics

Part Number	Inductance (nH)	Test Frequency (MHz)	Tolerance (±%)	Q Min	Test Frequency (MHz)	SRF (MHz) Min	Rdc (Ω) Max	Irms (mA) Max	Color Coding		
									1 ST	2 ND	3 RD
LCN1008T-10N□-S	10	50	10 / 5 / 2	50	500	4100	0.08	1000	Brown	Black	Black
LCN1008T-12N□-S	12	50	10 / 5 / 2	50	500	3300	0.09	1000	Brown	Red	Black
LCN1008T-15N□-S	15	50	10 / 5 / 2	50	500	2500	0.10	1000	Brown	Green	Black
LCN1008T-18N□-S	18	50	10 / 5 / 2	50	350	2500	0.11	1000	Brown	Gray	Black
LCN1008T-22N□-S	22	50	10 / 5 / 2	55	350	2400	0.12	1000	Red	Red	Black
LCN1008T-27N□-S	27	50	10 / 5 / 2	55	350	1600	0.13	1000	Red	Violet	Black
LCN1008T-33N□-S	33	50	10 / 5 / 2	60	350	1600	0.14	1000	Orange	Orange	Black
LCN1008T-39N□-S	39	50	10 / 5 / 2	60	350	1500	0.15	1000	Orange	White	Black
LCN1008T-47N□-S	47	50	10 / 5 / 2	65	350	1500	0.16	1000	Yellow	Violet	Black
LCN1008T-56N□-S	56	50	10 / 5 / 2	65	350	1300	0.18	1000	Green	Blue	Black
LCN1008T-68N□-S	68	50	10 / 5 / 2	65	350	1300	0.20	1000	Blue	Gray	Black
LCN1008T-82N□-S	82	50	10 / 5 / 2	60	350	1000	0.22	1000	Gray	Red	Black
LCN1008T-R10□-S	100	25	10 / 5 / 2	60	350	1000	0.56	650	Brown	Black	Brown
LCN1008T-R12□-S	120	25	10 / 5 / 2	60	350	950	0.63	650	Brown	Red	Brown
LCN1008T-R15□-S	150	25	10 / 5 / 2	45	100	850	0.70	580	Brown	Green	Brown
LCN1008T-R18□-S	180	25	10 / 5 / 2	45	100	750	0.77	620	Brown	Gray	Brown
LCN1008T-R22□-S	220	25	10 / 5 / 2	45	100	700	0.84	500	Red	Red	Brown
LCN1008T-R27□-S	270	25	10 / 5 / 2	45	100	600	0.91	500	Red	Violet	Brown
LCN1008T-R33□-S	330	25	10 / 5 / 2	45	100	570	1.05	450	Orange	Orange	Brown
LCN1008T-R39□-S	390	25	10 / 5 / 2	45	100	500	1.12	470	Orange	White	Brown
LCN1008T-R47□-S	470	25	10 / 5 / 2	45	100	450	1.19	470	Yellow	Violet	Brown
LCN1008T-R56□-S	560	25	10 / 5 / 2	45	100	415	1.33	400	Green	Blue	Brown
LCN1008T-R62□-S	620	25	10 / 5 / 2	45	100	375	1.40	300	Blue	Red	Brown
LCN1008T-R68□-S	680	25	10 / 5 / 2	45	100	375	1.47	400	Blue	Gray	Brown
LCN1008T-R75□-S	750	25	10 / 5 / 2	45	100	360	1.54	360	Violet	Green	Brown
LCN1008T-R82□-S	820	25	10 / 5 / 2	45	100	350	1.61	400	Gray	Red	Brown
LCN1008T-R91□-S	910	25	10 / 5 / 2	35	50	320	1.68	380	White	Brown	Brown
LCN1008T-1R0□-S	1000	25	10 / 5 / 2	35	50	220	1.75	370	Brown	Black	Red
LCN1008T-1R2□-S	1200	7.9	10 / 5 / 2	35	50	186	2.0	310	Brown	Red	Red
LCN1008T-1R5□-S	1500	7.9	10 / 5 / 2	28	50	200	2.3	330	Brown	Green	Red
LCN1008T-1R8□-S	1800	7.9	10 / 5 / 2	25	50	170	2.6	300	Brown	Gray	Red
LCN1008T-2R2□-S	2200	7.9	10 / 5 / 2	20	50	110	2.8	280	Red	Red	Red
LCN1008T-2R7□-S	2700	7.9	10 / 5 / 2	15	25	140	3.2	290	Red	Violet	Red
LCN1008T-3R3□-S	3300	7.9	10 / 5 / 2	15	25	100	3.4	290	Orange	Orange	Red
LCN1008T-3R9□-S	3900	7.9	10 / 5 / 2	15	25	100	3.6	260	Orange	White	Red
LCN1008T-4R7□-S	4700	7.9	10 / 5 / 2	13	25	90	4.0	260	Yellow	Violet	Red
LCN1008T-5R6□-S	5600	7.9	10 / 5 / 2	16	7.9	20	4.0	240	Green	Yellow	Red
LCN1008T-6R8□-S	6800	7.9	10 / 5 / 2	18	7.9	40	4.9	200	Yellow	Gray	Red
LCN1008T-8R2□-S	8200	7.9	10 / 5 / 2	18	7.9	25	6.0	170	Gray	Red	Red

- When ordering, please specify tolerance and packaging codes.
- Tolerance: G = ±2% , J = ±5% , K = ±10%
- Packaging: Clear tape and reel {standard}.
- L /Q Agilent E4991A + AgilentHP16197A
- SRF: Agilent/HP8753D / Agilent E4991A
- RDC: CH502BC/ HP4338B
- Irms for a 15°C rise above 25°C ambient.
- Operating temperature range from -40°C to 125°C (Including self - temperature rise)

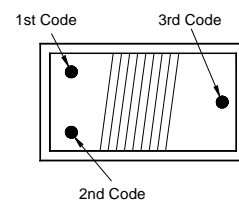

COLOR CODING

Electrical Characteristics

Part Number	Inductance (nH)	Test Frequency (MHz)	Tolerance (±%)	Q Min	Test Frequency (MHz)	SRF (MHz) Min	Rdc (Ω) Max	I _{rms} (mA) Max	Color Coding		
									1 ST	2 ND	3 RD
LCN1206T-3N3□-S	3.3	100	10 / 5	30	300	6200	0.05	1000	Black	Orange	Black
LCN1206T-6N8□-S	6.8	100	10 / 5	30	300	5500	0.07	1000	Black	Blue	Black
LCN1206T-10N□-S	10	100	10 / 5 / 2	40	300	4000	0.08	1000	Brown	Black	Black
LCN1206T-12N□-S	12	100	10 / 5 / 2	40	300	3200	0.08	1000	Brown	Red	Black
LCN1206T-15N□-S	15	100	10 / 5 / 2	40	300	3200	0.10	1000	Brown	Green	Black
LCN1206T-18N□-S	18	100	10 / 5 / 2	50	300	2800	0.10	1000	Brown	Gray	Black
LCN1206T-22N□-S	22	100	10 / 5 / 2	50	300	2200	0.10	1000	Red	Red	Black
LCN1206T-27N□-S	27	100	10 / 5 / 2	50	300	1800	0.11	1000	Red	Violet	Black
LCN1206T-33N□-S	33	100	10 / 5 / 2	55	300	1800	0.11	1000	Orange	Orange	Black
LCN1206T-39N□-S	39	100	10 / 5 / 2	55	300	1800	0.12	1000	Orange	White	Black
LCN1206T-47N□-S	47	100	10 / 5 / 2	55	300	1500	0.13	1000	Yellow	Violet	Black
LCN1206T-56N□-S	56	100	10 / 5 / 2	55	300	1450	0.14	1000	Green	Blue	Black
LCN1206T-68N□-S	68	100	10 / 5 / 2	55	300	1200	0.26	900	Blue	Gray	Black
LCN1206T-82N□-S	82	100	10 / 5 / 2	55	300	1200	0.21	900	Gray	Red	Black
LCN1206T-R10□-S	100	100	10 / 5 / 2	55	300	1100	0.26	850	Brown	Black	Brown
LCN1206T-R12□-S	120	100	10 / 5 / 2	60	300	1100	0.26	800	Brown	Red	Brown
LCN1206T-R15□-S	150	100	10 / 5 / 2	60	300	950	0.31	750	Brown	Green	Brown
LCN1206T-R18□-S	180	50	10 / 5 / 2	60	300	900	0.43	700	Brown	Gray	Brown
LCN1206T-R22□-S	220	50	10 / 5 / 2	60	300	760	0.50	670	Red	Red	Brown
LCN1206T-R27□-S	270	50	10 / 5 / 2	55	300	730	0.56	630	Red	Violet	Brown
LCN1206T-R33□-S	330	50	10 / 5 / 2	45	150	650	0.62	590	Orange	Orange	Brown
LCN1206T-R39□-S	390	50	10 / 5 / 2	45	150	600	0.75	530	Orange	White	Brown
LCN1206T-R47□-S	470	50	10 / 5 / 2	45	150	550	1.30	490	Yellow	Violet	Brown
LCN1206T-R56□-S	560	35	10 / 5 / 2	45	150	470	1.34	460	Green	Blue	Brown
LCN1206T-R62□-S	620	35	10 / 5 / 2	45	150	470	1.58	460	Blue	Red	Brown
LCN1206T-R68□-S	680	35	10 / 5 / 2	45	150	450	1.58	430	Blue	Gray	Brown
LCN1206T-R75□-S	750	35	10 / 5 / 2	45	150	440	2.25	320	Violet	Green	Brown
LCN1206T-R82□-S	820	35	10 / 5 / 2	45	150	420	1.82	400	Gray	Red	Brown
LCN1206T-R91□-S	910	35	10 / 5 / 2	45	150	410	2.95	310	White	Brown	Brown
LCN1206T-1R0□-S	1000	35	10 / 5 / 2	45	150	400	2.80	320	Brown	Black	Red
LCN1206T-1R2□-S	1200	35	10 / 5 / 2	45	150	380	3.20	300	Brown	Red	Red

- When ordering, please specify tolerance and packaging codes.
- Tolerance: G = ±2% , J = ±5% , K = ±10%
- L / Q: Agilent E4991A + AgilentHP16197A
- SRF: Agilent/HP8753D / Agilent E4991A
- RDC: CH502BC/ HP4338B
- I_{rms} for a 15°C rise above 25°C ambient.
- Operating temperature range from -40°C to 125°C . (Including self - temperature rise)

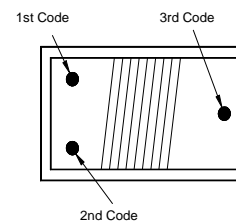

COLOR CODING

SMD Wire Wound Ceramic Chip Inductors - LCN Series

Test Instruments : Agilent E4991A Material/Impedance Analyzer

LCN0603

Typical **L** vs. Frequency

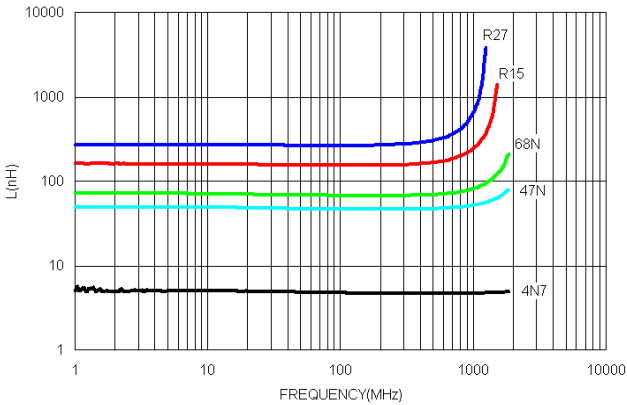

Typical **Q** vs. Frequency

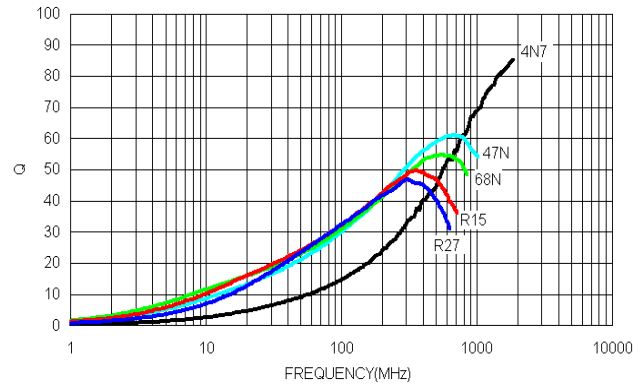

LCN0805

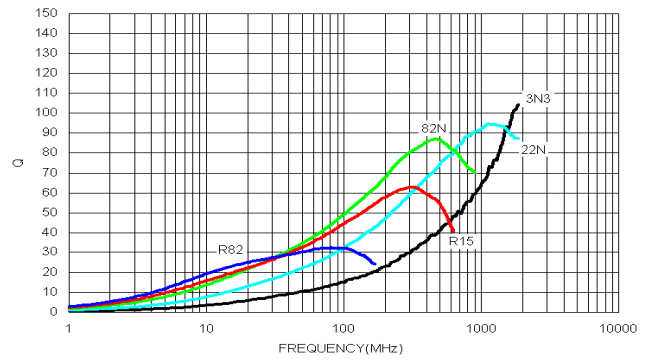
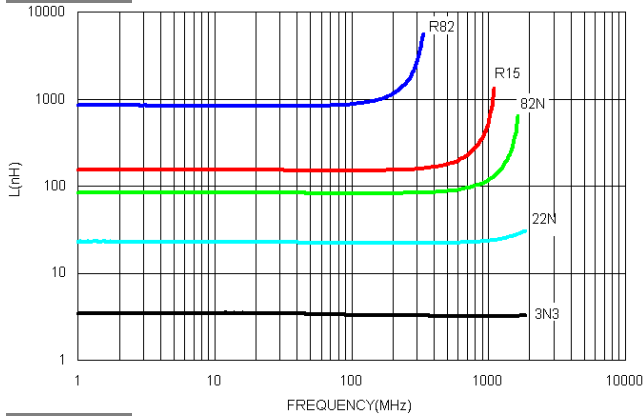

LCN1008

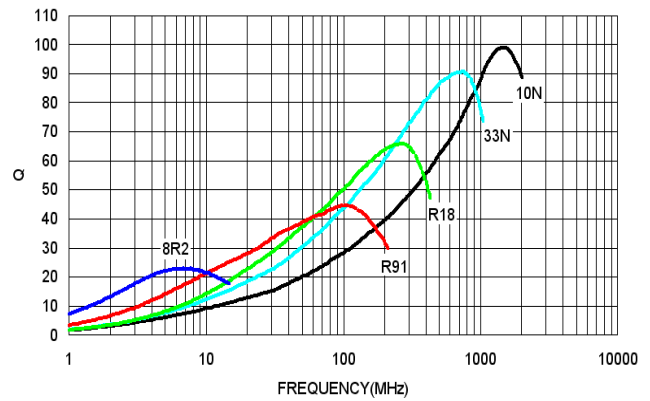
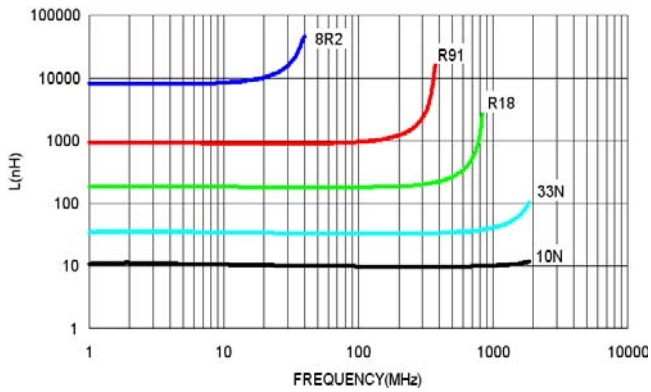

LCN1206

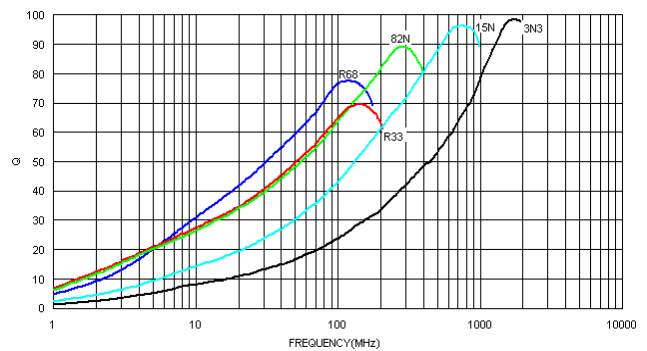
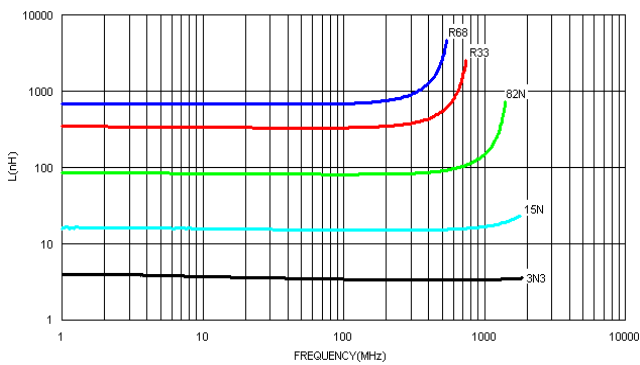

Packaging Specifications

Tape Dimensions

Tape Material

Figure 1

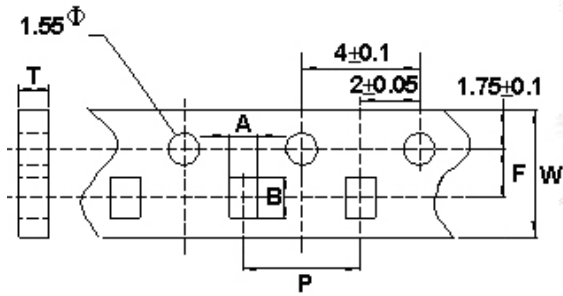

Carrier Tape: Polycarbonate
Cover Tape: Polystyrene

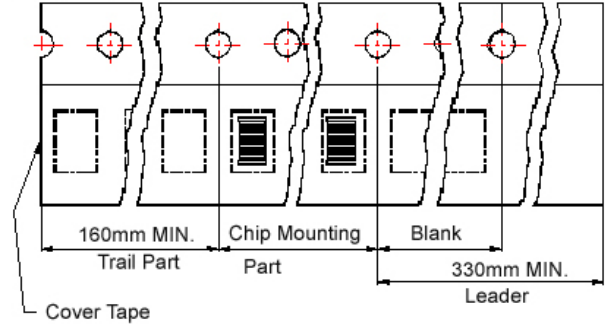
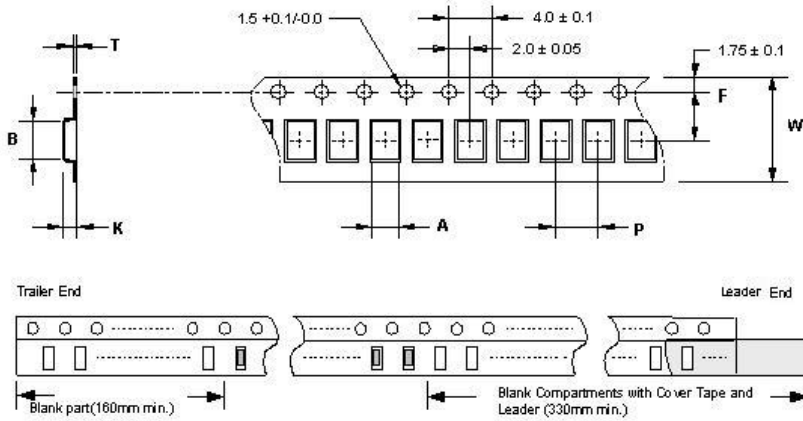
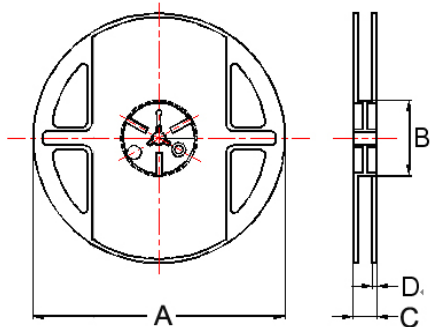

Figure 2



Reel Dimensions



Dimensions in mm

TYPE	Fig.	Tape Dimensions							Reel Dimensions				Quantity PCS / Reel
		A	B	T	W	P	F	K	A	B	C	D	
LCN0603	1	1.16	1.85	0.95	8	4	3.5	-	178	60	12	1.5	4000
LCN0805	2	1.85	2.45	0.23	8	4	3.5	1.50	178	60	12	1.5	2500
LCN1008	2	2.80	2.95	0.23	8	4	3.5	2.20	178	60	12	1.5	2000
LCN1206	2	2.85	3.58	0.25	12	4	5.5	2.55	178	60	16	1.4	2000