

SAMSUNG

LCD TV

LE26M5
LE32M5
LE40M5
LE46M5

- AFTER SALES SERVICE

- Do not hesitate to contact your retailer or service agent if a change in the performance of your product indicates that a faulty condition may be present.

SAMSUNG

ELECTRONICS

Owner's Instructions

Before operating the unit,
please read this manual thoroughly,
and retain it for future reference.



Correct Disposal of This Product

(Waste Electrical & Electronic Equipment)

(Applicable in the European Union and other European countries with separate collection systems)



This marking shown on the product or its literature, indicates that it should not be disposed with other household wastes at the end of its working life. To prevent possible harm to the environment or human health from uncontrolled waste disposal, please separate this from other types of wastes and recycle it responsibly to promote the sustainable reuse of material resources. Household users should contact either the retailer where they purchased this product, or their local government office, for details of where and how they can take this item for environmentally safe recycling.

Business users should contact their supplier and check the terms and conditions of the purchase contract. This product should not be mixed with other commercial wastes for disposal.

ON-SCREEN MENUS
PC DISPLAY
PICTURE IN PICTURE (PIP)
TELETEXT

This device is a Class B digital apparatus.

Register your product at
www.samsung.com/global/register

Precautions When Displaying a Still Image

A still image may cause permanent damage to the TV screen.

- Digital Ready TV: When you select the regular screen (4:3) mode to watch an SD-grade digital broadcast (and the Set-Top Box output is 480p).

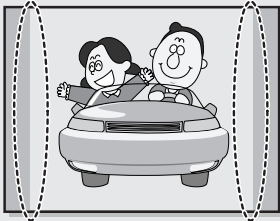

- Digital Ready TV: When you select the wide screen (16:9) mode to watch an SD-grade digital broadcast (and the Set-Top Box output is 1080i).

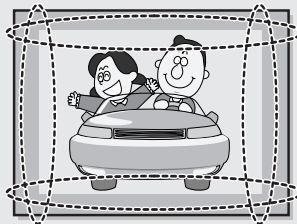

- Digital Ready TV: When the TV receives HD-grade signals (and the Set-Top Box output is 1080i).

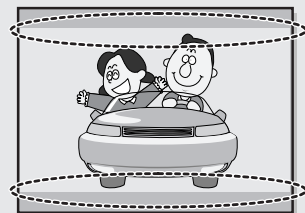

Although digital broadcasting must be in the wide screen (16:9) HD format, broadcasters sometimes show programs made originally in the regular screen format (4:3) by converting the signals into digital form, in which case the left and right side edges of the screen are cropped.

Note : If the borders at the left, right and the center of the screen remain fixed for an extended period of time, the amount of light transmission will also remain varied and as a result the borders may leave traces.

Do not leave the screen in pause mode for extended periods of time as you may experience temporary or permanent image burn.

When you watch a digital HD-grade broadcast on a regular (4:3) TV with the screen size "16:9" or "Panorama" selected, you will be able to watch the program but the top and bottom edges of the screen will be cropped.

Note : If the borders at the top, bottom and the center of the screen remain fixed for an extended period of time, the amount of light transmission will also remain varied and as a result the borders may leave traces.

Do not leave the screen in pause mode for extended periods of time as you may experience temporary or permanent image burn.

- Integrated Digital TV (Wide-screen): When the TV receives SD-grade (regular) broadcasting signals (receives 480p regular signals).

- Digital Ready TV (wide-screen): digital TV: When the TV receives SD-grade (regular) broadcasting signals (with a Set-Top Box).

- When you watch an analog (regular) broadcast on a wide-screen TV (with the 4:3 screen mode selected).

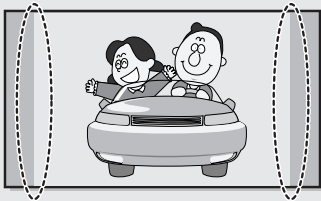

Although digital broadcasting must be in the wide screen (16:9) HD format, broadcasters sometimes show programs made originally in the regular screen format (4:3) by converting the signals into digital form, in which case the left and right side edges of the screen are cropped.

Note : If the borders at the left, right and the center of the screen remain fixed for an extended period of time, the amount of light transmission will also remain varied and as a result the borders may leave traces.

Do not leave the screen in pause mode for extended periods of time as you may experience temporary or permanent image burn.

- When you watch a DVD, CD or a video in wide-screen (21:9) format on a wide-screen (16:9) TV.

- When you connect a computer or a game console to the TV and select the 4:3 screen mode.

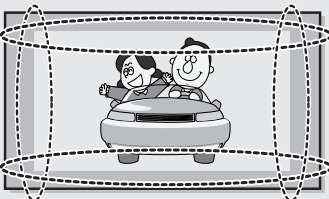

If you connect a DVD player, computer or a game console to the wide-screen TV and watch a movie or play a game in regular (4:3) or wide (21:9) screen mode, the left and right side edges, or the top and bottom edges of the screen will be cropped.

Note : If the borders at the left, right and the center of the screen remain fixed for an extended period of time, the amount of light transmission will also remain varied and as a result the borders may leave traces.

Do not leave the screen in pause mode for extended periods of time as you may experience temporary or permanent image burn.

Contents

◆ CONNECTING AND PREPARING YOUR TV	
■ Viewing the Control Panel	4
■ Viewing the Connection Panel.....	5
- Connecting an Aerial or Cable Television Network	7
- Connecting Component Devices (DTV/DVD)	7
- Connecting External A/V Devices	7
- SERVICE	7
- Connecting Set-Top Box, VCR or DVD	7
- Connecting HDMI/DVI	8
- Connecting Computer	8
- Connecting AUDIO	8
- Kensington Lock	8
■ Viewing the Remote Control (All Functions Except Teletext)	9
■ Viewing the Remote Control (Teletext Functions).....	10
■ Installing Batteries in the Remote Control.....	11
■ Switching On and Off	12
■ Placing Your Television in Standby Mode	13
■ Becoming Familiar with the Remote Control	14
■ Plug and Play	15
■ Choosing Your Language	16
◆ SETTING THE CHANNELS	
■ Storing Channels Automatically	17
■ Storing Channels Manually	18
■ Editing the Channels.....	20
■ Sorting the Stored Channels	21
■ Assigning Channels Names	22
■ Fine Tuning Channel Reception	23
◆ SETTING THE PICTURE	
■ Changing the Picture Standard	24
■ Adjusting the Custom Picture	25
■ Changing the Colour Tone	26
■ Resetting the Picture Settings to the Factory Defaults.....	26
■ Changing the Picture Size	27
■ Freezing the Current Picture.....	27
■ Using the Digital NR (Digital Noise Reduction) Feature.....	28
■ DNle (Digital Natural Image engine)	29
■ My Colour Control	30
■ Dynamic Contrast.....	31
■ Brightness Sensor	32
■ Viewing the Picture In Picture (PIP)	33
◆ SETTING THE SOUND	
■ Adjusting the Volume	35
■ Switching the Sound Off Temporarily	36
■ Selecting the Sound Mode	36
■ Changing the Sound Standard	37
■ Adjusting the Sound Settings	37

Contents

◆ SETTING THE SOUND	
■ Setting the TruSurround XT (SRS TSXT)	38
■ Adjusting the Volume Automatically	39
■ Connecting Headphones	40
■ Selecting the Internal Mute	40
■ Listening to the Sound of the Sub Picture	41
◆ SETTING THE TIME	
■ Setting and Displaying the Current Time	42
■ Setting the Sleep Timer	43
■ Switching the Television On and Off Automatically	44
■ Activating the Child Lock	45
◆ SETTING THE OTHERS	
■ Setting the Blue Screen Mode	46
■ Selecting the Melody	46
■ Selecting a Device from External Sources	47
■ Viewing Pictures from External Sources	48
◆ SETTING THE PC	
■ Setting up Your PC Software (Based on Windows XP)	49
■ Adjusting the PC Screen Automatically	50
■ Coarse and Fine Tuning of the Image	51
■ Changing the Image Position	52
■ Initializing the Image Settings	53
◆ USING THE TELETEXT FEATURE	
■ Teletext Decoder	54
■ Displaying the Teletext Information	54
■ Selecting a Specific Teletext Page	55
■ Using Fasttext to Select a Teletext Page	56
◆ RECOMMENDATIONS FOR USE	
■ Troubleshooting: Before Contacting Service Personnel	57
■ Installing the Wall Mount Kit (LE26M5)	58
■ Installing the Wall Mount Kit (LE32M5, LE40M5, LE46M5)	60
■ Installing the Stand (LE26M5, LE32M5)	62
■ Using the Anti-Theft Kensington Lock	63
■ Technical and Environmental Specifications	64
■ Display Mode (PC)	65
■ Pin Configurations	66

Symbols



Press



Important



Note

Viewing the Control Panel

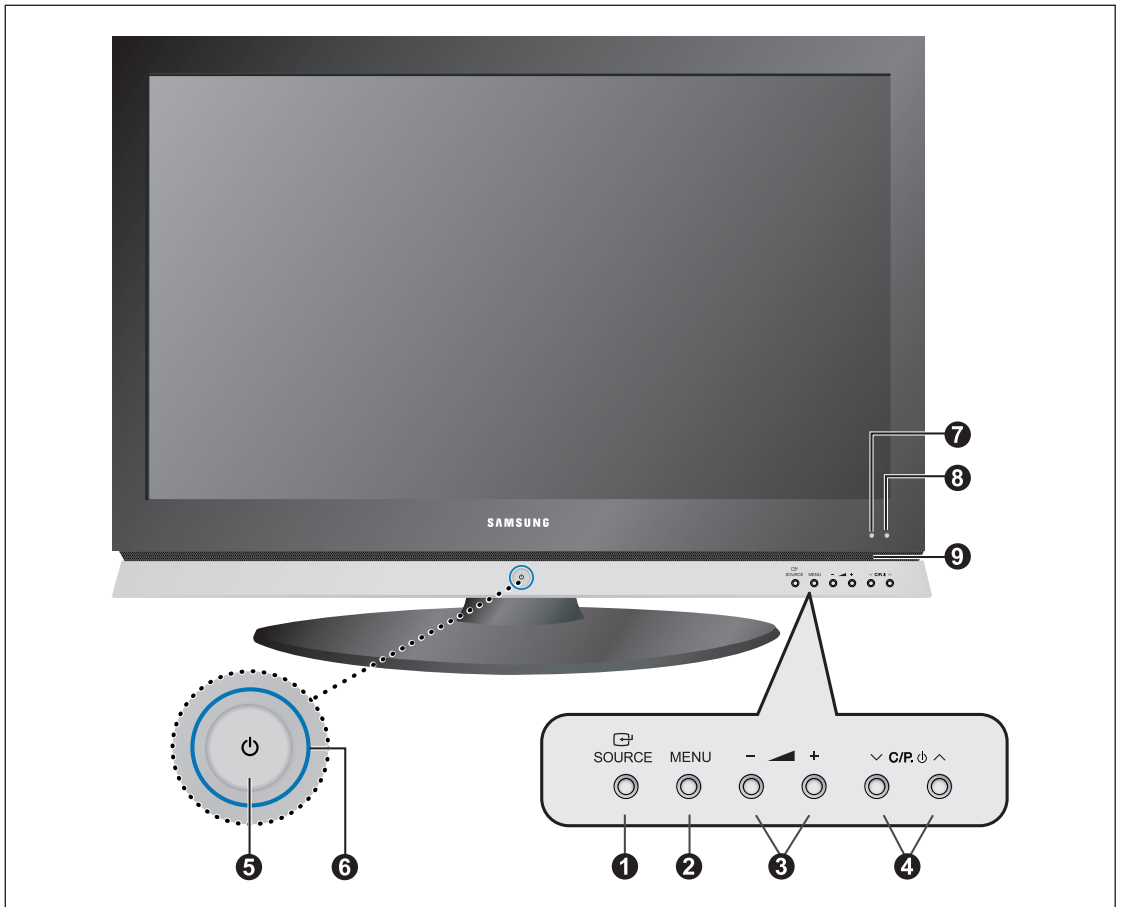

1 SOURCE

Displays a menu of all of the available input sources (TV, Ext. 1, Ext. 2, AV, S-Video, Component, PC, HDMI).

Also used to confirm your choice on the on-screen menu.

2 MENU

Press to see an on-screen menu of your TV's features.

3 - +

Press to decrease or increase the volume. Also used to select items on the on-screen menu.

4 ∨ C/P. ⏻ ∨

Press to change channels.

Also press to highlight various items on the on-screen menu.

(Without the Remote Control, You can turn on TV by using the Channel buttons.)

5 (Power)

Press to turn the TV on and off.

6 Power Indicator

Blinks and turns off when the power is on and lights up in stand-by mode.

7 Remote Control Sensor

Aim the remote control towards this spot on the TV.

8 Light Detecting Sensor

Adjusts brightness of screen automatically by detecting brightness of surrounding environment. This sensor works when Brightness Sensor is on.

9 Speakers

Viewing the Connection Panel

* LE26M5

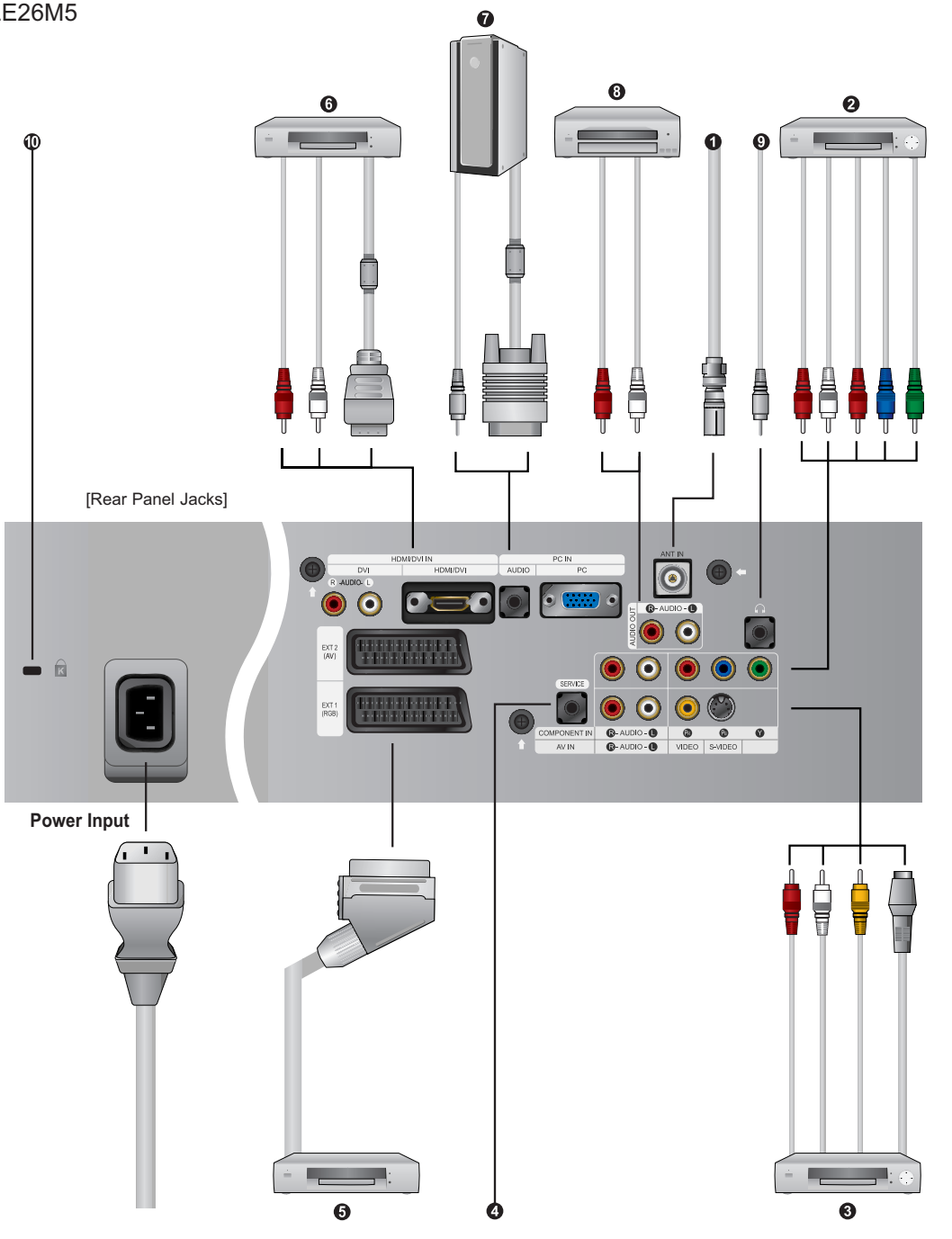

Whenever you connect an audio or video system to your set, ensure that all elements are switched off.
When connecting an external device, match the colour of the connection terminal to the cable.

Viewing the Connection Panel

* LE32M5 / LE40M5 / LE46M5

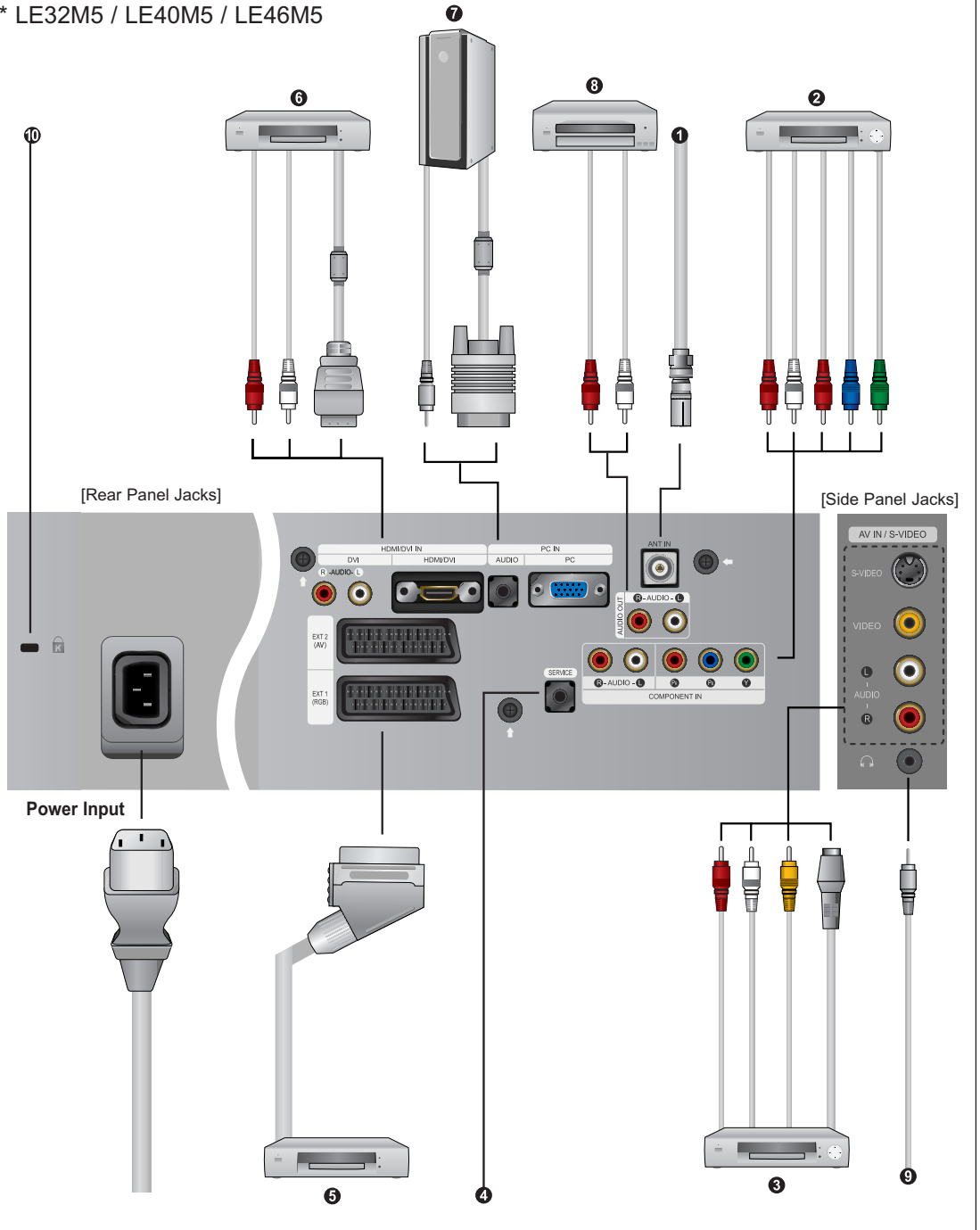

☞ Whenever you connect an audio or video system to your set, ensure that all elements are switched **off**.
When connecting an external device, match the colour of the connection terminal to the cable.

Viewing the Connection Panel

① Connecting an Aerial or Cable Television Network

To view television channels correctly, a signal must be received by the set from one of the following sources:

- An outdoor aerial
- A cable television network
- A satellite network

② Connecting Component Devices (DTV/DVD)

- Connect component video cables to component connector (“**P_R**”, “**P_B**”, “**Y**”) on the rear of your set and the other ends to corresponding component video out connectors on the DTV or DVD.
- If you wish to connect both the Set-Top Box and DTV (or DVD), you should connect the Set-Top Box to the DTV (or DVD) and connect the DTV (or DVD) to component connector (“**P_R**”, “**P_B**”, “**Y**”) on your set.
- The Y, P_B and P_R connectors on your component devices (DTV or DVD) are sometimes labeled Y, B-Y and R-Y or Y, Cb and Cr.
- Connect RCA audio cables to “**R - AUDIO - L**” on the rear of your set and the other ends to corresponding audio out connectors on the DTV or DVD.

③ Connecting External A/V Devices

- Connect RCA or S-VIDEO cable to an appropriate external A/V device such as VCR, DVD or Camcorder.
- Connect RCA audio cables to “**R - AUDIO - L**” on the rear of your set and the other ends to corresponding audio out connectors on the A/V device.
- Headphone may be connected to the headphone output (⑨) on the rear of your set. While the headphone is connected, the sound from the built-in speakers will be disabled.

④ SERVICE

- Connector for engineer.

⑤ Connecting Set-Top Box, VCR or DVD

- Connect the VCR or DVD SCART cable to the SCART connector of the VCR or DVD.
- If you wish to connect both the Set-Top Box and VCR (or DVD), you should connect the Set-Top Box to the VCR (or DVD) and connect the VCR (or DVD) to your set.

➤ Input/Output Specification

Connector	Input				Output
	Video	Audio (R/L)	S-Video	RGB	Video+Audio (R/L)
SCART 1 (EXT 1)	✓	✓		✓	Only TV Out
SCART 2 (EXT 2)	✓	✓			Monitor Out (TV/Ext. 1/Ext. 2/AV/S-VHS)

Viewing the Connection Panel

6 Connecting HDMI/DVI

- Supports connections between HDMI-connection-enabled AV devices (Set-Top Boxes, DVD players, AV receivers and digital TVs).
- No sound connection is needed for an HDMI to HDMI connection.

➤ What is HDMI?

- HDMI, or high-definition multimedia interface, is a next-generation interface that enables the transmission of digital audio and video signals using a single cable without compression.
- "Multimedia interface" is a more accurate name for it especially because it allows multiple channels of digital audio (5.1 channels). The difference between HDMI and DVI is that the HDMI device is smaller in size, has the HDCP (High Bandwidth Digital Copy Protection) coding feature installed, and supports multi - channel digital audio.
- Use the HDMI/DVI terminal for DVI connection to an extended device.

➤ You should use the DVI-to-HDMI cable or DVI-HDMI Adapter for the connection, and the "R - AUDIO - L" terminal on DVI for sound output.

7 Connecting Computer

- Connect the D- Sub cable to "PC (PC IN)" on the rear of your set and the other end to the Video Card of your computer.
- Connect the stereo audio cable to "AUDIO (PC IN)" on the rear of your set and the other end to "Audio Out" of the sound card on your computer.

8 Connecting AUDIO

- Connect RCA audio cables to "R - AUDIO - L" on the rear of your set and the other ends to corresponding audio in connectors on the Amplifier or DVD Home Theater.

	Speaker			SCART2 Out & Audio Out		
	RF	Scart, AV, S-Video	Component, PC, HDMI	RF	Scart, AV, S-Video	Component, PC, HDMI
Internal Mute Off	Speaker Output	Speaker Output	Speaker Output	Sound Output	Sound Output	Sound Output
Internal Mute On	Mute	Mute	Mute	Sound Output	Sound Output	Sound Output
Video No Signal	Mute	Mute	Mute	Mute	Sound Output	Sound Output

10 Kensington Lock

- Refer to "Using the Anti-Theft Kensington Lock" on page 63.
- The place of the Kensington Lock may be different depending on its model.

Viewing the Remote Control (All Functions Except Teletext)

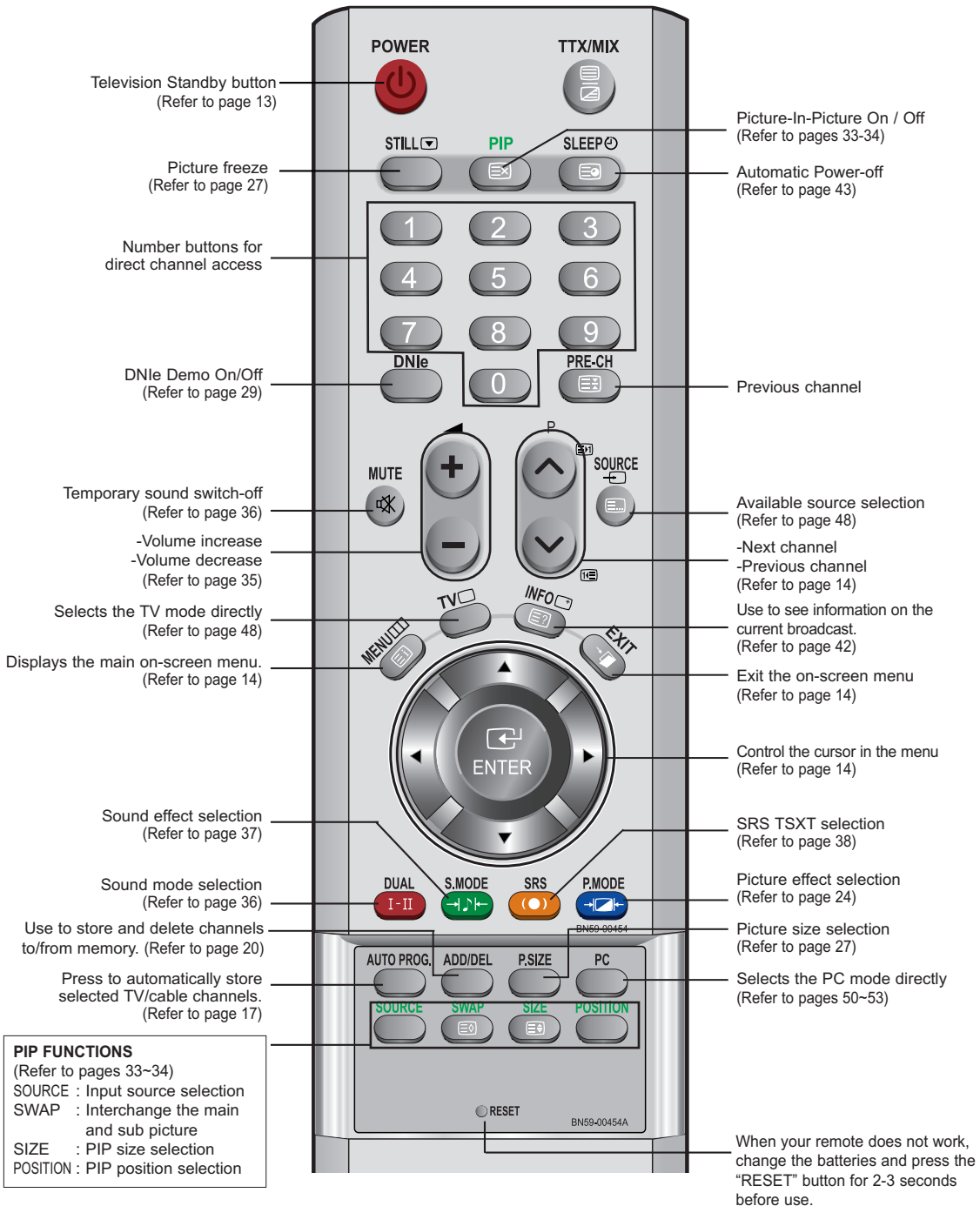

➤ The performance of the remote control may be affected by bright light.

Viewing the Remote Control (Teletext Functions)

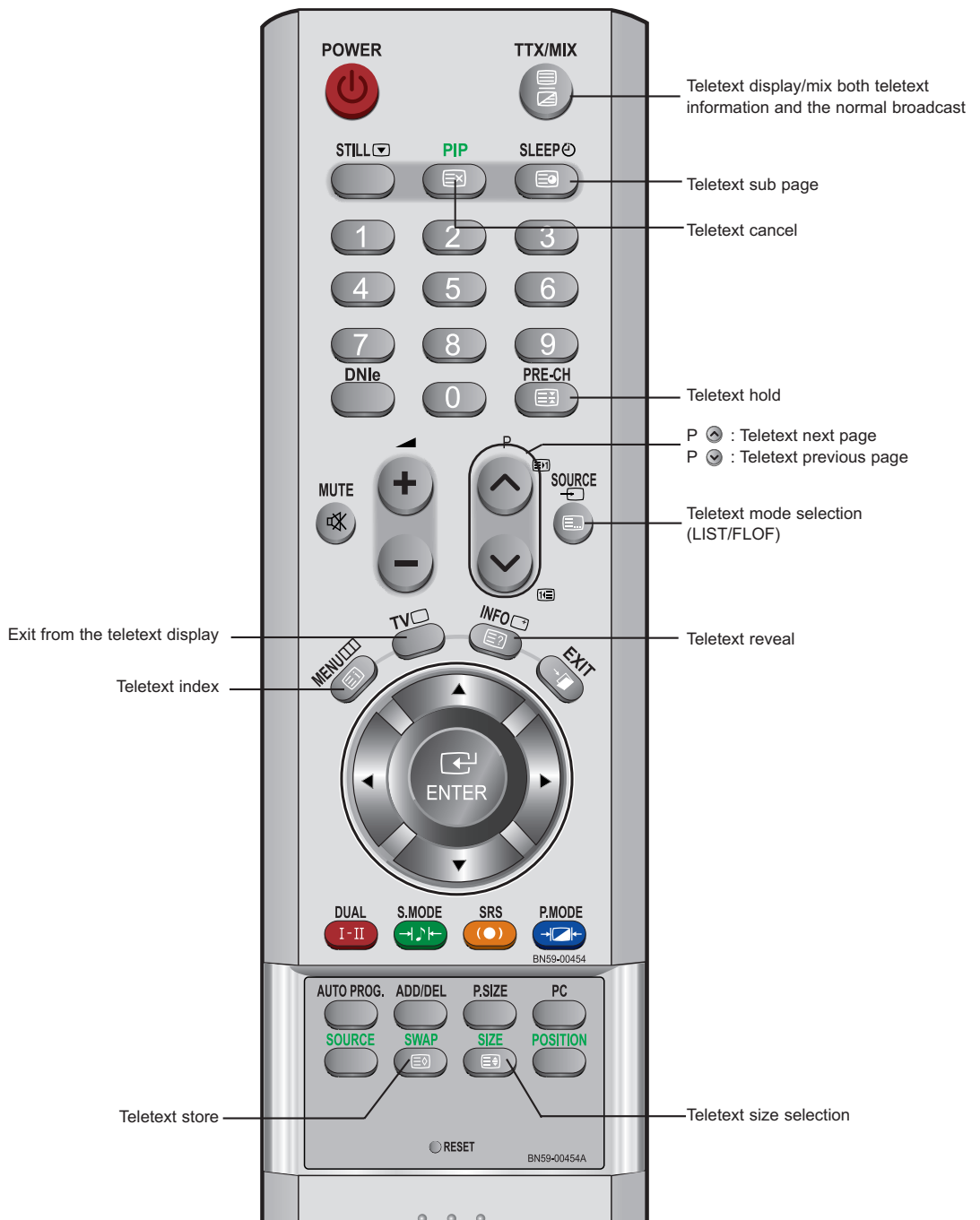

➤ Teletext Function : Refer to pages 54-56 for details

Installing Batteries in the Remote Control

- 1 Slide the cover out completely.
- 2 Install two AAA size batteries.
 - Make sure to match the “+” and “-” ends of the batteries with the diagram inside the compartment.
- 3 Replace the cover.
 - Remove the batteries and store them in a cool, dry place if you won't be using the remote control for a long time. The remote control can be used up to about 23 feet from the TV. (Assuming typical TV usage, the batteries last for about one year.)

➤ **If the remote control doesn't work!**

Check the following:

1. Is the TV power on?
2. Are the plus and minus ends of the batteries reversed?
3. Are the batteries drained?
4. Is there a power cut, or is the power cord unplugged?
5. Is there a special fluorescent light or a neon sign nearby?

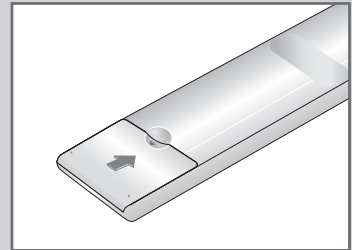
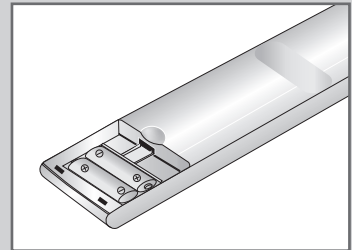
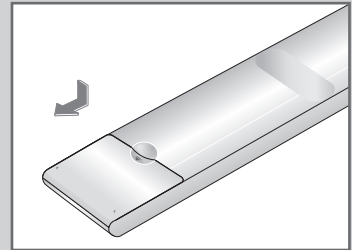

Switching On and Off



The mains lead is attached to the rear of your set.





- 1 Plug the mains lead into an appropriate socket.

Result: The standby indicator lights up on the front panel.

➤ The main voltage is indicated on the rear of your set and the frequency is 50 or 60Hz.

- 2 Press the **POWER**  button on the front of the panel.

Result: The programme that you were watching last is reselected automatically.





- 3 Press the numeric button (0~9) or channel up/down (/) button on the remote control or  **C/P**   button on the lower-right of the panel.

➤ When you switch the set on for the very first time, you will be asked to choose language in which the menus are to be displayed (see page 16).

- 4 To switch your set off, press the **POWER**  button again.

Placing Your Television in Standby Mode

Your set can be placed in standby mode in order to reduce the power consumption. The standby mode can be useful when you wish to interrupt viewing temporarily (during a meal, for example).

- 1 Press the **POWER**  button on the remote control.
Result: The screen is turned off and a red standby indicator appears on the front of your set.
 - 2 To switch your set back on, simply press the **POWER** , numeric buttons (**0~9**) or channel up/down (/) button again.
- Do not leave your set in standby mode for long periods of time (when you are away on holiday, for example).
It is best to unplug the set from the mains and aerial.



Becoming Familiar with the Remote Control

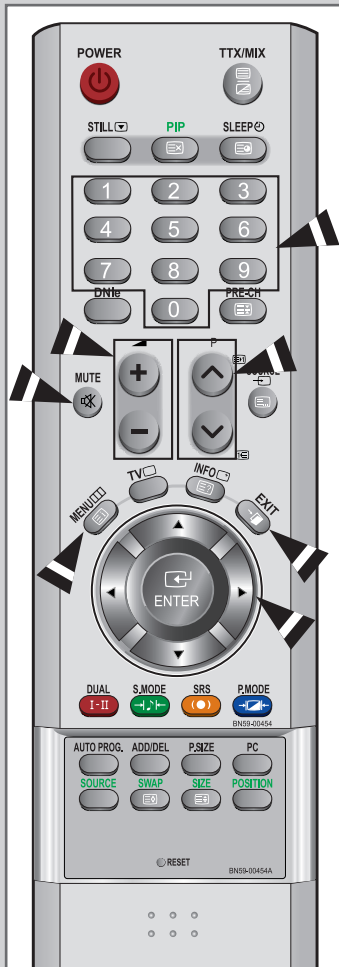

The remote control is used mainly to:

- ◆ Change channels and adjust the volume.
- ◆ Set up your set using the on-screen menu system.

The following table presents the most frequently used buttons and their functions.

Button	Viewing Function	Menu Function
	Used to display the next stored channel.	-
	Used to display the previous stored channel.	-
	Used to display the corresponding channels. ➤ For double digit channels, the second digit must be pushed immediately after the first. Failure to do this will result in a single digit channel being displayed.	-
	Used to increase the volume.	-
	Used to decrease the volume.	-
MUTE 	Used to switch the sound off temporarily. ➤ To turn the sound back on, press this button again, or press the button.	-
MENU 	Used to display the on-screen menu system.	Used to return to the previous menu or normal viewing.
EXIT 	Used to exit the on-screen menu system.	-
	<ul style="list-style-type: none"> ▲ ▼ Used to move among the menu items. ▶ Used to select a menu item or increase the value of the selected item. ◀ Used to return to the previous menu item or decrease the value of the selected item. 	-
	-	Used to confirm your choice.

Plug and Play

When the set is initially powered ON, several basic customer settings proceed automatically and subsequently. The following settings are available.

- 1 If the set is in standby mode, press the **POWER**  button on the remote control.

Result: The message **Start Plug & Play.** is displayed. It appears for a little while, and then the **Language** menu is automatically displayed.

- 2 Select the appropriate language by pressing the **▲** or **▼** button.

➤ The available languages are listed. You can choose one of 21 languages.

- 3 Press the **ENTER**  button to confirm your choice.

Result: The message **Check antenna input.** is displayed with the **OK** selected.

- 4 Press the **ENTER**  button.

Result: The following areas are available:
Belgium - France - Germany - Italy - Netherlands - Spain - Sweden - Switzerland - United Kingdom - Eastern Europe- Others

- 5 Select your **Country** by pressing the **▲** or **▼** button. Press the **ENTER**  button.

Result: The **Auto Store** menu is displayed with the **Start** selected.

- 6 Press the **ENTER**  button.

Result: The channel search will start and end automatically.

- 7 Press the **ENTER**  button. Select the hour or minute by pressing the **◀** or **▶** button. Set the hour or minute by pressing the **▲** or **▼** button. (Refer to "Setting and Displaying the Current Time" on page 42)

- 8 Press the **ENTER**  button to confirm your setting.

Result: The message **Enjoy your watching.** is displayed, and then the channel which has been stored will be activated.



Plug and Play



If you want to reset this feature...

- 1 Press the **MENU** button.
Result: The main menu is displayed.
- 2 Press the **▲** or **▼** button to select **Setup**.
Press the **ENTER** button.
Result: The options available in the **Setup** group are displayed.
- 3 The **Plug & Play** is selected.
- 4 Press the **ENTER** button.
Result: The message **Start Plug & Play.** is displayed.
- 5 For further details on how to set, refer to the previous page.

➤ This function doesn't work when source is in PC mode.

Choosing Your Language



When you start using your set for the first time, you must select the language which will be used for displaying menus and indications.

- 1 Press the **MENU** button.
Result: The main menu is displayed.
- 2 Press the **▲** or **▼** button to select **Setup**.
Result: The options available in the **Setup** group are displayed.
- 3 Press the **ENTER** button.
- 4 Press the **▲** or **▼** button to select **Language**.
Press the **ENTER** button.
Result: The available languages are listed.
- 5 Select a particular language by pressing the **▲** or **▼** button repeatedly.
Press the **ENTER** button.
➤ You can choose one of 21 languages.
- 6 When you are satisfied with your choice, press the **EXIT** button to return to normal viewing.

Storing Channels Automatically

You can scan for the frequency ranges available to you (and availability depends on your country). Automatically allocated programme numbers may not correspond to actual or desired programme numbers. However, you can sort numbers manually and clear any channels you do not wish to watch.

- 1 Press the **MENU** button.
Result: The main menu is displayed.

- 2 Press the **▲** or **▼** button to select **Channel**.
Result: The options available in the **Channel** group are displayed.

- 3 Press the **ENTER** button.
Result: The **Country** is selected.

- 4 Press the **ENTER** button again. Select your **Country** by pressing the **▲** or **▼** button repeatedly.
Result: The following countries are available:
Belgium - France - Germany - Italy - Netherlands - Spain - Sweden - Switzerland - United Kingdom - Eastern Europe- Others

- 5 Press the **ENTER** button.

- 6 Press the **▲** or **▼** button to select **Auto Store**. Press the **ENTER** button.
Result: The **Auto Store** menu is displayed with the **Start** selected.

- 7 Press the **ENTER** button to search the channels. The sub menu is changed from **Start** to **Stop** with channel search started.
Result: The search will end automatically. Channels are sorted and stored in an order which reflects their position in the frequency range (with lowest first and highest last). The programme originally selected is then displayed.
➤ To return to the previous menu, press the **MENU** button.
➤ To stop the search before it has finished, press the **ENTER** button with **Stop** selected.

- 8 When the channels have been stored, you can:
 - ◆ Sort them in the order required (refer to page 21)
 - ◆ Assign names to the stored channels (refer to page 22)
 - ◆ Add or delete the channels (refer to page 20)
 - ◆ Fine tune channel reception if necessary (refer to page 23)

Channels can be stored automatically by simply pressing the **AUTO PROG.** button under the remote's cover.

- 1 Press the **AUTO PROG.** button while viewing a TV programme.
Result: The **Auto Store** menu is displayed with the **Start** selected.

- 2 Press the **ENTER** button.



Storing Channels Manually

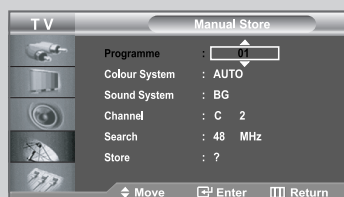
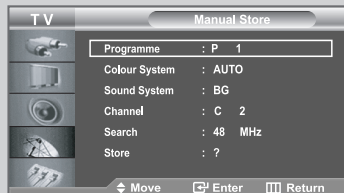

You can store up to 100 channels, including those received via cable networks. When storing channels manually, you can choose:

- ◆ Whether or not to store each of the channels found.
- ◆ The programme number of each stored channel which you wish to identify.

1 Press the **MENU** button.

Result: The main menu is displayed.

2 Press the **▲** or **▼** button to select **Channel**.

Result: The options available in the **Channel** group are displayed.

3 Press the **ENTER** button.

4 Press the **▲** or **▼** button to select **Manual Store**. Press the **ENTER** button.

Result: The options available in the **Manual Store** menu are displayed with **Programme** selected.

5 Press the **ENTER** button again.

To assign a programme number to a channel, find the correct number by pressing the **▲** or **▼** button and then press the **ENTER** button.

➤ You can also set a programme number by pressing number buttons on the remote control.



6 Press the **▲** or **▼** button to select **Colour System** and then press the **ENTER** button. Select the colour standard required by pressing the **▲** or **▼** button repeatedly and then press the **ENTER** button.



Result: The colour standards are displayed in the following order:
AUTO - PAL - SECAM - NTSC 4.43

7 Press the **▲** or **▼** button to select **Sound System** and then press the **ENTER** button. Select the sound standard required by pressing the **▲** or **▼** button repeatedly and then press the **ENTER** button.

Result: The sound standards are displayed in the following order:
BG - DK - I - L

Storing Channels Manually

- 8 If you know the number of the channel to be stored,
- ◆ Press the ▲ or ▼ button to select **Channel** and then press the **ENTER**  button.
 - ◆ Select **C** (Air channel) or **S** (Cable channel) by pressing the ▲ or ▼ button.
 - ◆ Press the ► button to select channel.
 - ◆ Select the required number by pressing the ▲ or ▼ button and then press the **ENTER**  button.
- If there is an abnormal sound or no sound, re-select the sound system required.
- You can also set a channel by pressing number buttons on the remote control.

- 9 If you do not know the channel numbers, press the ▲ or ▼ button to select **Search** and then press the **ENTER**  button. **Search** by pressing the ▲ or ▼ button and then press the **ENTER**  button.

Result: The tuner scans the frequency range until the first channel or the channel that you selected is received on your screen.

- 10 Press the ▲ or ▼ button to select **Store**. Select **OK** by pressing the **ENTER**  button.

Result: The channel and associated programme number are stored.

- 11 Repeat steps 8 to 10 for each channel to be stored.

Channel mode

- ◆ **P** (Programme mode): When tuning is completed, the broadcasting stations in your area will have been assigned to position numbers from P00 to P99. You can select a channel by entering the position number in this mode.
- ◆ **C** (Real channel mode): You can select a channel by entering the assigned number to each broadcast station in this mode.
- ◆ **S** (Cable channel mode): You can select a channel by entering the assigned number to each cable channel in this mode.



Editing the Channels



You can exclude the channels you chose from the channels you scanned. When you scan through the stored channels, those you have chosen to skip are not displayed.

All channels that you do not specifically choose to skip are displayed during scanning.

- 1 Press the **MENU** button.
Result: The main menu is displayed.

- 2 Press the **▲** or **▼** button to select **Channel**.
Press the **ENTER** button.
Result: The options available in the **Channel** group are displayed.

- 3 Press the **▲** or **▼** button to select **Add/Delete**.
Press the **ENTER** button.
Result: The state of the current channel is displayed.

- 4 Press the **▲/▼** button to select channel that you wish to add or delete.
Result: If the channel that you wish to edit is not in memory, the **Add** is selected and displayed. Otherwise, if the channel that you wish to edit is in memory, the **Delete** is selected and displayed.

- 5 Press the **ENTER** button to add or delete channel.

- 6 Press the **MENU** button to return to the previous menu or press the **EXIT** button to return to normal viewing.

- 7 Repeat steps 4 and 5 for each channel to be added or deleted.

➤ You can also add or delete channel by simply pressing the **ADD/DEL** button under the remote's cover.

Sorting the Stored Channels

You can exchange the numbers of two channels, in order to:

- ◆ *Modify the numeric order in which the channels have been automatically stored.*
- ◆ *Give easily remembered numbers to the channels that you watch most often.*

1 Press the **MENU**  button.

Result: The main menu is displayed.

2 Press the **▲** or **▼** button to select **Channel**.

Press the **ENTER**  button.

Result: The options available in the **Channel** group are displayed.

3 Press the **▲** or **▼** button to select **Sort**.

Press the **ENTER**  button.

Result: The **Prog.**, **Ch.** and **Name** are displayed.

4 Select the channel number that you wish to change by pressing the **▲** or **▼** button repeatedly.

Press the **ENTER**  button.

Result: The selected the channel number and name are moved to right side.

5 Press the **▲** or **▼** button to move to the position in which you would like to change and then press the **ENTER**  button.

Result: The selected channel is exchanged with the one previously stored to the chosen number.

6 Repeat steps 4 to 5 for another channel to be sorted.

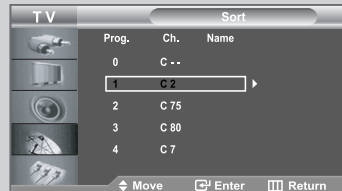
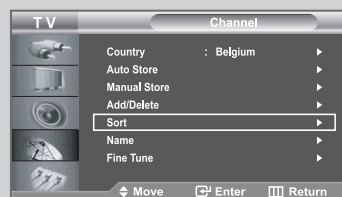

Assigning Channels Names

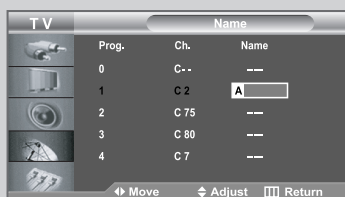
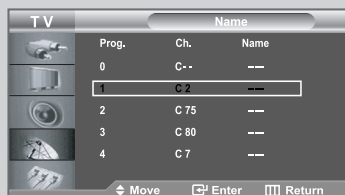

Channel names will be assigned automatically when channel information is broadcast. These names can be changed, allowing you to assign new names.

- 1 Press the **MENU** button.

Result: The main menu is displayed.

- 2 Press the **▲** or **▼** button to select **Channel**.
Press the **ENTER** button.

Result: The options available in the **Channel** group are displayed.

- 3 Press the **▲** or **▼** button to select **Name**.
Press the **ENTER** button.

Result: The current **Prog.**, **Ch.** and **Name** are displayed.

- 4 If necessary, select the channel to be assigned to a new name by pressing the **▲** or **▼** button.
Press the **ENTER** button.

Result: The selection bar is displayed around the name box.

- | 5 | To... | Then... |
|---|-----------------------------------|---------------------------------------|
| | Select a letter, number or symbol | Press the ▲ or ▼ button |
| | Move on the next letter | Press the ▶ button |
| | Move back the previous letter | Press the ◀ button |
| | Confirm the name | Press the ENTER button |

- The characters available are :
- ◆ Letters of the alphabet (A~Z)
 - ◆ Numbers (0~9)
 - ◆ Special characters (-, space)

- 6 Repeat steps 4 to 5 for each channel to be assigned to a new name.

- 7 When you are satisfied with the setting, press the **MENU** button to return to the previous menu or press the **EXIT** button to return to normal viewing.

Fine Tuning Channel Reception

If the reception is clear, you do not have to fine-tune the channel, as this is done automatically during the search and store operation. If, however, the signal is weak or distorted, you may have to fine-tune the channel manually.

➤ Select the channel that you want to fine tune.

- 1 Press the **MENU** button.

Result: The main menu is displayed.

- 2 Press the **▲** or **▼** button to select **Channel**. Press the **ENTER** button.

Result: The options available in the **Channel** group are displayed.

- 3 Press the **▲** or **▼** button to select **Fine Tune**. Press the **ENTER** button.

Result: The horizontal bar is displayed.

- 4 Press the **◀** or **▶** button to reach the required setting. Press the **ENTER** button.

Result: An asterisk "*" appears on the right-hand side of the channel number. The channel number turns red.

➤ To reset the fine-tuning, select **Reset** by pressing the **▲** or **▼** button and then press the **ENTER** button.

- 5 When you are satisfied with the setting, press the **MENU** button to return to the previous menu or press the **EXIT** button to return to normal viewing.

➤ Fine tuned channels that have been saved are marked with an asterisk "*" on the right-hand side of the channel number in the channel banner. And the channel number turns red.

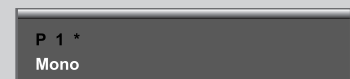
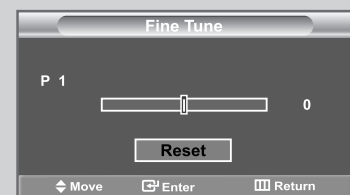
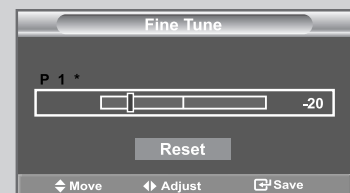
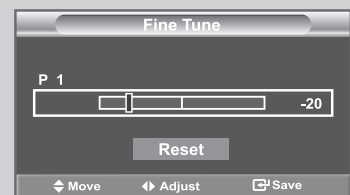
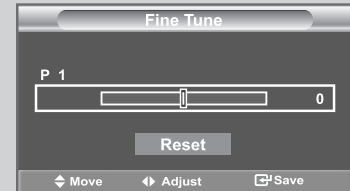

Changing the Picture Standard

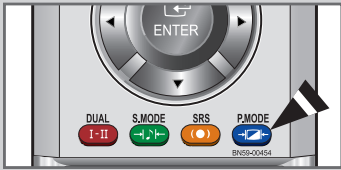
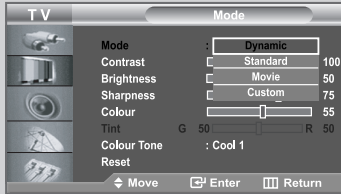
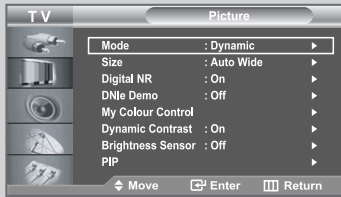

You can select the type of picture which best corresponds to your viewing requirements.

- 1 Press the **MENU** button.

Result: The main menu is displayed.

- 2 Press the **▲** or **▼** button to select **Picture**.

Result: The options available in the **Picture** group are displayed.

- 3 Press the **ENTER** button.

- 4 Press the **ENTER** button again.

Result: The options available in the **Mode** group are displayed.

- 5 Press the **ENTER** button.

Result: The **Mode** is selected.

- 6 Select the required picture effect by pressing the **▲** or **▼** button repeatedly.

Result: The following picture effects are available:

Dynamic - Standard - Movie - Custom

- 7 When you are satisfied with the setting, press the **MENU** button to return to the previous menu or press the **EXIT** button to return to normal viewing.

➤ You can also display by simply pressing the **P.MODE** (Picture Mode) button.

Adjusting the Custom Picture

Your set has several settings which allow you to control picture quality.

- 1 Press the **MENU**  button.

Result: The main menu is displayed.

- 2 Press the **▲** or **▼** button to select **Picture**.

Result: The options available in the **Picture** group are displayed.

- 3 Press the **ENTER**  button.

- 4 Press the **ENTER**  button again.

Result: The options available in the **Mode** group are displayed.

- 5 Select the option (**Contrast**, **Brightness**, **Sharpness**, **Colour**, **Tint**) to be adjusted by pressing the **▲** or **▼** button. Press the **ENTER**  button.

Result: The horizontal bar is displayed.

- 6 Press the **◀** or **▶** button to reach the required setting. Press the **ENTER**  button.

- 7 When you are satisfied with the setting, press the **MENU**  button to return to the previous menu or press the **EXIT** button to return to normal viewing.

-
- ◆ The adjusted values are stored according to the selected Picture mode.
 - ◆ Each adjusted setting will be stored separately according to its input mode.
 - ◆ The Tint is "inactivated" as following cases.
 - Analog mode (RF, Scart, Video, S-Video)
In case of an input signal setting to PAL-50, PAL-CN, and SECAM.
 - Component, DVI, and HDMI mode
In case of an input signal setting to 60HZ; 480i, 480p, 720p @60Hz, 1080i @60Hz.

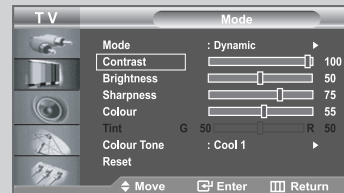
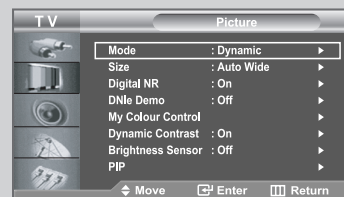

Changing the Colour Tone



You can select the most comfortable colour tone to your eye.

- 1 Press the **MENU** button.
Result: The main menu is displayed.

 - 2 Press the **▲** or **▼** button to select **Picture**.
Result: The options available in the **Picture** group are displayed.

 - 3 Press the **ENTER** button.

 - 4 Press the **ENTER** button again.
Result: The options available in the **Mode** group are displayed.

 - 5 Press the **▲** or **▼** button to select **Colour Tone** and press the **ENTER** button. Select the required option by pressing the **▲** or **▼** button repeatedly. Press the **ENTER** button.
Result: The following options are available:
Cool2 - Cool1 - Normal - Warm1 - Warm2

 - 6 When you are satisfied with your choice, press the **EXIT** button to return to normal viewing.
- The adjusted values are stored according to the selected Picture mode.

Resetting the Picture Settings to the Factory Defaults

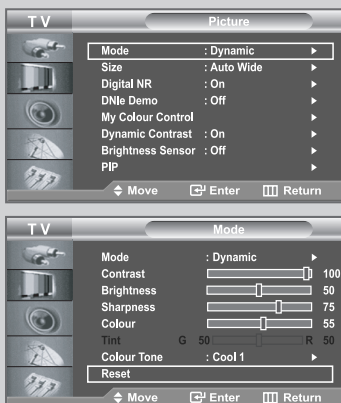

You can return to the factory defaults picture settings.

- 1 Press the **MENU** button.
Result: The main menu is displayed.

 - 2 Press the **▲** or **▼** button to select **Picture**.
Result: The options available in the **Picture** group are displayed.

 - 3 Press the **ENTER** button.

 - 4 Press the **ENTER** button again.
Result: The options available in the **Mode** group are displayed.

 - 5 Press the **▲** or **▼** buttons to select **Reset**, then press the **ENTER** button.

 - 6 Press the **EXIT** button to return to normal viewing.
- The **Reset** will be set each picture mode.

Changing the Picture Size

You can select the picture size which best corresponds to your viewing requirements.

- 1 Press the **MENU** button.

Result: The main menu is displayed.

- 2 Press the **▲** or **▼** button to select **Picture**.

Result: The options available in the **Picture** group are displayed.

- 3 Press the **ENTER** button.



- 4 Press the **▲** or **▼** button to select **Size** and press the **ENTER** button.

- 5 Select the required option by pressing the **▲** or **▼** button repeatedly.

Press the **ENTER** button.

Result: The following options are available:

Auto Wide – Wide – Panorama – Zoom – 4:3

- **Auto Wide:** Automatically adjusts the picture size to the “Wide” aspect ratio.
- **Wide:** Adjusts the picture size to 16:9 appropriate for DVDs or wide broadcasting.
- **Panorama:** Adjusts 16:9 to 4:3 in a natural way as for normal broadcasting.
- **Zoom:** Magnifies the 16:9 wide picture (in the vertical direction) to fit the screen size. Select  by pressing the **◀** or **▶** button. Use the **▲** or **▼** button to move the picture up and down. After selecting , use the **▲** or **▼** button to magnify or reduce the picture size in the vertical direction.
- **4:3:** This is the default setting for a video movie or normal broadcasting.

➤ ◆ You can select these options by simply pressing the **P.SIZE** (Picture Size) button under the remote's cover.

◆ In PC Mode, only **Wide** and **4:3** mode can be adjusted.

◆ If you press **P.SIZE** (Picture Size) button when PIP is set to on, PIP function will be cancelled and the picture size will be changed (except PC mode).

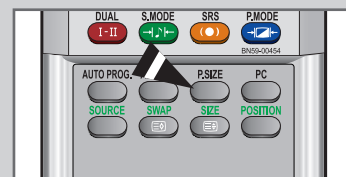
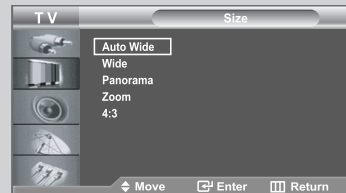
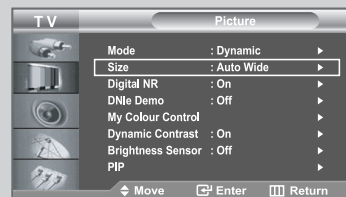

Freezing the Current Picture

Press the **STILL** button to freeze a moving picture into a still one. Press again to cancel.



Using the Digital NR (Digital Noise Reduction) Feature

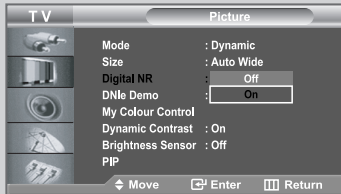
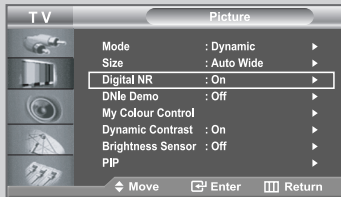

If the signal received by your television is weak, you can activate this feature to help reduce any static and ghosting that may appear on the screen.

1 Press the **MENU** button.

Result: The main menu is displayed.

2 Press the **▲** or **▼** button to select **Picture**.

Result: The options available in the **Picture** group are displayed.

3 Press the **ENTER** button.

4 Press the **▲** or **▼** button to select **Digital NR**.
Press the **ENTER** button.

5 Press the **▲** or **▼** button to select **On**.
Press the **ENTER** button.

6 Press the **EXIT** button to return to normal viewing.

DNle (Digital Natural Image engine)

Samsung's new technology brings you more detailed images with contrast and white enhancement. A new image compensation algorithm gives viewers brighter and clearer images.

DNle technology will match every signal to your eyes.

You can see how DNle improves the picture by setting DNle Demo mode to On.

1 Press the **MENU**  button.

Result: The main menu is displayed.

2 Press the **▲** or **▼** button to select **Picture**.

Result: The options available in the **Picture** group are displayed.

3 Press the **ENTER**  button.

4 Press the **▲** or **▼** button to select **DNle Demo** and then press the **ENTER**  button.

Press the **▲** or **▼** button to select **On**.

Press the **ENTER**  button.

➤ **DNle Demo: Off**
DNle Demo mode is deactivated.

DNle Demo: On
The right-hand side of the screen shows improved DNle image. The left-hand side of the screen shows the original image.

➤ You can also select these options by simply pressing the **DNle** button.

5 When you are satisfied with your choice, press the **EXIT** button to return to normal viewing.

- This function doesn't work when source is in PC mode.
- The **DNle Demo** is designed to show the difference between the regular and DNle pictures.
- By default, the product displays the picture with DNle applied.

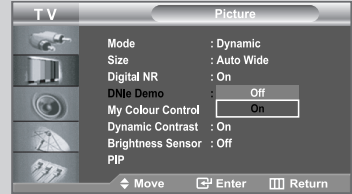
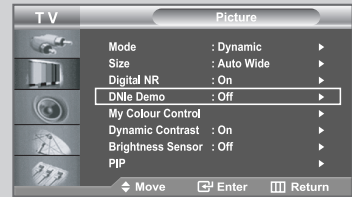

My Colour Control

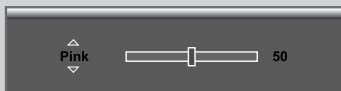
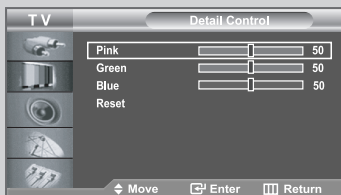
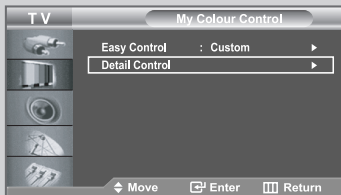
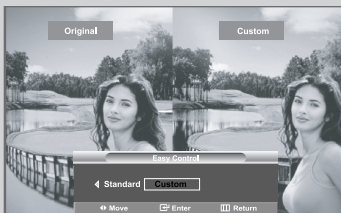
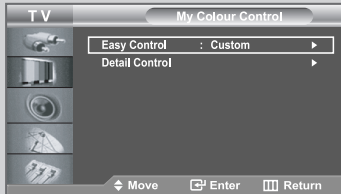
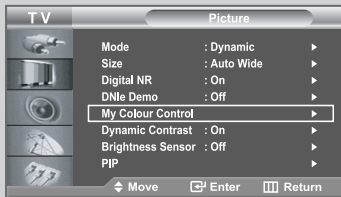

My Colour Control is to adjust the most preferred colours such as Blue, Green, Pink without interfering with other colours in order for each consumer to enjoy the screen colour of his/her choice.

- 1 Press the **MENU** button.

Result: The main menu is displayed.

- 2 Press the **▲** or **▼** button to select **Picture**.

Result: The options available in the **Picture** group are displayed.

- 3 Press the **ENTER** button.

- 4 Press the **▲** or **▼** button to select **My Colour Control** and then press the **ENTER** button.

Result: The options available in the **My Colour Control** menu are displayed.

- 5 Press the **▲** or **▼** button to select **Easy Control** and press the **ENTER** button. Select a source of the sub picture by pressing the **◀** or **▶** button and press the **ENTER** button.

Result: The sources are displayed in the following order:
Blue - Green - Pink - Standard - Custom

- 6 Press the **▲** or **▼** button to select **Detail Control** and press the **ENTER** button. Select a source of the sub picture by pressing the **▲** or **▼** button and press the **ENTER** button.

Result: The sources are displayed in the following order:
Pink - Green - Blue- Reset





- 7 Press the **◀** or **▶** button to reach the required setting. Press the **ENTER** button.

- 8 When you are satisfied with the setting, press the **MENU** button to return to the previous menu or press the **EXIT** button to return to normal viewing.

- This function captures the current screen in a still image to adjust the colour.
- This function doesn't work when source is in PC mode.
- To return to the factory default settings for My Colour Control colours, select **Reset** by pressing the **▲** or **▼** button and then press the **ENTER** button.

Dynamic Contrast

Dynamic Contrast is to automatically detect distribution of inputted visual signal and adjust to create optimum contrast.

- 1 Press the **MENU**  button.
Result: The main menu is displayed.
- 2 Press the **▲** or **▼** button to select **Picture**.
Result: The options available in the **Picture** group are displayed.
- 3 Press the **ENTER**  button.
- 4 Press the **▲** or **▼** button to select **Dynamic Contrast**.
Press the **ENTER**  button.
Result: The **Dynamic Contrast** menu is displayed.
- 5 Select **On** by pressing the **▲** or **▼** button.
Press the **ENTER**  button.
- 6 When it has finished, press the **EXIT** button to return to normal viewing.

➤ This function doesn't work when source is in PC mode or PIP is set to on.

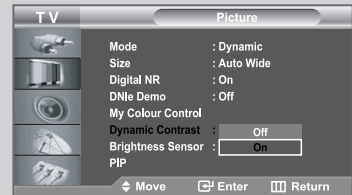
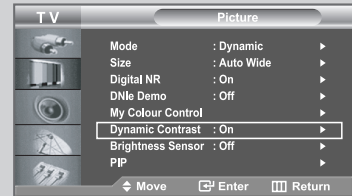
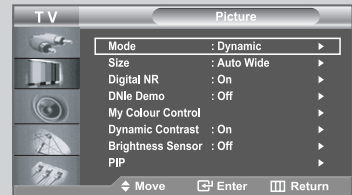

Brightness Sensor

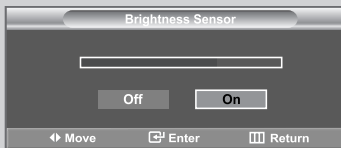
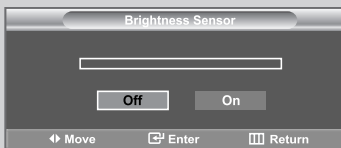
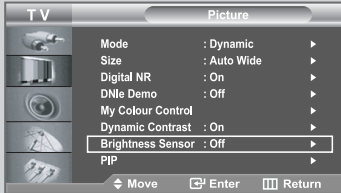
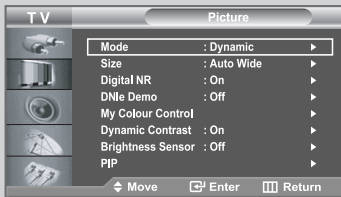

Brightness Sensor is to adjust brightness of screen either automatically or manually by detecting brightness of surrounding environment using light detecting sensor.

- 1 Press the **MENU** button.

Result: The main menu is displayed.

- 2 Press the **▲** or **▼** button to select **Picture**.

Result: The options available in the **Picture** group are displayed.

- 3 Press the **ENTER** button.

- 4 Press the **▲** or **▼** button to select **Brightness Sensor**. Press the **ENTER** button.

Result: The **Brightness Sensor** menu is displayed.

- 5 Select **On** by pressing the **◀** or **▶** button. Press the **ENTER** button.

Result: Brightness on the screen is adjusted automatically according to brightness of surrounding environment.

- 6 When it has finished, press the **ENTER** button to return to the previous menu or press the **EXIT** button to return to normal viewing.

➤ This function doesn't work when source is in PC mode.

Viewing the Picture In Picture (PIP)

You can display a sub picture within the main picture of set programme or video input. In this way, you can watch the picture of set programme or video input from any connected equipment while watching the main picture.

- 1 Press the **MENU**  button.

Result: The main menu is displayed.



- 2 Press the **▲** or **▼** button to select **Picture**.



Result: The options available in the **Picture** group are displayed.

- 3 Press the **ENTER**  button.

- 4 Press the **▲** or **▼** button to select **PIP** and then press the **ENTER**  button.

Result: The options available in the **PIP** menu are displayed.

- 5 Press the **ENTER**  button again. Select **On** by pressing the **▲** or **▼** button and then press the **ENTER**  button.



- 6 Press the **▲** or **▼** button to select **Source** and press the **ENTER**  button. Select a source of the sub picture by pressing the **▲** or **▼** button and press the **ENTER**  button.

Result: The sources are displayed in the following order:
When the main picture is set to TV/Ext.1/Ext.2/AV/S-Video/Component, only HDMI can be selected and when the main picture is set to PC/HDMI, TV/Ext.1/Ext.2/AV/S-Video/Component can be selected.

- 7 Press the **▲** or **▼** button to select **Swap**. To interchange the main picture and the sub picture, select **Swap** option and press the **ENTER**  button.

Result: The main picture and the sub picture are interchanged.

➤ If main picture is in **PC** mode, **Swap** is not available.

- 8 Press the **▲** or **▼** button to select **Size** of the sub picture and then press the **ENTER**  button. Select a size of the sub picture by pressing the **▲** or **▼** button and then press the **ENTER**  button.

Result: The sizes are displayed in the following order:



➤ If main picture is in **PC** mode, **Size** is not available.

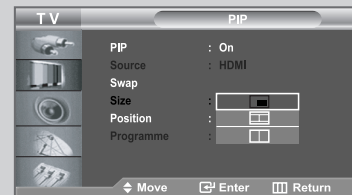
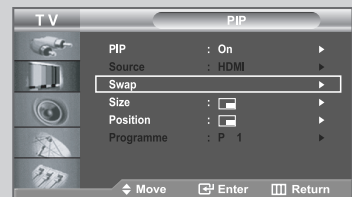
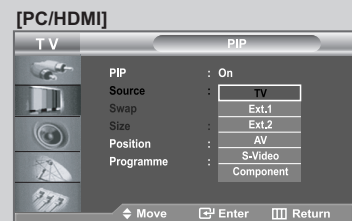
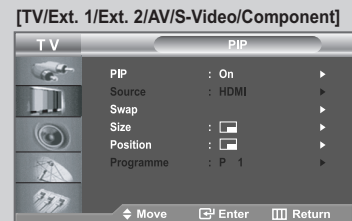
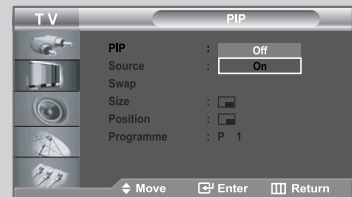
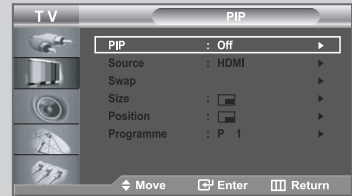
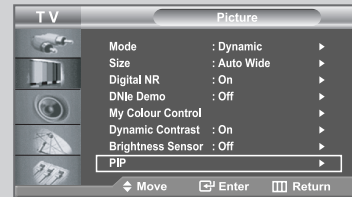

Viewing the Picture In Picture (PIP)

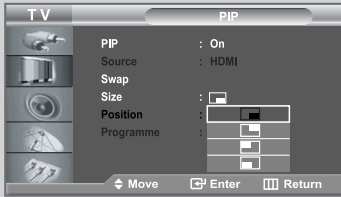

[PC/HDMI]

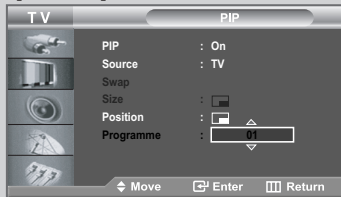

- 9 Press the **▲** or **▼** button to select **Position** and then press the **ENTER** button. Select the position of the sub picture by pressing the **▲** or **▼** button and then press the **ENTER** button.

Result: You can move the sub picture.

➤ When the size of the sub picture is set to or , this feature does not work.

- 10 Press the **▲** or **▼** button to select **Programme** and then press the **ENTER** button. You can select the channel that you want to view through sub picture by pressing the **▲** or **▼** button. Press the **ENTER** button.

Result: The memorized **Programme** is displayed.

➤ **Main: PC/HDMI, Sub: TV**
"Programme" is inactive and not available in TV mode. However, it becomes active and available in PC/HDMI mode.

- 11 To return to normal viewing, press the **EXIT** button.

➤ **Remote-control functions while "PIP" is "On":**

Features	Description
PIP	Used to operate On/Off function of PIP directly.
SOURCE	Used to select a source of the sub picture.
SWAP	Used to interchange the main picture and the sub picture. ➤ When the main picture is in the video mode and the sub picture is in the TV mode, you might not hear the sound of the main picture when pressing the SWAP button after changing the sub picture channel. At this time, reselect the main picture channel.
POSITION	You also move the sub picture simply by pressing the POSITION button.
SIZE	Select a size of the sub picture by pressing the SIZE button.

➤ PIP Settings

O : PIP operates
X : PIP doesn't operate

Main \ Sub	TV	Ext.1	Ext.2	AV	S-Video	Component	PC	HDMI
TV	X	X	X	X	X	X	X	O
Ext.1	X	X	X	X	X	X	X	O
Ext.2	X	X	X	X	X	X	X	O
AV	X	X	X	X	X	X	X	O
S-Video	X	X	X	X	X	X	X	O
Component	X	X	X	X	X	X	X	O
PC	O	O	O	O	O	O	X	X
HDMI	O	O	O	O	O	O	X	X

Adjusting the Volume

You can adjust the volume using your remote control.

Press the **+** button to increase the volume.

Result: A horizontal bar is displayed and the volume increases until you release the button. The cursor moves to the right to indicate the volume.

Press the **-** button to decrease the volume.

Result: A horizontal bar is displayed and the volume decreases until you release the button. The cursor moves to the left to indicate the volume.

➤ Additional sound adjustments are available on your set.
For further details, refer to pages **36** to **41**.



Switching the Sound Off Temporarily



You can switch the sound off temporarily.

Example: You wish to answer the telephone.

- 1 Press the **MUTE** button.
Result: The sound is switched off and **"Mute"** is displayed.
- 2 When you wish to turn the sound back on, press the **MUTE** button again or either of the volume buttons.
Result: The sound comes back on as the same volume as before and the **"Mute"** indication disappears.

Selecting the Sound Mode

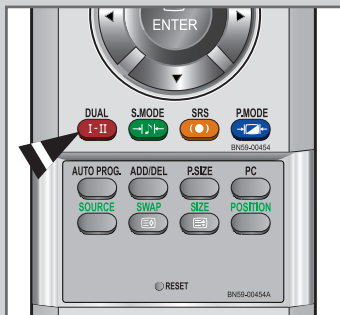

You can set the sound mode by pressing the **"DUAL"** button.

When you press it, the current sound mode is displayed on the screen.

	Audio Type	DUAL 1/2	Default
FM Stereo	Mono	MONO	Automatic change
	Stereo	STEREO ↔ MONO	
	Dual	DUAL 1 ↔ DUAL 2	DUAL 1
	Mono	MONO	Automatic change
Stereo	MONO ↔ STEREO		
NICAM Stereo	Stereo	MONO ↔ STEREO	DUAL 1
	Dual	<div style="border: 1px solid black; padding: 5px; display: inline-block;"> MONO ↔ DUAL 1 DUAL 2 </div>	

- ◆ If the receiving conditions deteriorate, listening will be easier if the mode is set to **Mono**.
- ◆ If the stereo signal is weak and automatic switching occurs, switch to **Mono**.

Changing the Sound Standard

You can select the type of the special sound effect to be used when watching a given broadcast.

- 1 Press the **MENU** button.
Result: The main menu is displayed.
- 2 Press the **▲** or **▼** button to select **Sound**.
Result: The options available in the **Sound** group are displayed.
- 3 Press the **ENTER** button.
- 4 Press the **ENTER** button again.
Result: The **Mode** is selected.
- 5 Select the required sound effect by pressing the **▲** or **▼** button repeatedly and then press the **ENTER** button.
Result: The following sound effects are available:
Standard - Music - Movie - Speech - Custom
- 6 When you are satisfied with the setting, press the **MENU** button to return to the previous menu or press the **EXIT** button to return to normal viewing.

➤ You can also select these options by simply pressing the **S.MODE** (Sound Mode) button on the remote control.

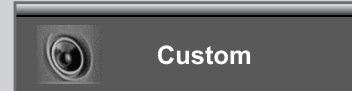
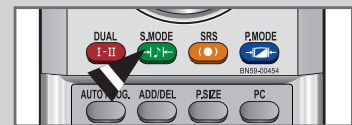
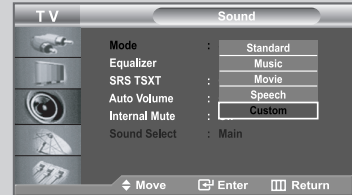
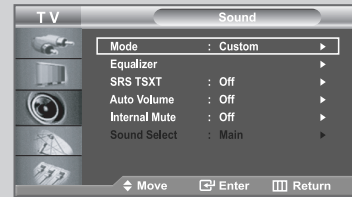

Adjusting the Sound Settings

The sound settings can be adjusted to suit your personal preferences.

- 1 Press the **MENU** button.
Result: The main menu is displayed.
- 2 Press the **▲** or **▼** button to select **Sound**.
Result: The options available in the **Sound** group are displayed.
- 3 Press the **ENTER** button.
- 4 Select **Equalizer** by pressing the **▲** or **▼** button and then press the **ENTER** button.
- 5 Select the required option by pressing the **◀** or **▶** button.
- 6 Press the **▲** or **▼** button to reach the required setting.
Press the **ENTER** button.
- 7 When you are satisfied with the setting, press the **MENU** button to return to the previous menu or press the **EXIT** button to return to normal viewing.

➤ If you make any changes to these settings, the Sound Mode is automatically switched to **Custom**.

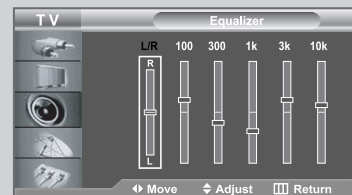
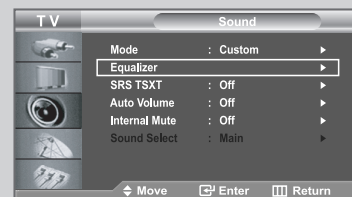

Setting the TruSurround XT (SRS TSXT)

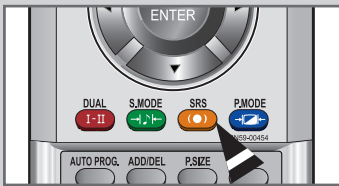
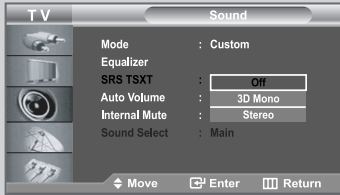
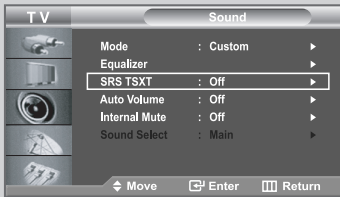

TruSurround XT is a patented SRS technology that solves the problem of playing 5.1 multichannel content over two speakers. TruSurround delivers a compelling, virtual surround sound experience through any two-speaker playback system, including internal television speakers. It is fully compatible with all multichannel formats.

1 Press the **MENU** button.

Result: The main menu is displayed.

2 Press the **▲** or **▼** button to select **Sound**.

Result: The options available in the **Sound** group are displayed.

3 Press the **ENTER** button.

4 Press the **▲** or **▼** button to select **SRS TSXT** and then press the **ENTER** button.

5 Select the required option by pressing the **▲** or **▼** button. Press the **ENTER** button.

Result: The sources are displayed in the following order:
Off - 3D Mono - Stereo

6 Press the **EXIT** button to return to normal viewing.





➤ You can also set these options simply by pressing the **SRS** button on remote control.



TruSurround XT, SRS and  symbol are trademarks of SRS Labs, Inc. TruSurround XT technology is incorporated under license from SRS Labs, Inc.

Adjusting the Volume Automatically

Each broadcasting station has its own signal conditions, and so it is not easy for you to adjust the volume every time the channel is changed. This feature let you automatically adjust the volume of the desired channel by lowering the sound output when the modulation signal is high or by raising the sound output when the modulation signal is low.

- 1 Press the **MENU**  button.
Result: The main menu is displayed.
- 2 Press the **▲** or **▼** button to select **Sound**.
Press the **ENTER**  button.
Result: The options available in the **Sound** group are displayed.
- 3 Press the **▲** or **▼** button to select **Auto Volume**.
Press the **ENTER**  button.
- 4 Press the **▲** or **▼** button to select **On**.
Press the **ENTER**  button.
- 5 Press the **EXIT** button to return to normal viewing.

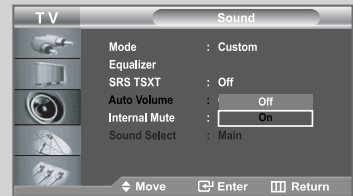
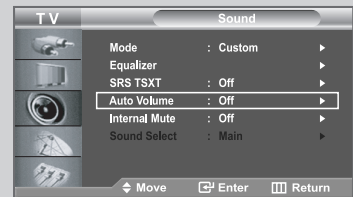

Connecting Headphones



You can connect a set of headphones to your set if you wish to watch a TV programme without disturbing the other people in the room.

Plug a set of headphones into the 3.5mm mini-jack socket on the rear panel of the set.

Result: The sound is heard through the headphones.

- For further details on how to set your headphone preferences, refer to the section below.
- When you insert the head set jack into the corresponding port, you can operate only **SRS TSXT**, **Internal Mute** and **Sound Select** (in PIP mode) in Sound menu.

- Prolonged use of headphones at a high volume may damage your hearing.
- You will not receive sound from the speakers when you connect headphones to the system.

Selecting the Internal Mute

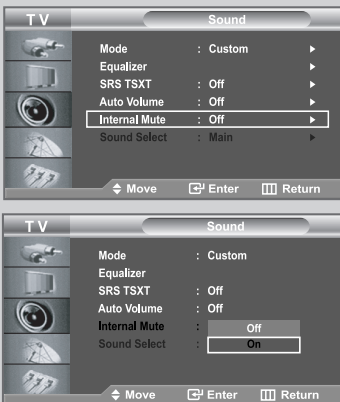

If you want to hear the sound through separate speakers, cancel the internal amplifier.

- 1 Press the **MENU** button.

Result: The main menu is displayed.

- 2 Press the **▲** or **▼** button to select **Sound**.

Result: The options available in the **Sound** group are displayed.

- 3 Press the **ENTER** button.

- 4 Press the **▲** or **▼** button to select **Internal Mute**. Press the **ENTER** button.





- 5 Press the **▲** or **▼** button to select **On**. Press the **ENTER** button.

- 6 Press the **EXIT** button to return to normal viewing.

- When **Internal Mute** is set to **On**, the Sound menus except for **Sound Select** (in PIP mode) cannot be adjusted.

Listening to the Sound of the Sub Picture

During the PIP feature is activating, you can listen to the sound of the sub picture.

- 1 Press the **MENU**  button.
Result: The main menu is displayed.
- 2 Press the **▲** or **▼** button to select **Sound**.
Result: The options available in the **Sound** group are displayed.
- 3 Press the **ENTER**  button.
- 4 Press the **▲** or **▼** button to select **Sound Select** and then press the **ENTER**  button.
Result: **Main** and **Sub** are displayed.
➤ You can select this option when the PIP is in “On”.
- 5 Select the **Sub** by pressing the **▲** or **▼** button.
Press the **ENTER**  button.
Result: You can listen to the sound of the sub picture.
➤ To listen the sound of the current main picture, set to **Main**.

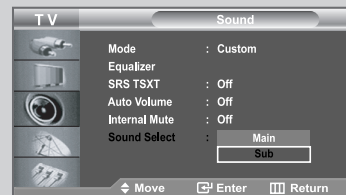
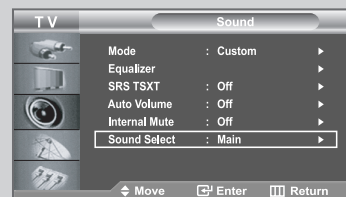

Setting and Displaying the Current Time

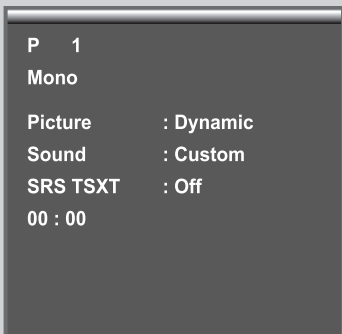
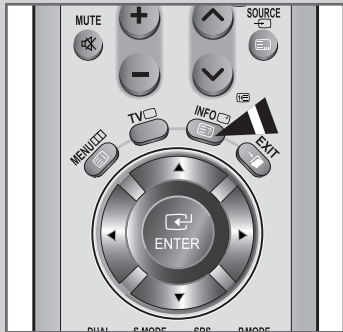
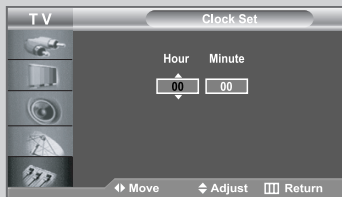
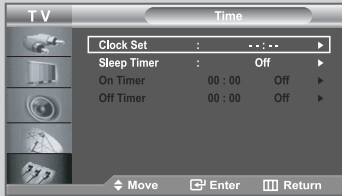

You can set the TV's clock so that the current time is displayed when you press the **INFO** button. You must also set the time if you wish to use the automatic On/Off timers.

➤ If you disconnect the power cord, you have to set the clock again.

1 Press the **MENU** button.

Result: The main menu is displayed.

2 Press the **▲** or **▼** button to select **Setup**.
Press the **ENTER** button.

Result: The options available in the **Setup** group are displayed.

3 Press the **▲** or **▼** button to select **Time**.
Press the **ENTER** button.

Result: The **Time** menu is displayed with **Clock Set** selected.

4 Press the **ENTER** button.

5 **To...** **Press the...**

Move to **Hour** or **Minute** ◀ or ▶ button

Set the **Hour** or **Minute** ▲ or ▼ button

Press the **ENTER** button.

6 When you are satisfied with the setting, press the **MENU** button to return to the previous menu or press the **EXIT** button to return to normal viewing.

7 **To display the...** **Press the...**

Current time and selected audio/video setting status **INFO** button

➤ You can also set hour and minute by pressing the number buttons on the remote control.

Setting the Sleep Timer

You can select a time period of between 30 and 180 minutes after which the television automatically switches to standby mode.

- 1 Press the **MENU** button.
Result: The main menu is displayed.
- 2 Press the **▲** or **▼** button to select **Setup**.
Press the **ENTER** button.
Result: The options available in the **Setup** group are displayed.
- 3 Press the **▲** or **▼** button to select **Time**.
Press the **ENTER** button.
Result: The **Time** menu is displayed with **Clock Set** selected.
- 4 Press the **▲** or **▼** button to select **Sleep Timer**.
Press the **ENTER** button.
- 5 Press the **▲** or **▼** button repeatedly and cycle through the preset time intervals (Off, 30, 60, 90, 120, 150, 180).
Press the **ENTER** button.
Result: The TV automatically switches to standby mode when the timer reaches 0.
- 6 To cancel the sleep timer function, select **Off** by pressing the **▲** or **▼** button and then press the **ENTER** button.
- 7 Press the **EXIT** button to return to normal viewing.

You can set the sleep timer by simply pressing the **SLEEP** button on the remote control.

- 1 Press the **SLEEP** button on the remote control.
Result: If the sleep timer is not yet set, **Off** is displayed.
Otherwise, the remaining time before which the television switches to standby mode is displayed.
- 2 Select the preset time interval for staying on by pressing the **SLEEP** button repeatedly.

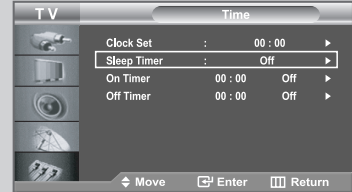
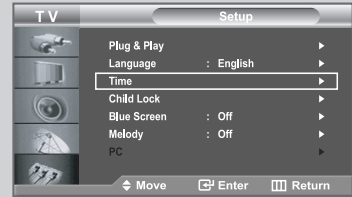

Switching the Television On and Off Automatically

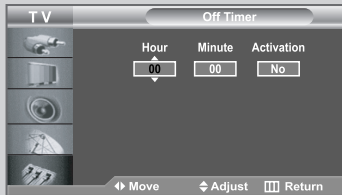
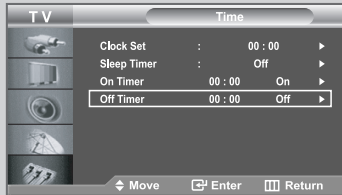
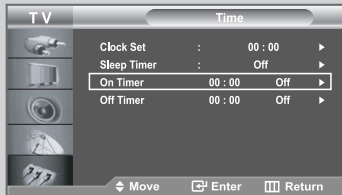

You can set the On/Off timers so that the set will:

- ◆ Switch on automatically and tune to the channel of your choice at the time you select.
- ◆ Switch off automatically at the time you select.

➤ The first step is to set the television's clock (refer to "Setting and Displaying the Current Time" on page 42).

1 Press the **MENU** button.

Result: The main menu is displayed.

2 Press the **▲** or **▼** button to select **Setup**. Press the **ENTER** button.

Result: The options available in the **Setup** group are displayed.

3 Press the **▲** or **▼** button to select **Time**. Press the **ENTER** button.

Result: The **Time** menu is displayed with **Clock Set** selected.

4 Press the **▲** or **▼** button to select **On Timer**. Press the **ENTER** button.

Result: The **On Timer** menu is displayed.

5 Set the time, channel and volume level at which you wish the set to be switched on.

To...	Press the...
Move to Hour , Minute , Programme , and Volume	◀ or ▶ button
Set Hour , Minute , Programme , and Volume	▲ or ▼ button
Move to Activation	◀ or ▶ button
Select Yes to enable above setting	▲ or ▼ button

Press the **ENTER** button.









6 Press the **▲** or **▼** button to select **Off Timer**. In the same way, set the time at which you wish the set to be switched off automatically.

➤ You can also set hour and minute by pressing the number buttons on the remote control.

Activating the Child Lock

This feature allows you to prevent unauthorized users, such as children, from watching unsuitable programmes by muting out video and audio. Child Lock cannot be released using the buttons on the lower-right panel. Only the remote control can release the Child Lock setting, so keep the remote control away from children.

➤ *This function does not work in PC mode.*

- 1 Press the **MENU**  button.
Result: The main menu is displayed.
- 2 Press the **▲** or **▼** button to select **Setup**.
Press the **ENTER**  button.
Result: The options available in the **Setup** group are displayed.
- 3 Press the **▲** or **▼** button to select **Child Lock**.
Press the **ENTER**  button.
Result: The options available in the **Child Lock** group are displayed.
- 4 Press the **ENTER**  button again.
Result: The **Child Lock** is selected.
- 5 Press the **▲** or **▼** button to select **On**.
Press the **ENTER**  button.
- 6 Press the **▲** or **▼** button to select **Programme**.
Press the **ENTER**  button.
- 7 Press the **▲** or **▼** button to select the channels to lock.
Press the **ENTER**  button.
- 8 Press the **▲** or **▼** button to select **Lock**.
Press the **ENTER**  button.
- 9 Press the **▲** or **▼** button to select **Locked** to lock the channels.
Press the **ENTER**  button.
- 10 Repeat steps 6 and 9 for each channel to be locked or unlocked.
- 11 Press the **EXIT** button to return to normal viewing.

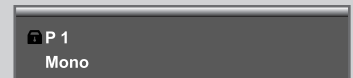

Setting the Blue Screen Mode

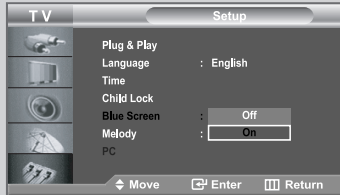

If no signal is being received or the signal is very weak, a blue screen automatically replaces the noisy picture background.

If you wish to continue viewing the poor picture, you must set the "Blue Screen" mode to "Off".

- 1 Press the **MENU** button.

Result: The main menu is displayed.

- 2 Press the **▲** or **▼** button to select **Setup**.
Press the **ENTER** button.

Result: The options available in the **Setup** group are displayed.

- 3 Press the **▲** or **▼** button to select **Blue Screen**.
Press the **ENTER** button.

- 4 Press the **▲** or **▼** button to select **On**.
Press the **ENTER** button.

- 5 Press the **EXIT** button to return to normal viewing.

Selecting the Melody



You can hear melody sound when the television is powered on or off.

- 1 Press the **MENU** button.

Result: The main menu is displayed.

- 2 Press the **▲** or **▼** button to select **Setup**.
Press the **ENTER** button.

Result: The options available in the **Setup** group are displayed.



- 3 Press the **▲** or **▼** button to select **Melody**.
Press the **ENTER** button.

- 4 Press the **▲** or **▼** button to select **On**.
Press the **ENTER** button.

- 5 Press the **EXIT** button to return to normal viewing.

Selecting a Device from External Sources

Your set enables you to choose which audio/video signals are output to the external connector.

- 1 Press the **MENU**  button.
Press the **ENTER**  button to select **Input**.
Result: The options available in the **Input** group are displayed.

- 2 Press the **ENTER**  button.
Result: The options available in the **Source List** menu are displayed.
➤ When no external device is connected to your set, only **TV**, **Ext.1**, **Ext.2** are activated in the **Source List**. **AV**, **S-Video**, **Component**, **PC**, **HDMI** are activated only when they are connected to your set.

- 3 Select the required device by pressing the **▲** or **▼** button.
Press the **ENTER**  button.

- 4 Repeat step 1.
Press the **▲** or **▼** button to select **Edit Name**.
Press the **ENTER**  button.
Result: The options available in the **Edit Name** menu are displayed.

- 5 Select the device that you wish to edit by pressing the **▲** or **▼** button.
Result: The following options are available:
Ext.1 - Ext.2 - AV - S-Video - Component - PC - HDMI

- 6 Press the **ENTER**  button.

- 7 Select the required device by pressing the **▲** or **▼** button repeatedly.
Press the **ENTER**  button.
Result: The following options are available:
---- - VCR - DVD - D-VHS - Cable STB - HD STB - Satellite STB - AV Receiver - DVD Receiver - Game - Camcorder - DVD Combo - DHR - PC

- 8 When you are satisfied with the setting, press the **MENU**  button to return to the previous menu or press the **EXIT** button to return to normal viewing.

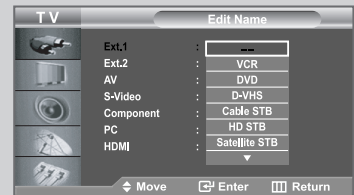
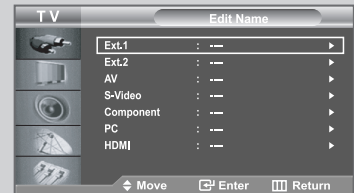
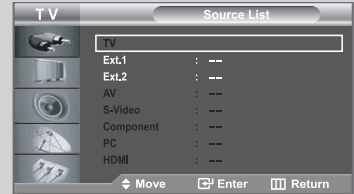

➤ DHR: DVD HDD Recorder

Viewing Pictures from External Sources



Once you have connected up your various audio and video systems, you can view the different sources by selecting the appropriate input.

- 1 Check that all the necessary connections have been made.
 - 2 Press the **SOURCE** button.
Result: The edited device and audio status are displayed on top-left of the set.
 - 3 Press the **SOURCE** button until the required input source is selected.
 - If you change the external source while viewing, pictures might take a short period of time to be switched.
- **TV** mode can be selected by pressing the **TV** or / button on the remote control but you cannot select it by pressing the **SOURCE** button.

Setting up Your PC Software (Based on Windows XP)

The Windows display-settings for a typical computer are shown below. But the actual screens on your PC will probably be different, depending upon your particular version of Windows and your particular video card. But even if your actual screen look different, the same, basic set-up information will apply in almost all cases. (If not, contact your computer manufacturer or Samsung Dealer.)



1 First, click on “Control Panel” on the Windows start menu.

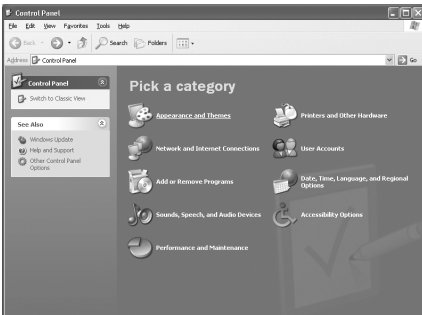

2 When the control panel window appears, click on “Appearance and Themes” and a display dialog-box will appear.

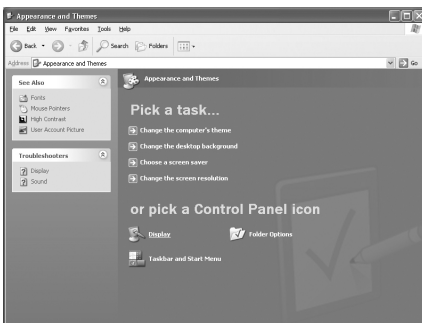

3 When the control panel window appears, click on “Display” and a display dialog-box will appear.



4 Navigate to the “Settings” tab on the display dialog-box.

The correct size setting (resolution)
Optimum- 1360 x 768

If a vertical-frequency option exists on your display settings dialog box, the correct value is “60” or “60 Hz”. Otherwise, just click “OK” and exit the dialog box.

*See “Display Modes” on page 65.

Adjusting the PC Screen Automatically

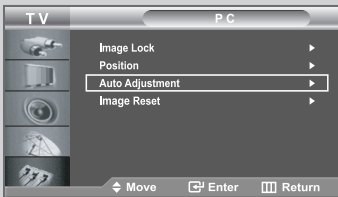
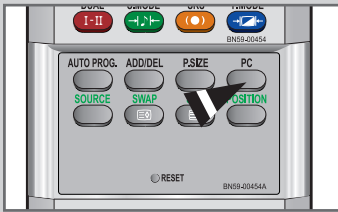

Auto Adjustment in progress.
Please wait.

*Auto adjustment allows the PC screen of set to self-adjust to the incoming PC video signal.
The values of fine, coarse and position are adjusted automatically.*

➤ Press the **PC** button under the remote's cover to select the PC mode.

1 Press the **MENU** button.

Result: The main menu is displayed.

2 Press the **▲** or **▼** button to select **Setup**.
Press the **ENTER** button.

Result: The options available in the **Setup** group are displayed.

3 Press the **▲** or **▼** button to select **PC**.
Press the **ENTER** button.

Result: The options available in the **PC** menu are displayed.

4 Press the **▲** or **▼** button to select **Auto Adjustment**.
Press the **ENTER** button.

Result: The screen quality and position are automatically adjusted.

Coarse and Fine Tuning of the Image

The purpose of picture quality adjustment is to remove or reduce picture noise. If the noise is not removed by Fine-tuning alone, then adjust the frequency as best as possible (coarse) and Fine-tune again. After the noise has been reduced, re-adjust the picture so that it is aligned on the center of screen.

➤ Press the **PC** button under the remote's cover to select the PC mode.

- 1 Press the **MENU** button.
Result: The main menu is displayed.
- 2 Press the **▲** or **▼** button to select **Setup**.
Press the **ENTER** button.
Result: The options available in the **Setup** group are displayed.
- 3 Press the **▲** or **▼** button to select **PC**.
Press the **ENTER** button.
Result: The options available in the **PC** menu are displayed.
- 4 Press the **ENTER** button again.
Result: The **Image Lock** menu is selected.
- 5 Press the **▲** or **▼** button to select **Coarse** or **Fine**.
Press the **ENTER** button.
Result: The horizontal bar is displayed.
- 6 Press the **◀** or **▶** button to adjust the screen quality.
Press the **ENTER** button.
➤ Vertical stripes may appear or the picture may become blurry.
- 7 When you are satisfied with the settings, press the **MENU** button to return to the previous menu or press the **EXIT** button to return to normal viewing.

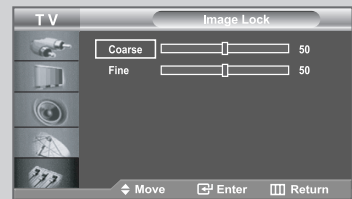
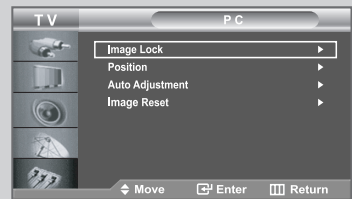
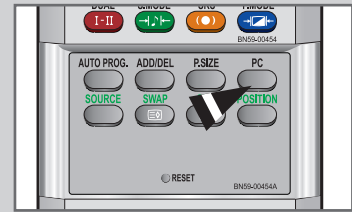

Changing the Image Position

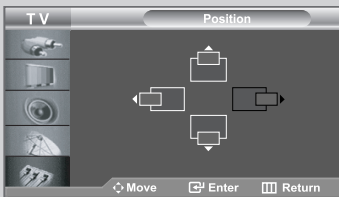
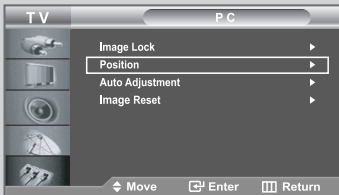

➤ Press the **PC** button under the remote's cover to select the PC mode.

1 Press the **MENU** button.

Result: The main menu is displayed.

2 Press the **▲** or **▼** button to select **Setup**.
Press the **ENTER** button.

Result: The options available in the **Setup** group are displayed.

3 Press the **▲** or **▼** button to select **PC**.
Press the **ENTER** button.

Result: The options available in the **PC** menu are displayed.

4 Press the **▲** or **▼** button to select **Position**.
Press the **ENTER** button.

Result: You can adjust the image **Position**.

5 Press the **◀** or **▶** button to adjust horizontal position.
Press the **▲** or **▼** button to adjust vertical position.
Press the **ENTER** button.

6 Press the **MENU** button to return to the previous menu or press the **EXIT** button to return to normal viewing.

Initializing the Image Settings

You can replace all image settings with the factory default values.

➤ Press the **PC** button under the remote's cover to select the PC mode.

1 Press the **MENU** button.

Result: The main menu is displayed.

2 Press the **▲** or **▼** button to select **Setup**.
Press the **ENTER** button.

Result: The options available in the **Setup** group are displayed.

3 Press the **▲** or **▼** button to select **PC**.
Press the **ENTER** button.

Result: The options available in the **PC** menu are displayed.

4 Press the **▲** or **▼** button to select **Image Reset**.
Press the **ENTER** button.

Result: You can initialize all image setting to the factory default values.

5 Press the **MENU** button to return to the previous menu or press the **EXIT** button to return to normal viewing.

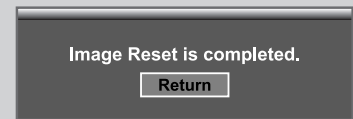
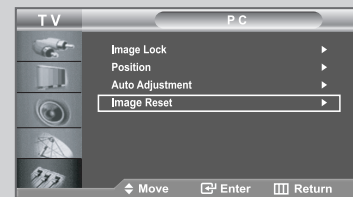
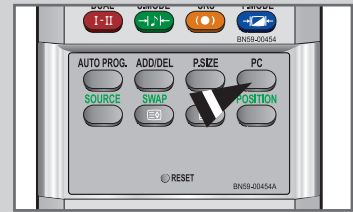

Teletext Decoder

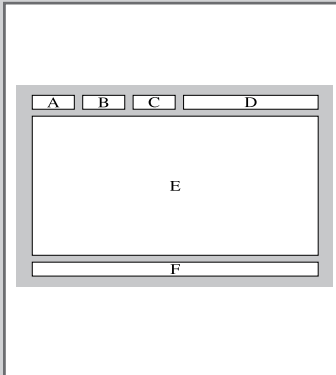

Most set channels carry “ teletext ”, pages of written information that provide information such as:

- ◆ Television programme times.
- ◆ News bulletins and Weather forecasts.
- ◆ Sports results.
- ◆ Subtitles for the hard of hearing.

The teletext pages are organized according to six categories:

Part	Contents
A	Selected page number.
B	Broadcasting station identity.
C	Current page number or search status.
D	Date and time.
E	Text.
F	Status information.

Displaying the Teletext Information



You can display teletext information at any time, but signal reception must be good. Otherwise:

- ◆ Information may be missing.
- ◆ Some pages may not be displayed.

To activate the teletext mode and display the contents page:

- 1 Using the (P) or (M) button, select the channel providing the teletext service.
- 2 Press the **TTX/MIX** (/) button to activate the teletext mode.
Result: The contents page is displayed. It can be redisplayed at any time by pressing the **MENU** () button.
- 3 Press the **TTX/MIX** (/) button again.
Result: The screen will split into two. This Double Teletext feature lets you view the actual broadcast and teletext information separately on the screen.
- 4 Press the **TTX/MIX** (/) button again.
Result: The actual broadcast will be displayed simultaneously with the teletext page on the screen.
- 5 To return to normal viewing, press the **PIP** () button.
- 6 Press the **TV** () button again to exit from the Text display.

- If any broken character appears while Text is being viewed, make sure that the Text language is identical with the language in the “Setup” menu mode. If both languages are different, select the same language with the Text language on the “Setup” menu.

Selecting a Specific Teletext Page

Press the number buttons on the remote control to enter the page number directly:

- 1 Enter the three-digit page number listed in the contents by pressing the corresponding numeric buttons.

Result: The current page counter is incremented and the page is then displayed.

- 2 If the selected page is linked with several secondary pages, the secondary pages are displayed in sequence. To freeze the display on a given page, press the **PRE-CH** (⏮️). Press the **PRE-CH** (⏮️) button again to resume.

- 3 Using the various display options:

To display...	Press the...
◆ Both teletext information and the normal broadcast	TTX/MIX (⏮️/⏭️)
◆ Hidden text (answers to quiz games, for example)	INFO (ℹ️)
◆ The normal screen	INFO (ℹ️) again
◆ A secondary page, by entering its 4-digit number	SLEEP (⏸️)
◆ The next page	Page Up (⏮️)
◆ The previous page	Page Down (⏭️)
◆ Double-size letters in the: <ul style="list-style-type: none"> • Upper half of the screen • Lower half of the screen 	SIZE (⏮️) •Once •Twice
◆ Normal screen	•Three times



Using Fastext to Select a Teletext Page



The various topics included in the teletext pages are colour-coded, and can be selected by pressing the coloured buttons on the remote control.

- 1 Display the teletext contents page by pressing the **TTX/MIX** (≡/☒) button.
- 2 Press the coloured button corresponding to the topic that you wish to select (The available topics are listed on the status information line).



Result: The page is displayed with additional colour-coded information that can be selected in the same way.

- 3

To display the:	Press the:
Previous page	Red button.
Next page	Green button.
- 4 When you have finished, press the **PIP** (☒) button to return to the normal broadcast.

Troubleshooting: Before Contacting Service Personnel

Before contacting Samsung after-sales service, perform the following simple checks. If you cannot solve the problem using the instructions below, note the model and serial number of your set and contact your local dealer.

No sound or picture	<ul style="list-style-type: none"> ◆ Check that the mains lead has been connected to a wall socket. ◆ Check that you have pressed the POWER  buttons on the lower-right panel. ◆ Check the picture contrast and brightness settings. ◆ Check the volume.
Normal picture but no sound	<ul style="list-style-type: none"> ◆ Check the volume. ◆ Check whether the MUTE  button has been pressed on the remote control. ◆ Check if Internal Mute is off
No picture or black and white picture	<ul style="list-style-type: none"> ◆ Adjust the colour settings. ◆ Check that the broadcast system selected is correct.
Sound and picture interference	<ul style="list-style-type: none"> ◆ Try to identify the electrical appliance that is affecting the set and move it further away. ◆ Plug your set into a different mains socket.
Blurred or snowy picture, distorted sound	<ul style="list-style-type: none"> ◆ Check the direction, location and connections of your aerial. This interference is often due to the use of an indoor aerial.
Remote control malfunctions	<ul style="list-style-type: none"> ◆ Replace the remote control batteries. ◆ Clean the upper edge of the remote control (transmission window). ◆ Check the battery terminals.
"Check signal cable." message is displayed.	<ul style="list-style-type: none"> ◆ Check that the signal cable is firmly connected to the PC or video sources. ◆ Check that the PC or video sources are turned on.
On PC mode, "Not Supported Mode." message is displayed.	<ul style="list-style-type: none"> ◆ Check the maximum resolution and the frequency of the video adapter. ◆ Compare these values with the data in the Display Modes.
The image is too light or too dark.	<ul style="list-style-type: none"> ◆ Adjust the Brightness and Contrast.
On PC mode, horizontal bars appear to flicker, jitter or shimmer on the image.	<ul style="list-style-type: none"> ◆ Adjust the Fine function.
On PC mode, vertical bars appear to flicker, jitter or shimmer on the image.	<ul style="list-style-type: none"> ◆ Adjust the Coarse function and then adjust the Fine function.
On PC mode, screen is black and power indicator light blinks every 1 second.	<ul style="list-style-type: none"> ◆ The TV is using its power management system. ◆ Move the computer's mouse or press any key on the keyboard.
On PC mode, image is not stable and may appear to vibrate.	<ul style="list-style-type: none"> ◆ Check that the display resolution and frequency from your computer or video board is an available mode for your set. On your computer check: Control Panel, Display, Settings. ◆ If the setting is not correct, use your computer utility programme to change the display settings. <p>➤ Your set supports multiscan display functions within the following frequency domain:</p> <p>Horizontal frequency(kHz): 30~ 61 Vertical frequency(Hz): 60~75 Maximum refresh rate (at 60Hz): 1360 X 768</p>
On PC mode, image is not centered on the screen.	<ul style="list-style-type: none"> ◆ Adjust the horizontal and vertical position.

The TFT LCD panel uses a panel consisting of sub pixels (3,147,264) which require sophisticated technology to produce. However, there may be few bright or dark pixels on the screen. These pixels will have no impact on the performance of the product.

Installing the Wall Mount Kit (LE26M5)

➤ *This installation is to be used when attaching the wall mount to a concrete wall. When attaching to other building materials, please contact your nearest dealer.*

Components (Sold separately)

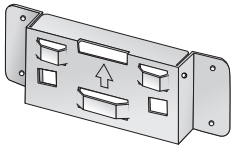

a Wall-Bracket

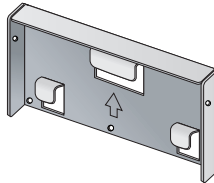

b Set-Bracket



M4 X L15

c Screw: 8EA



M4 X L20

d Wood Screw: 4EA

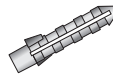

e Anchor: 4EA

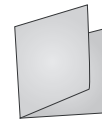

f Installation Guide

How to assemble the Wall Mount Bracket

- 1 ① Mark the location of hole on the wall.
- 2 ② Drill a hole of 35mm depth on the marked location.
- 3 ③ Fix anchors **e** on each hole on the wall.
- 4 ④ Connect wall-bracket **a** to the wall with wood screws **d** after fitting anchors **e** into the wall-bracket **a**.

Note: If the bracket is not firmly fixed to the wall, LCD TV can fall off.

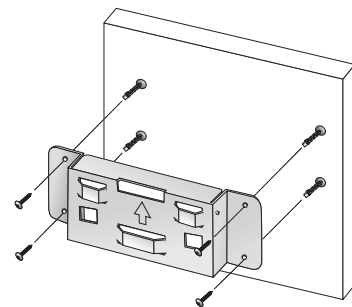

Installing the Wall Mount Kit (LE26M5)

How to assemble the Wall Mount Bracket

- 2 ① Turn the power off and unplug the power cord from the outlet.
- ② Place the TV faced down on a soft cloth or cushion on a table.
- ③ Remove the four screws from the back of the TV.
- ④ Separate the stand from the TV.
- ⑤ Cover the bottom hole with a cap.
- ⑥ Attach the set-bracket ① onto the rear side of the TV set and secure the screws ②.

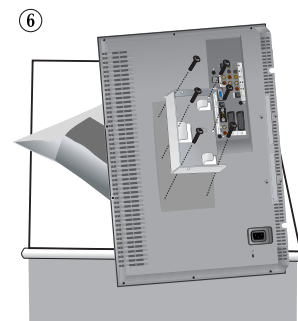
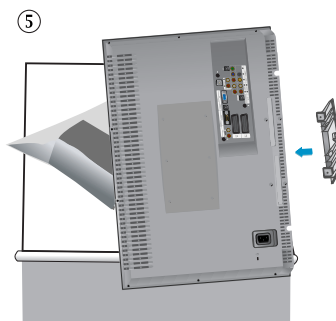
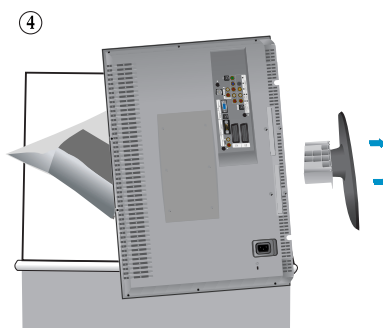
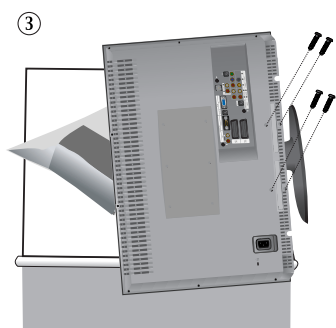

- 3 ① Insert three Hangers of the set-bracket ① into the grooves of the wall-bracket ②.
- ② Fix set-bracket ① and wall-bracket ② with screws ③.

Note: Before installing the set on the wall, connect the cables to the set first.

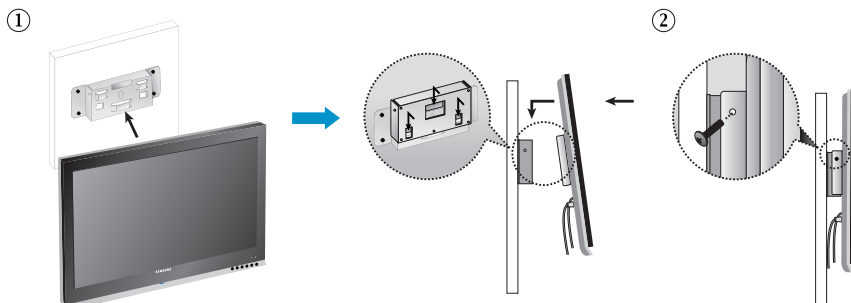

Installing the Wall Mount Kit (LE32M5, LE40M5, LE46M5)

➤ *This installation is to be used when attaching the wall mount to a concrete wall. When attaching to other building materials, please contact your nearest dealer.*

Components (Sold separately)

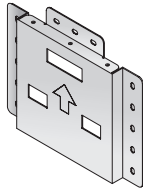

a Wall-Bracket

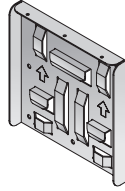

b Set-Bracket



M6 X L14

c Screw: 8EA



M4 X L25

d Wood Screw: 7EA

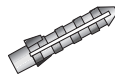

e Anchor: 7EA



M4 X L8

f Screw: 3EA

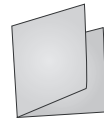

g Installation Guide

How to assemble the Wall Mount Bracket

- 1 ① Mark the location of hole on the wall.
- 2 ② Drill a hole of 35mm depth on the marked location.
- 3 ③ Fix anchors **e** on each hole on the wall.
- 4 ④ Connect wall-bracket **a** to the wall with wood screws **d** after fitting anchors **e** into the wall-bracket **a**.

Note: If the bracket is not firmly fixed to the wall, LCD TV can fall off.

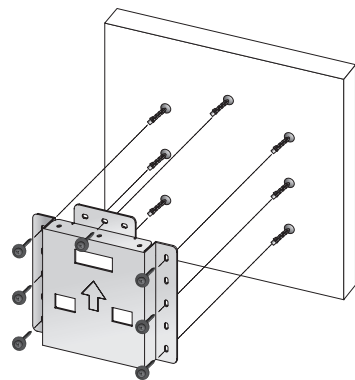

Installing the Wall Mount Kit (LE32M5, LE40M5, LE46M5)

How to assemble the Wall Mount Bracket

- 2 ① Turn the power off and unplug the power cord from the outlet.
- ② Place the TV faced down on a soft cloth or cushion on a table.
- ③ Remove the four screws from the back of the TV.
- ④ Separate the stand from the TV.
- ⑤ Cover the bottom hole with a cap
- ⑥ Loosen two screws on the rear side of the TV set (only model LE40M5 applied).
- ⑦ Attach the set-bracket **b** onto the rear side of the TV set and secure the screws **c**.
For 40 inches model, attach the bracket into the two holes with the two screws removed in step 6 above.

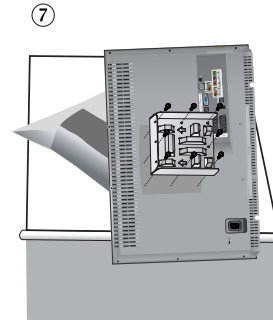
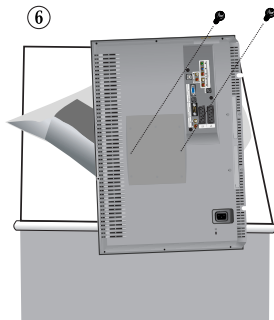
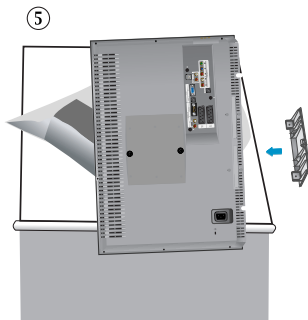
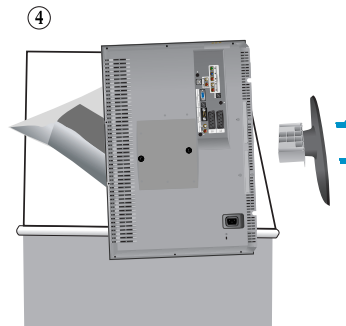
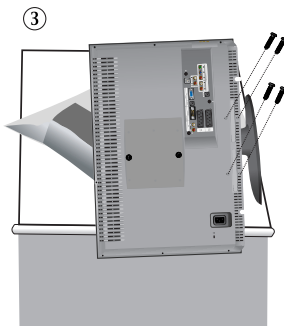

(Only Model LE40M5 Applied)

- 3 ① Insert three Hangers of the set-bracket **b** into the grooves of the wall-bracket **a**.
- ② Fix set-bracket **b** and wall-bracket **a** with screws **f**.

Note: Before installing the set on the wall, connect the cables to the set first.

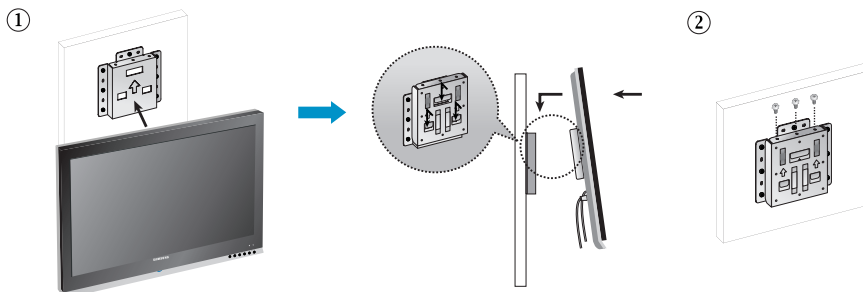

Installing the Stand (LE26M5, LE32M5)

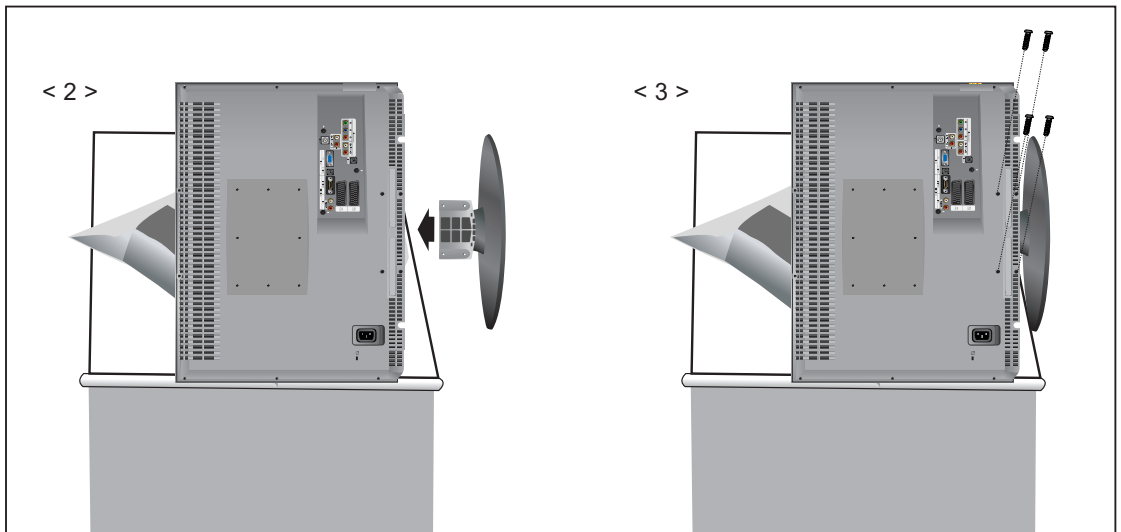

1. Place the TV faced down on a soft cloth or cushion on a table.
2. Attach the stand to the TV set as shown in the picture.
3. Use the four screws to tightly fix the stand.

Using the Anti-Theft Kensington Lock

The Kensington lock is a device used to physically fix the system when using it in a public place. The locking device has to be purchased separately. The appearance and locking method may differ from the illustration depending on the manufacturer. Please refer to the manual provided with the Kensington lock for proper use.

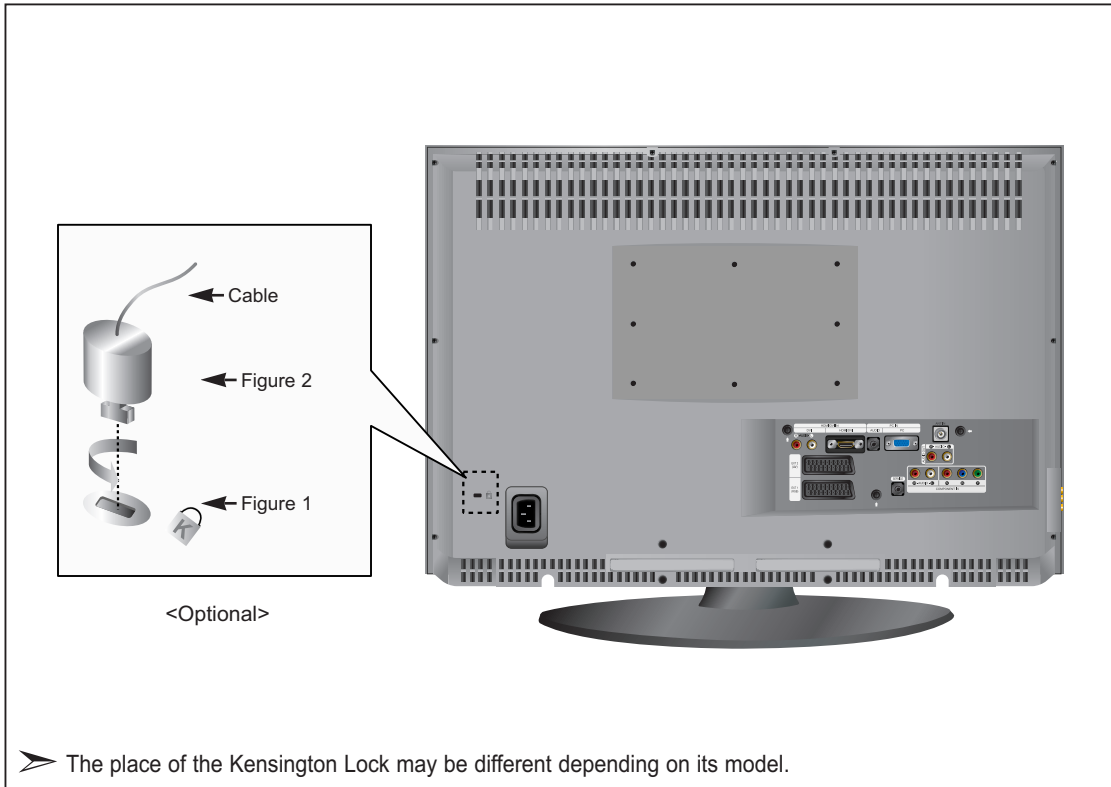

1. Insert the locking device into the Kensington slot on the LCD TV (Figure 1), and turn it in the locking direction (Figure 2).
2. Connect the Kensington lock cable.
3. Fix the Kensington lock to a desk or a heavy stationary object.

Technical and Environmental Specifications

Model Name	LE26M5	LE32M5	LE40M5	LE46M5
Panel				
Size	26" Diagonal (16:9)	32" Diagonal (16:9)	40" Diagonal (16:9)	46" Diagonal (16:9)
Display Size	575.77(H) x 323.71(V) mm (22.67(H) x 12.74(V) inches)	697.68 (H) x 392.26 (V) mm (27.47 (H) x 15.44 (V) inches)	885.17(H) x 497.66(V) mm (34.85(H) x 19.59(V) inches)	1018.35(H) x 572.54(V) mm (40.09(H) x 22.54(V) inches)
Type	a-si TFT active matrix	a-si TFT active matrix	a-si TFT active matrix	a-si TFT active matrix
Pixel Pitch	0.4215(H) x 0.4215(V) mm (0.0166(H) x 0.0166(V) inches)	0.511 (H) x 0.511 (V) mm (0.0201 (H) x 0.0201(V) inches)	0.648(H) x 0.216(V) mm (0.027(H) x 0.0085(V) inches)	0.2485(H) x 0.7455(V) mm (0.0098(H) x 0.029(V) inches)
Viewing Angle	170/170 (H/V)	170/170 (H/V)	170/170(H/V)	170/170 (H/V)
Resolution	1366(H) x 768(V)	1366 (H) x 768 (V)	1366(H) x 768(V)	1366 (H) x 768 (V)
Frequency				
Horizontal	30 ~ 61 kHz	30 ~ 61 kHz	30 ~ 61 kHz	30 ~ 61 kHz
Vertical	60 ~ 75 Hz	60 ~ 75 Hz	60 ~ 75 Hz	60 ~ 75 Hz
Display Colour	16,777,216 colours	16,777,216 colours	16,777,216 colours	16,777,216 colours
PC Resolution				
Maximum	1360 x 768 @ 60 Hz	1360 x 768 @ 60Hz	1360 x 768 @ 60Hz	1360 x 768 @ 60Hz
Optimum	1360 x 768 @ 60 Hz	1360 x 768 @ 60 Hz	1360 x 768 @ 60 Hz	1360 x 768 @ 60 Hz
Input Signal				
Sync.	H/V Separate, TTL, P. or N.	H/V Separate, TTL, P. or N.	H/V Separate, TTL, P. or N.	H/V Separate, TTL, P. or N.
Video Signal	0.7 Vp-p @ 75 ohm	0.7 Vp-p @ 75 ohm	0.7 Vp-p @ 75 ohm	0.7 Vp-p @ 75 ohm
TV				
Colour System	PAL, SECAM-B/G, D/K, I, I/I, L/L', NTPB (AV3.58, 4.43)	PAL, SECAM-B/G, D/K, I, I/I, L/L', NTPB (AV3.58, 4.43)	PAL, SECAM-B/G, D/K, I, I/I, L/L', NTPB (AV3.58, 4.43)	PAL, SECAM-B/G, D/K, I, I/I, L/L', NTPB (AV3.58, 4.43)
Sound System	BG, DK, I, L	BG, DK, I, L	BG, DK, I, L	BG, DK, I, L
Video				
Colour System	PAL/NTSC/SECAM	PAL/NTSC/SECAM	PAL/NTSC/SECAM	PAL/NTSC/SECAM
Video System	CVBS, S-VHS, RGB	CVBS, S-VHS, RGB	CVBS, S-VHS, RGB	CVBS, S-VHS, RGB
SCART 1				
Video Input/Output	1.0 Vp-p @ 75 ohm	1.0 Vp-p @ 75 ohm	1.0 Vp-p @ 75 ohm	1.0 Vp-p @ 75 ohm
RGB Input	0.7 Vp-p @ 75 ohm	0.7 Vp-p @ 75 ohm	0.7 Vp-p @ 75 ohm	0.7 Vp-p @ 75 ohm
Audio Input/Output	500mVrms	500mVrms	500mVrms	500mVrms
SCART 2				
Video Input/Output	1.0 Vp-p @ 75 ohm	1.0 Vp-p @ 75 ohm	1.0 Vp-p @ 75 ohm	1.0 Vp-p @ 75 ohm
Audio Input/Output	500mVrms	500mVrms	500mVrms	500mVrms
Power Supply				
Input	AC 220 ~ 240 V, 60/50 Hz ±3Hz	AC 220 ~ 240 V, 60/50 Hz ±3Hz	AC 220 ~ 240 V, 60/50 Hz ±3Hz	AC 220 ~ 240 V, 60/50 Hz ±3Hz
Power Consumption				
Normal	140 W	170 W	275 W	275 W
Power Saving	<1.5 W	<1.5 W	<1.5 W	<1.5 W
Dimension (W x D x H)				
Body	678 x 111 x 476 mm (26.69 x 4.37 x 18.74 inches)	804 x 113 x 564 mm (31.65 x 4.45 x 22.20 inches)	1004 x 115 x 680 mm (39.52 x 4.52 x 26.77 inches)	1126 x 140 x 752 mm (44.33 x 5.51 x 29.60 inches)
With stand	678 x 226 x 532 mm (26.69 x 8.90 x 20.94 inches)	804 x 250 x 622.5 mm (31.65 x 9.84 x 24.50 inches)	1004 x 330 x 749 mm (39.52 x 12.99 x 29.49 inches)	1126 x 360 x 820 mm (44.33 x 14.17 x 32.28 inches)

Technical and Environmental Specifications

Model	LE26M5	LE32M5	LE40M5	LE46M5
Weight With stand	13.3 kg (29.32 lbs)	19.2 kg (42.33 lbs)	27.5 kg (60.63 lbs)	37 kg (81.57 lbs)
Environmental Considerations				
Operating Temperature	10°C to 40°C (50°F to 104°F)	10°C to 40°C (50°F to 104°F)	10°C to 40°C (50°F to 104°F)	10°C to 40°C (50°F to 104°F)
Operating Humidity	10% to 80%, non-condensing	10% to 80%, non-condensing	10% to 80%, non-condensing	10% to 80%, non-condensing
Storage Temperature	-20°C to 45°C (-4°F to 113°F)	-20°C to 45°C (-4°F to 113°F)	-20°C to 45°C (-4°F to 113°F)	-20°C to 45°C (-4°F to 113°F)
Storage Humidity	5% to 95%, non-condensing	5% to 95%, non-condensing	5% to 95%, non-condensing	5% to 95%, non-condensing
Audio Characteristics				
Audio Input	RCA Jack (L, R), 0.5 Vrms (-9dB)	RCA Jack (L, R), 0.5Vrms (-9dB)	RCA Jack (L, R), 0.5Vrms (-9dB)	RCA Jack (L, R), 0.5Vrms (-9dB)
Audio Input (PC)	3.5Ø Stereo Jack, 0.5Vrms (-9dB)	3.5Ø Stereo Jack, 0.5Vrms (-9dB)	3.5Ø Stereo Jack, 0.5Vrms (-9dB)	3.5Ø Stereo Jack, 0.5Vrms (-9dB)
Headphone Output	Max. 10mW Output (3.5Ø Stereo Jack, 32Ω)	Max. 10mW Output (3.5Ø Stereo Jack, 32Ω)	Max. 10mW Output (3.5Ø Stereo Jack, 32Ω)	Max. 10mW Output (3.5Ø Stereo Jack, 32Ω)
Frequency	RF: 80Hz ~ 15kHz (at -3dB)	RF: 80Hz ~ 15kHz (at -3dB)	RF: 80Hz ~ 15kHz (at -3dB)	RF: 80Hz ~ 15kHz (at -3dB)
Response	A/V: 80Hz ~ 20kHz (at -3dB)	A/V: 80Hz ~ 20kHz (at -3dB)	A/V: 80Hz ~ 20kHz (at -3dB)	A/V: 80Hz ~ 20kHz (at -3dB)
Sound				
Output	5 W X 2	10 W X 2	10 W X 2	10 W X 2
3D Surround	SRS TruSurroundXT	SRS TruSurroundXT	SRS TruSurroundXT	Virtual dolby
Stereo	Nicam/A7	Nicam/A3	Nicam/A2	Nicam/A2

Display Mode (PC)

*Both screen position and size will vary depending on the type of PC monitor and its resolution.
The table below shows all of the display modes that are supported:*

Mode	Resolution	Horizontal Frequency (kHz)	Vertical Frequency (Hz)	Pixel Clock Frequency (MHz)	Sync Polarity (H/V)
IBM	640 x 480	31.469	59.940	25.175	- / -
	720 x 400	31.469	70.087	28.322	- / +
VESA	640 x 480	37.861	72.809	31.500	- / -
	640 x 480	37.500	75.000	31.500	- / -
	800 x 600	37.879	60.317	40.000	+ / +
	800 x 600	48.077	72.188	50.000	+ / +
	800 x 600	46.875	75.000	49.500	+ / +
	1024 x 768	48.364	60.000	65.000	- / -
	1024 x 768	56.476	70.069	75.000	- / -
	1024 x 768	60.023	75.029	78.750	+ / +
	1360 x 768	47.712	60.015	85.800	+ / +

- ◆ The interlace mode is not supported.
- ◆ The set might operate abnormally if a non-standard video format is selected.
- ◆ DVI dose not support PC function.

Pin Configurations

SCART Connector

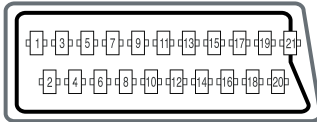

Pin	Signal	Pin	Signal
1	Audio output R	12	-
2	Audio input R	13	Video chassis return (RGB red)
3	Audio output L	14	-
4	Audio chassis return	15	RGB red input
5	Video chassis return (RGB blue)	16	Blanking signal (RGB switching)
6	Audio input L	17	Video chassis return
7	RGB blue input	18	Blanking signal ground
8	Switching voltage	19	Video output
9	Video chassis return (RGB green)	20	Video input
10	AV-Link (Ext 1)	21	Screening/chassis return
11	RGB green input		

PC Input Connector (15Pin)

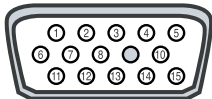

Pin	Signal	Pin	Signal
1	Red (R)	9	Reserved
2	Green (G)	10	Sync Grounding
3	Blue (B)	11	Grounding
4	Grounding	12	Data (DDC)
5	Grounding (DDC)	13	Horizontal sync.
6	Red (R) Grounding	14	Vertical sync.
7	Green (G) Grounding	15	Clock (DDC)
8	Blue (B) Grounding		

Warning! Important Safety Instructions

Please read the appropriate section that corresponds to the marking on your Samsung product before attempting to install the product.

CAUTION

RISK OF ELECTRIC SHOCK DO NOT OPEN

CAUTION: TO REDUCE THE RISK OF ELECTRIC SHOCK, DO NOT REMOVE COVER (OR BACK). THERE ARE NO USER SERVICEABLE PARTS INSIDE. REFER ALL SERVICING TO QUALIFIED PERSONNEL.



This symbol indicates that high voltage is present inside. It is dangerous to make any kind of contact with any internal part of this product.



This symbol alerts you that important literature concerning operation and maintenance has been included with this product.

- The slots and openings in the cabinet and in the back or bottom are provided for necessary ventilation. To ensure reliable operation of this apparatus, and to protect it from overheating, these slots and openings must never be blocked or covered.
 - Do not cover the slots and openings with a cloth or other materials.
 - Do not block the slots and openings by placing this apparatus on a bed, sofa, rug or other similar surface.
 - Do not place this apparatus in a confined space, such as a bookcase, or built-in cabinet, unless proper ventilation is provided.
- Do not place this apparatus near or over a radiator or heat register, or where it is exposed to direct sunlight.
- Do not place sources of heat on this apparatus, such as a candles, ash trays, incense or other similar items.
- Do not place a water containing vessel on this apparatus, as this can result in a risk of fire or electric shock.
- Do not expose this apparatus to rain or place it near water (near a bathtub, washbowl, kitchen sink, or laundry tub, in a wet basement, or near a swimming pool etc.).

If this apparatus accidentally gets wet, unplug it and contact an authorized dealer immediately.

You can clean this apparatus with damp cloth when necessary, but be sure to unplug the apparatus first.
- Do not expose this apparatus to extreme temperature conditions or to extreme humidity conditions.
- This apparatus uses batteries. In your community there might be regulations that require you to dispose of these batteries properly under environmental considerations. Please contact your local authorities for disposal or recycling information.
- To cut off the power source, unplug this apparatus from the wall outlet.
- Do not overload wall outlets, extension cords or adaptors beyond their capacity, since this can result in fire or electric shock.
- Power-supply cords should be routed so that they are not likely to be walked on or pinched by items placed upon or against them, paying particular attention to cords at plug end, adaptors and the point where they exit from the appliance.
- To protect this apparatus from a lightning storm, or when it is left unattended and unused for long periods of time, unplug it from the wall outlet and disconnect the antenna or cable system.

This will prevent damage to the set due to lightning and power line surges.
- Before connecting the AC power cord to the DC adapter outlet, make sure the voltage designation of the DC adaptor corresponds to the local electrical supply.
- Never insert anything metallic into the open parts of this apparatus. Doing so may create a danger of electric shock.
- To avoid electric shock, never touch the inside of this apparatus. Only a qualified technician should open this apparatus.
- Be sure to hold the plug, not the cord, when disconnecting this apparatus from an electric socket.
- Locate this apparatus near an easily accessible AC outlet.
- If this apparatus does not operate normally - in particular, if there are any unusual sounds or smells coming from it
 - unplug it immediately and contact an authorized dealer or service center.
- Unplug this apparatus from the AC outlet before any service.
- Be sure to pull the power plug out of the outlet if the TV is to remain unused or if you are to leave the house for an extended period of time (especially when children, elderly or disabled people will be left alone in the house).
 - Accumulated dust can cause an electric shock, an electric leakage or a fire by causing the power cord to generate sparks and heat or the insulation to deteriorate.
- Be sure to contact an authorized service center, when installing your set in a location with heavy dust, high or low temperatures, high humidity, chemical substances and where it operates for 24 hours such as the airport, the train station etc. Failure to do so may cause serious damage to your set.

Wiring the Mains Power Supply Plug(UK Only)

IMPORTANT NOTICE

The mains lead on this equipment is supplied with a moulded plug incorporating a fuse. The value of the fuse is indicated on the pin face of the plug and, if it requires replacing, a fuse approved to BSI1362 of the same rating must be used.

Never use the plug with the fuse cover omitted if the cover is detachable. If a replacement fuse cover is required, it must be of the same colour as the pin face of the plug. Replacement covers are available from your dealer.

If the fitted plug is not suitable for the power points in your house or the cable is not long enough to reach a power point, you should obtain a suitable safety approved extension lead or consult your dealer for assistance. However, if there is no alternative but to cut off the plug, remove the fuse and then safely dispose of the plug. Do NOT connect the plug to a mains socket as there is a risk of shock hazard from the bared flexible cord.

IMPORTANT

The wires in the mains lead are coloured in accordance with the following code:

BLUE - NEUTRAL BROWN - LIVE

As these colours may not correspond to the coloured markings identifying the terminals in your plug, proceed as follows :

The wire coloured BLUE must be connected to the terminal marked with the letter N or coloured BLUE or BLACK.

The wire coloured BROWN must be connected to the terminal marked with the letter L or coloured BROWN or RED.

WARNING:

DO NOT CONNECT EITHER WIRE TO THE EARTH TERMINAL, WHICH IS MARKED WITH THE LETTER E OR BY THE EARTH SYMBOL (⊕), OR COLOURED GREEN OR GREEN AND YELLOW.

Warranty Card



UNITED KINGDOM

This Samsung product is warranted for a period of twelve (12) months from the original date of purchase, against defective materials and workmanship. In the event that warranty service is required, you should return the product to the retailer from whom it was purchased.

However, Samsung Authorised Dealers and Authorised Service Centres in other EC Countries will comply with the warranty on the terms issued to purchasers in the country concerned. In case of difficulty, details of our Authorised Service Centres are available from:

**Samsung Electronics (U.K.) Ltd.,
Unit C, Customer Care Centre, Stafford Park 12,
TELFORD, Shropshire TF3 3BJ,
Tel: 0870) 242 0303, Fax: 01952) 297617**

WARRANTY CONDITIONS

1. The warranty is only valid if, when warranty service is required, the warranty card is fully and properly completed and is presented with the original invoice or sales slip or confirmation, and the serial number on the product has not been defaced.
2. Samsung's obligations are limited to the repair or, at its discretion, replacement of the product or the defective part.
3. Warranty repairs must be carried out by Authorised Samsung Dealers or Authorised Service Centres. No re-imburement will be made for repairs carried out by non Samsung Dealers and, any such repair work and damage to the products caused by such repair work will not be covered by this warranty.
4. This product is not considered to be defective in materials nor workmanship by reason that it requires adaptation in order to conform to national or local technical or safety standards in force in any Country other than the one for which the product was originally designed and manufactured.