

CUSTOMER : _____.

DATE : JAN 09, 2013 .

REV : REV. 0.0 .

PRODUCT FAMILY DATA SHEET



6030 2Cup 2Chip (3500K)

MODEL NAME : LEMWS68T80KZ◇◇◇◇



CONTENTS

1. Features	-----	3
2. Applications	-----	3
3. Outline Dimensions	-----	3
4. Absolute Maximum Ratings	-----	4
5. Electro-Optical Characteristics	-----	4
6. Typical Characteristic Curves	-----	5 ~ 6
7. Reliability Test Items and Conditions	-----	7
8. Packing of Products	-----	8
9. Cautions on Use	-----	9 ~ 12

1. Features

- Lighting Color : White
- Lead Frame Type LED Package : 6.0×3.0×0.8 mm (L×W×H)
- Viewing Angle : 118°
- Chip Material : InGaN
- Soldering Method : Reflow Soldering
- Taping : 12 mm conductive black carrier tape & antistatic clear cover tape.

4,000pcs/reel, Φ178mm Reel

- UL-recognized Component (E356829)
- RoHS Compliant

2. Applications

- Interior and Exterior Illumination

3. Outline Dimensions

(Unit : mm)

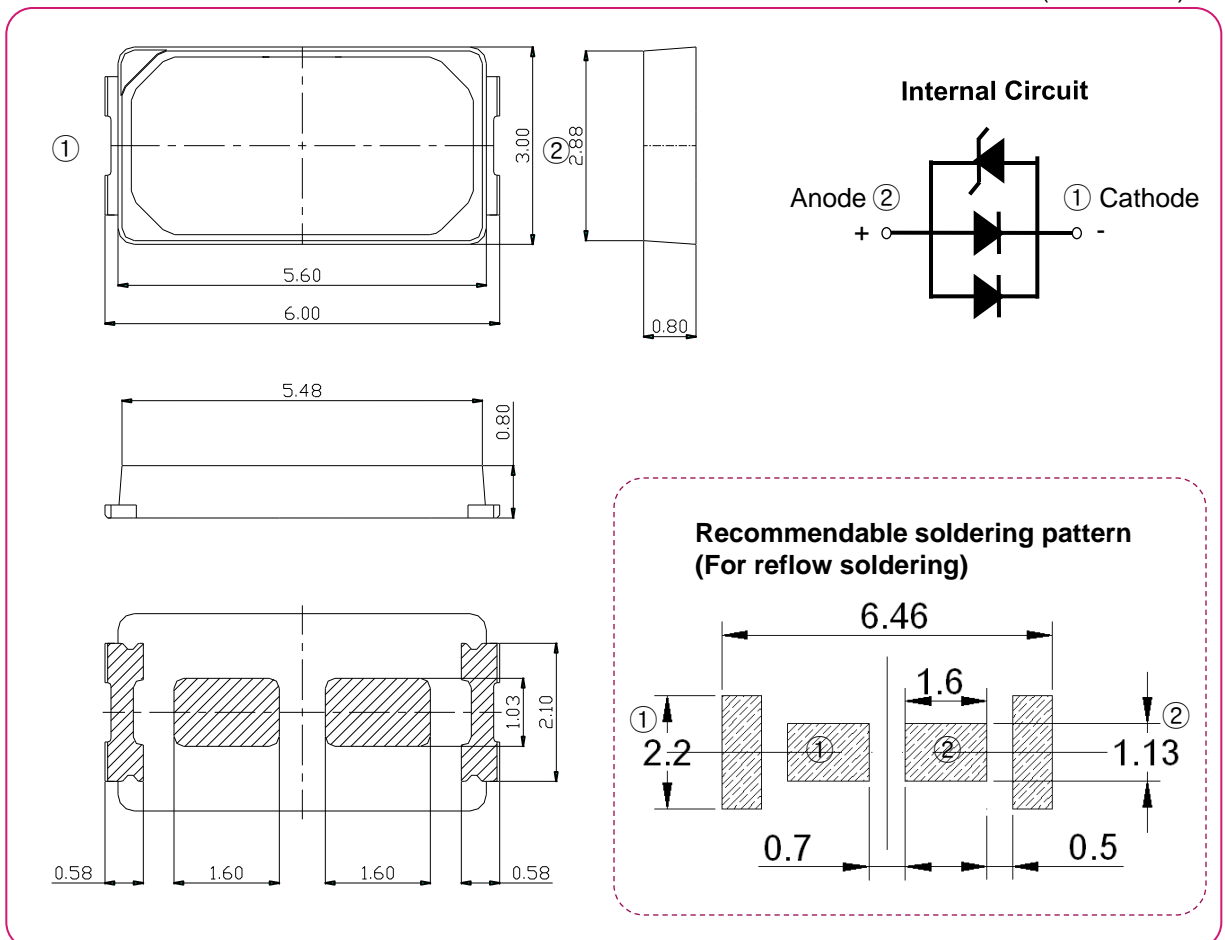

▪ Tolerances unless otherwise specified is ± 0.1 mm

4. Absolute Maximum Ratings

(Ta=25℃)

Item	Symbol	Rating	Unit
Forward Current	If	240	mA
Peak Pulse Forward Current*1)	I _{fp}	270	mA
Operating Temperature	T _{opr}	-30 ~ +85	℃
Storage Temperature	T _{stg}	-40 ~ +100	℃
Junction Temperature	T _j	110	℃
Soldering Temperature	JEDEC-J-STD-020D		
ESD Classification	Class 2 (JESD22-A114)		

*1) Pulse width = 10 ms, duty ≤ 10%

※ Operating the LED beyond the listed under maximum ratings may cause permanent damages to the device.

These or any other conditions beyond those indicated under recommended operating conditions are not implied.

The exposure to the absolute maximum rated conditions may affect device reliability.

※ LEDs are not designed to be driven in reverse voltage.

5. Electro - Optical Characteristics

(Ta=25℃)

Item	Symbol	Condition	Min.	Typ.	Max.	Unit
Forward Voltage	V _f	I _f =130 [mA]	2.80	-	3.20	V
Luminous Flux	Φ _v	I _f =130 [mA]	45.8	-	59.5	lm
Color	C _x / C _y	I _f =130 [mA]	Refer to 'Order Code'			-
Viewing Angle	2Θ1/2	I _f =130 [mA]	-	118	-	deg
Color Rendering Index (Ra)	-	I _f =130 [mA]	80	-	-	-
Thermal Resistance, Junction to Solder Point	R _{th j-s}	I _f =130 [mA]	-	12	-	℃/W
Typical Temperature Coefficient of Forward Voltage*1)	ΔV _f / ΔT _j	I _f =130 [mA]	-1.0	-	-3.0	mV/℃

*1) Measured between Ta = 25℃ and 150℃ at I_f=130mA

I _f (mA)	V _f (V)	Power (W)	Φ _v (lm)	lm/W
70	2.87	0.200	29.1	145
90	2.92	0.262	36.8	140
110	2.96	0.325	44.3	136
130 (Typ.)	3.00	0.390	51.5	132
150	3.04	0.456	58.6	128
180	3.09	0.556	68.9	123
200	3.13	0.626	75.5	120
240	3.18	0.763	88.6	116

※ Φ_v values are for representative references only.

※ These values are measured by the LG Innotek optical spectrum analyzer within the following tolerances.

Luminous Flux (Φ_v) : ±7%, Forward Voltage (V_f) : ±0.1V, Color Value : ±0.005, CRI Value : ±2, Viewing Angle : ±5°

6. Typical Characteristic Curves

▪ Forward Current vs. Forward Voltage

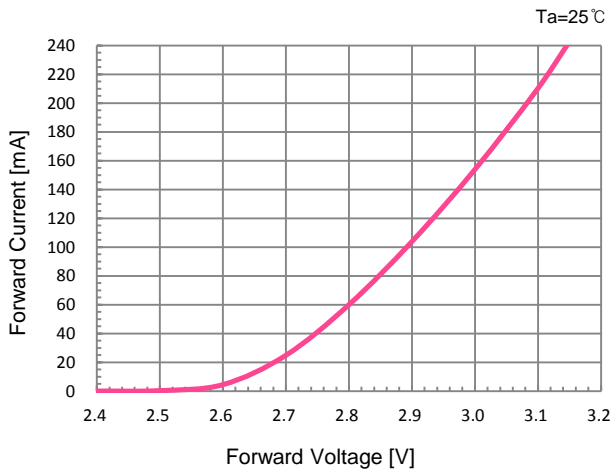

▪ Relative Luminous Flux vs. Forward Current

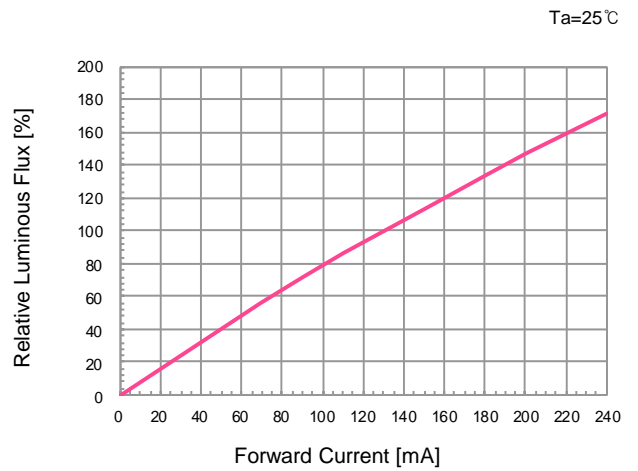

▪ Spectrum

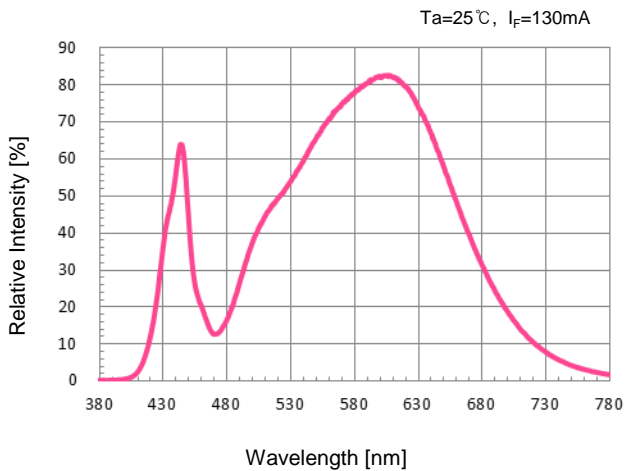

▪ Chromaticity Coordinate vs. Forward Current

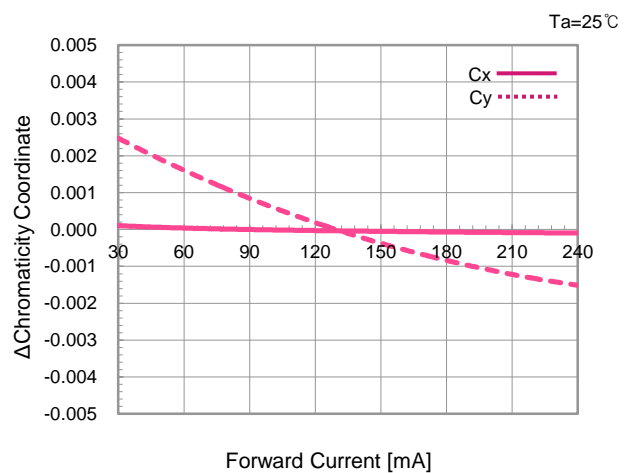

▪ Radiation Characteristics

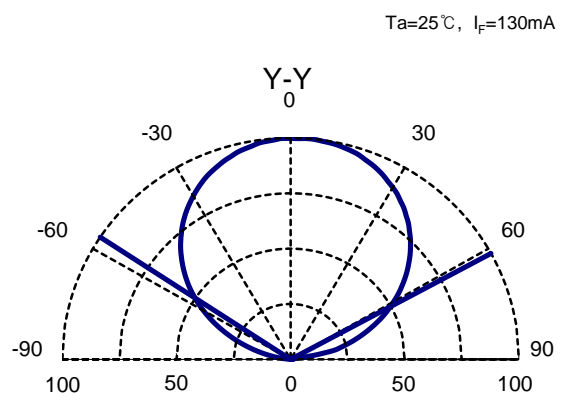
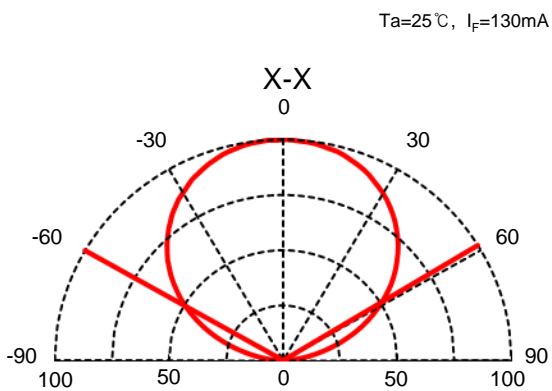

6. Typical Characteristic Curves

▪ Luminous Flux vs. Temperature

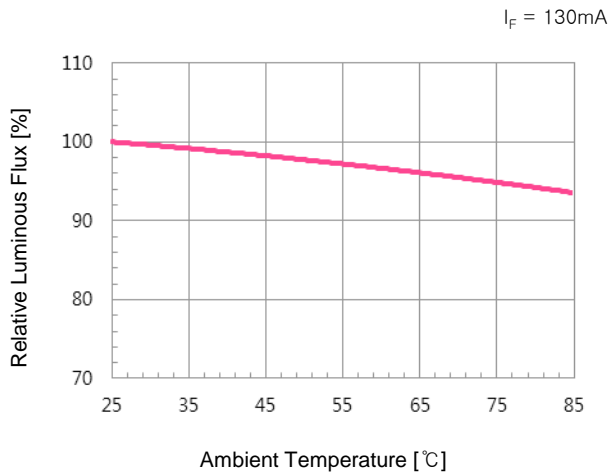

▪ Chromaticity Coordinate vs. Temperature

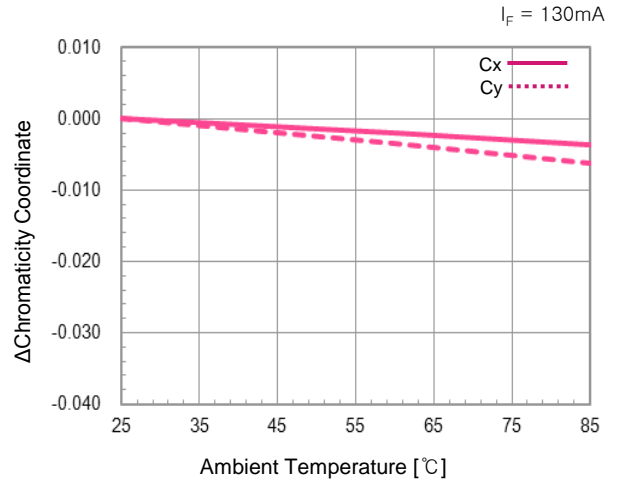

▪ Forward Voltage vs. Temperature

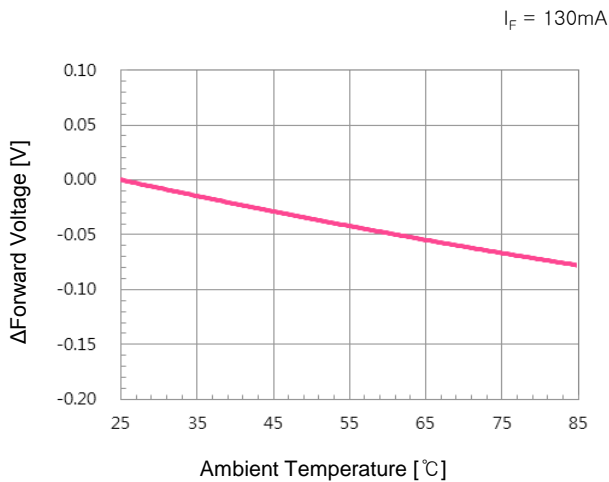

▪ Derating Curve

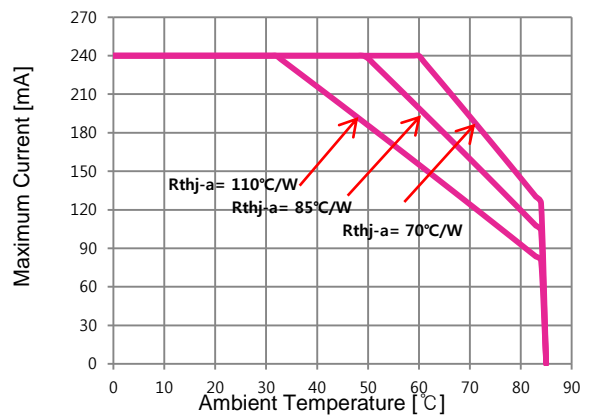

※ The ambient temperatures for each graph are based on the LG Innotek equipments.

7. Reliability Test Items and Conditions

7-1. Criteria for Judging Damages

Items	Symbols	Test Conditions	Limits	
			Min.	Max.
Forward Voltage	V _f	I _f = 180mA	-	Initial Value × 1.1
Luminous Flux	Φ _v	I _f = 180mA	Initial Value × 0.7	-

7-2. Reliability Test

No	Items	Test Conditions	Test Hours /Cycles
1	Room Temperature Operating Life (RTOL)	T _a =25℃, I _f =180mA	1,000 hours
2	Wet High Temperature Operating Life (WHTOL)	T _a =60℃, RH=90%, I _f =180mA	1,000 hours
3	High Temperature Operating Life (HTOL)	T _a =85℃, I _f =180mA	1,000 hours
4	Low Temperature Operating Life (LTOL)	T _a =-40℃, I _f =180mA	1,000 hours
5	High Temperature Storage Life (HTSL)	T _a =100℃	1,000 hours
6	Low Temperature Storage Life (LTSL)	T _a =-40℃	1,000 hours
7	Wet High Temperature Storage Life (WHTSL)	T _a =85℃, RH=85%	1,000 hours
8	Thermal Shock (TMSK)	100℃ ~ -40℃ Dwell : 15 min., Transfer : 10 sec.	200 cycles
9	Moisture Sensitivity Level (MSL)	T _{sld} =260℃ (Pre treatment 60℃, 60%, 168 hours)	3 times

※ All samples must pass each test item and all test items must be satisfied.

8. Packing of Products

8-1. Taping Outline Dimensions

▪ Reel

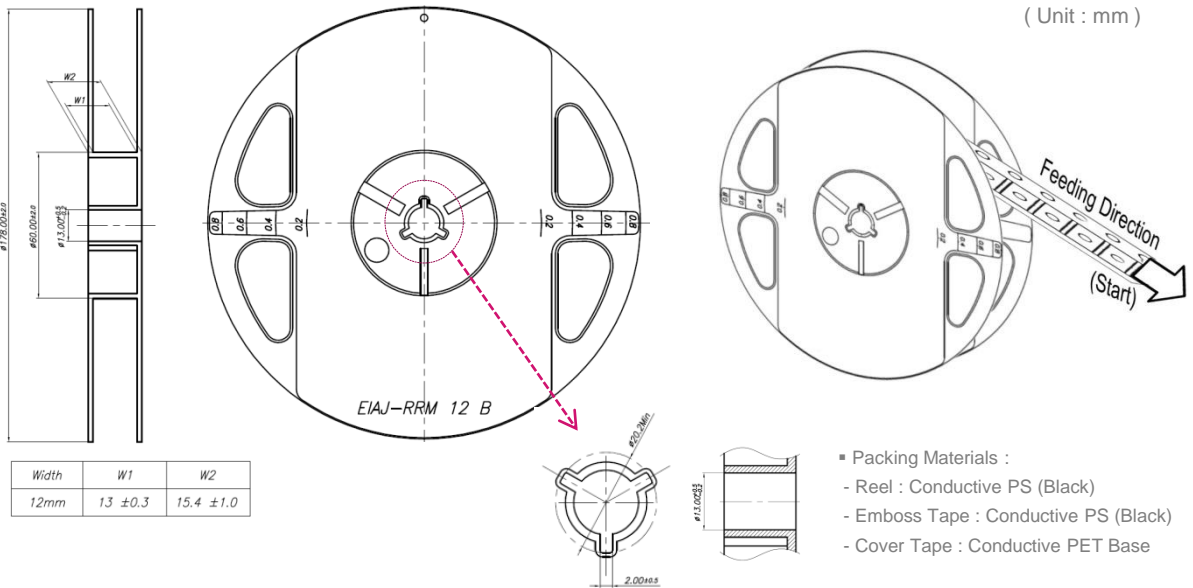

▪ Tape

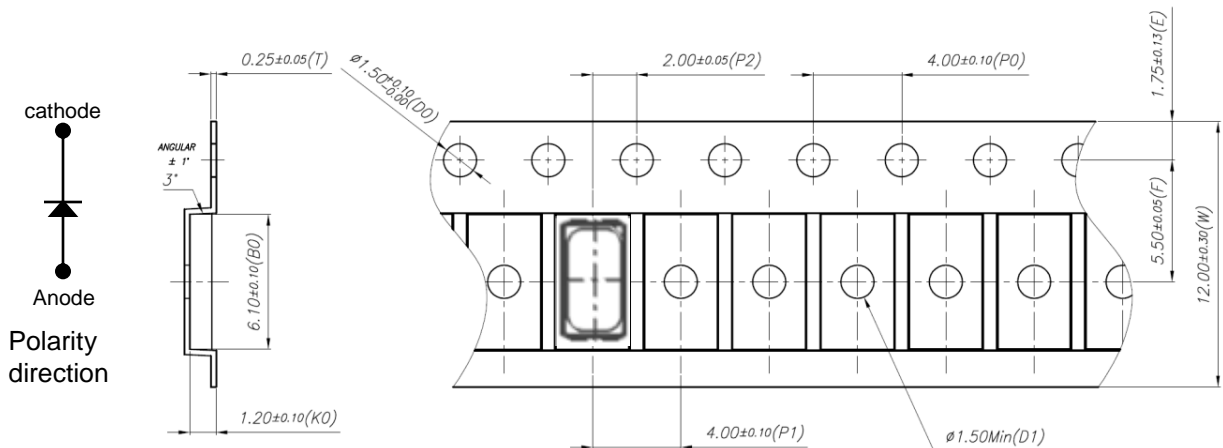

▪ Taping Arrangement



9. Cautions on Use

9-1. Moisture-Proof Package

- The moisture in the SMD package may vaporize and expand during soldering.
- The moisture can damage the optical characteristics of the LEDs due to the encapsulation.

9-2. During Storage

Conditions		Temperature	Humidity	Time
Storage	before Opening Aluminum Bag	< 30℃	< 50%RH	within 1 Year from Delivery Date
	after Opening Aluminum Bag	< 30℃	< 60%RH	≤ 672 hours
Baking		65 ± 5℃	< 10%RH	10 ~ 24 hours

9-3. During Usage

- The LED should avoid the direct contact with hazardous materials such as sulfur, chlorine, phthalate, etc..
- The metal parts on the LED can be rust when exposed to corrosive gases. Therefore, exposure to corrosive gases must be avoided.
- The corrosive atmosphere must be avoided during the use and storage.
- Extreme environments such as sudden ambient temperature changes or high humidity that can cause condensation must be avoided.

9-4. Cleaning

- Do not use brushes for cleaning or organic solvents (i.e. Acetone, TCE, etc..) for washing as they may damage the resin of the LEDs.
- IPA is the recommendable solvent for cleaning the LEDs under the following conditions.
Clearing Condition : IPA, 25℃ max. × 60sec max.
- Ultrasonic cleaning is not recommended.
- Conducting pretests to validate that the cleaning process won't damage the LED is recommended to avoid potential manufacturing problems from the cleaning process itself.

9. Cautions on Use

9-5. Heat Generation

- The thermal design of the end product must be thoroughly considered, particularly at the beginning of the end product design process.
- The generation of heat is greatly impacted by the input power, the thermal resistance of the circuit boards and the density of the LED array combined with other components.

9-6. Static Electricity

- Wristbands and anti-electrostatic gloves are strongly recommended and all devices, equipment and machinery must be properly grounded when handling the LEDs, which are sensitive against static electricity and surge.
- Precautions are to be taken against surge voltage to the equipment that mounts the LEDs.
- Unusual characteristics such as significant increase of current leakage, decrease of turn-on voltage, or non-operation at a low current can occur when the LED is damaged.

9-7. Recommended Circuit

- The current through each LED must not exceed the absolute maximum rating when design the circuits.
- In general, there can be various forward voltages for LEDs. Different forward voltages in parallel via a single resistor can result different forward currents to each LED, which also can output different luminous flux values. In the worst case, the currents can exceed the absolute maximum ratings which can stress the LEDs. Matrix circuit with a single resistor for each LED is recommended to avoid the luminous flux fluctuations.

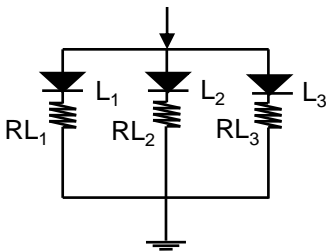

Fig.1 Recommended Circuit in Parallel Mode
: Separate resistors must be used for each LED.

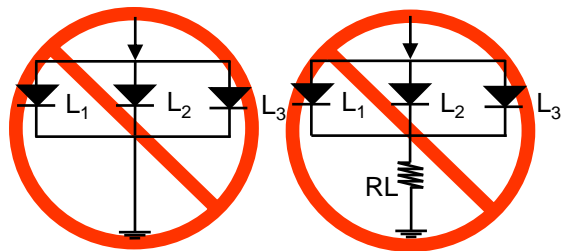

Fig.2. Abnormal Circuit
Circuits to Avoid: The current through the LEDs may vary due to the variation in LED forward voltage.

- The driving circuits must be designed and operated by forward bias only so that the LEDs are not to be operated by the reverse voltages while turned off, which can damage the LEDs.
- Reverse voltage can damage the zener diode, which can cause the LED to fail.
- Constant-current operation by a driver IC controller is recommended.

9. Cautions on Use

9-8. Soldering Conditions

- Reflow soldering method is recommended for LEDs assembly.
- LG Innotek does not guarantee the performance of the LEDs assembled by dip soldering method.
- Recommended Soldering Profile (according to JEDEC J-STD-020D)

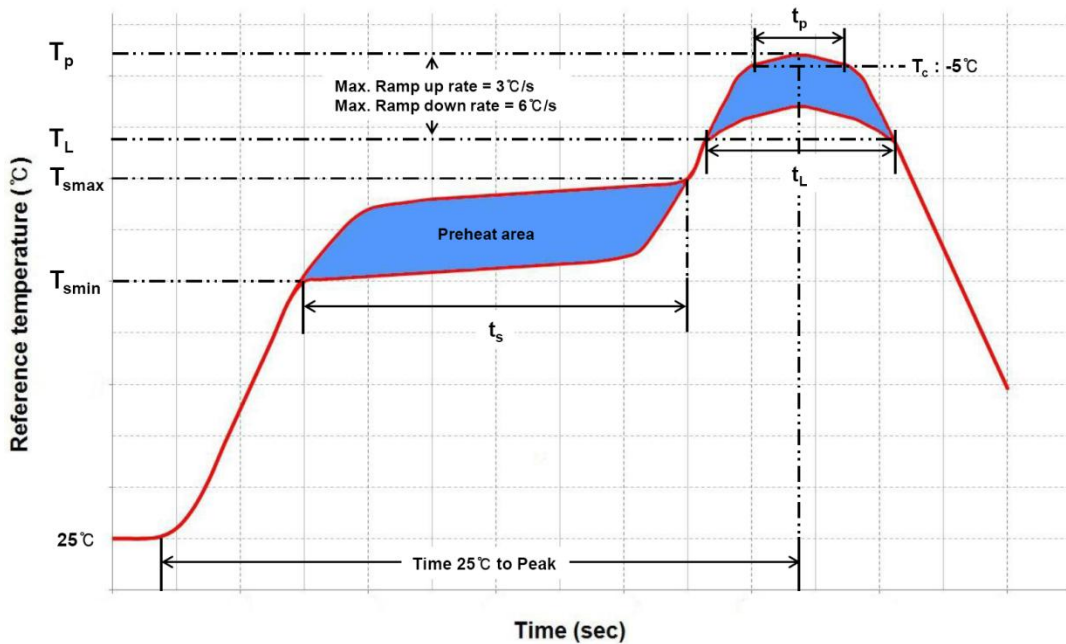

Profile Feature	Pb-Free Assembly	Pb-Based Assembly
Preheat/Soak		
Temperature Min(T_{smin})	150°C	100°C
Temperature Max(T_{smax})	200°C	150°C
Maximum time(t_s) from T_{smin} to T_{smax}	60~120 seconds	60~120 seconds
Ramp-up rate (T_L to T_p)	3°C/ second max.	3°C/ second max.
Liquidous temperature (T_L)	217°C	183°C
Time (t_L) maintained above T_L	60~150 seconds	60~150 seconds
Maximum peak package body temperature (T_p)	260°C	235°C
Time(t_p) within 5°C of the specified temperature (T_c)	30 seconds	20 seconds
Ramp-down rate (T_p to T_L)	6°C/second max.	6°C/second max.
Maximum Time 25°C to peak temperature	8 minutes max.	6 minutes max.

- Reflow or hand soldering at the lowest possible temperature is desirable for the LEDs although the recommended soldering conditions are specified in the above diagrams.
- A rapid cooling process is not recommended for the LEDs from the peak temperature.
- The silicone encapsulant at the top of the LED package is a soft surfaces on the tops, which can easily be damaged by pressure. Precautions should be taken to avoid strong pressure on the silicone encapsulant when leveraging the pick and place machines. The pick up nozzle should not directly contact the silicone resin of the LEDs.
- Reflow soldering should not be done more than two times.

9. Cautions on Use

9-9. Soldering Iron

- The recommended condition is less than 5 seconds at 260 °C.
- The time must be shorter for the higher temperatures. (+10 °C → -1sec).
- The power dissipation of the soldering iron should be lower than 15W and the surface temperature of the device should be controlled at or under 230 °C.

9-10. Eye Safety Guidelines

- Do not directly look at the light when the LEDs are on.
- Proceed with caution to avoid the risk of damage to the eyes when examining the LEDs with optical instruments.

9-11. Manual Handling

- Use Teflon-type tweezers to grab base of LED and do not apply mechanical pressure on the surface of the encapsulant.

