

Transient Voltage Suppressors for ESD Protection

General Description

The LESD9D3.3CT5G is designed to protect voltage sensitive components from ESD and transient voltage events. Excellent clamping capability, low leakage, and fast response time, make these parts ideal for ESD protection on designs where board space is at a premium. Because of its small size, it is suited for use in cellular phones, MP3 players, digital cameras and many other portable applications where board space is at a premium.

Applications

- Cellular phones
- Portable devices
- Digital cameras
- Power supplies

Features

- Small Body Outline Dimensions
- Low Body Height
- Peak Power up to 150 Watts @ 8 x 20 μ s Pulse
- Low Leakage current
- Response Time is Typically < 1 ns
- ESD Rating of Class 3 (> 16 kV) per Human Body Model
- IEC61000-4-2 Level 4 ESD Protection
- IEC61000-4-4 Level 4 EFT Protection

LESD9D3.3CT5G

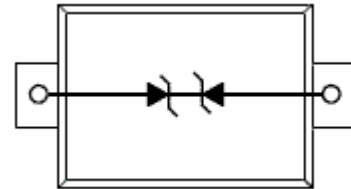

Absolute Ratings ($T_{amb}=25^{\circ}C$)

Symbol	Parameter	Value	Units
P_{PP}	Peak Pulse Power ($t_p = 8/20 \mu s$)	150	W
T_L	Maximum lead temperature for soldering during 10s	260	$^{\circ}C$
T_{stg}	Storage Temperature Range	-55 to +155	$^{\circ}C$
T_{op}	Operating Temperature Range	-40 to +125	$^{\circ}C$
T_j	Maximum junction temperature	150	$^{\circ}C$
	IEC61000-4-2 (ESD)	air discharge contact discharge	± 15 ± 8 KV
	IEC61000-4-4 (EFT)		40 A
	ESD Voltage	Per Human Body Model	16 KV

LESD9D3.3CT5G

Electrical Parameter

Symbol	Parameter
I_{PP}	Maximum Reverse Peak Pulse Current
V_C	Clamping Voltage @ I_{PP}
V_{RWM}	Working Peak Reverse Voltage
I_R	Maximum Reverse Leakage Current @ V_{RWM}
I_T	Test Current
V_{BR}	Breakdown Voltage @ I_T

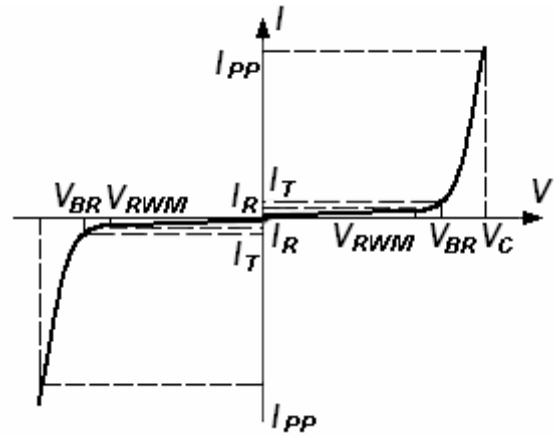

Electrical Characteristics

Ratings at 25°C ambient temperature unless otherwise specified. VF = 0.9V at IF = 10mA

Device	V_{RWM} (V)	I_R (uA) @ V_{RWM}	V_{BR} (V) @ I_T (Note 1)	I_T	V_C (V) @ $I_{PP}=5 A^*$	V_C (V) @ Max I_{PP}^*	I_{PP} (A)*	P_{PK} (W)*	C (pF)
	Max	Max	Min	mA	Typ	Max	Max	Max	Typ
LESD9D3.3CT5G	3.3	1	5.0	1.0	8.4	14.1	11.2	158	25

*Surge current waveform per Figure 1.

- V_{BR} is measured with a pulse test current I_T at an ambient temperature of 25°C.

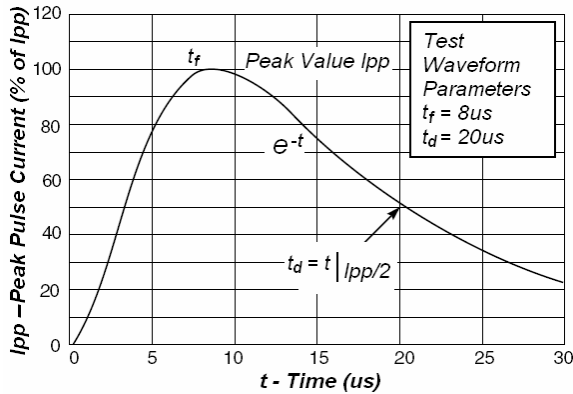

Fig1. Pulse Waveform

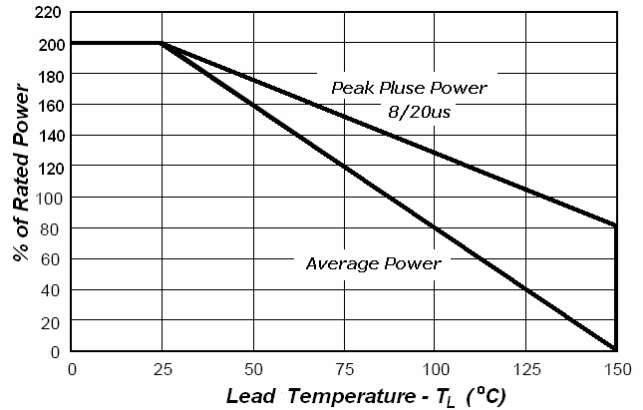
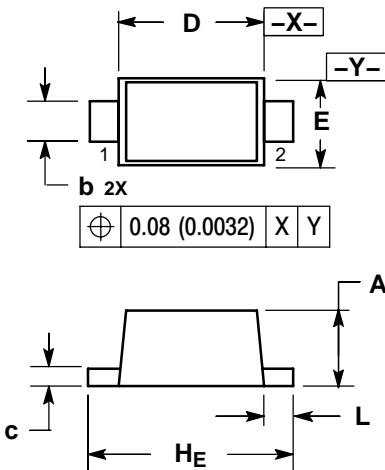

Fig2. Power Derating Curve

LESD9D3.3CT5G

SOD-923



NOTES:

1. DIMENSIONING AND TOLERANCING PER ANSI Y14.5M, 1982.
2. CONTROLLING DIMENSION: MILLIMETERS.
3. MAXIMUM LEAD THICKNESS INCLUDES LEAD FINISH THICKNESS. MINIMUM LEAD THICKNESS IS THE MINIMUM THICKNESS OF BASE MATERIAL.

DIM	MILLIMETERS			INCHES		
	MIN	NOM	MAX	MIN	NOM	MAX
A	0.34	0.37	0.40	0.013	0.015	0.016
b	0.15	0.20	0.25	0.006	0.008	0.010
c	0.07	0.12	0.17	0.003	0.005	0.007
D	0.75	0.80	0.85	0.030	0.031	0.033
E	0.55	0.60	0.65	0.022	0.024	0.026
H _E	0.95	1.00	1.05	0.037	0.039	0.041
L	0.05	0.10	0.15	0.002	0.004	0.006

SOLDERING FOOTPRINT*

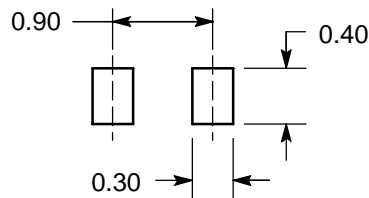

DIMENSIONS: MILLIMETERS

EMBOSSED TAPE AND REEL DATA FOR DISCRETES

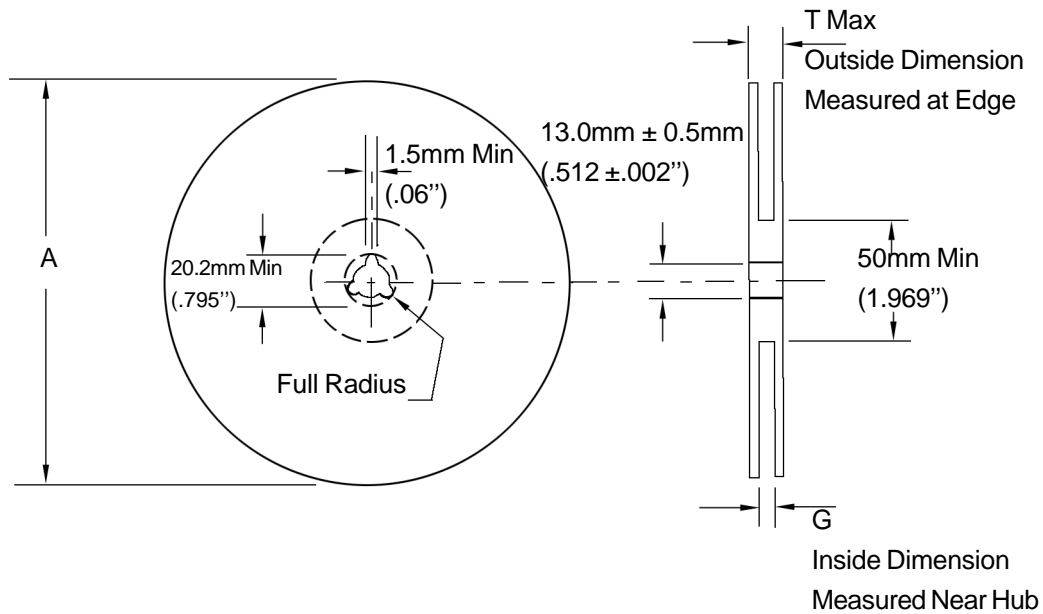

Size	A Max	G	T Max
8 mm	178.0mm (7.0")	8.4mm+1.5mm, -0.0 (.33"+.039", -0.00)	10.9mm (.43")

Reel Dimensions

Metric Dimensions Govern — English are in parentheses for reference only

Storage Conditions

Temperature: 5 to 40 Deg.C (20 to 30 Deg. C is preferred)

Humidity: 30 to 80 RH (40 to 60 is preferred)

Recommended Period: One year after manufacturing

(This recommended period is for the soldering condition only. The characteristics and reliabilities of the products are not restricted to this limitation)

Shipment Specification

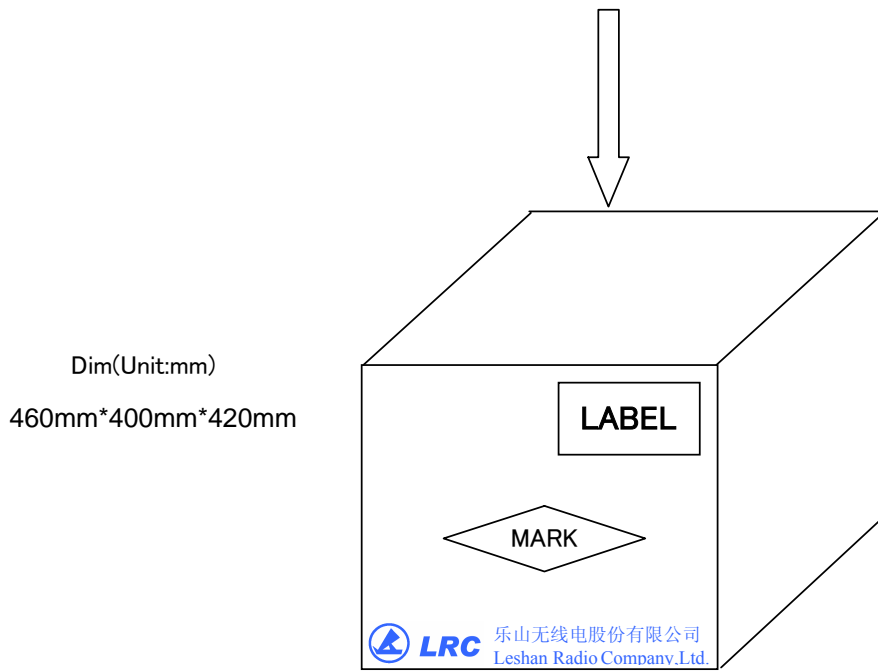
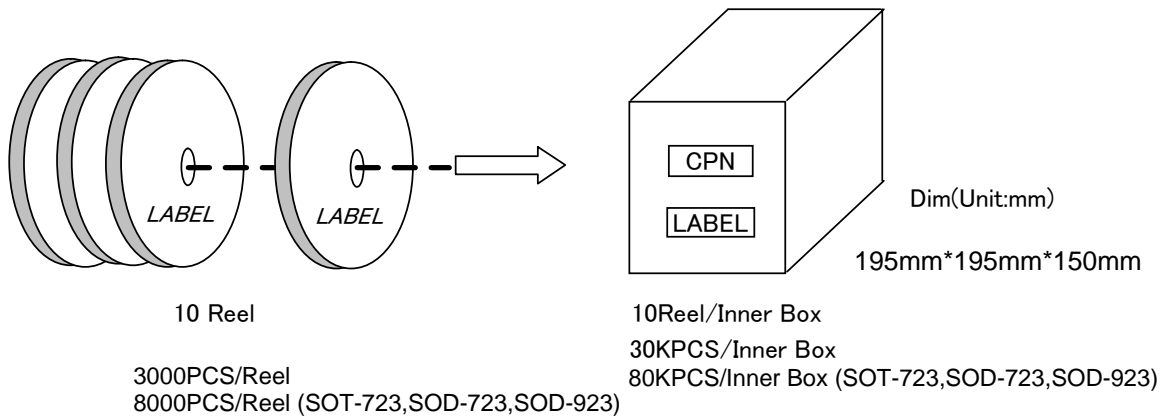

12 Inner Box/Carton

360KPCS/Carton
960KPCS/Carton (SOT-723,SOD-723,SOD-923)