

# LESD9D5.0T5G ESD PROTECTION DIODE

## Discription

The LESD9D5.0T5G is designed to protect voltage sensitive components from ESD. Excellent clamping capability, low leakage, and fast response time provide best in class protection on designs that are exposed to ESD. Because of its small size, it is suited for use in cellular phones, MP3 players, digital cameras and many other portable applications where board space is at a premium.

## Applications

- | Cellular phones audio
- | MP3 players
- | Digital cameras
- | Portable applications
- | mobile telephone

## Features

- | Small Body Outline Dimensions:  
0.039" x 0.024"(1.0 mm x 0.60 mm)
- | Low Body Height: 0.017" (0.43 mm) Max
- | Stand-off Voltage: 3.3 V – 12 V
- | Low Leakage
- | Response Time is Typically < 1 ns
- | ESD Rating of Class 3 (> 16 kV) per Human Body Model
- | IEC61000-4-2 Level 4 ESD Protection
- | These are Pb-Free Devices
- | We declare that the material of product compliance with RoHS requirements.

## MAXIMUM RATINGS

Rating	Symbol	Value	Unit
IEC 61000-4-2 (ESD) Air Contact Contact discharge		±15	kV
		±8	kV
ESD Voltage Per Human Body Model		16	kV
Total Power Dissipation on FR-5 Board (Note 1) @ T <sub>A</sub> =25°C	PD	150	Mw
Junction and Storage Temperature Range	T <sub>J</sub> ,T <sub>STG</sub>	-55 to 150	°C
Lead Solder Temperature – Maximum (10 Second Duration)	TL	260	°C

Stresses exceeding Maximum Ratings may damage the device. Maximum Rating are stress ratings only. Functional operation above the Recommended Operating Conditions is not implied. Extended exposure to stresses above the Recommended Operating Conditions may affect device reliability.

1. FR-5 = 1.0\*0.75\*0.62 in.

# LESD9D5.0T5G

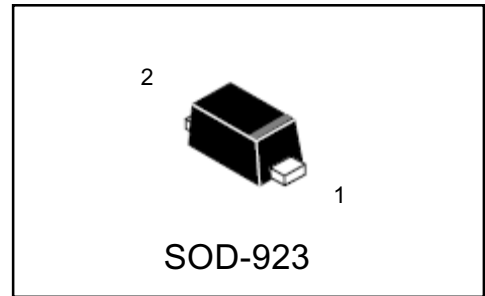

PIN 1. CATHODE  
2. ANODE

## Ordering information

Device	Package	Shipping
LESD9D5.0T5G	SOD-923	8000/Tape&Reel

# LESD9D5.0T5G

## ELECTRICAL CHARACTERISTICS

( $T_A = 25^\circ\text{C}$  unless otherwise noted)

Symbol	Parameter
$I_{PP}$	Maximum Reverse Peak Pulse Current
$V_C$	Clamping Voltage @ $I_{PP}$
$V_{RWM}$	Working Peak Reverse Voltage
$I_R$	Maximum Reverse Leakage Current @ $V_{RWM}$
$V_{BR}$	Breakdown Voltage @ $I_T$
$I_T$	Test Current
$I_F$	Forward Current
$V_F$	Forward Voltage @ $I_F$
$P_{pk}$	Peak Power Dissipation
C	Max. Capacitance @ $V_R = 0$ and $f = 1$ MHz

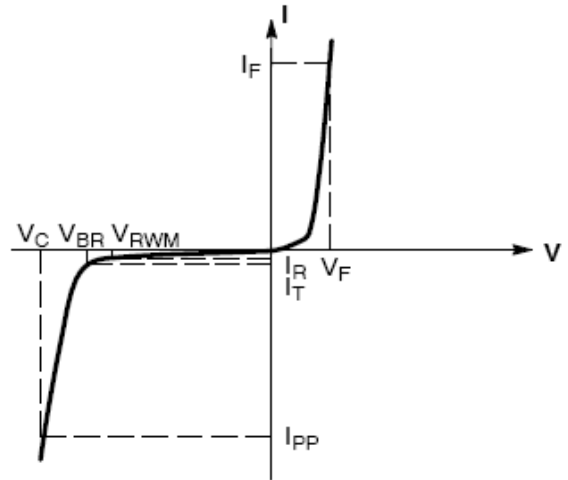

Uni-Directional TVS

## ELECTRICAL CHARACTERISTICS ( $T_A=25^\circ\text{C}$ unless otherwise noted, $V_F=0.9\text{V}$ Max. @ $I_F=10\text{Ma}$ for all types)

Device	$V_{RWM}$ (V)	$I_R$ ( $\mu\text{A}$ ) @ $V_{RWM}$	$V_{BR}$ (V) @ $I_T$ (Note 2)	$I_T$ (mA)	$I_{PP}$ (A) (Note 3)	$V_C$ (V) @ Max $I_{PP}$ (Note 3)	$P_{PK}$ (W) (8*20 $\mu\text{s}$ )	C (pF)
	Max	Max	Min		Max	Max	Typ	Typ
LESD9D3.3T5G	3.3	2.5	5.0	1.0	9.8	10.4	102	80
LESD9D5.0T5G	5.0	1.0	6.2	1.0	8.7	12.3	107	65
LESD9D12T5G	12	1.0	13.5	1.0	5.9	23.7	140	30

Other voltage available upon request.

- $V_{BR}$  is measured with a pulse test current  $I_T$  at an ambient temperature of  $25^\circ\text{C}$
- Surge current waveform per Figure 3.

# LESD9D5.0T5G

## TYPICAL CHARACTERISTICS

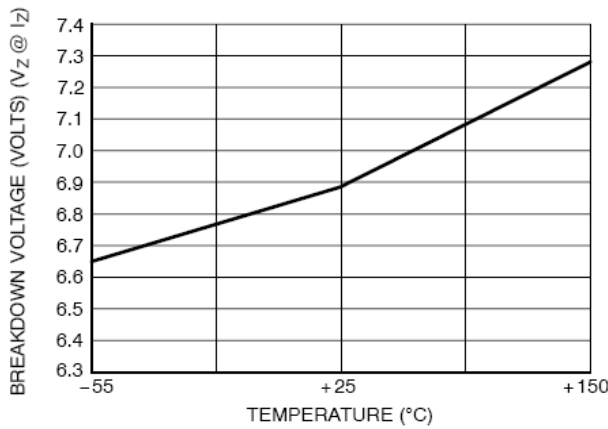

**Figure 1. Typical Breakdown Voltage versus Temperature**

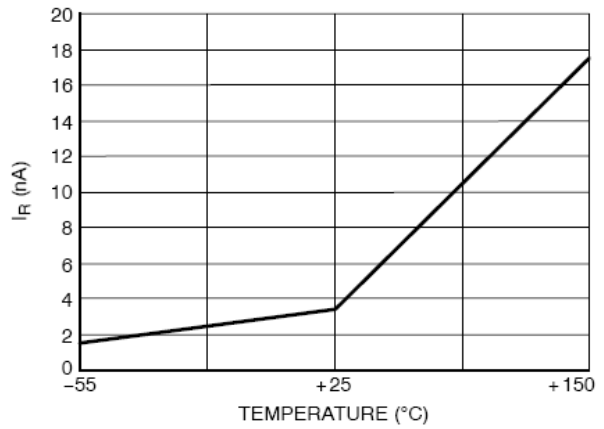

**Fig 2. Typical Leakage Current versus Temperature**

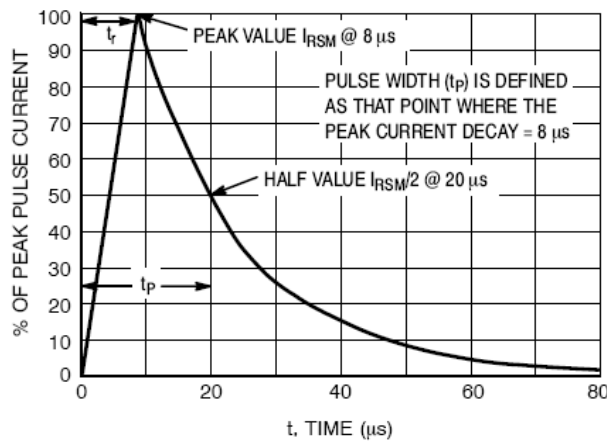

**Figure 3. 8\*20  $\mu s$  Pulse Waveform**

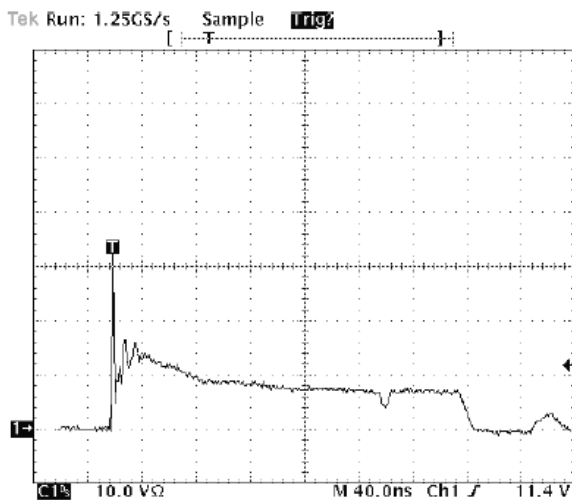

**Figure 4. Positive 8kV contact per IEC 61000-4-2-LESD9D5.0T5G**

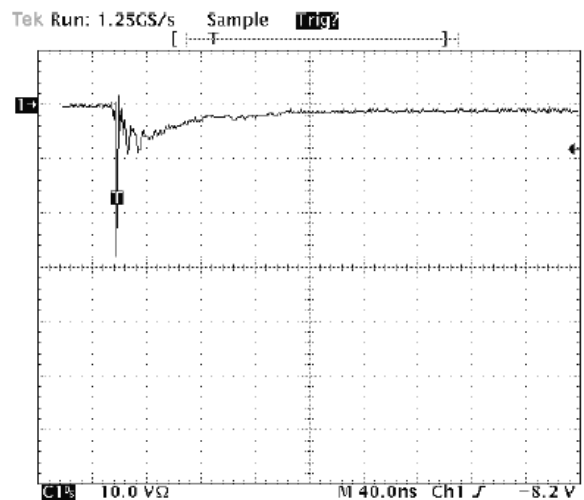

**Fig 5. Negative 8kV contact per IEC 61000-4-2-LESD9D5.0T5G**

# LESD9D5.0T5G

SOD-923

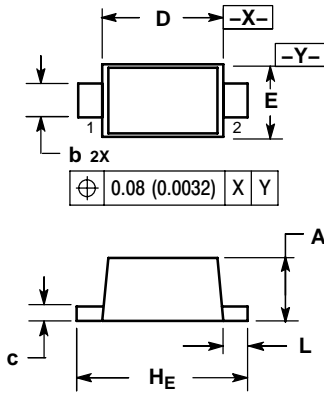

- NOTES:
1. DIMENSIONING AND TOLERANCING PER ANSI Y14.5M, 1982.
  2. CONTROLLING DIMENSION: MILLIMETERS.
  3. MAXIMUM LEAD THICKNESS INCLUDES LEAD FINISH THICKNESS. MINIMUM LEAD THICKNESS IS THE MINIMUM THICKNESS OF BASE MATERIAL.

DIM	MILLIMETERS			INCHES		
	MIN	NOM	MAX	MIN	NOM	MAX
A	0.34	0.37	0.40	0.013	0.015	0.016
b	0.15	0.20	0.25	0.006	0.008	0.010
c	0.07	0.12	0.17	0.003	0.005	0.007
D	0.75	0.80	0.85	0.030	0.031	0.033
E	0.55	0.60	0.65	0.022	0.024	0.026
H <sub>E</sub>	0.95	1.00	1.05	0.037	0.039	0.041
L	0.05	0.10	0.15	0.002	0.004	0.006

### SOLDERING FOOTPRINT\*

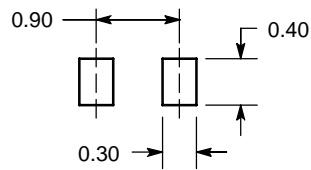

DIMENSIONS: MILLIMETERS

## EMBOSSED TAPE AND REEL DATA FOR DISCRETES

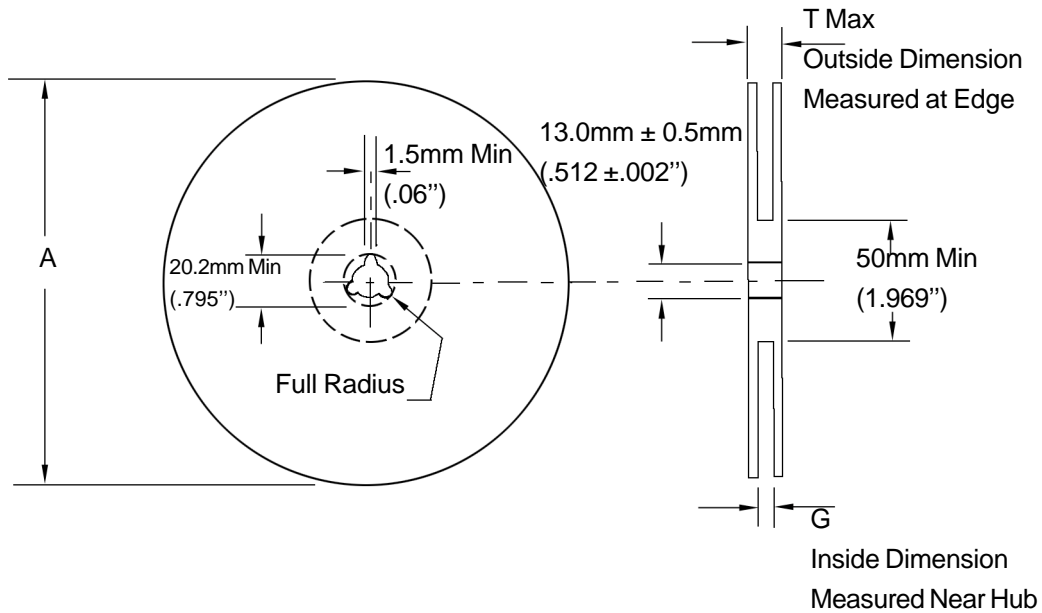

Size	A Max	G	T Max
8 mm	178.0mm (7.0")	8.4mm+1.5mm, -0.0 (.33"+.039", -0.00)	10.9mm (.43")

### Reel Dimensions

Metric Dimensions Govern — English are in parentheses for reference only

### Storage Conditions

Temperature: 5 to 40 Deg.C (20 to 30 Deg. C is preferred)

Humidity: 30 to 80 RH (40 to 60 is preferred )

Recommended Period: One year after manufacturing

(This recommended period is for the soldering condition only. The characteristics and reliabilities of the products are not restricted to this limitation)

## Shipment Specification

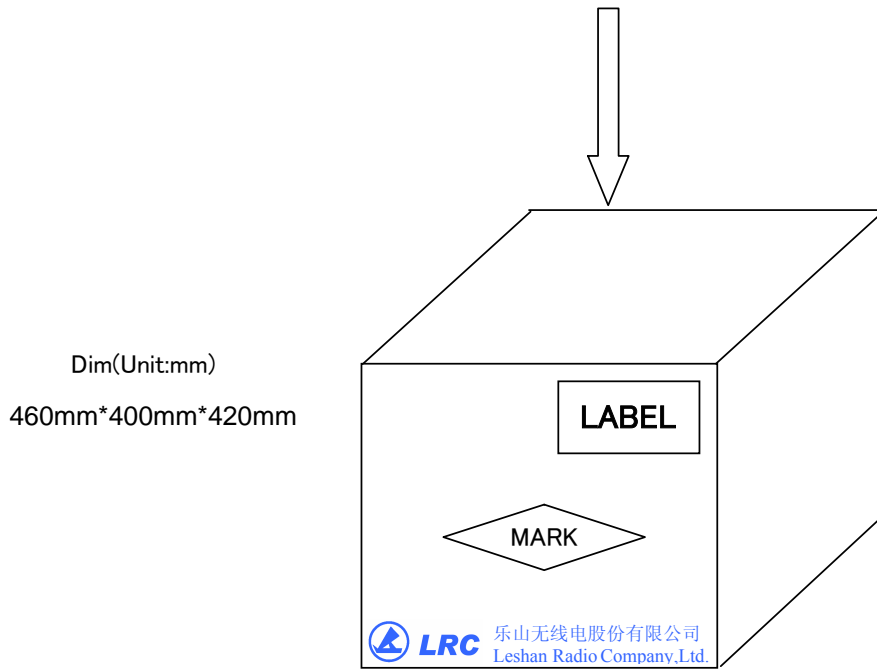
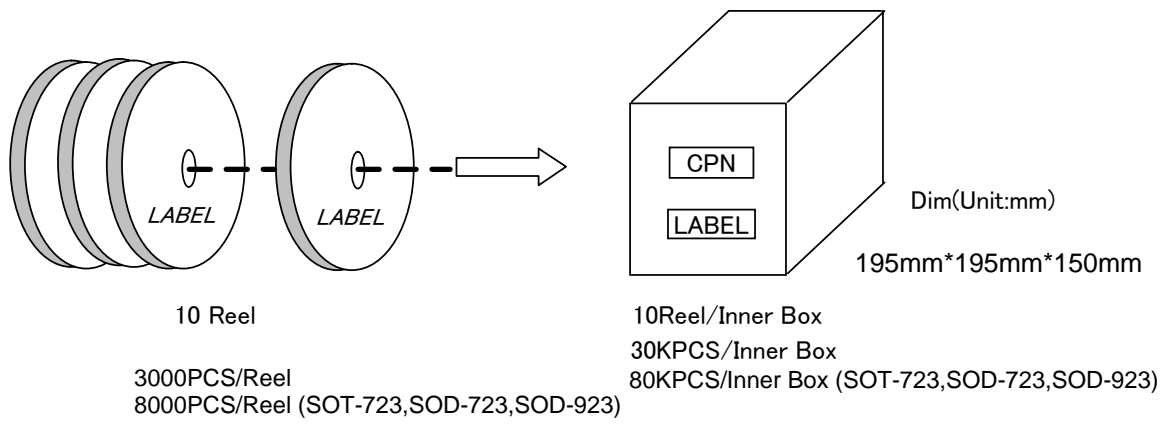

12 Inner Box/Carton

360KPCS/Carton  
960KPCS/Carton (SOT-723,SOD-723,SOD-923)