

## Quad Array for ESD Protection

This quad monolithic silicon voltage suppressor is designed for applications requiring transient overvoltage protection capability. It is intended for use in voltage and ESD sensitive equipment such as computers, printers, business machines, communication systems, medical equipment, and other applications. Its quad junction common anode design protects four separate lines using only one package. These devices are ideal for situations where board space is at a premium.

### Specification Features

- SOT-553 Package Allows Four Separate Unidirectional Configurations
- Low Leakage < 1  $\mu$ A @ 3 Volt
- Breakdown Voltage: 5.6 Volt - 6.8 Volt @ 1 mA
- ESD Protection Meeting IEC61000-4-2 - Level 4
- We declare that the material of product compliance with RoHS requirements.

### Mechanical Characteristics

- Void Free, Transfer-Molded, Thermosetting Plastic Case
- Corrosion Resistant Finish, Easily Solderable
- Package Designed for Optimal Automated Board Assembly
- Small Package Size for High Density Applications
- 100% Lead Free, MSL1 @ 260°C Reflow Temperature

## LESDA5V6V5T1G

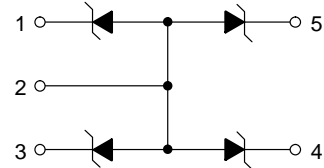
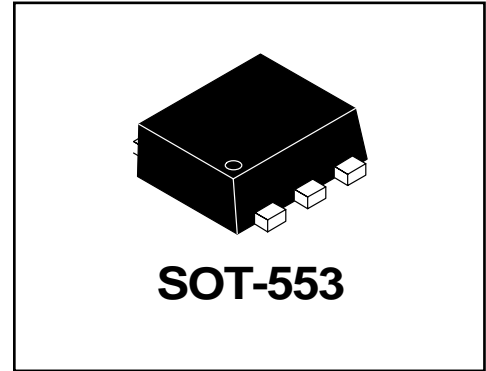

### ORDERING INFORMATION

Device	Package	Shipping
LESDA5V6V5T1G	SOT-553	3000/Tape & Reel
LESDA6V2V5T1G	SOT-553	3000/Tape & Reel
LESDA6V8V5T1G	SOT-553	3000/Tape & Reel

**ELECTRICAL CHARACTERISTICS**

 (T<sub>A</sub> = 25°C unless otherwise noted)

Symbol	Parameter
I <sub>PP</sub>	Maximum Reverse Peak Pulse Current
V <sub>C</sub>	Clamping Voltage @ I <sub>PP</sub>
V <sub>RWM</sub>	Working Peak Reverse Voltage
I <sub>R</sub>	Maximum Reverse Leakage Current @ V <sub>RWM</sub>
V <sub>BR</sub>	Breakdown Voltage @ I <sub>T</sub>
I <sub>T</sub>	Test Current
ΘV <sub>BR</sub>	Maximum Temperature Coefficient of V <sub>BR</sub>
I <sub>F</sub>	Forward Current
V <sub>F</sub>	Forward Voltage @ I <sub>F</sub>
Z <sub>ZT</sub>	Maximum Zener Impedance @ I <sub>ZT</sub>
I <sub>ZK</sub>	Reverse Current
Z <sub>ZK</sub>	Maximum Zener Impedance @ I <sub>ZK</sub>

# LESDA5V6V5T1G

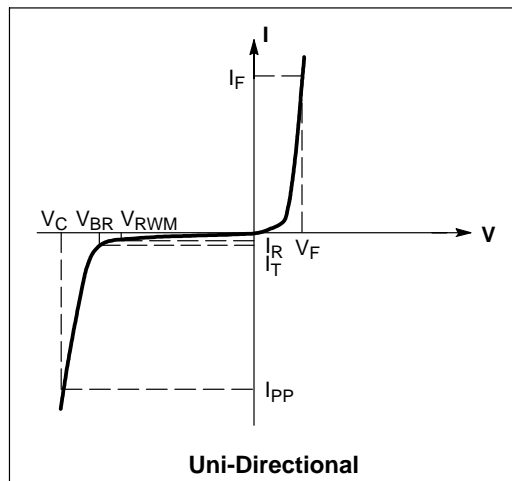
**MAXIMUM RATINGS** (T<sub>A</sub> = 25°C unless otherwise noted)

Characteristic	Symbol	Value	Unit
Peak Power Dissipation (8 X 20 μs @ T <sub>A</sub> = 25°C) (Note 1)	P <sub>PK</sub>	100	W
Steady State Power - 1 Diode (Note 2)	P <sub>D</sub>	300	mW
Thermal Resistance Junction to Ambient Above 25°C, Derate	R <sub>θJA</sub>	370 2.7	°C/W mW/°C
Maximum Junction Temperature	T <sub>Jmax</sub>	150	°C
Operating Junction and Storage Temperature Range	T <sub>J</sub> T <sub>stg</sub>	-55 to +150	°C
ESD Discharge MIL STD 883C - Method 3015-6 IEC1000-4-2, Air Discharge IEC1000-4-2, Contact Discharge	V <sub>PP</sub>	16 16 9	kV
Lead Solder Temperature (10 seconds duration)	T <sub>L</sub>	260	°C

**ELECTRICAL CHARACTERISTICS** (T<sub>A</sub> = 25°C)

Device	Breakdown Voltage V <sub>BR</sub> @ 1 mA (Volts)			Leakage Current I <sub>RM</sub> @ V <sub>RM</sub>		V <sub>C</sub> Max @ I <sub>PP</sub>		Typ Capacitance @ 0 V Bias (Note 3)	Max V <sub>F</sub> @ I <sub>F</sub> = 200 mA
	Min	Nom	Max	V <sub>RWM</sub>	I <sub>RWM</sub> (μA)	V <sub>C</sub> (V)	I <sub>PP</sub> (A)	(pF)	(V)
LESDA5V6V5T1G	5.32	5.6	5.88	3.0	1.0	10.5	10	90	1.3
LESDA6V2V5T1G	5.89	6.2	6.51	4.0	0.5	11.5	9.0	80	1.3
LESDA6V8V5T1G	6.46	6.8	7.14	4.3	0.1	12.5	8.0	70	1.3

1. Non-repetitive current per Figure 1.
2. Only 1 diode under power. For all 4 diodes under power, P<sub>D</sub> will be 25%. Mounted on FR-4 board with min pad.
3. Capacitance of one diode at f = 1 MHz, V<sub>R</sub> = 0 V, T<sub>A</sub> = 25°C

# LESDA5V6V5T1G

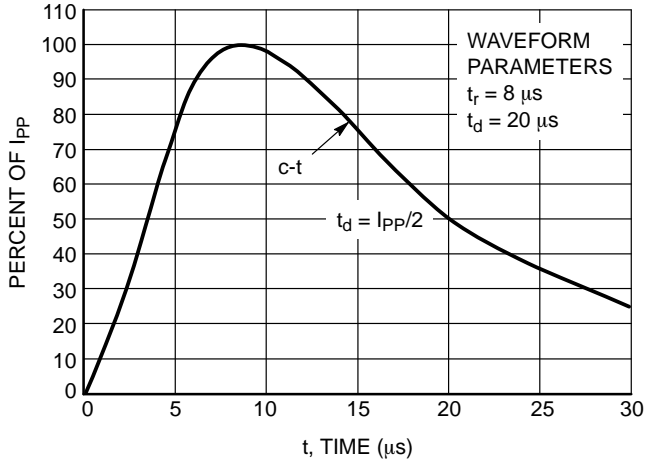

Figure 1. Pulse Waveform

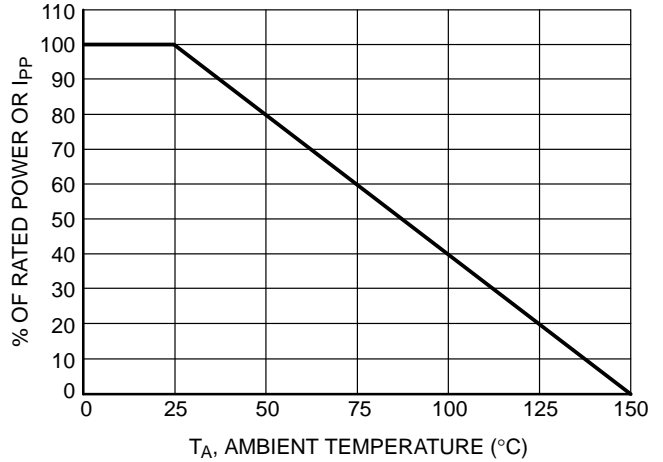

Figure 2. Power Derating Curve

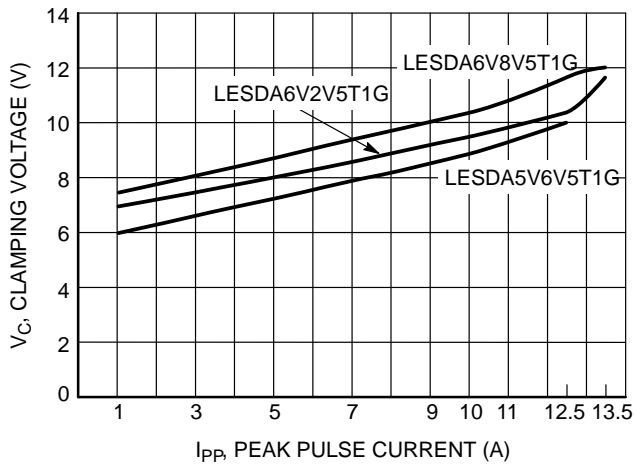

Figure 3. Clamping Voltage versus Peak Pulse Current

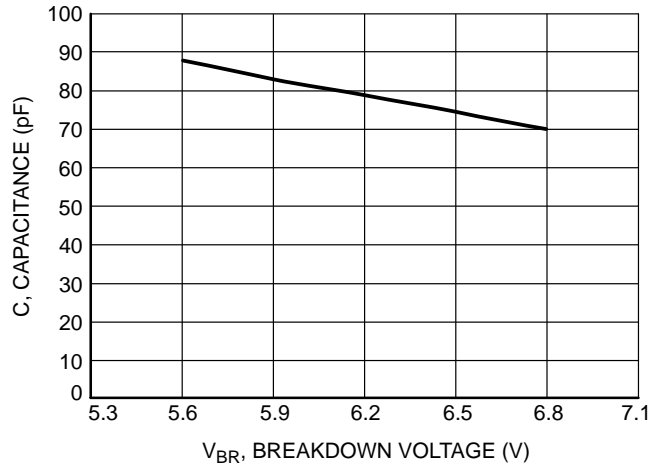
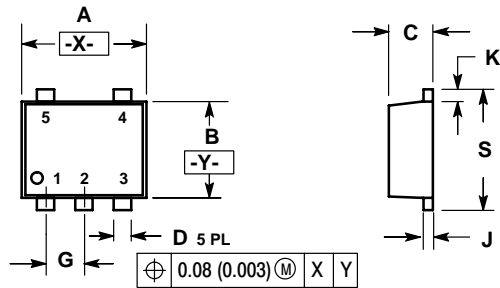

Figure 4. Typical Capacitance

# LESDA5V6V5T1G

## PACKAGE DIMENSIONS

### SOT-553, 5-LEAD



#### NOTES:

1. DIMENSIONING AND TOLERANCING PER ANSI Y14.5M, 1982.
2. CONTROLLING DIMENSION: MILLIMETERS
3. MAXIMUM LEAD THICKNESS INCLUDES LEAD FINISH THICKNESS. MINIMUM LEAD THICKNESS IS THE MINIMUM THICKNESS OF BASE MATERIAL.

DIM	MILLIMETERS		INCHES	
	MIN	MAX	MIN	MAX
<b>A</b>	1.50	1.70	0.059	0.067
<b>B</b>	1.10	1.30	0.043	0.051
<b>C</b>	0.50	0.60	0.020	0.024
<b>D</b>	0.17	0.27	0.007	0.011
<b>G</b>	0.50 BSC		0.020 BSC	
<b>J</b>	0.08	0.18	0.003	0.007
<b>K</b>	0.10	0.30	0.004	0.012
<b>S</b>	1.50	1.70	0.059	0.067

#### STYLE 1:

1. BASE 1
2. EMITTER 1/2
3. BASE 2
4. COLLECTOR 2
5. COLLECTOR 1

#### STYLE 2:

1. CATHODE
2. ANODE
3. CATHODE
4. CATHODE
5. CATHODE

## EMBOSSED TAPE AND REEL DATA FOR DISCRETES

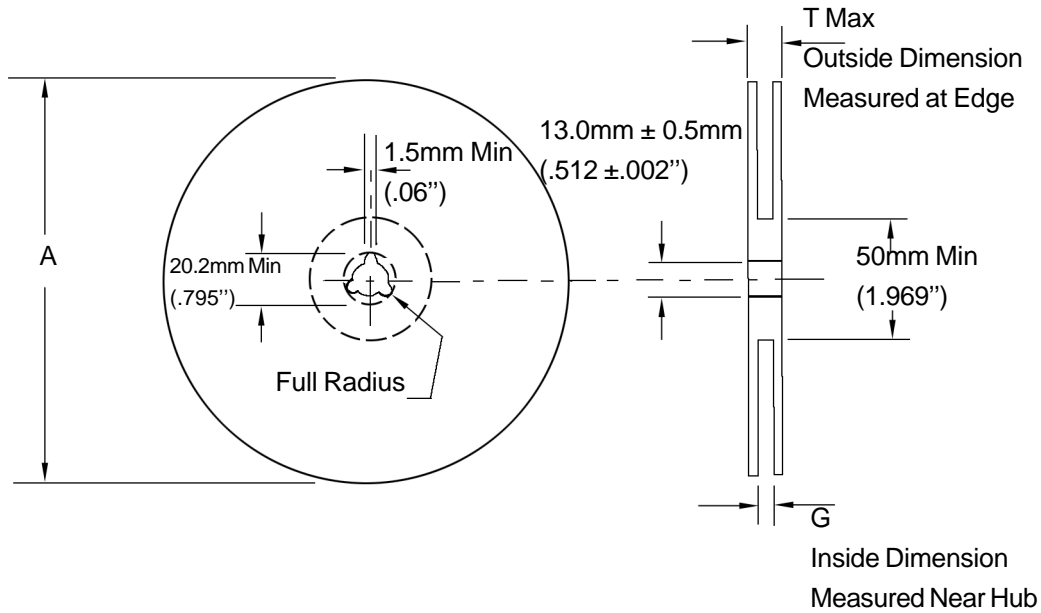

Size	A Max	G	T Max
8 mm	330mm (12.992")	8.4mm+1.5mm, -0.0 (.33"+.059", -0.00)	14.4mm (.56")

### Reel Dimensions

Metric Dimensions Govern — English are in parentheses for reference only

#### Storage Conditions

Temperature: 5 to 40 Deg.C (20 to 30 Deg. C is preferred)

Humidity: 30 to 80 RH (40 to 60 is preferred )

Recommended Period: One year after manufacturing

(This recommended period is for the soldering condition only. The characteristics and reliabilities of the products are not restricted to this limitation)

## Shipment Specification

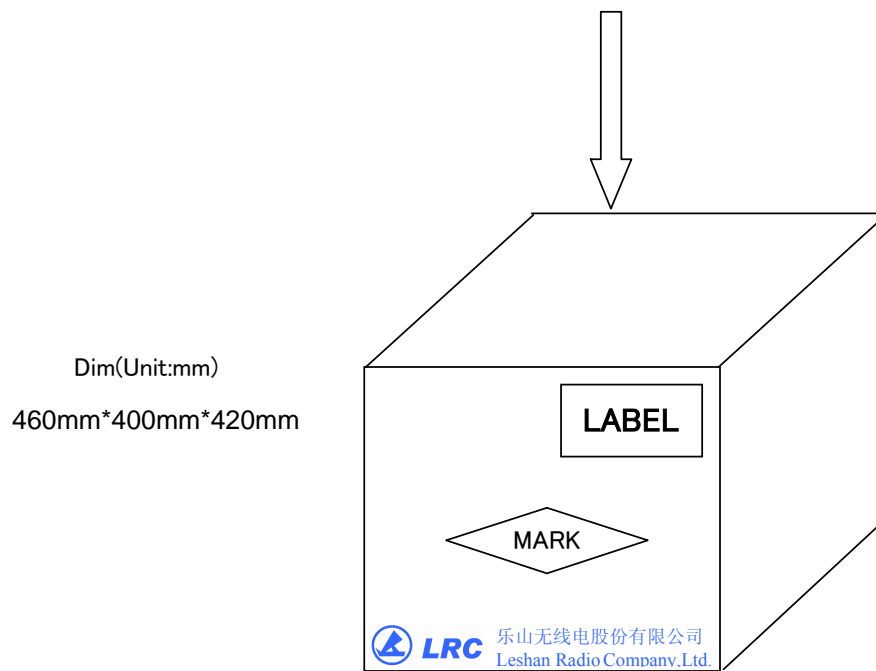
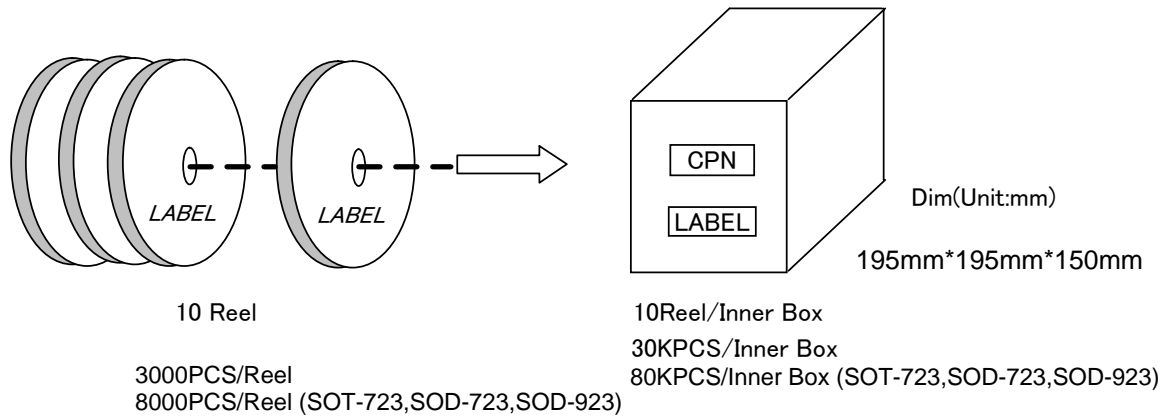

12 Inner Box/Carton

360KPCS/Carton  
960KPCS/Carton (SOT-723,SOD-723,SOD-923)