

# Low Capacitance Quad Array for ESD Protection

## General Description

Low capacitance 5-fold ESD protection array in the very small SOT363 plastic package designed to protect up to five transmission or data lines from the damage caused by Electrostatic Discharge (ESD).

## Applications

- Cellular handsets and accessories
- Portable electronics
- Computers and peripherals
- Communications systems
- Audio and video equipment.

## Features

- Uni-directional ESD protection of up to five lines
- Bi-directional ESD protection of up to four lines
- Low diode capacitance
- Low clamping voltage
- low leakage current
- IEC 61000-4-2; level 4 (ESD)
- IEC61000-4-5 (surge)

**LESDA5VAW6T1G**

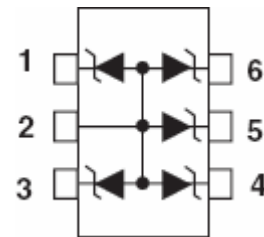
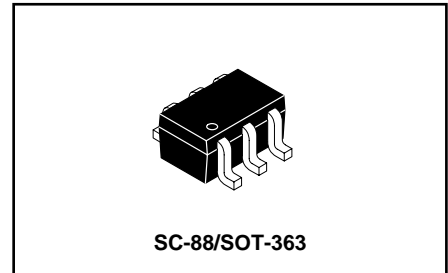

## ORDERING INFORMATION

Device	Package	Shipping
LESDA5VAW6T1G	SC-88	3000/Tape & Reel

## Absolute Ratings (T<sub>amb</sub>=25°C )

Symbol	Parameter	Value	Units
P <sub>PP</sub>	Peak Pulse Power (t <sub>p</sub> = 8/20μs)	25	W
T <sub>L</sub>	Maximum lead temperature for soldering during 10s	260	°C
T <sub>stg</sub>	Storage Temperature Range	-60 to +150	°C
T <sub>op</sub>	Operating Temperature Range	-60 to +150	°C
T <sub>j</sub>	Maximum junction temperature	150	°C
V <sub>PP</sub>	Electrostatic discharge		
	IEC61000-4-2 (contact discharge)	8	kV
	IEC61000-4-2 (air discharge)	15	kV

# LESDA5VAW6T1G

## Electrical Parameter

Symbol	Parameter
$V_{RM}$	Stand-off voltage
$V_{BR}$	Breakdown voltage
$V_{CL}$	Clamping voltage
$I_R$	Leakage current
$I_{PP}$	Peak pulse current
$C$	Capacitance

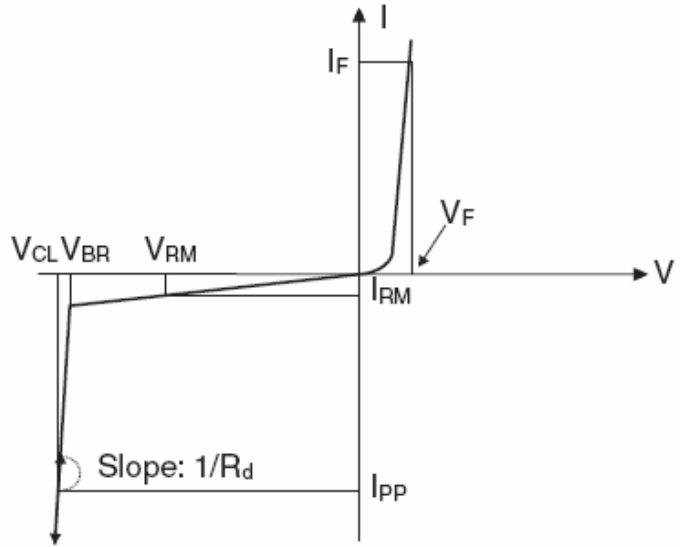

## Electrical Characteristics

Part Numbers	$V_{BR}$		$V_{RM}$	$I_R$	$I_{PP}$	$V_{CL}$ (Max)		$C$
	Min.	Max.				@ $I_{PP}=1A$	@ $I_{PP}=2.5A$	
LESDA5VAW6T1G	6.4	7.2	5	1	2.5	10	12	15

### Notes

1. Non-repetitive current pulse 8/20  $\mu s$  exponentially decaying waveform; see Fig.1.
2. Measured from any of pins 1, 3, 4, 5 or 6 to pin 2.

## GRAPHICAL DATA

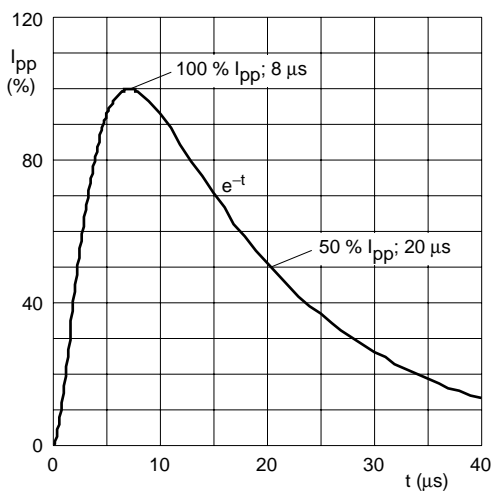

Fig.1 8/20  $\mu s$  pulse waveform according to IEC 61000-4-5.

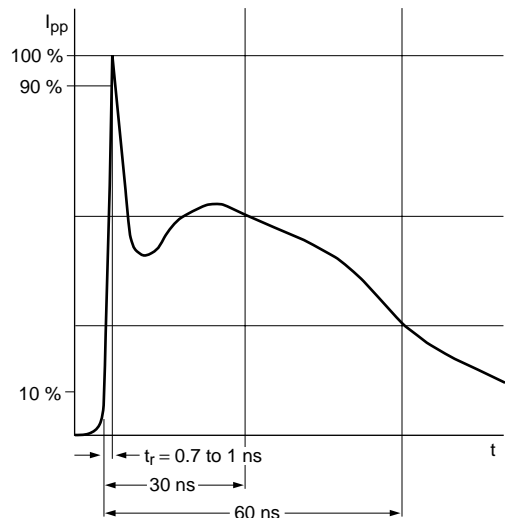
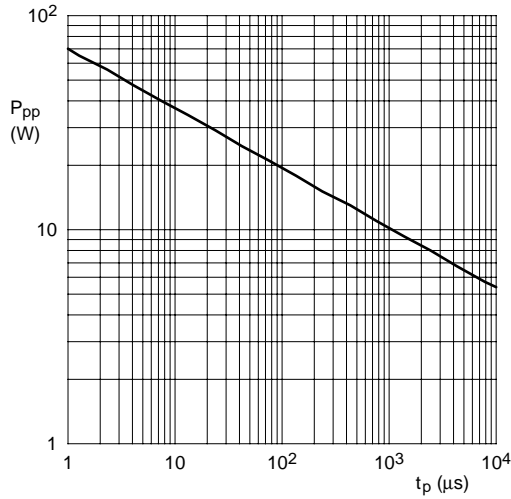

Fig.2 Electrostatic Discharge (ESD) pulse waveform according to IEC 61000-4-2.

# LESDA5VAW6T1G

## GRAPHICAL DATA



$T_{amb} = 25\text{ }^{\circ}\text{C}$ .  
 $I_{pp} = 8/20\text{ }\mu\text{s}$  exponentially decaying waveform; see Fig.1.

Fig.3 Peak pulse power dissipation as a function of pulse time; typical values.

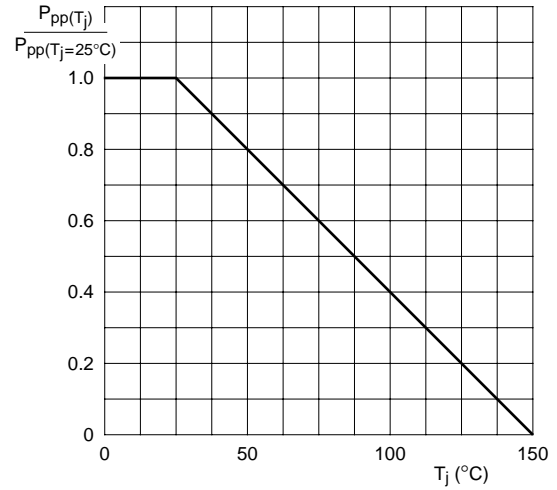
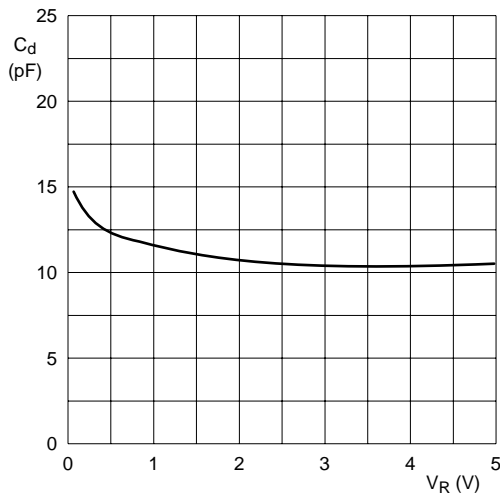

Fig.4 Relative variation of peak pulse power as a function of junction temperature; typical values.



$f = 1\text{ MHz}$ ;  $T_{amb} = 25\text{ }^{\circ}\text{C}$ .

Fig.5 Diode capacitance as a function of reverse voltage; typical values.

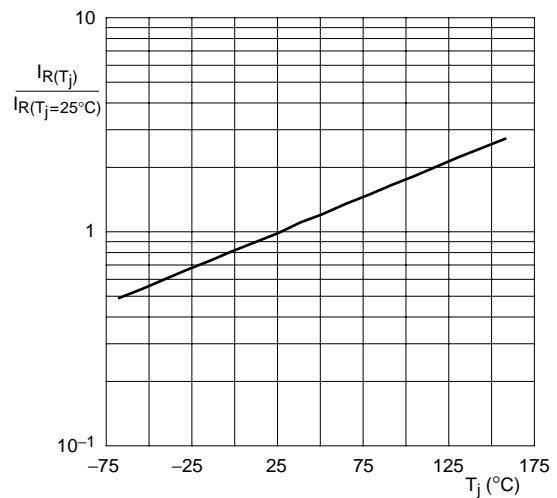
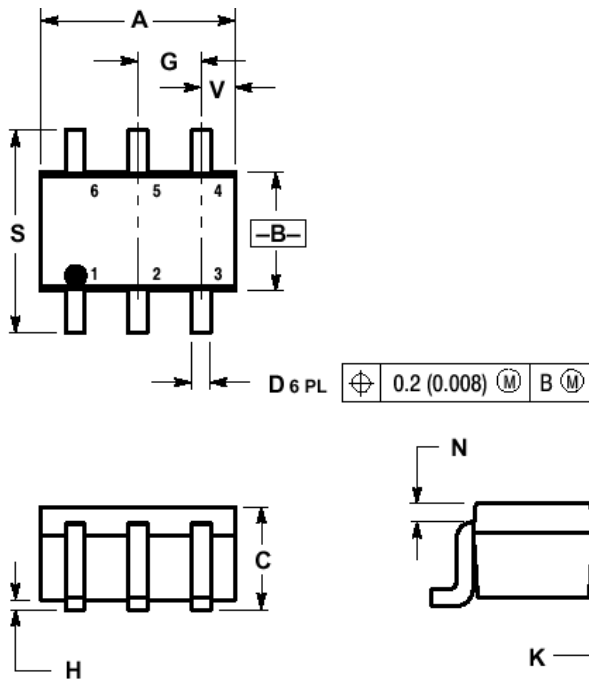

Fig.6 Relative variation of reverse leakage current as a function of junction temperature; typical values.

# LESDA5VAW6T1G

## PACKAGE DIMENSIONS SC-88/SOT-363



**NOTES:**

1. DIMENSIONING AND TOLERANCING PER ANSI Y14.5M, 1982.
2. CONTROLLING DIMENSION: INCH.

DIM	INCHES		MILLIMETERS	
	MIN	MAX	MIN	MAX
A	0.071	0.087	1.80	2.20
B	0.045	0.053	1.15	1.35
C	0.031	0.043	0.80	1.10
D	0.004	0.012	0.10	0.30
G	0.026BSC		0.65BSC	
H	—	0.004	—	0.10
J	0.004	0.010	0.10	0.25
K	0.004	0.012	0.10	0.30
N	0.008 REF		0.20 REF	
S	0.079	0.087	2.00	2.20
V	0.012	0.016	0.30	0.40

## EMBOSSED TAPE AND REEL DATA FOR DISCRETES

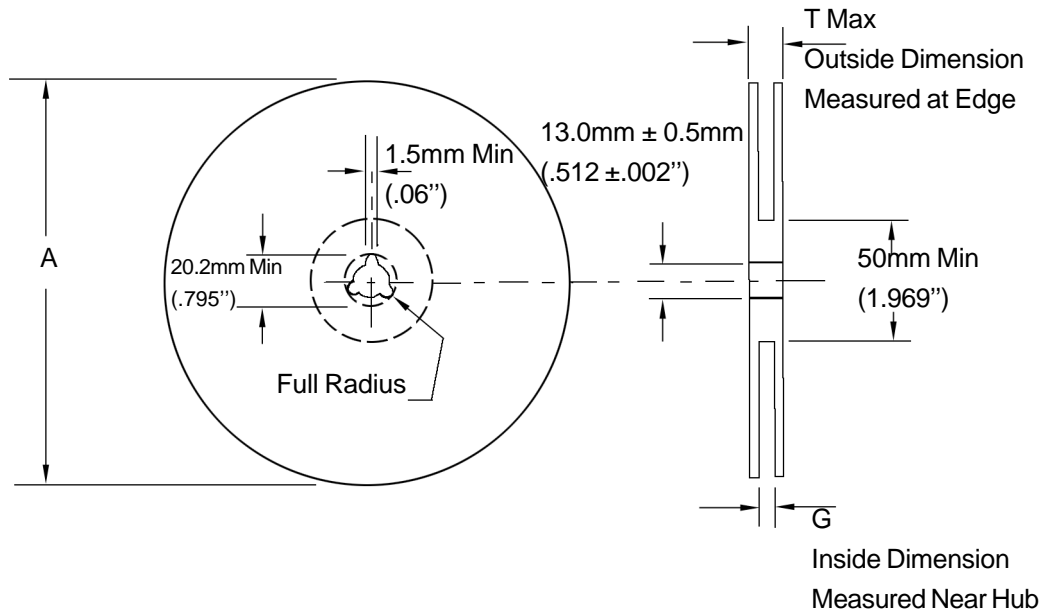

Size	A Max	G	T Max
8 mm	178.0mm (7.0")	8.4mm+1.5mm, -0.0 (.33"+.039", -0.00)	10.9mm (.43")

### Reel Dimensions

Metric Dimensions Govern — English are in parentheses for reference only

#### Storage Conditions

Temperature: 5 to 40 Deg.C (20 to 30 Deg. C is preferred)

Humidity: 30 to 80 RH (40 to 60 is preferred )

Recommended Period: One year after manufacturing

(This recommended period is for the soldering condition only. The characteristics and reliabilities of the products are not restricted to this limitation)

## Shipment Specification

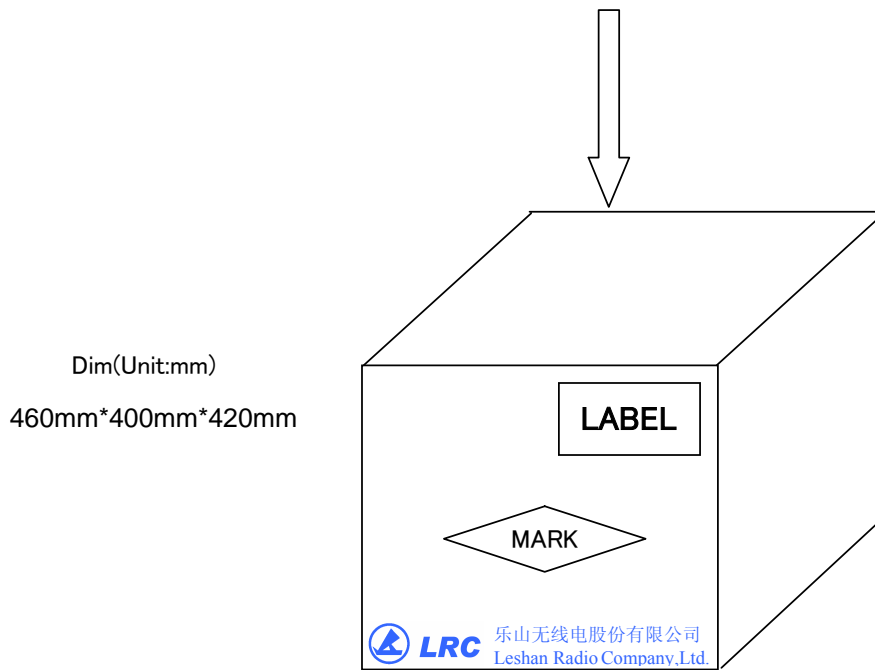
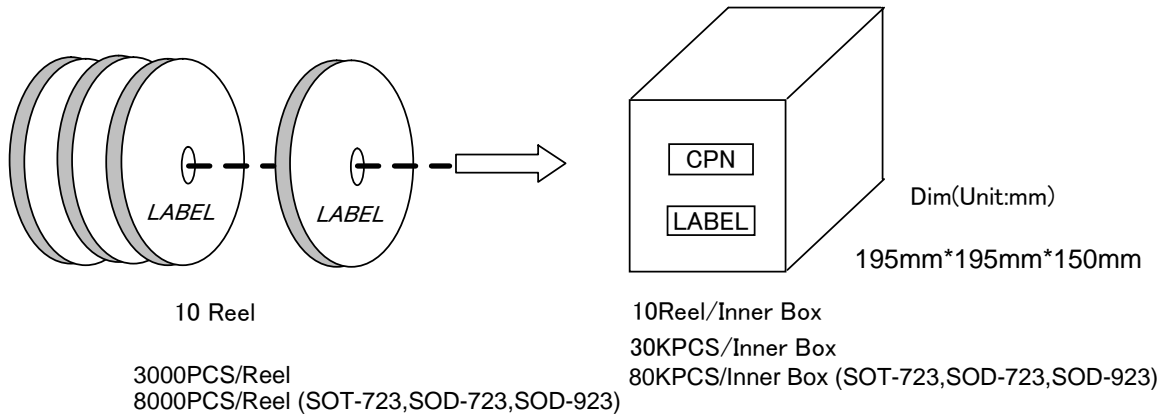

12 Inner Box/Carton

360KPCS/Carton  
960KPCS/Carton (SOT-723,SOD-723,SOD-923)