

Low Capacitance Quad Array for ESD Protection

General Description

This integrated transient voltage suppressor device (TVS) is designed for applications requiring transient overvoltage protection. It is intended for use in sensitive equipment such as computers, printers, business machines, communication systems, medical equipment, and other applications. Its integrated design provides very effective and reliable protection for four separate lines using only one package. These devices are ideal for situations where board space is at a premium.

Features

- ESD Protection: IEC61000-4-2: Level 4
MILSTD 883C – Method 3015-6: Class 3
- Four Separate Unidirectional Configurations for Protection
- Low Leakage Current < 1 μ A
- Power Dissipation: 380 mW
- Small SC-88A SMT Package
- Low Capacitance
- Pb-Free Package is Available

Benefits

- Provides Protection for ESD Industry Standards: IEC 61000, HBM
- Protects the Line Against Transient Voltage Conditions in Either Direction
- Minimize Power Consumption of the System
- Minimize PCB Board Space

Typical Applications

- Instrumentation Equipment
- Serial and Parallel Ports
- Microprocessor Based Equipment
- Notebooks, Desktops, Servers
- Cellular and Portable Equipment

LESDA6V8AW5T1G

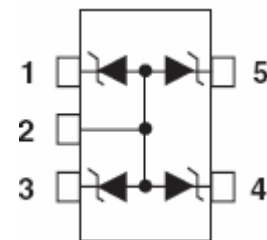
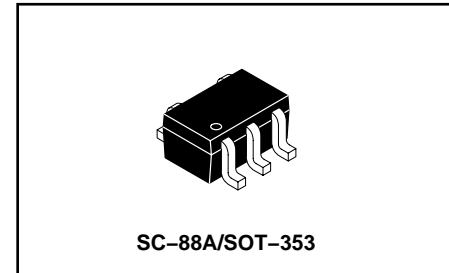

ORDERING INFORMATION

Device	Package	Shipping
LESDA6V8AW5T1G	SC-88A	3000/Tape & Reel

LESDA6V8AW5T1G

MAXIMUM RATINGS (T_A = 25°C unless otherwise noted)

Rating	Symbol	Value	Unit
Peak Power Dissipation 8 ± 20 μsec Double Exponential Waveform (Note 1)	P _{PK}	20	W
Steady State Power – 1 Diode (Note 2)	P _D	200	mW
Thermal Resistance – Junction-to-Ambient Above 25°C, Derate	R _{θJA}	327 3.05	°C/W mW/°C
Operating Junction Temperature Range	T _J	-40 to +125	°C
Storage Temperature Range	T _{stg}	-55 to +150	°C
Lead Solder Temperature – Maximum 10 Seconds Duration	T _L	260	°C

Maximum ratings are those values beyond which device damage can occur. Maximum ratings applied to the device are individual stress limit values (not normal operating conditions) and are not valid simultaneously. If these limits are exceeded, device functional operation is not implied, damage may occur and reliability may be affected.

1. Non-repetitive current pulse per Figure 1.
2. Only 1 diode under power. For all 4 diodes under power, P_D will be 25%. Mounted on FR4 board with min pad.

ELECTRICAL CHARACTERISTICS (T_A = 25°C unless otherwise noted)

Characteristic	Symbol	Min	Typ	Max	Unit
Breakdown Voltage (I _T = 1 mA) (Note 3)	V _{BR}	6.4	6.8	7.1	V
Leakage Current (V _{RWM} = 5.0 V)	I _R	–	–	1.0	μA
Clamping Voltage 1 (I _{PP} = 1.6 A, 8 ± 20 μsec Waveform)	V _C	–	–	13	V
Maximum Peak Pulse Current (8 ± 20 μsec Waveform)	I _{PP}	–	–	1.6	A
Junction Capacitance – (V _R = 0 V, f = 1 MHz) – (V _R = 3.0 V, f = 1 MHz)	C _J	–	12 6.7	15 9.5	pF

3. V_{BR} is measured at pulse test current I_T.

LESDA6V8AW5T1G

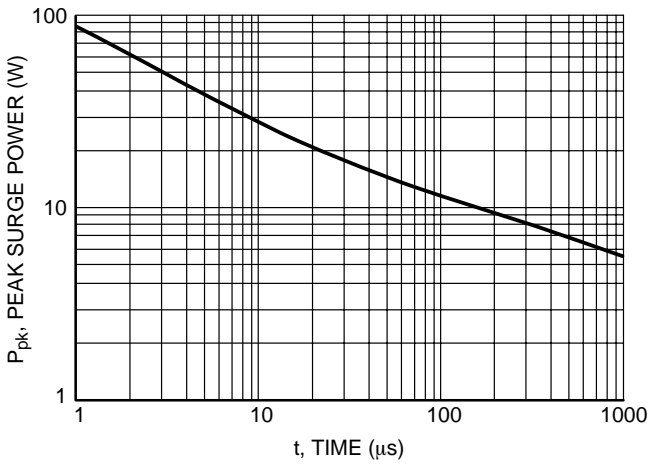

Figure 1. Pulse Width

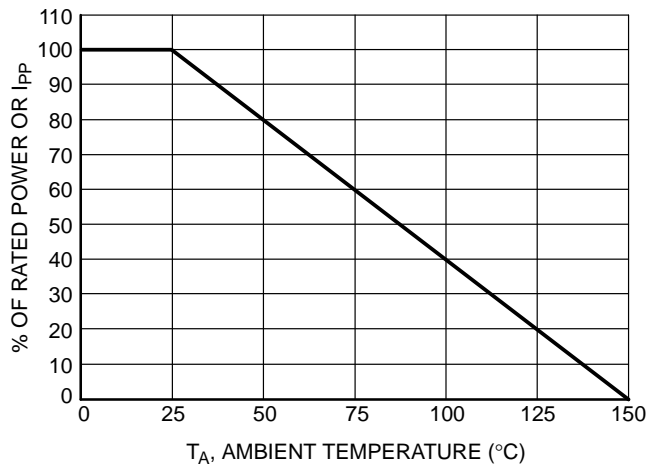

Figure 2. Power Derating Curve

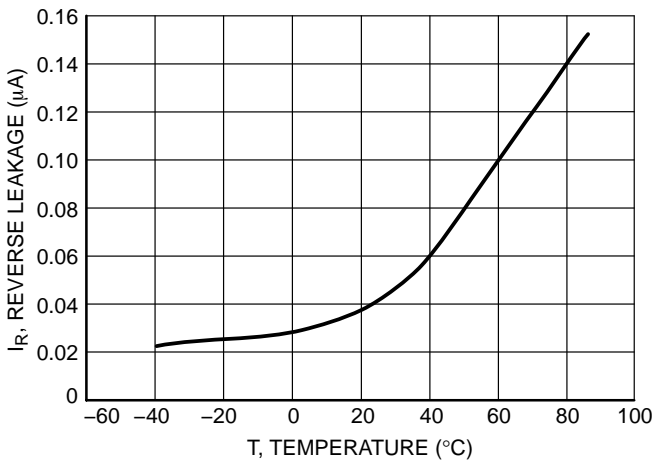

Figure 3. Reverse Leakage versus Temperature

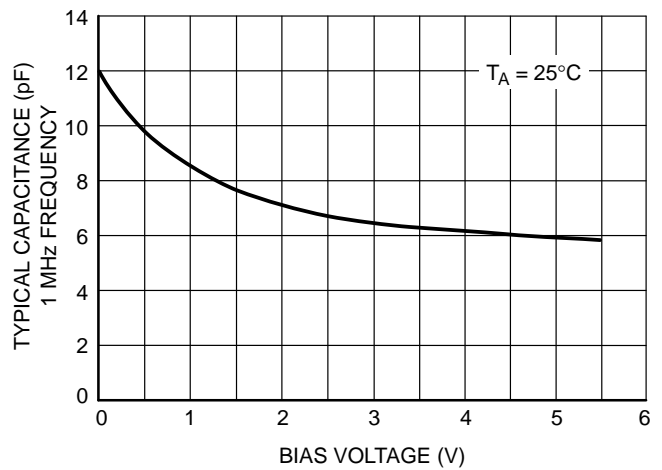

Figure 4. Capacitance

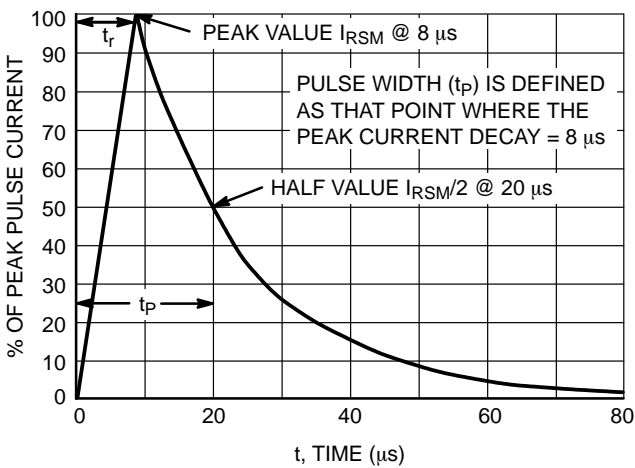

Figure 5. $8 \times 20 \mu s$ Pulse Waveform

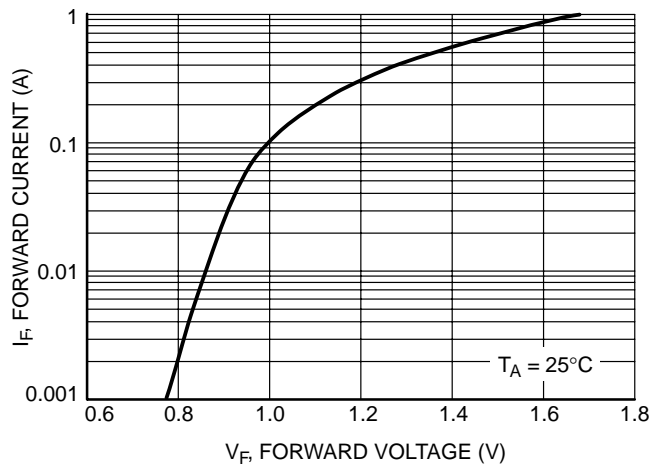
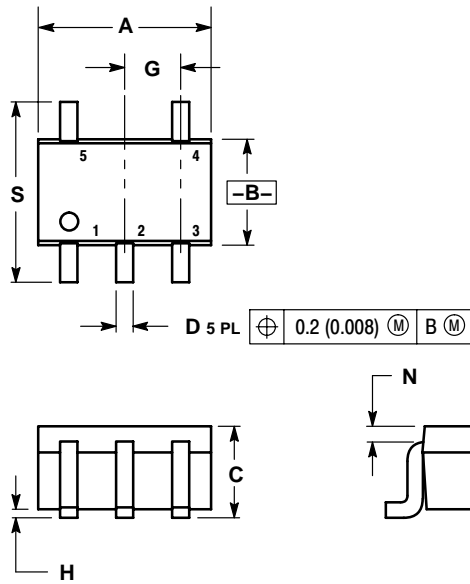

Figure 6. Forward Voltage

LESDA6V8AW5T1G

SC-88A/SOT-353



NOTES:

1. DIMENSIONING AND TOLERANCING PER ANSI Y14.5M, 1982.
2. CONTROLLING DIMENSION: INCH.
3. 419A-01 OBSOLETE. NEW STANDARD 419A-02.
4. DIMENSIONS A AND B DO NOT INCLUDE MOLD FLASH, PROTRUSIONS, OR GATE BURRS.

DIM	INCHES		MILLIMETERS	
	MIN	MAX	MIN	MAX
A	0.071	0.087	1.80	2.20
B	0.045	0.053	1.15	1.35
C	0.031	0.043	0.80	1.10
D	0.004	0.012	0.10	0.30
G	0.026 BSC		0.65 BSC	
H	---	0.004	---	0.10
J	0.004	0.010	0.10	0.25
K	0.004	0.012	0.10	0.30
N	0.008 REF		0.20 REF	
S	0.079	0.087	2.00	2.20

SOLDERING FOOTPRINT*

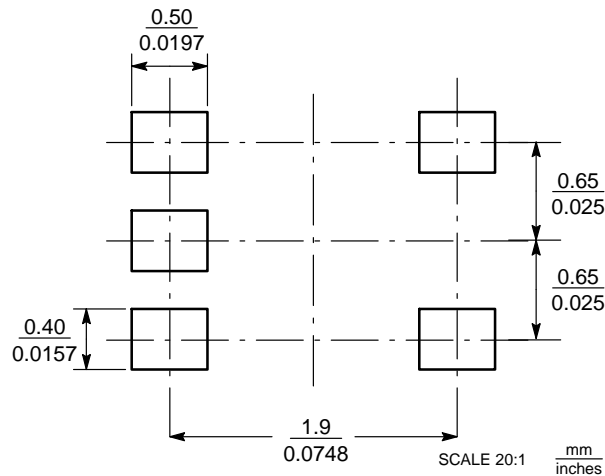

EMBOSSED TAPE AND REEL DATA FOR DISCRETES

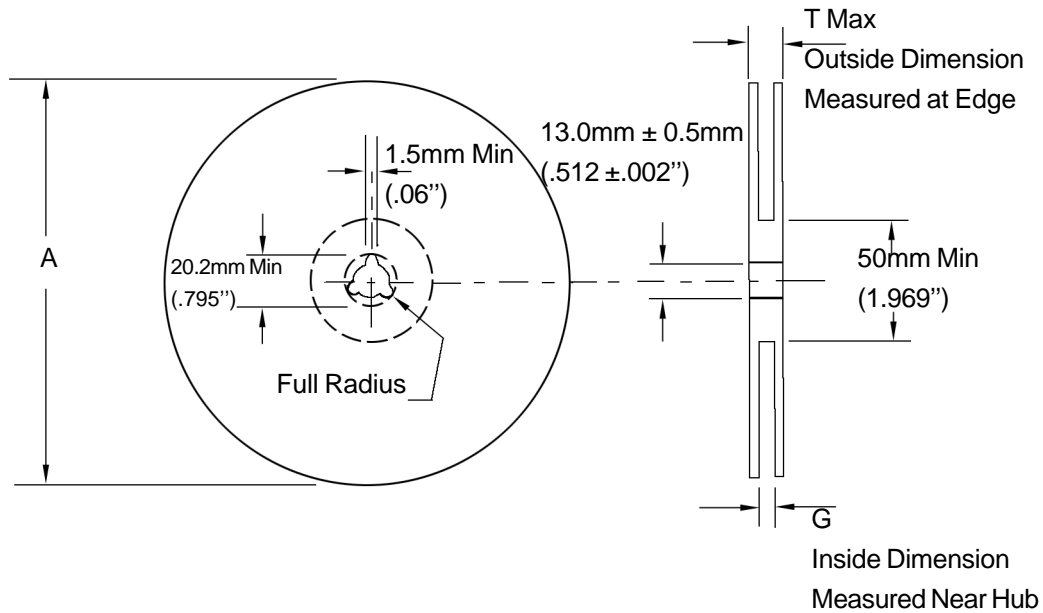

Size	A Max	G	T Max
8 mm	178.0mm (7.0")	8.4mm+1.5mm, -0.0 (.33"+.039", -0.00)	10.9mm (.43")

Reel Dimensions

Metric Dimensions Govern — English are in parentheses for reference only

Storage Conditions

Temperature: 5 to 40 Deg.C (20 to 30 Deg. C is preferred)

Humidity: 30 to 80 RH (40 to 60 is preferred)

Recommended Period: One year after manufacturing

(This recommended period is for the soldering condition only. The characteristics and reliabilities of the products are not restricted to this limitation)

Shipment Specification

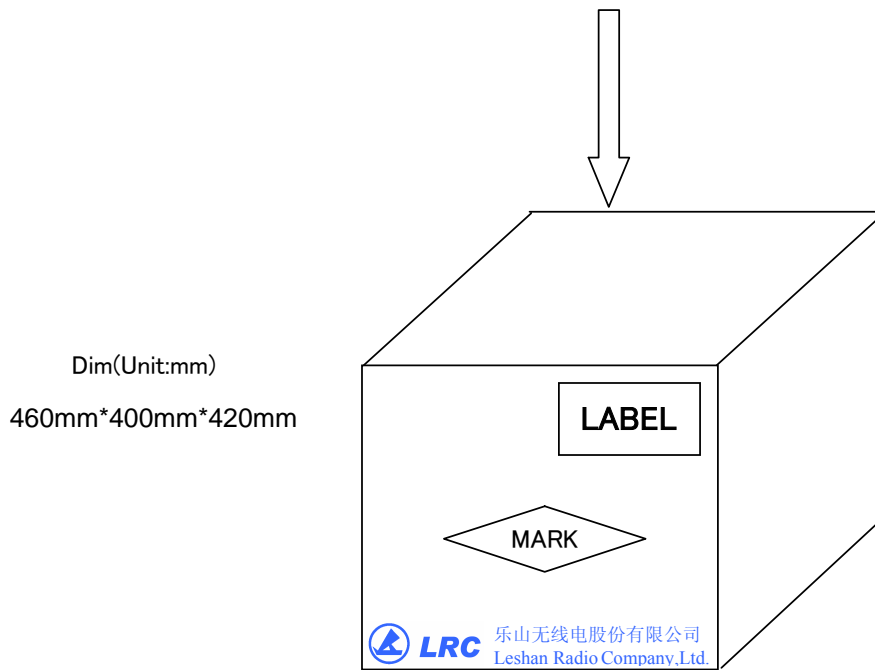
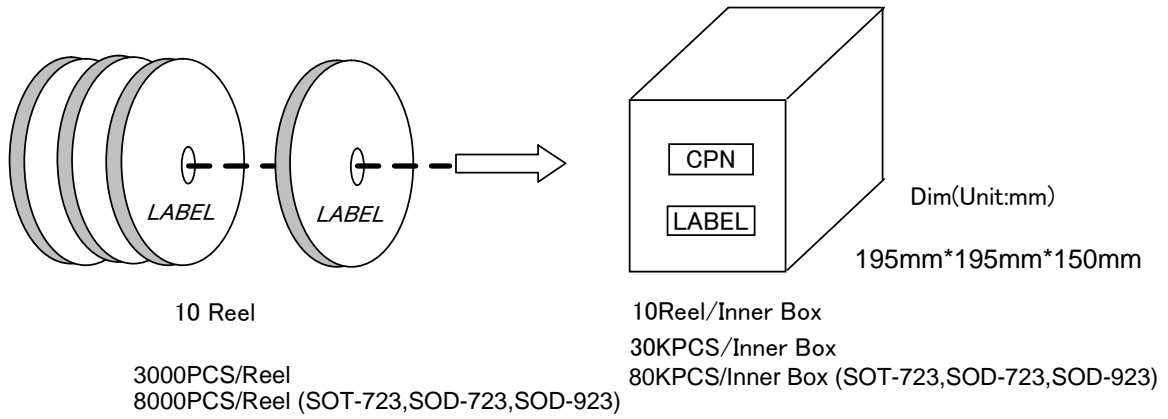

12 Inner Box/Carton

360KPCS/Carton
960KPCS/Carton (SOT-723,SOD-723,SOD-923)