

## Dual Precision JFET Input Operational Amplifiers

### FEATURES

- Internally Trimmed Offset Voltage      1mV Max.
- Offset Voltage Drift                      10 $\mu$ V/ $^{\circ}$ C Max.
- High Slew Rate                              10V/ $\mu$ s Min.
- Wide Bandwidth                            3.5MHz Min.
- Low Supply Current per Amplifier      1.8mA Typ.
- Low Input Bias Current                  10pA Typ.
- Standard 8-Pin Configuration
- All Packages Available:                  Metal Can  
Hermetic DIP  
Plastic DIP

### APPLICATIONS

- Sample and Hold Amplifiers
- Output Amplifier for Dual Current Output DACs
- High Speed Integrators
- Photocell Amplifiers
- High Input Impedance Instrumentation Amplifiers

### DESCRIPTION

Linear Technology's LF412A and OP-215 series of dual JFET input op amps feature several improvements compared to similar types from other manufacturers.

Both devices have lower input bias and offset currents over the entire temperature range, and are available in all standard 8-pin packages.

In addition, Linear's LF412A has lower voltage noise and higher voltage gain. Linear's OP-215 supply currents are nearly halved.

Please see the LT1057/LT1058 data sheet for applications requiring higher performance. The LT1057 is a pin compatible JFET input dual, the LT1058 is a JFET input quad op amp in the standard 14-pin DIP configuration.

2

**Slew Rate**

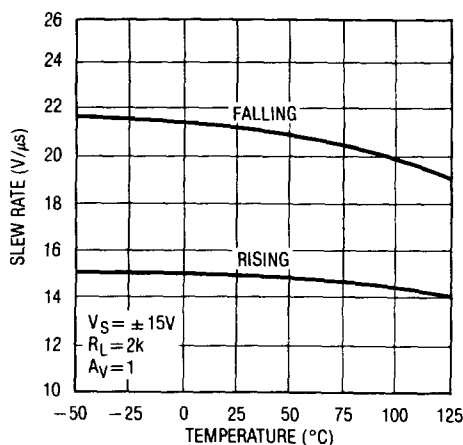

**Voltage Noise Density vs Frequency**

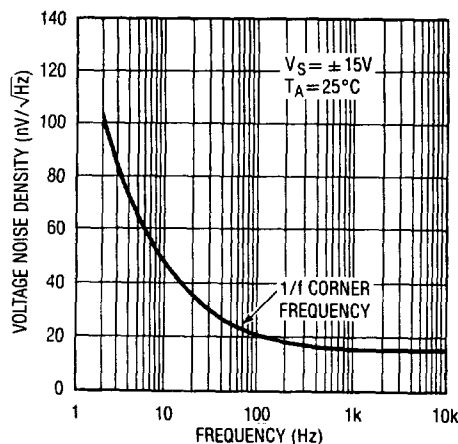

## ABSOLUTE MAXIMUM RATINGS

Supply Voltage  
 LF412AM/AC, OP-215A/E..... ± 22V  
 LF412M/C, OP-215C/G ..... ± 18V  
 Internal Power Dissipation ..... 670mW  
 Operating Temperature Range  
 LF412AM/M, OP-215A/C..... -55°C to 125°C  
 LF412AC/C, OP-215E/G ..... 0°C to 70°C  
 Differential Input Voltage  
 LF412AM/AC, OP-215A/E..... ± 40V  
 LF412M/C, OP-215C/G..... ± 30V  
 Input Voltage (Note A)  
 LF412AM/AC, OP-215A/E..... ± 20V  
 LF412M/C, OP-215C/G ..... ± 16V  
 Output Short Circuit Duration ..... Indefinite  
 Storage Temperature Range..... -65°C to 150°C  
 Lead Temperature (Soldering, 10 sec) ..... 300°C

**Note A:** Maximum negative input voltage is equal to the negative supply voltage.

## PACKAGE/ORDER INFORMATION

TOP VIEW	ORDER PART NUMBER
<p>H PACKAGE METAL CAN</p>	LF412AMH OP-215AH LF412MH OP-215CH LF412ACH OP-215EH LF412CH OP-215GH
<p>J8 PACKAGE HERMETIC DIP N8 PACKAGE PLASTIC DIP</p>	LF412AMJ8 OP-215AJ8 LF412MJ8 OP-215CJ8 LF412ACJ8 OP-215EJ8 LF412CJ8 OP-215GJ8 LF412ACN8 OP-215EN8 LF412CN8 OP-215GN8

## ELECTRICAL CHARACTERISTICS $V_S = \pm 20V$ for LF412A, $V_S = \pm 15V$ for all other grades. $V_{CM} = 0V$ , $T_A = 25^\circ C$ unless otherwise noted.

SYMBOL	PARAMETER	CONDITIONS	OP-215A/E			LF412AM/AC			LF412, OP-215C/G			UNITS
			MIN	TYP	MAX	MIN	TYP	MAX	MIN	TYP	MAX	
$V_{OS}$	Input Offset Voltage		—	0.2	1.0	—	0.3	1.0	—	0.5	3.0	mV
$I_{OS}$	Input Offset Current	$T_I = 25^\circ C$ (Note 1) Warmed-Up $V_S = \pm 15V$	—	6	50	—	6	50	—	10	100	pA
$I_B$	Input Bias Current	$T_I = 25^\circ C$ (Note 1) Warmed-Up $V_S = \pm 15V$	—	± 10	± 100	—	± 10	± 100	—	± 15	± 200	pA
			—	± 15	± 300	—	± 15	± 300	—	± 20	± 400	pA
$R_{IN}$	Input Resistance		—	$10^{12}$	—	—	$10^{12}$	—	—	$10^{12}$	—	$\Omega$
$A_{VOL}$	Large Signal Voltage Gain	$R_L \geq 2k\Omega$ , $V_O = \pm 10V$ $V_S = \pm 15V$	150	400	—	100	300	—	50	250	—	V/mV
$V_O$	Output Voltage Swing	$R_L = 10k\Omega$ , $V_S = \pm 15V$ $R_L = 2k\Omega$ , $V_S = \pm 15V$	± 12	± 13	—	± 12	± 13	—	± 12	± 13	—	V
			± 11	± 12.7	—	± 11	± 12.7	—	± 11	± 12.7	—	V
$I_S$	Supply Current		—	3.8	6.0	—	3.6	5.6	—	3.8	6.5	mA
SR	Slew Rate	$V_S = \pm 15V$	10	15	—	10	15	—	8	13	—	V/ $\mu s$
GBW	Gain Bandwidth Product	$V_S = \pm 15V$ (Note 2)	3.5	5.7	—	3.5	5.7	—	3.0	5.5	—	MHz
	Settling Time	to 0.01%	—	2.3	—	—	2.3	—	—	2.4	—	$\mu s$
		to 0.10%	—	1.1	—	—	1.1	—	—	1.2	—	$\mu s$
	Input Voltage Range		± 11	+ 14.5	—	± 16	+ 19.5	—	± 11	+ 14.5	—	V
				- 11.5	—		- 16.5	—		- 11.5	—	
CMRR	Common-Mode Rejection Ratio	$V_{CM} = \pm 16V$ $V_{CM} = \pm 11V$ $V_{CM} = \pm 10.5V$	—	—	—	80	100	—	—	—	—	dB
			78	100	—	—	—	—	72	100	—	dB
			86	100	—	—	—	—	82	100	—	dB
PSRR	Power Supply Rejection Ratio	$V_S = \pm 10V$ to $\pm 20V$ $V_S = \pm 10V$ to $\pm 18V$	—	—	—	80	100	—	—	—	—	dB
			86	100	—	—	—	—	80	100	—	dB
$e_n$	Input Noise Voltage Density	$f_o = 100Hz$ $f_o = 1000Hz$	—	20	—	—	20	—	—	20	—	nV/ $\sqrt{Hz}$
			—	15	—	—	15	—	—	15	—	nV/ $\sqrt{Hz}$
$i_n$	Input Noise Current Density	$f_o = 100Hz$ $f_o = 1000Hz$	—	0.01	—	—	0.01	—	—	0.01	—	pA/ $\sqrt{Hz}$
			—	0.01	—	—	0.01	—	—	0.01	—	pA/ $\sqrt{Hz}$
	Channel Separation	$f = 1Hz$ to $20kHz$	—	120	—	—	120	—	—	120	—	dB

**ELECTRICAL CHARACTERISTICS**  $V_S = \pm 20V$  for LF412A,  $V_S = \pm 15V$  for all other grades.  
 $V_{CM} = 0V$ ,  $-55^\circ C \leq T_A \leq 125^\circ C$  unless otherwise noted.

SYMBOL	PARAMETER	CONDITIONS	OP-215A			LF412AM			LF412M, OP-215C			UNITS	
			MIN	TYP	MAX	MIN	TYP	MAX	MIN	TYP	MAX		
$V_{OS}$	Input Offset Voltage	●	—	0.5	2.0	—	0.7	2.0	—	1.0	5.0	mV	
	Average Input Offset Voltage Drift	●	—	3	10	—	4	10	—	5	20	$\mu V/^\circ C$	
$I_{OS}$	Input Offset Current	$T_J = 125^\circ C$ (Note 1)	●	—	0.8	8	—	0.8	8	—	1.0	12	nA
		$T_A = 125^\circ C$ , Warmed-Up $V_S = \pm 15V$	●	—	1.2	14	—	1.2	14	—	1.5	22	nA
$I_B$	Input Bias Current	$T_J = 125^\circ C$ (Note 1)	●	—	$\pm 1.5$	$\pm 10$	—	$\pm 1.5$	$\pm 10$	—	$\pm 1.8$	$\pm 15$	nA
		$T_A = 125^\circ C$ , Warmed-Up $V_S = \pm 15V$	●	—	$\pm 2.2$	$\pm 18$	—	$\pm 2.2$	$\pm 18$	—	$\pm 2.7$	$\pm 28$	nA
	Input Voltage Range	OP-215	●	$\pm 10.3$	$+14.5$ $-11.5$	—	—	—	—	$\pm 10.3$	$+14.5$ $-11.5$	—	V
		LF412	●	—	—	—	$\pm 16$	$+19.5$ $-16.5$	—	$\pm 11$	$+14.5$ $-11.5$	—	V
CMRR	Common-Mode Rejection Ratio	$V_{CM} = \pm 16V$	●	—	—	—	80	100	—	—	—	—	dB
		$V_{CM} = \pm 11V$	●	—	—	—	—	—	—	70	100	—	dB
		$V_{CM} = \pm 10.3V$	●	82	100	—	—	—	—	80	100	—	dB
$I_S$	Supply Current	●	—	4.2	6.8	—	4.0	5.6	—	4.2	6.8	mA	
PSRR	Power Supply Rejection Ratio	$V_S = \pm 10V$ to $\pm 20V$	●	—	—	—	80	100	—	—	—	—	dB
		$V_S = \pm 10V$ to $\pm 16V$	●	80	100	—	—	—	—	78	100	—	dB
$A_{VOL}$	Large Signal Voltage Gain	$R_L \geq 2k\Omega$ , $V_O = \pm 10V$ $V_S = \pm 15V$	●	30	150	—	30	150	—	25	150	—	V/mV
$V_O$	Output Voltage Swing	$R_L \geq 10k\Omega$ , $V_S = \pm 15V$	●	$\pm 12$	$\pm 13$	—	$\pm 12$	$\pm 13$	—	$\pm 12$	$\pm 13$	—	V

2

**ELECTRICAL CHARACTERISTICS**  $V_S = \pm 20V$  for LF412A,  $V_S = \pm 15V$  for all other grades.  
 $V_{CM} = 0V$ ,  $0^\circ C \leq T_A \leq 70^\circ C$  unless otherwise noted.

SYMBOL	PARAMETER	CONDITIONS	OP-215E			LF412AC			LF412C, OP-215G			UNITS	
			MIN	TYP	MAX	MIN	TYP	MAX	MIN	TYP	MAX		
$V_{OS}$	Input Offset Voltage	●	—	0.4	1.65	—	0.5	1.45	—	0.7	3.9	mV	
	Average Input Offset Voltage Drift	●	—	3	15	—	4	10	—	5	20	$\mu V/^\circ C$	
$I_{OS}$	Input Offset Current	$T_J = 70^\circ C$ (Note 1)	●	—	0.06	0.45	—	0.06	0.45	—	0.08	0.65	nA
		$T_A = 70^\circ C$ , Warmed-Up $V_S = \pm 15V$	●	—	0.08	0.8	—	0.08	0.8	—	0.10	1.2	nA
$I_B$	Input Bias Current	$T_J = 70^\circ C$ (Note 1)	●	—	$\pm 0.12$	$\pm 0.7$	—	$\pm 0.12$	$\pm 0.7$	—	$\pm 0.14$	$\pm 0.9$	nA
		$T_A = 70^\circ C$ , Warmed-Up $V_S = \pm 15V$	●	—	$\pm 0.16$	$\pm 1.4$	—	$\pm 0.16$	$\pm 1.4$	—	$\pm 0.19$	$\pm 1.8$	nA
	Input Voltage Range	OP-215	●	$\pm 10.3$	$+14.5$ $-11.5$	—	—	—	—	$\pm 10.3$	$+14.5$ $-11.5$	—	V
		LF412	●	—	—	—	$\pm 16$	$+19.5$ $-11.5$	—	$\pm 11$	$+14.5$ $-11.5$	—	V
CMRR	Common-Mode Rejection Ratio	$V_{CM} = \pm 16V$	●	—	—	—	80	100	—	—	—	—	dB
		$V_{CM} = \pm 11V$	●	—	—	—	—	—	—	70	100	—	dB
		$V_{CM} = \pm 10.3V$	●	80	100	—	—	—	—	76	100	—	dB
$I_S$	Supply Current	●	—	4.0	6.8	—	3.8	5.6	—	4.0	6.8	mA	
PSRR	Power Supply Rejection Ratio	$V_S = \pm 10V$ to $\pm 20V$	●	—	—	—	80	100	—	—	—	—	dB
		$V_S = \pm 10V$ to $\pm 16V$	●	80	100	—	—	—	—	76	100	—	dB
$A_{VOL}$	Large Signal Voltage Gain	$R_L \geq 2k\Omega$ , $V_O = \pm 10V$ $V_S = \pm 15V$	●	50	180	—	50	180	—	35	180	—	V/mV
$V_O$	Output Voltage Swing	$R_L \geq 10k\Omega$ , $V_S = \pm 15V$	●	$\pm 12$	$\pm 13$	—	$\pm 12$	$\pm 13$	—	$\pm 12$	$\pm 13$	—	V

The ● denotes the specifications which apply over the full operating temperature range. The shaded electrical specifications indicate those parameters which have been improved or guaranteed test limits provided for the first time.

**Note 1:** Input bias and offset currents are specified for two different conditions. The T specification is with the junction at ambient temperature; the

warmed-up specification is with the device operating in a warmed-up condition at the ambient temperature specified.

**Note 2:** Gain-bandwidth product is not tested. It is guaranteed by design and by inference from the slew rate measurement.

**Note 3:** The LF412A is 100% tested to this specification. All other grades are sample tested.

## TYPICAL PERFORMANCE CHARACTERISTICS

**Open-Loop Frequency Response**

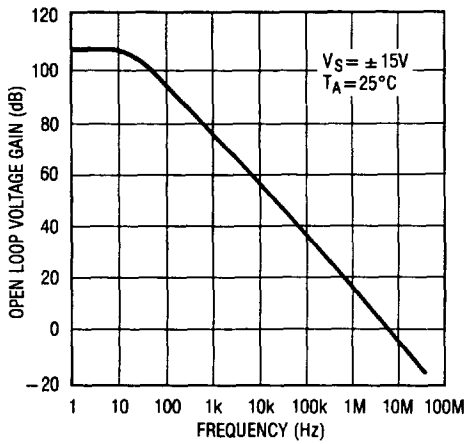

**Common-Mode Rejection Ratio vs Frequency**

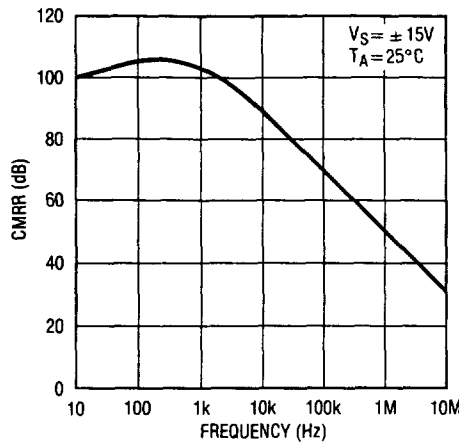

**Power Supply Rejection Ratio vs Frequency**

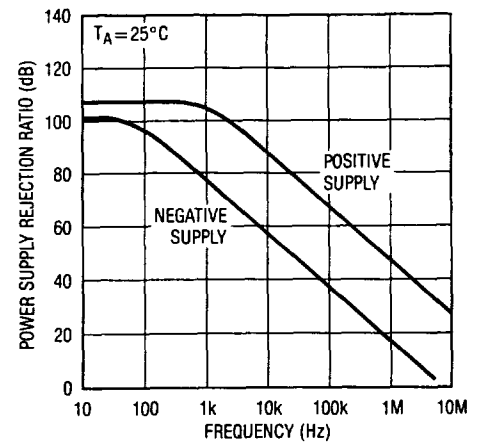

## PACKAGE DESCRIPTIONS Dimensions in inches (millimeters) unless otherwise noted.

**H Package  
TO-5 Metal Can**

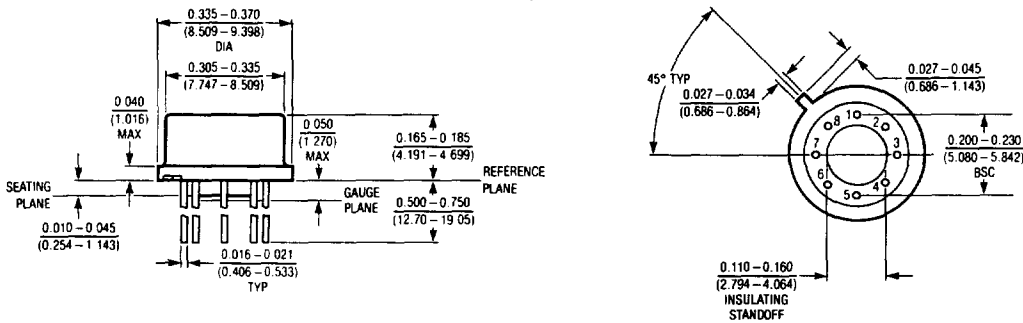

$T_{jmax}$	$\theta_{ja}$	$\theta_{jc}$
165°C	140°C/W	40°C/W

NOTE: LEAD DIAMETER IS UNCONTROLLED BETWEEN THE REFERENCE PLANE AND SEATING PLANE.

HS188

**J Package  
8 Lead Cerdip**

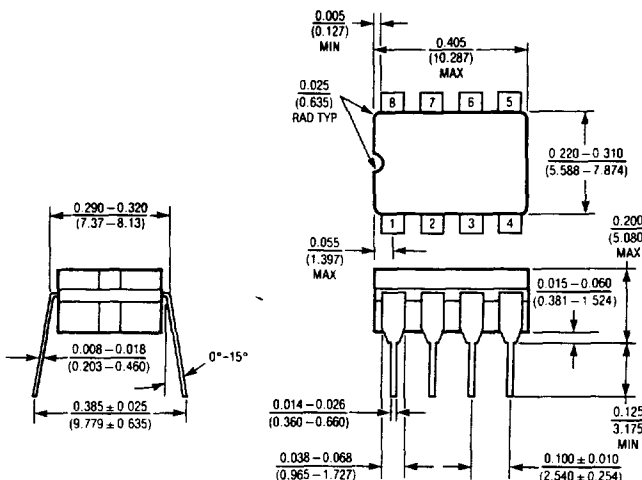

$T_{jmax}$	$\theta_{ja}$
155°C	100°C/W

JA188

**N Package  
8 Lead Molded Dip**

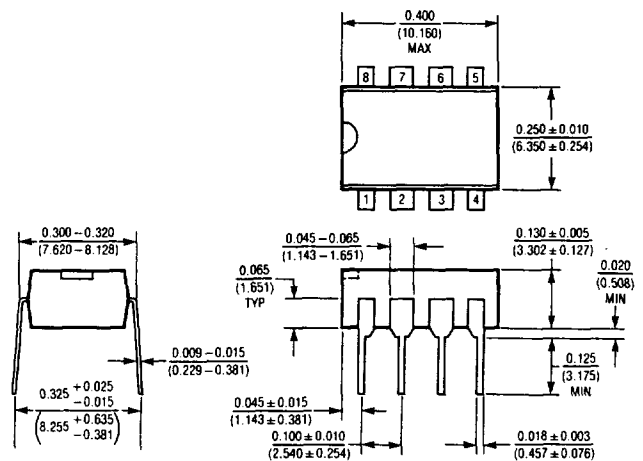

$T_{jmax}$	$\theta_{ja}$
115°C	130°C/W

HS188