

## LF451 Wide-Bandwidth JFET-Input Operational Amplifier

### General Description

The LF451 is a low-cost high-speed JFET-input operational amplifier with an internally trimmed input offset voltage (BI-FET II™ technology). The device requires a low supply current and yet maintains a large gain bandwidth product and a fast slew rate. In addition, well matched high voltage JFET input devices provide very low input bias and offset currents. The LF451 is pin compatible with the standard LM741, allowing designers to upgrade the overall performance of existing designs.

The LF451 may be used in such applications as high-speed integrators, fast D/A converters, sample-and-hold circuits and many other circuits requiring low input bias current, high input impedance, high slew rate and wide bandwidth.

### Features

- Internally trimmed offset voltage 5.0 mV (max)
- Low input bias current 50 pA (typ)
- Low input noise current 0.01 pA/√Hz (typ)
- Wide gain bandwidth 4 MHz (typ)
- High slew rate 13 V/μs (typ)
- Low supply current 3.4 mA (max)
- High input impedance 10<sup>12</sup>Ω (typ)
- Low total harmonic distortion  $A_V = 10$ ,  $R_L = 10k$ ,  $V_O = 20 V_{p-p}$ ,  $f = 20 \text{ Hz} - 20 \text{ kHz}$  <0.02% (typ)
- Low 1/f noise corner 50 Hz (typ)
- Fast settling time to 0.01% 2 μs (typ)

### Connection Diagram

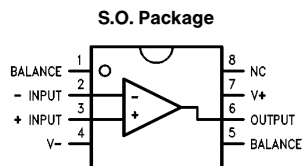

Top View  
Order Number LF451CM  
See NS Package Number M08A

TL/H/9660-2

### Typical Connection

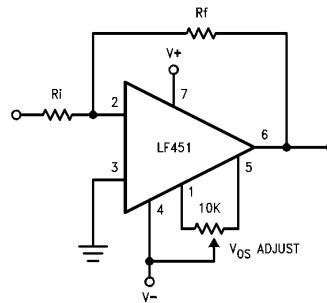

TL/H/9660-1

### Simplified Schematic

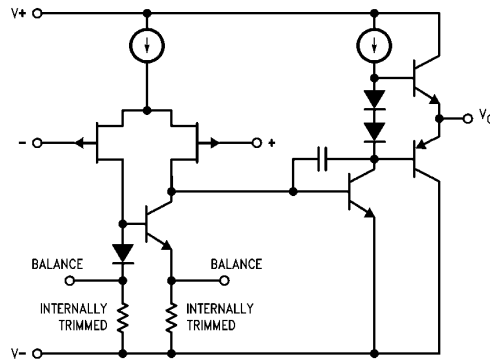

TL/H/9660-3

BI-FET™ is a trademark of National Semiconductor Corporation.

## Absolute Maximum Ratings (Note 1)

If Military/Aerospace specified devices are required, please contact the National Semiconductor Sales Office/Distributors for availability and specifications.

Supply Voltage ( $V^+ - V^-$ )	36V
Input Voltage Range	$V^- \leq V_{IN} \leq V^+$
Differential Input Voltage (Note 2)	$\pm 30V$
Junction Temperature ( $T_J$ MAX)	150°C
Output Short Circuit Duration	Continuous
Power Dissipation (Note 3)	500 mW

ESD Tolerance	TBD
Soldering Information (Note 5)	
SO Package: Vapor Phase (60 sec)	215°C
Infrared (15 sec)	220°C

## Operating Ratings (Note 1)

Temperature Range	$T_{MIN} \leq T_A \leq T_{MAX}$
LF451CM	$0^\circ C \leq T_A \leq +70^\circ C$
Junction Temperature ( $T_{Jmax}$ )	125°C
Supply Voltage ( $V^+ - V^-$ )	10V to 32V

**DC Electrical Characteristics** The following specifications apply for  $V^+ = +15V$  and  $V^- = -15V$ . **Bold-face limits apply for  $T_{MIN}$  to  $T_{MAX}$** ; all other limits  $T_A = T_J = 25^\circ C$ .

Symbol	Parameter	Conditions	LF451CM			Units
			Typical (Note 6)	Tested Limit (Note 7)	Design Limit (Note 8)	
$V_{OS}$	Maximum Input Offset Voltage	$R_S = 10\text{ k}\Omega$ , (Note 10)	0.3	5		mV
$I_{OS}$	Maximum Input Offset Current	(Notes 9, 10) $T_J = 25^\circ C$ $T_J = 70^\circ C$	25	100	<b>2</b>	pA nA
$I_B$	Maximum Input Bias Current	(Notes 9, 10) $T_J = 25^\circ C$ $T_J = 70^\circ C$	50	200	<b>4</b>	pA nA
$R_{IN}$	Input Resistance	$T_J = 25^\circ C$	10 <sup>12</sup>			$\Omega$
AVOL	Minimum Large Signal Voltage Gain	$V_O = \pm 10V$ , $R_L = 2\text{ k}\Omega$ (Note 10)	200	50	<b>25</b>	V/mV
$V_O$	Minimum Output Voltage Swing	$R_L = 10k$	$\pm 13.5$	$\pm 12$	$\pm 12$	V
$V_{CM}$	Minimum Input Common Mode Voltage Range		+14.5 -11.5	+11 -11	+11 -11	V V
CMRR	Minimum Common-Mode Rejection Ratio	$R_S \leq 10\text{ k}\Omega$	100	80	<b>80</b>	dB
PSRR	Minimum Supply Voltage Rejection Ratio	(Note 11)	100	80	<b>80</b>	dB
$I_S$	Maximum Supply Current			3.4	<b>3.4</b>	mA

**AC Electrical Characteristics** The following specifications apply for  $V^+ = +15V$  and  $V^- = -15V$ . **Bold-face limits apply for  $T_{MIN}$  to  $T_{MAX}$** ; all other limits  $T_A = T_J = 25^\circ C$ .

Symbol	Parameter	Conditions	LF451CM			Units
			Typical (Note 6)	Tested Limit (Note 7)	Design Limit (Note 8)	
SR	Slew Rate	$A_V = +1$	13	8		V/ $\mu s$
GBW	Minimum Gain-Bandwidth Product	$f = 100\text{ kHz}$	4	2.7		MHz
$e_n$	Equivalent Input Noise Voltage	$R_S = 100\Omega$ , $f = 1\text{ kHz}$	25			nV/ $\sqrt{Hz}$
$i_n$	Equivalent Input Noise Current	$R_S = 100\Omega$ , $f = 1\text{ kHz}$	0.01			pA/ $\sqrt{Hz}$

**Note 1:** Absolute Maximum Ratings indicate limits beyond which damage to the device may occur. DC and AC electrical specifications do not apply when operating the device beyond its specified operating ratings.

**Note 2:** When the input voltage exceeds the power supplies, the current should be limited to 1 mA.

**Note 3:** The maximum power dissipation must be derated at elevated temperatures and is dictated by  $T_J$  MAX,  $\theta_{JA}$  and the ambient temperature,  $T_A$ . The maximum allowable power dissipation at any temperature is  $P_D = (T_J \text{ MAX} - T_A)/\theta_{JA}$  or the number given in the Absolute Maximum Ratings, whichever is lower. For guaranteed operation  $T_{Jmax} = 125^\circ C$ . The typical thermal resistance ( $\theta_{JA}$ ) of the LF451CM when board-mounted is 170°C/W.

**Note 5:** See AN-450 "Surface Mounting Methods and Their Effect on Product Reliability" (Appendix D) for other methods of soldering surface mount devices.

**Note 6:** Typical values are at  $T_J = 25^\circ C$  and represent most likely parametric norm.

**Note 7:** Tested limits are guaranteed to National's AOQL (Average Outgoing Quality Level).

**Note 8:** Design limits are guaranteed to National's AOQL, but not 100% tested.

**Note 9:** The input bias currents are junction leakage currents which approximately double for every 10°C increase in the junction temperature  $T_J$ . Due to limited production test time, the input bias currents are correlated to junction temperature. In normal operation the junction temperature rises above the ambient temperature as a result of internal power dissipation,  $P_D$ .  $T_J = T_A + \theta_{JA}P_D$  where  $\theta_{JA}$  is the thermal resistance from junction to ambient.

**Note 10:**  $V_{OS}$ ,  $I_B$ ,  $AVOL$ , and  $I_{OS}$  are measured at  $V_{CM} = 0V$ .

**Note 11:** Supply voltage rejection ratio is measured for both supply magnitudes increasing or decreasing simultaneously in accordance with common practice.

## Typical Performance Characteristics

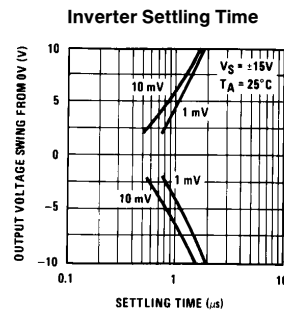
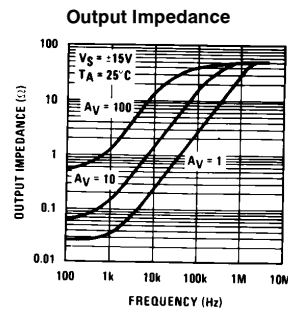
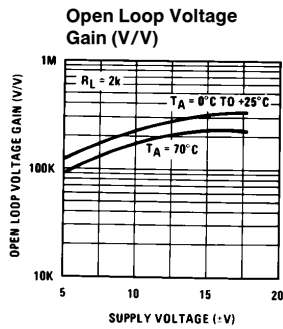
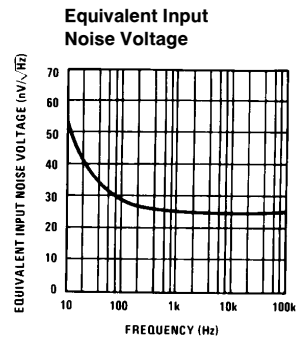
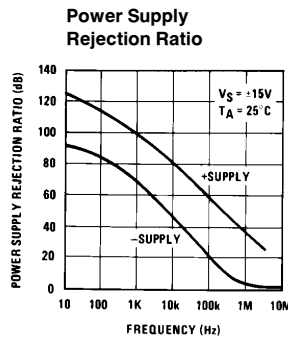
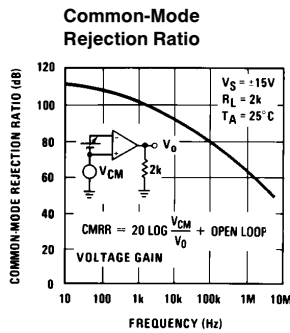
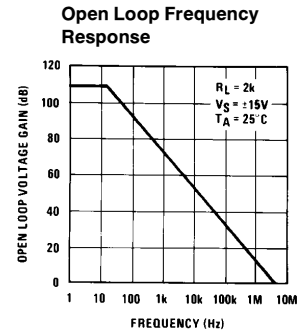
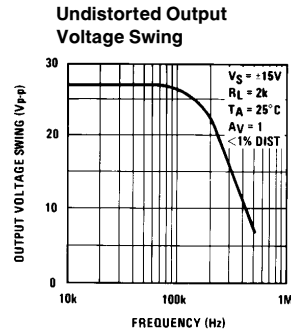
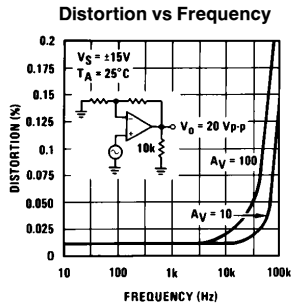

TL/H/9660-5

# Typical Performance Characteristics (Continued)

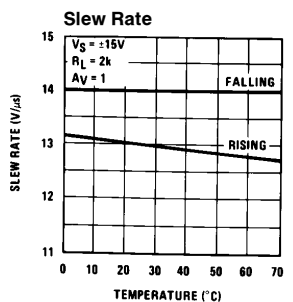
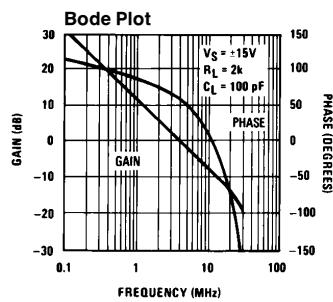
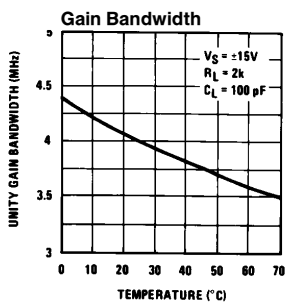
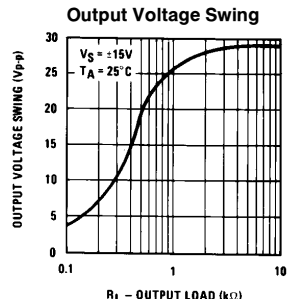
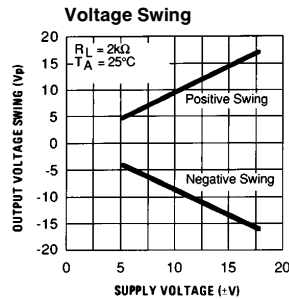
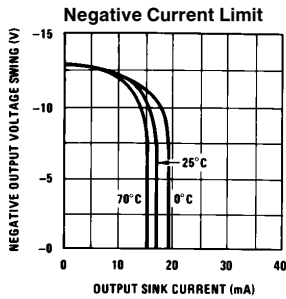
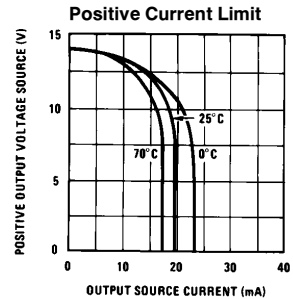
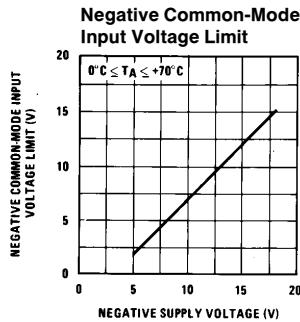
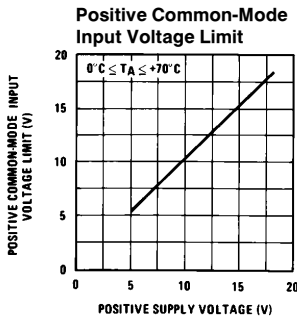
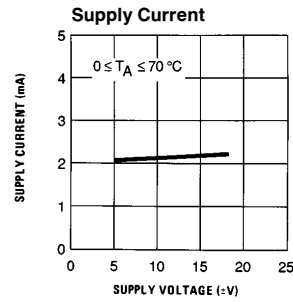
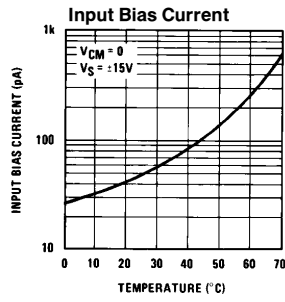
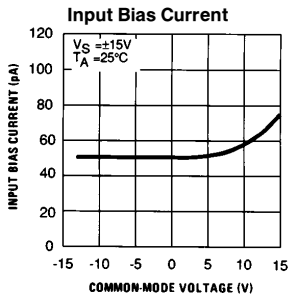

TL/H/9660-4

## Pulse Response

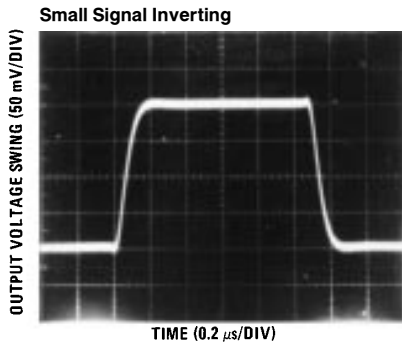

TL/H/9660-6

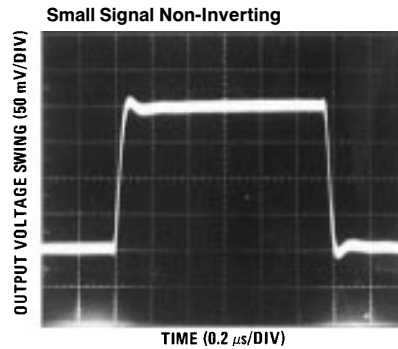

TL/H/9660-7

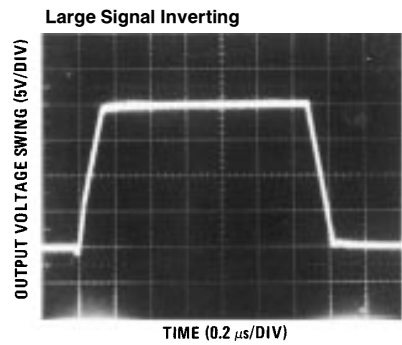

TL/H/9660-8

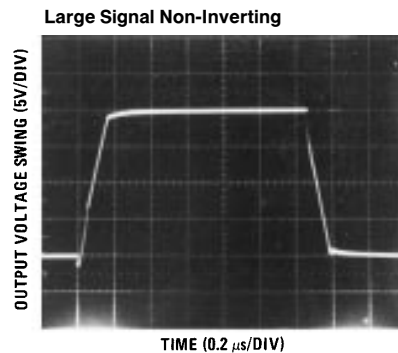

TL/H/9660-9

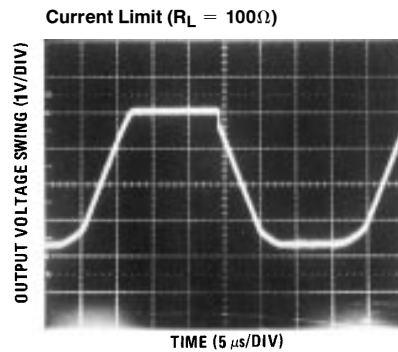

TL/H/9660-10

## Application Hints

The LF451CM is an op amp with an internally trimmed input offset voltage and JFET input devices (BI-FET II). These JFETs have large reverse breakdown voltages from gate to source and drain eliminating the need for clamps across the inputs. Therefore, large differential input voltages can easily be accommodated without a large increase in input current. The maximum differential input voltage is independent of the supply voltages. However, neither of the input voltages should be allowed to exceed the negative supply as this will

cause large currents to flow which can result in a destroyed unit.

Exceeding the negative common-mode limit with the non-inverting input, or with both inputs, will force the output to a high state, potentially causing a reversal of phase to the output.

In neither case does a latch occur since raising the input back within the common-mode range again puts the input stage and thus the amplifier in a normal operating mode.

## Application Hints (Continued)

Exceeding the positive common-mode limit on a single input will not change the phase of the output; however, if both inputs exceed the limit, the output of the amplifier will be forced to a high state.

The amplifier will operate with a common-mode input voltage equal to the positive supply; however, the gain bandwidth and slew rate may be decreased in this condition. When the negative common-mode voltage swings to within 3V of the negative supply, an increase in input offset voltage may occur.

The LF451 is biased by a zener reference which allows normal circuit operation on  $\pm 4V$  power supplies. Supply voltages less than these may result in lower gain bandwidth and slew rate.

The LF451 will drive a  $2\text{ k}\Omega$  load resistance to  $\pm 10V$  over the full temperature range of  $0^\circ\text{C}$  to  $+70^\circ\text{C}$ . If the amplifier is forced to drive heavier load currents, however, an increase in input offset voltage may occur on the negative voltage swing and finally reach an active current limit on both positive and negative swings.

Precautions should be taken to ensure that the power supply for the integrated circuit never becomes reversed in polarity or that the unit is not inadvertently installed backwards in a socket as an unlimited current surge through the resulting forward diode within the IC could cause fusing of the internal conductors and result in a destroyed unit.

As with most amplifiers, care should be taken with lead dress, component placement and supply decoupling in order to ensure stability. For example, resistors from the output to an input should be placed with the body close to the

input to minimize "pick-up" and maximize the frequency of the feedback pole by minimizing the capacitance from the input to ground.

A feedback pole is created when the feedback around any amplifier is resistive. The parallel resistance and capacitance from the input of the device (usually the inverting input) to AC ground set the frequency of the pole. In many instances the frequency of this pole is much greater than the expected 3 dB frequency of the closed loop gain and consequently there is negligible effect on stability margin. However, if the feedback pole is less than approximately 6 times the expected 3 dB frequency a lead capacitor should be placed from the output to the input of the op amp. The value of the added capacitor should be such that the RC time constant of this capacitor and the resistance it parallels is greater than or equal to the original feedback pole time constant.

The benefit of the S.O. package results from its very small size. It follows, however, that the die inside the S.O. package is less protected from external physical forces than a die in a standard DIP would be, because there is so much less plastic in the S.O. Therefore, not following certain precautions when board mounting the LF451CM can put mechanical stress on the die, lead frame, and/or bond wires. This can cause shifts in the LF451CM's parameters, even causing them to exceed limits specified in the Electrical Characteristics. For recommended practices in LF451CM surface mounting refer to Application Note AN-450 "Surface Mounting Methods and Their Effect on Product Reliability" and to Section 6 "Surface Mount" found in any Rev. 1 Linear Databook volume.

## Detailed Schematic

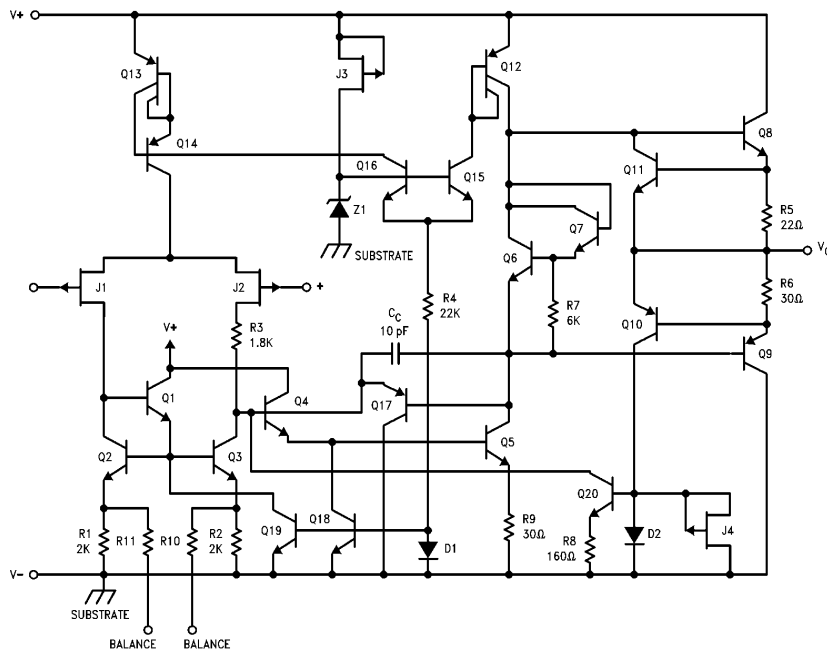

TL/H/9660-11



**Physical Dimensions** inches (millimeters)

Lit. # 106161

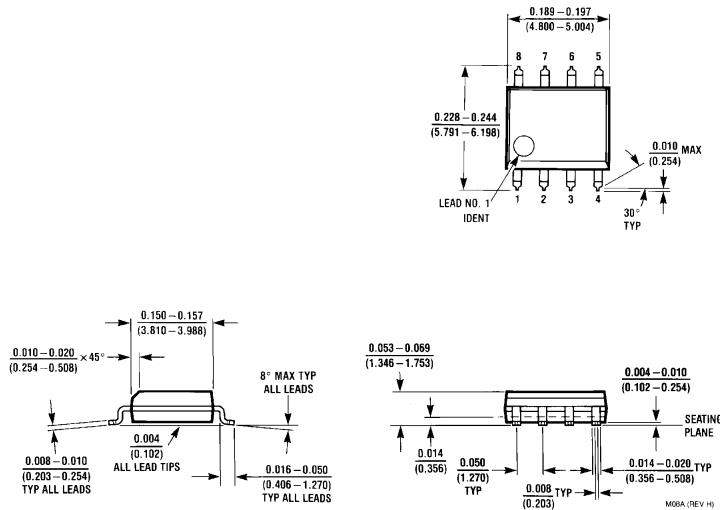

**Small Outline Package (M)  
Order Number LF451CM  
NS Package Number M08A**

**LIFE SUPPORT POLICY**

NATIONAL'S PRODUCTS ARE NOT AUTHORIZED FOR USE AS CRITICAL COMPONENTS IN LIFE SUPPORT DEVICES OR SYSTEMS WITHOUT THE EXPRESS WRITTEN APPROVAL OF THE PRESIDENT OF NATIONAL SEMICONDUCTOR CORPORATION. As used herein:

1. Life support devices or systems are devices or systems which, (a) are intended for surgical implant into the body, or (b) support or sustain life, and whose failure to perform, when properly used in accordance with instructions for use provided in the labeling, can be reasonably expected to result in a significant injury to the user.
2. A critical component is any component of a life support device or system whose failure to perform can be reasonably expected to cause the failure of the life support device or system, or to affect its safety or effectiveness.



**National Semiconductor Corporation**  
1111 West Bardin Road  
Arlington, TX 76017  
Tel: 1(800) 272-9959  
Fax: 1(800) 737-7018

**National Semiconductor Europe**  
Fax: (+49) 0-180-530 85 86  
Email: cnjwge@tevm2.nsc.com  
Deutsch Tel: (+49) 0-180-530 85 85  
English Tel: (+49) 0-180-532 78 32  
Français Tel: (+49) 0-180-532 93 58  
Italiano Tel: (+49) 0-180-534 16 80

**National Semiconductor Hong Kong Ltd.**  
19th Floor, Straight Block,  
Ocean Centre, 5 Canton Rd.  
Tsimshatsui, Kowloon  
Hong Kong  
Tel: (852) 2737-1600  
Fax: (852) 2736-9960

**National Semiconductor Japan Ltd.**  
Tel: 81-043-299-2309  
Fax: 81-043-299-2408

National does not assume any responsibility for use of any circuitry described, no circuit patent licenses are implied and National reserves the right at any time without notice to change said circuitry and specifications.