

Ceramic Low Pass Filter

LFCN-2752+

50Ω DC to 27500 MHz



Generic photo used for illustration purposes only
CASE STYLE: FV1206-11

The Big Deal

- Good rejection, 40 dB typical
- Rugged, ceramic construction
- Small size, 3.2mm X 1.6mm (1206)
- LTCC Low pass filter at mm wave frequency

Product Overview

Mini-Circuits' LFCN-2752+ is an LTCC low pass filter with a passband from DC to 27500 MHz, supporting a variety of applications. This model provides 1.5 dB typical passband insertion loss and provides a very good stopband rejection due to strategically constructed layout with minimal interaction between components. It handles up to 1W RF input power and provides a wide operating temperature range from -55 to +125°C. Housed in a small 1206 ceramic form factor, the filter is ideal for dense PCB layouts and with minimal performance variation due to parasitics.

Key Features

Feature	Advantages
Ultra-wide stopband	The LTCC lowpass filter provides a very good stopband rejection until 46 GHz suitable for high end applications.
LTCC Construction	Provides repeatable performance in a rugged, ceramic package well suited for tough environments such as high humidity and temperature extremes.
Small size 3.2mm X 1.6mm (1206)	Saves space in dense circuit board layouts and minimizes the effects of parasitics.

Notes

- A. Performance and quality attributes and conditions not expressly stated in this specification document are intended to be excluded and do not form a part of this specification document.
B. Electrical specifications and performance data contained in this specification document are based on Mini-Circuit's applicable established test performance criteria and measurement instructions.
C. The parts covered by this specification document are subject to Mini-Circuits standard limited warranty and terms and conditions (collectively, "Standard Terms"); Purchasers of this part are entitled to the rights and benefits contained therein. For a full statement of the Standard Terms and the exclusive rights and remedies thereunder, please visit Mini-Circuits' website at www.minicircuits.com/MCLStore/terms.jsp



Low Pass Filter

LFCN-2752+

50Ω DC to 27500 MHz



Generic photo used for illustration purposes only
CASE STYLE: FV1206-11

+RoHS Compliant
The +Suffix identifies RoHS Compliance. See our web site for RoHS Compliance methodologies and qualifications

Features

- Low loss, 1.5 dB typical
- Good rejection 40 dB typical
- Good power handling, 1W
- Small size 3.2mm X 1.6mm (1206)
- Temperature stable
- LTCC construction

Applications

- 5G applications

Functional Schematic

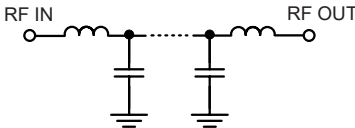

Electrical Specifications^{1,2} at 25°C

Parameter		F#	Frequency (MHz)	Min.	Typ.	Max.	Unit
Pass Band	Insertion Loss	DC-F1	DC - 17000	—	0.6	1.0	dB
		F1-F2	17000 - 25500	—	1.0	1.8	dB
	Frequency Cut-off	F2-F3	25500 - 27500	—	1.5	—	dB
		F4	29500	—	3	—	dB
Stop Band	Return Loss	DC-F3	DC - 27500	—	12	—	dB
		F5-F6	34500 - 39000	19	30	—	dB
	Rejection Loss	F6-F7	39000 - 45000	29	40	—	dB
		F7-F8	45000 - 46000	—	42	—	dB

1 DC de-coupling capacitors are required in Applications where DC voltage and/or current is present at either input or output ports. Please contact Mini-Circuits for alternatives if DC pass from IN-OUT is required.

2 Measured on Mini-Circuits Characterization Test Board TB-LFCN-2752C+

Maximum Ratings

Operating Temperature	-55°C to 125°C
Storage Temperature	-55°C to 125°C
RF Power Input*	1W max. @25°C

Permanent damage may occur if any of these limits are exceeded.

Typical Performance Data at 25°C

Frequency (MHz)	Insertion Loss (dB)	Return Loss (dB)
10	0.01	42.56
100	0.02	35.35
500	0.02	26.42
1000	0.04	24.26
5000	0.07	38.21
10000	0.19	21.80
17000	0.19	32.82
25500	0.71	20.31
27500	1.05	19.85
29500	3.09	12.10
31000	12.67	4.49
31800	20.85	5.35
32500	30.10	4.17
34500	29.38	3.43
39000	46.63	2.68
40000	43.07	2.78
42000	41.42	3.15
44000	44.48	2.99
45000	47.73	3.70
46000	47.10	3.34

Typical Frequency Response

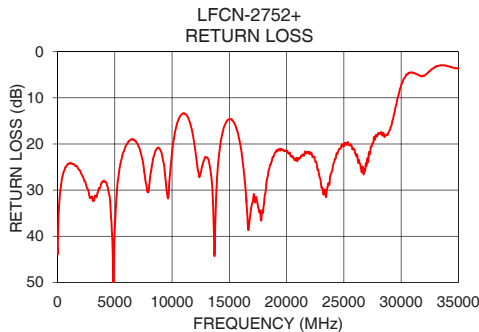
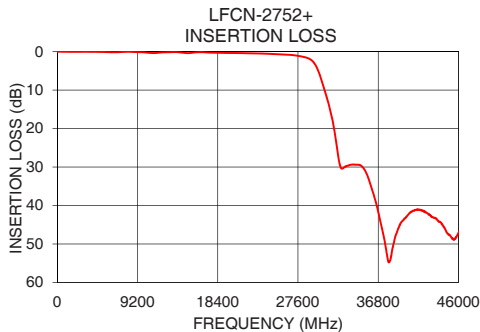
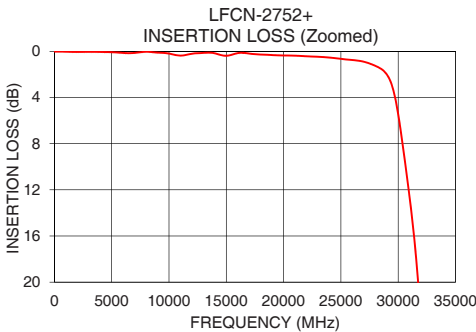
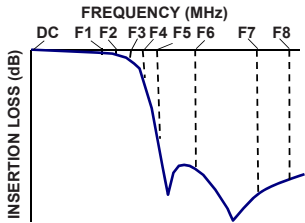

Notes

- A. Performance and quality attributes and conditions not expressly stated in this specification document are intended to be excluded and do not form a part of this specification document.
- B. Electrical specifications and performance data contained in this specification document are based on Mini-Circuit's applicable established test performance criteria and measurement instructions.
- C. The parts covered by this specification document are subject to Mini-Circuits standard limited warranty and terms and conditions (collectively, "Standard Terms"); Purchasers of this part are entitled to the rights and benefits contained therein. For a full statement of the Standard Terms and the exclusive rights and remedies thereunder, please visit Mini-Circuits' website at www.minicircuits.com/MCLStore/terms.jsp



Pad Connections

INPUT	1
OUTPUT	2
GROUND	3

Product Marking: LW

Demo Board MCL P/N: TB-LFCN-2752C+
Suggested PCB Layout (PL-702)

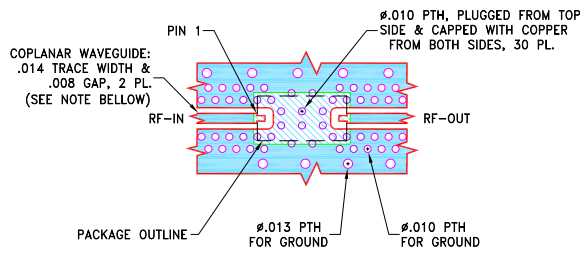

NOTES:

- TRACE WIDTH & GAP PARAMETERS ARE SHOWN FOR MEGTRON-7 R5785(N); DIELECTRIC THICKNESS: .0079±.001; COPPER: HVLP/HVLP, 1/2 Oz EACH SIDE. FOR OTHER MATERIALS TRACE WIDTH & GAP MAY NEED TO BE MODIFIED.
- BOTTOM SIDE OF THE PCB IS CONTINUOUS GROUND PLANE.

- DENOTES PCB COPPER LAYOUT WITH SMOBC (SOLDER MASK OVER BARE COPPER).
- DENOTES COPPER LAND PATTERN FREE OF SOLDER MASK.

Outline Drawing

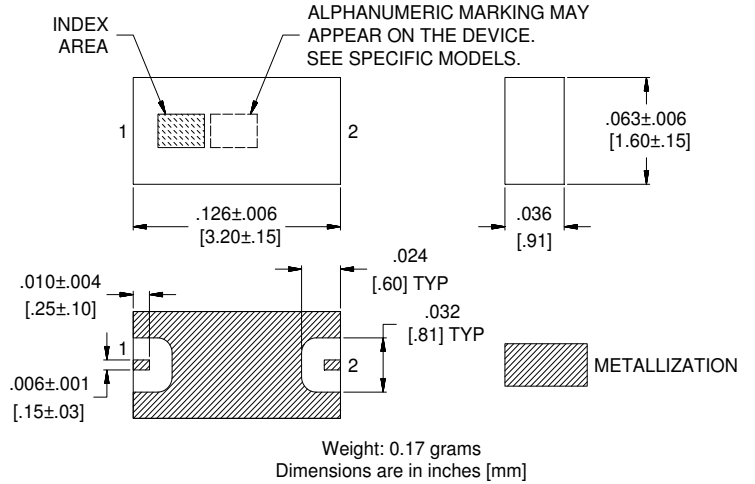

Notes

- Performance and quality attributes and conditions not expressly stated in this specification document are intended to be excluded and do not form a part of this specification document.
- Electrical specifications and performance data contained in this specification document are based on Mini-Circuit's applicable established test performance criteria and measurement instructions.
- The parts covered by this specification document are subject to Mini-Circuits standard limited warranty and terms and conditions (collectively, "Standard Terms"); Purchasers of this part are entitled to the rights and benefits contained therein. For a full statement of the Standard Terms and the exclusive rights and remedies thereunder, please visit Mini-Circuits' website at www.minicircuits.com/MCLStore/terms.jsp