

# Ceramic Low Pass Filter

50Ω DC<sup>(1)</sup> to 400 MHz

## LFCN-400+



CASE STYLE: FV1206

### Maximum Ratings

Operating Temperature	-55°C to 100°C
Storage Temperature	-55°C to 100°C
RF Power Input*	8.5W max. at 25°C

\* Passband rating, derate linearly to 3.5W at 100°C ambient. Permanent damage may occur if any of these limits are exceeded.

### Pin Connections

RF IN	1
RF OUT	3
GROUND	2,4

### Outline Drawing

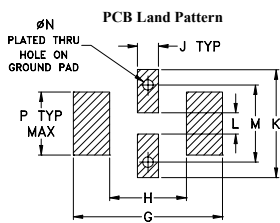
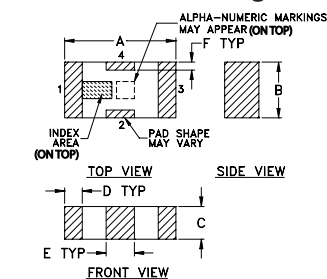

Suggested Layout, Tolerance to be within ±.002

### Outline Dimensions (inch/mm)

A	B	C	D	E	F	G	
.126	.063	.037	.020	.032	.009	.169	
3.20	1.60	0.94	0.51	0.81	0.23	4.29	
H	J	K	L	M	N	P	wt
.087	.024	.122	.024	.087	.012	.071	grams
2.21	0.61	3.10	0.61	2.21	0.30	1.80	.020

### Demo Board MCL P/N: TB-270 Suggested PCB Layout (PL-137)

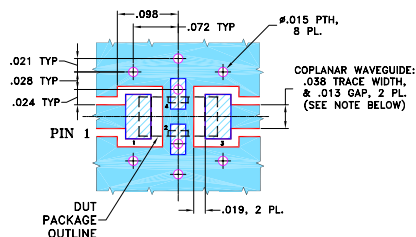

- NOTES: 1. COPLANAR WAVEGUIDE PARAMETERS ARE SHOWN FOR ROGERS RO4350B WITH THICKNESS .020" ± .0015". COPPER: 1/2 OZ. EACH SIDE. FOR OTHER MATERIALS TRACE WIDTH & GAP MAY NEED TO BE MODIFIED.
2. BOTTOM SIDE OF THE PCB IS CONTINUOUS GROUND PLANE.
- DENOTES PCB COPPER LAYOUT WITH SMOBC (SOLDER MASK OVER BARE COPPER)
  - DENOTES COPPER LAND PATTERN FREE OF SOLDER MASK

### Features

- excellent power handling, 8.5W
- small size
- 7 sections
- temperature stable
- LTCC construction
- protected by U.S. Patent 6,943,646

### Applications

- harmonic rejection
- VHF/UHF transmitters/receivers
- RF suppression for DC lines on PCB
- anti-aliasing for A/D converter

### Electrical Specifications<sup>(1,2)</sup> at 25°C

Parameter	F#	Frequency (MHz)	Min.	Typ.	Max.	Unit	
Pass Band	Insertion Loss	DC-F1	DC-400	—	—	1.0	dB
	Freq. Cut-Off	F2	560	—	3.0	—	dB
	VSWR	DC-F1	DC-400	—	1.2	—	:1
Stop Band	Rejection Loss	F3	660	20	—	—	dB
		F4-F5	680-3000	—	40	—	dB
		F6	5500	—	20	—	dB
VSWR	F3-F6	660-5500	—	20	—	:1	

(1) In Application where DC voltage is present at either input or output ports, coupling capacitors are required. Alternatively, if DC pass IN-OUT is required, Mini-Circuits "D" suffix version of this model will support DC IN-OUT, and provide >100 MOhm isolation to ground.

(2) Measured on Mini-Circuits Characterization Test Board TB-270.

### Typical Frequency Response

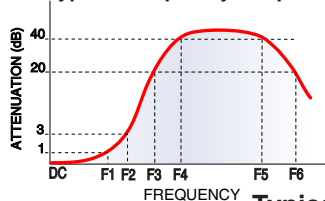

### Electrical Schematic

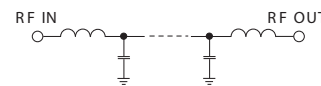

### Typical Performance Data at 25°C

Frequency (MHz)	Insertion Loss (dB)	VSWR (:1)
1.00	0.06	1.02
100.00	0.25	1.10
400.00	0.76	1.11
560.00	2.71	1.97
680.00	35.71	14.74
700.00	45.62	17.22
800.00	42.97	25.19
1000.00	42.26	40.41
1550.00	55.94	75.53
1770.00	71.17	66.82
2500.00	51.63	72.39
3000.00	50.38	57.91
3500.00	43.35	56.04
4340.00	18.96	14.62
5500.00	26.38	28.03

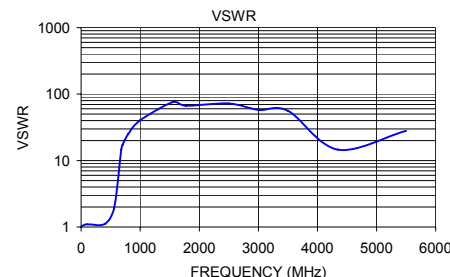

### Notes

- A. Performance and quality attributes and conditions not expressly stated in this specification document are intended to be excluded and do not form a part of this specification document.
- B. Electrical specifications and performance data contained in this specification document are based on Mini-Circuit's applicable established test performance criteria and measurement instructions.
- C. The parts covered by this specification document are subject to Mini-Circuits standard limited warranty and terms and conditions (collectively, "Standard Terms"); Purchasers of this part are entitled to the rights and benefits contained therein. For a full statement of the Standard Terms and the exclusive rights and remedies thereunder, please visit Mini-Circuits' website at [www.minicircuits.com/MCLStore/terms.jsp](http://www.minicircuits.com/MCLStore/terms.jsp)



# Ceramic Low Pass Filter

# LFCN-400+

## Typical Performance Data

FREQ. (MHz)	INSERTION LOSS (dB)			INPUT RETURN LOSS (dB)			OUTPUT RETURNLOSS (dB)		
	@ -55° C	@ +25° C	@ +100° C	@ -55° C	@ +25° C	@ +100° C	@ -55° C	@ +25° C	@ +100° C
1	0.03	0.06	0.09	42.07	40.09	39.54	41.12	40.09	38.43
50	0.15	0.18	0.21	30.23	28.36	27.22	29.64	28.06	26.89
100	0.22	0.25	0.28	26.76	26.50	26.24	25.57	25.38	25.07
400	0.63	0.76	0.88	26.79	25.72	25.08	24.46	23.45	22.71
450	0.81	0.99	1.15	22.85	21.78	20.61	21.95	20.90	19.86
560	2.24	2.71	3.16	9.98	9.71	9.22	12.77	13.36	13.84
565	2.40	2.89	3.38	9.49	9.21	8.75	12.66	13.42	14.03
590	3.71	4.57	5.42	6.83	6.47	6.01	11.97	12.76	13.17
615	7.15	8.72	10.25	3.70	3.45	3.24	7.74	7.58	7.26
635	12.68	14.72	16.71	2.05	2.08	2.06	4.41	4.51	4.47
645	16.32	18.50	20.64	1.63	1.73	1.77	3.48	3.65	3.67
655	20.33	22.72	24.98	1.35	1.48	1.56	2.86	3.08	3.18
660	22.51	25.00	27.35	1.25	1.38	1.48	2.62	2.85	2.94
670	27.36	30.03	32.55	1.12	1.26	1.35	2.27	2.51	2.66
680	32.85	35.71	38.23	1.04	1.18	1.27	2.00	2.26	2.39
700	45.31	45.62	45.32	0.87	1.01	1.12	1.63	1.90	2.04
750	49.40	50.72	51.62	0.69	0.81	0.90	1.22	1.42	1.58
800	43.70	42.97	42.23	0.58	0.69	0.78	1.01	1.20	1.34
880	38.80	38.97	39.05	0.45	0.57	0.65	0.78	0.96	1.06
1000	41.73	42.26	42.69	0.35	0.43	0.52	0.54	0.69	0.78
1100	48.36	49.34	50.10	0.29	0.39	0.46	0.46	0.60	0.67
1150	54.06	55.25	56.46	0.24	0.34	0.42	0.38	0.51	0.58
1210	66.14	67.51	67.11	0.21	0.32	0.39	0.38	0.49	0.57
1550	55.72	55.94	56.95	0.13	0.23	0.32	0.19	0.29	0.31
1770	70.58	71.17	72.04	0.15	0.26	0.34	0.24	0.33	0.37
2000	56.84	56.67	55.81	0.18	0.27	0.35	0.20	0.29	0.33
2500	50.60	51.63	51.81	0.15	0.24	0.29	0.16	0.26	0.28
3000	49.89	50.38	50.55	0.20	0.30	0.34	0.15	0.23	0.27
3500	43.34	43.35	43.45	0.18	0.31	0.39	0.13	0.24	0.29
4000	36.33	37.72	36.35	0.26	0.37	0.50	0.13	0.27	0.39
4340	19.14	18.96	20.49	1.14	1.19	1.00	1.04	1.17	0.93
5000	25.66	26.49	26.63	0.40	0.53	0.64	0.24	0.38	0.51
5500	27.40	26.38	26.03	0.42	0.62	0.80	0.21	0.42	0.55
6000	24.50	25.14	24.76	0.45	0.67	0.90	0.31	0.49	0.64
7000	20.92	20.96	21.33	0.90	1.26	1.55	0.42	0.55	0.61
8000	18.68	18.98	19.33	0.73	0.88	0.94	0.34	0.50	0.59
9000	17.55	17.31	17.29	0.88	1.12	1.37	0.33	0.58	0.73
10000	15.98	16.15	16.03	0.91	1.23	1.57	0.62	1.01	1.36
11000	18.07	19.61	21.53	2.16	2.95	3.45	2.84	3.66	4.35
13000	25.79	23.96	22.37	2.03	2.72	3.35	1.89	2.28	2.45
15000	8.66	8.76	8.53	4.82	5.27	5.88	4.64	4.81	5.08

REV. X1  
LFCN-400+  
070925  
Page 1 of 1



IF/RF MICROWAVE COMPONENTS • ISO 9001 ISO 14001 AS 9100 CERTIFIED • RoHS compliant  
P.O. Box 350166, Brooklyn, New York 11235-0003 (718) 934-4500 Fax (718) 332-4661



The Design Engineers Search Engine finds the model you need, Instantly • For detailed performance specs & shopping online see



# Ceramic Low Pass Filter

## Typical Performance Curves

# LFCN-400+

### INSERTION LOSS vs. TEMPERATURE

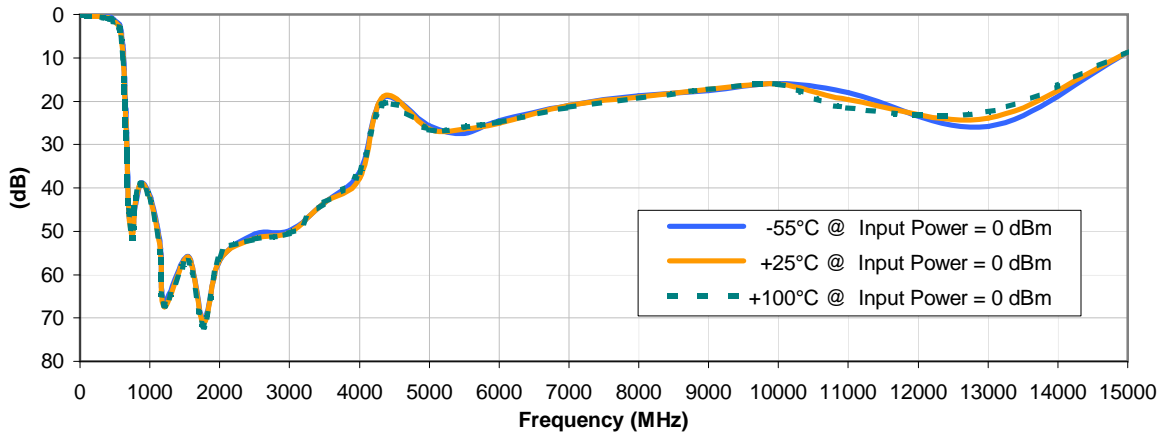

### INPUT RETURN LOSS vs. TEMPERATURE

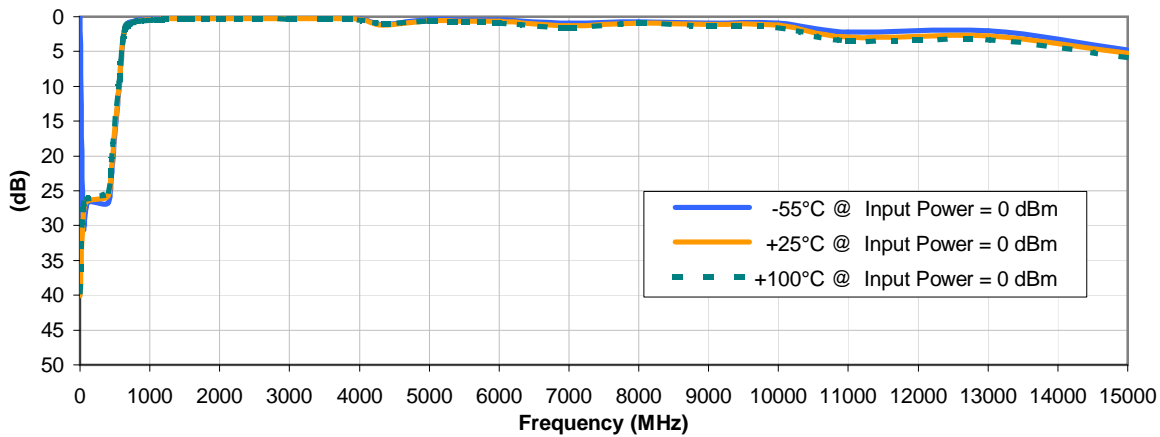

### OUTPUT RETURN LOSS vs. TEMPERATURE

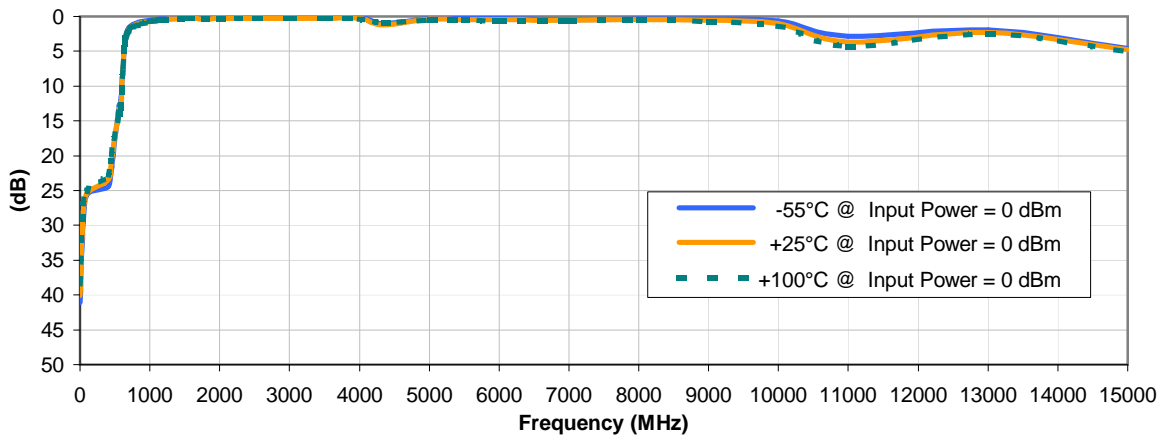

REV. X1  
LFCN-400+  
070925  
Page 1 of 1



IF/RF MICROWAVE COMPONENTS • ISO 9001 ISO 14001 AS 9100 CERTIFIED • RoHS compliant  
P.O. Box 350166, Brooklyn, New York 11235-0003 (718) 934-4500 Fax (718) 332-4661



The Design Engineers Search Engine finds the model you need, Instantly • For detailed performance specs & shopping online see



### Outline Dimensions

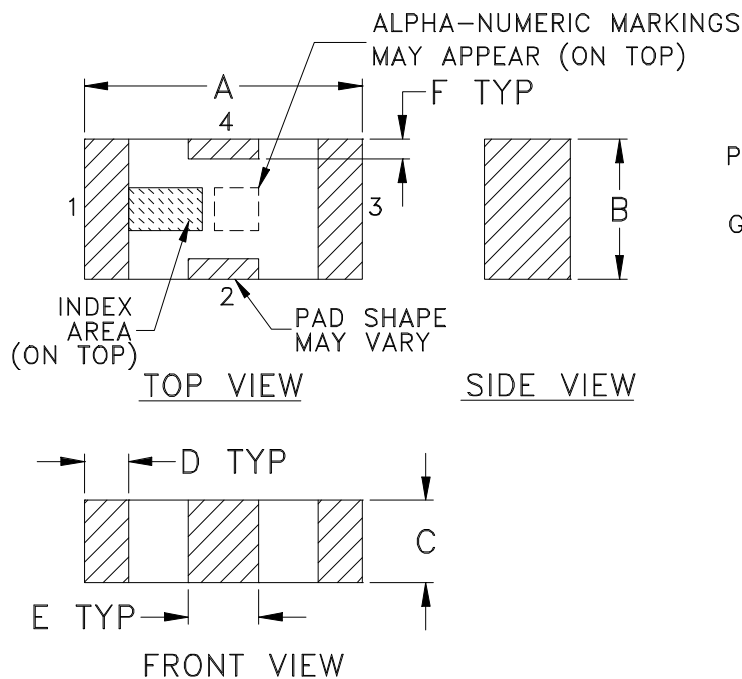

### PCB Land Pattern

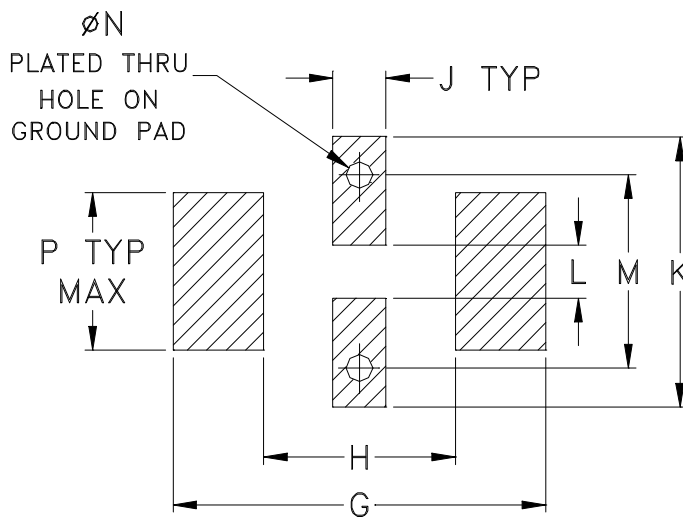

Suggested Layout,  
Tolerance to be within  $\pm .002$

CASE #	A	B	C	D	E	F	G	H	J	K	L	M	N	P	WT. GRAM
FV1206	.126 (3.20)	.063 (1.60)	.037 (0.94)	.020 (0.51)	.032 (0.81)	.009 (0.23)	.169 (4.29)	.087 (2.21)	.024 (0.61)	.122 (3.10)	.024 (0.61)	.087 (2.21)	.012 (0.30)	.071 (1.80)	.020

Dimensions are in inches (mm). Tolerances: 2 Pl.  $\pm .01$ ; 3 Pl.  $\pm .005$

#### Notes:

- Open style, ceramic base.
- Termination finish:  
 For RoHS Case Styles: Tin plate over Nickel plate. All models, (+) suffix.  
 For RoHS-5 Case Styles: Tin-Lead plate. All models, no (+) suffix.

# Tape & Reel Packaging TR-F71

## DEVICE ORIENTATION IN T&R

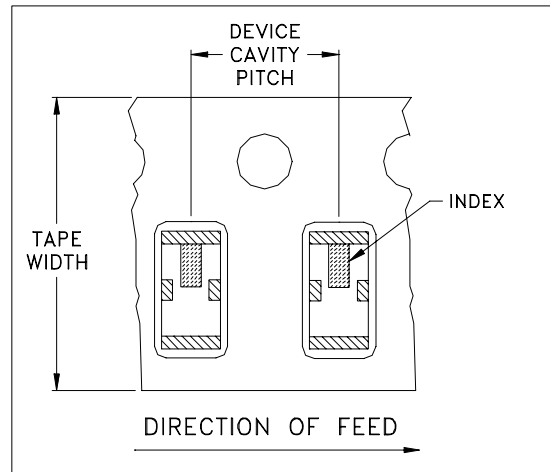

ILLUSTRATION 1

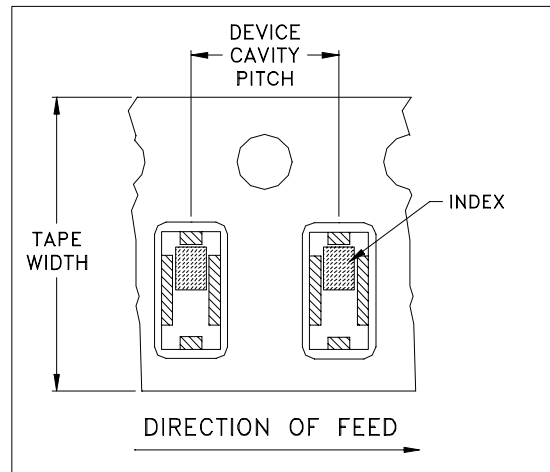

ILLUSTRATION 2

Tape Width, mm	Device Cavity Pitch, mm	Reel Size, inches	Devices per Reel	
8	4	7	Small quantity standards (see note)	20
				50
				100
				200
				500
			Standard	3000

Note: Please consult individual model data sheet to determine device per reel availability.

Mini-Circuits carrier tape materials provide protection from ESD (Electro-Static Discharge) during handling and transportation. Tapes are static dissipative and comply with industry standards EIA-481/EIA-541.

Go to: [www.minicircuits.com/pages/pdfs/tape.pdf](http://www.minicircuits.com/pages/pdfs/tape.pdf)



INTERNET <http://www.minicircuits.com>

P.O. Box 350166, Brooklyn, New York 11235-0003 (718) 934-4500 Fax (718) 332-4661

Distribution Centers NORTH AMERICA 800-654-7949 • 417-335-5935 • Fax 417-335-5945 • EUROPE 44-1252-832600 • Fax 44-1252-837010

Mini-Circuits ISO 9001 & ISO 14001 Certified

THIRD ANGLE PROJECTION

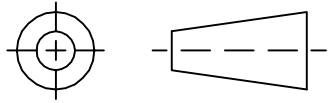

REVISIONS

REV	ECN No.	DESCRIPTION	DATE	DR	AUTH
OR	M88634	NEW RELEASE	08/28/03	GF	ABD
A	M102713	ADDED "...WITH SMOBC"	01/17/06	MMG	IL

SUGGESTED MOUNTING CONFIGURATION  
FOR FV1206 CASE STYLE, "nx" PIN CONNECTION

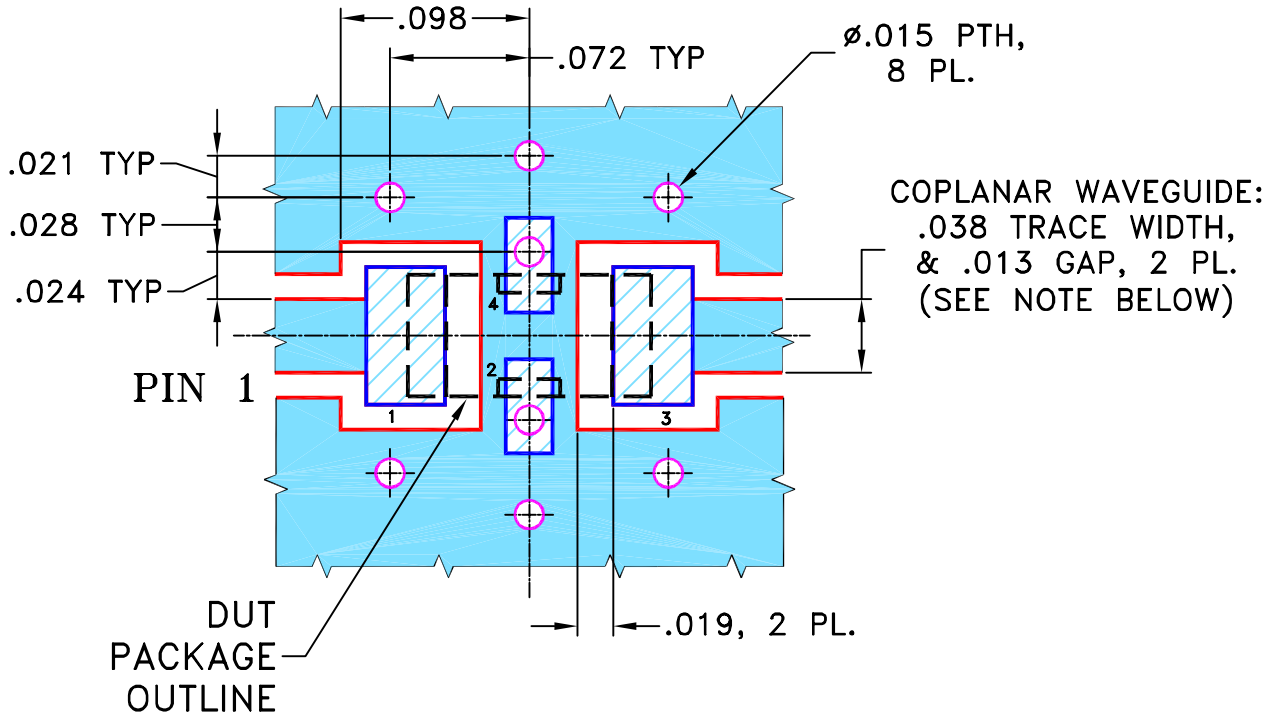

- NOTES:**
1. COPLANAR WAVEGUIDE PARAMETERS ARE SHOWN FOR ROGERS R04350B WITH THICKNESS .020" ± .0015".  
 COPPER: 1/2 OZ. EACH SIDE.  
 FOR OTHER MATERIALS TRACE WIDTH & GAP MAY NEED TO BE MODIFIED.

2. BOTTOM SIDE OF THE PCB IS CONTINUOUS GROUND PLANE.



DENOTES PCB COPPER LAYOUT WITH SMOBC  
 (SOLDER MASK OVER BARE COPPER)



DENOTES COPPER LAND PATTERN FREE OF SOLDER MASK

UNLESS OTHERWISE SPECIFIED

INITIALS

DATE

DIMENSIONS ARE IN INCHES

DRAWN

GF

08/27/03

TOLERANCES ON:

CHECKED

AV

08/28/03

2 PL DECIMALS ±

APPROVED

ABD

08/28/03

3 PL DECIMALS ± .005

ANGLES ±

FRACTIONS ±

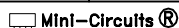

Mini-Circuits®

13 Neptune Avenue  
 Brooklyn NY 11235

PL, nx, FV1206, LFCN/HFCN, TB-270

THIS DOCUMENT AND ITS CONTENTS ARE THE PROPERTY OF MINI-CIRCUITS. EXCEPT FOR USE EXPRESSLY GRANTED, IN WRITING, TO ITS VENDORS, VENDEE AND THE UNITED STATES GOVERNMENT, MINI-CIRCUITS RESERVES ALL PROPRIETARY DESIGN, USE, MANUFACTURING AND REPRODUCTION RIGHTS THERETO. THESE CONTENTS SHALL NOT BE USED, DUPLICATED OR DISCLOSED TO ANY OUTSIDE PARTY, IN WHOLE OR IN PART, WITHOUT WRITTEN PERMISSION OF MINI-CIRCUITS.

SIZE

CODE IDENT

DRAWING NO:

REV:

A

15542

98-PL-137

A

FILE: 98PL137

SCALE:

10:1

SHEET:

1 OF 1

ASHEETA1.DWG REV:A DATE:01/12/95

# Evaluation Board and Circuit

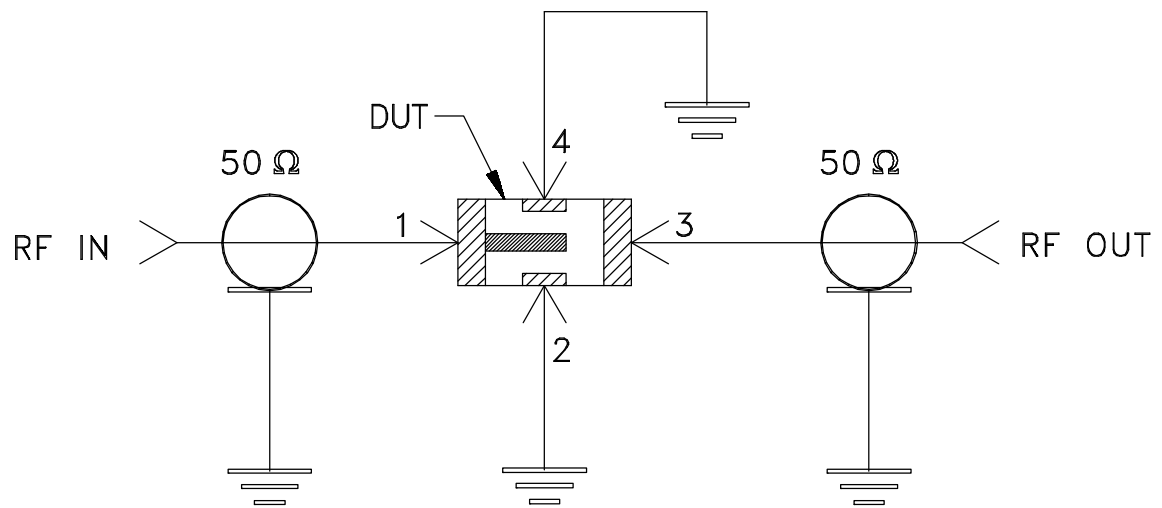
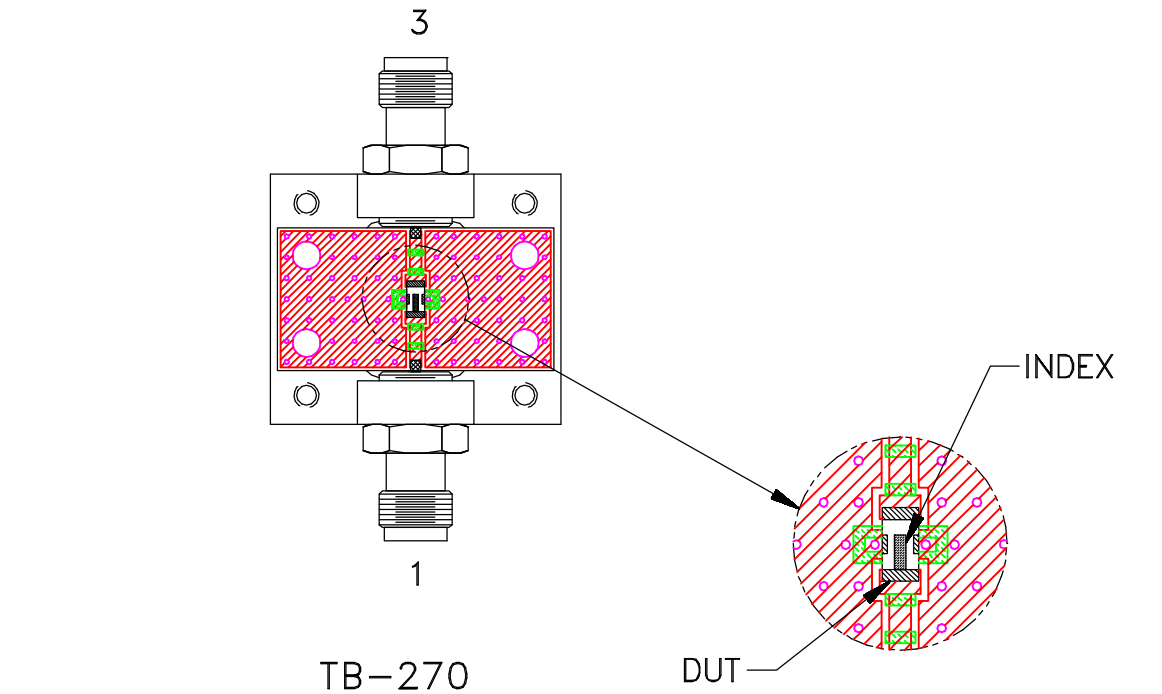

Schematic Diagram

## Notes:

1. SMA Female connectors.
2. PCB Material: ROGERS R04350 or equivalent,  
Dielectric Constant=3.5, Thickness=.020 inch.

 **Mini-Circuits®**

All Mini-Circuits products are manufactured under exacting quality assurance and control standards, and are capable of meeting published specifications after being subjected to any or all of the following physical and environmental test.

Specification	Test/Inspection Condition	Reference/Spec
Operating Temperature	-55° to 100°C Ambient Environment	Individual Model Data Sheet
Storage Temperature	-55° to 100° C Ambient Environment	Individual Model Data Sheet
Humidity	90 to 95% RH, 240 hours, 50°C	MIL-STD-202, Method 103, Condition A, Except 50°C and end-point electrical test done within 12 hours
Solder Reflow Heat	Sn-Pb Eutetic Process: 225°C peak Pb-Free Process 245° - 250°C peak	J-STD-020, Table 4-1, 4-2 and 5-2, Figure 5-1
Solderability	10X Magnification	J-STD-002, Para 4.2.5, Test S, 95% Coverage
Vibration (High Frequency)	20g peak, 10-2000 Hz, 12 times in each of three perpendicular directions (total 36)	MIL-STD-202, Method 204, Condition D
Mechanical Shock	50g, 11 ms, 1/2-sine, 18 shocks: 3 each direction, each of 3 axes	MIL-STD-202, Method 213, Condition A