

SPECIFICATIONS FOR STANDARD LED LAMPS

L 800 Series

WENRUN OPTOELECTRONIC

Features:

- High speed response.
- High reliability and long life.
- Low power consumption.
- Available in red, blue, white ,green, yellow colors.
- Suitable for pulse operation.

**Descriptions:**

- The LED lamps are available with different colors, intensities, epoxy colors, etc.
- Superior performance in outdoor environment.

Applications:

- These lamp are widely used for various application.
- Indication of all kinds.
- Commercial use.

Selection Guide:

Part No.	Chip		Lens Type
	Material	Emitting Color	
LG80030	GaP	Green	Green Diffused
LY80030	GaAsP/GaP	Yellow	Yellow Diffused
LSR80030	GaAlAs	Super Red	Red Diffused
LI80030	GaAsP	Orange	Red Diffused

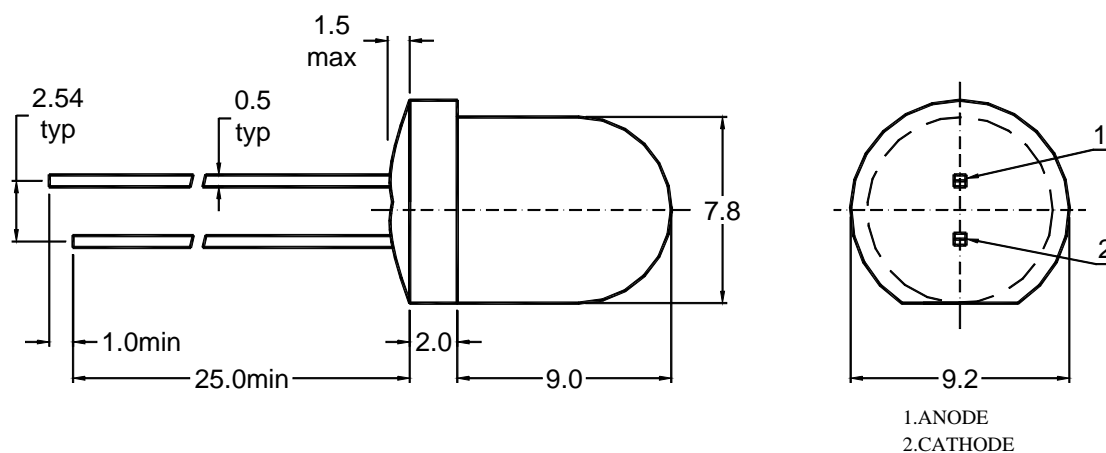
Package Dimensions:**NOTES :**

- 1、 All dimensions are in millimetres (mm).
- 2、 Tolerance is $\pm 0.25\text{mm}(0.01\text{'})$ unless otherwise noted.
- 3、 Protruded resin under flange is 1.5mm Max LED.

Absolute Maximum Rating ($T_a=25$)

Parameter	Symbol	Green	Yellow	Super Red	Orange	Unit
Power Dissipation	P_d	60	60	50	60	mW
Pulse Forward Current (Duty 1/10 @ 1kHz)	I_{FP}	70	70	70	70	mA
Continuous Forward Current	I_F	20	20	20	20	mA
Reverse Voltage	V_R	5	5	5	5	V
Operating Temperature Range	T_{opr}	-30 ~ +85				
Storage Temperature Range	T_{stg}	-40 ~ +100				
Soldering Temperature	T_{sol}	260 \pm 5				

Notes : Soldering time 5 seconds.

Electrical Optical Characteristics (Ta=25)

Parameter	Symbol	Green		Yellow		Super Red		Orange		Unit	Test Condition
		Typ.	Max.	Typ.	Max.	Typ.	Max.	Typ.	Max.		
Luminous Intensity	I _v	60	--	40	--	80	--	50	--	mcd	I _F =20mA
Forward Voltage	V _F	2.2	2.5	2.0	2.5	1.85	2.3	2.0	2.5	V	I _F =20mA
Reverse Current	I _R	--	50	--	50	--	50	--	50	uA	V _R =5V
Dominant Wavelength	d	565	--	585	--	645	--	630	--	nm	I _F =20mA
Peak Emission Wavelength	p	562	--	588	--	655	--	636	--	nm	I _F =20mA
Spectral Line Half Width		30	--	30	--	30	--	30	--	nm	I _F =20mA
Viewing Angle	2 1/2	45	--	45	--	45	--	45	--	deg	I _F =20mA

Reliability Test Items and Conditions

NO	Test Item	Test Conditions	Duration	Sample	Ac/Re
1	Temperature Cycle	-40 ~ 25 ~ 100 ~ 25 30min 5min 30min 5min	50cycles	100	0/1
2	High Temp. Storage	Ta=100	1000hours	100	0/1
3	Temp.& Humidity Test	Ta=85 RH=85%	1000hours	100	0/1
4	Low Temp. Storage	Ta=-40	1000hours	100	0/1
5	Operating Life Test	Ta=25 ± 5 DC IF=20mA	1000hours	100	0/1
6	Solder Heat	Tsol=260 ± 5 , 10s	1times	20	0/1

Typical Electro-Optical Characteristics Curves :

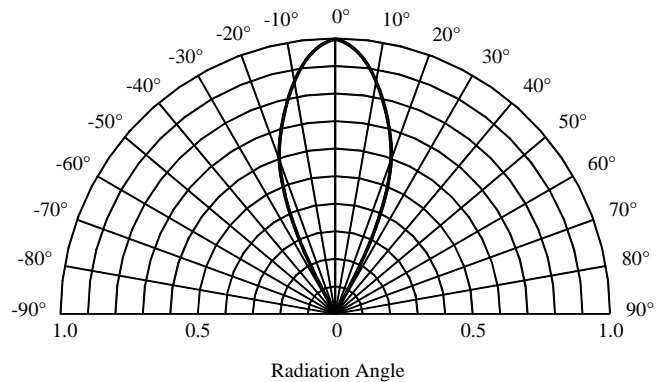
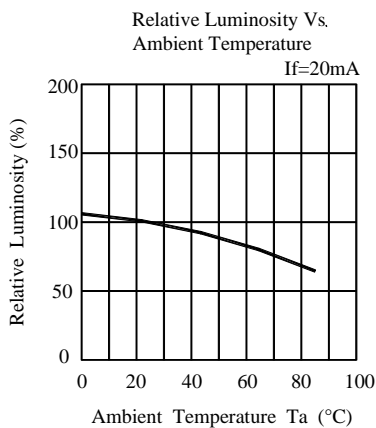
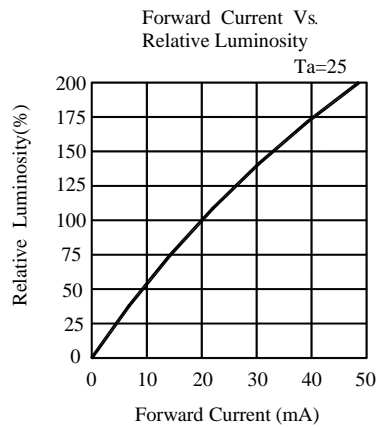
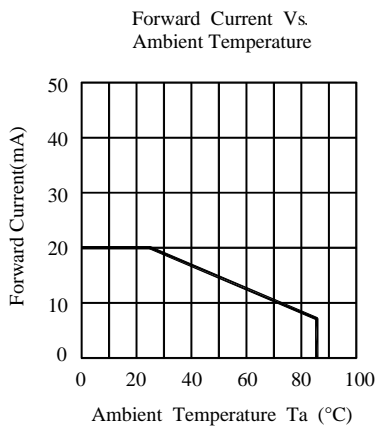
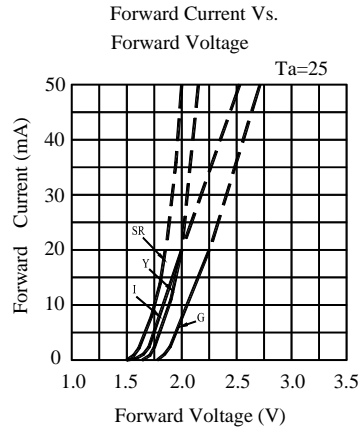
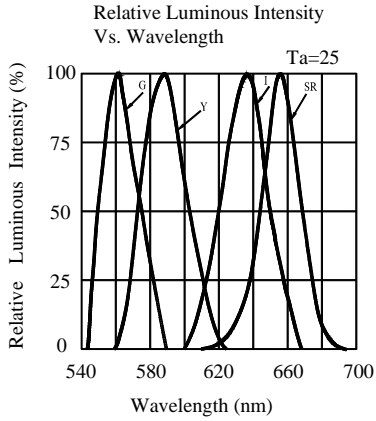

Label Form Specification

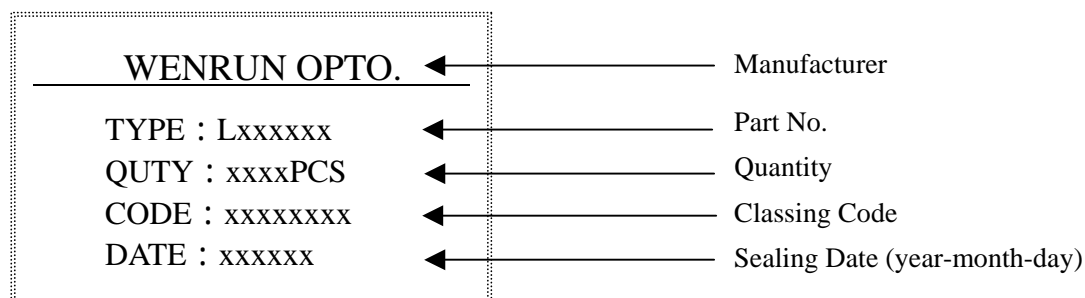

Precautions In Use

A、Soldering Conditions

- 1、 When soldering, leave the minimum clearance between the bottom of the resin and the soldering point.
- 2、 Maximum allowable soldering conditions are.
 - Solder dipping: 260 max., 5 seconds max., one time.
 - Soldering iron: 350 max., 5 seconds max., one time.
- 3、 Contact between molten solder and the resin must be avoided.
- 4、 In soldering, do not put any stress on the lead frame, particularly when heated.

B、Lead frame Forming and Use

- 1、 When forming leads ,the leads should be bent at a point at least 3mm from the base of epoxy. Lead forming should be done before soldering.
- 2、 Do not apply any bending stress to the base of the lead. The stress to the base may damage the LEDs characteristics.
- 3、 When mounting the LEDs onto a printed circuit board ,the holes on the circuit board should be exactly aligned with the leads of the LEDs.
- 4、 Please avoid conditions which may cause the LED to corrode, tarnish or discolor. This corrosion or discoloration may cause difficulty during soldering operations. It is recommended that the LEDs be used as soon as possible.
- 5、 Please avoid rapid transitions in ambient temperature, especially, in high humidity environments.

Notes:

- 1、 Above specification may be changed without notice. We will reserve authority on material change for above specification.
- 2、 When using this product, please observe the absolute maximum ratings and the instructions for the specification sheets. We assume no responsibility for any damage resulting from use of the product which does not comply with the instructions included in the specification sheets.