

SERVICE MANUAL MODEL: LGDVT418

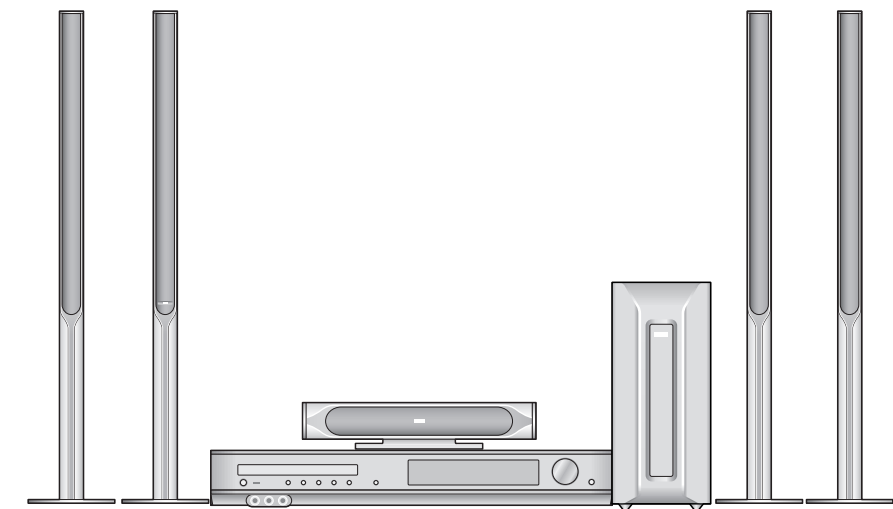

DVD/CD RECEIVER SERVICE MANUAL



MODEL: LGDVT418

P/N : 3829RDT044U

AUGUST, 2004

[CONTENTS]

○ SECTION 1. GENERAL

- SERVICING PRECAUTIONS 1-2
- ESD PRECAUTIONS 1-4
- SPECIFICATIONS 1-5

○ SECTION 2. AUDIO PART

- ELECTRICAL TROUBLESHOOTING GUIDE 2-1
- BLOCK DIAGRAM 2-5
- SCHEMATIC DIAGRAMS 2-7
- WIRING DIAGRAMS 2-21
- PRINTED CIRCUIT DIAGRAMS 2-23

○ SECTION 3. DVD PART

- DVD PART ELECTRICAL TROUBLESHOOTING GUIDE 3-1
- DETAILS AND WAVEFORMS ON SYSTEM TEST AND DEBUGGING 3-8
- BLOCK DIAGRAM 3-21
- DVD PART SCHEMATIC DIAGRAMS 3-25

○ SECTION 4. EXPLODED VIEWS 4-1

○ SECTION 5. SPEAKER PART 5-1

○ SECTION 6. REPLACEMENT PARTS LIST 6-1

SECTION 1. GENERAL

□ SERVICING PRECAUTIONS

NOTES REGARDING HANDLING OF THE PICK-UP

1. Notes for transport and storage

- 1) The pick-up should always be left in its conductive bag until immediately prior to use.
- 2) The pick-up should never be subjected to external pressure or impact.

Storage in conductive bag

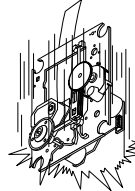
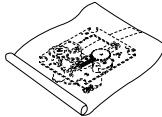

Drop impact

2. Repair notes

- 1) The pick-up incorporates a strong magnet, and so should never be brought close to magnetic materials.
- 2) The pick-up should always be handled correctly and carefully, taking care to avoid external pressure and impact. If it is subjected to strong pressure or impact, the result may be an operational malfunction and/or damage to the printed-circuit board.
- 3) Each and every pick-up is already individually adjusted to a high degree of precision, and for that reason the adjustment point and installation screws should absolutely never be touched.
- 4) Laser beams may damage the eyes!
Absolutely never permit laser beams to enter the eyes!
Also NEVER switch ON the power to the laser output part (lens, etc.) of the pick-up if it is damaged.

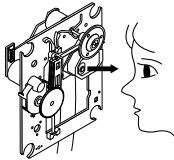

NEVER look directly at the laser beam, and don't let contact fingers or other exposed skin.

5) Cleaning the lens surface

If there is dust on the lens surface, the dust should be cleaned away by using an air bush (such as used for camera lens). The lens is held by a delicate spring. When cleaning the lens surface, therefore, a cotton swab should be used, taking care not to distort this.

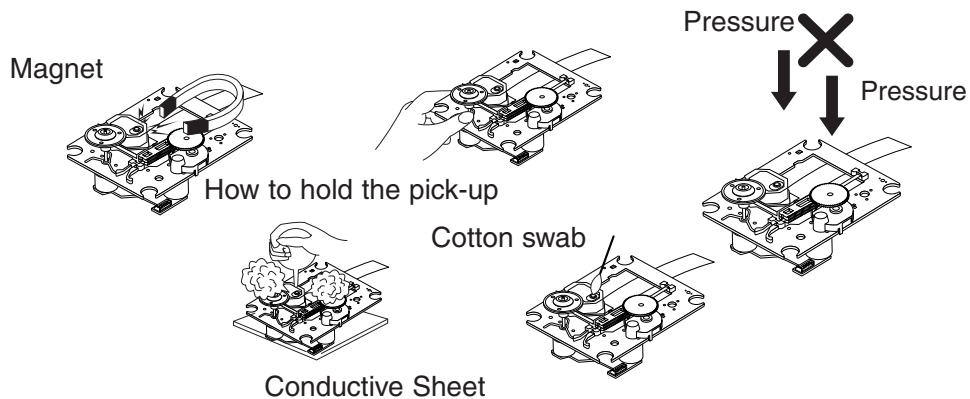

6) Never attempt to disassemble the pick-up.

Spring by excess pressure. If the lens is extremely dirty, apply isopropyl alcohol to the cotton swab. (Do not use any other liquid cleaners, because they will damage the lens.) Take care not to use too much of this alcohol on the swab, and do not allow the alcohol to get inside the pick-up.

NOTES REGARDING COMPACT DISC PLAYER REPAIRS

1. Preparations

- 1) Compact disc players incorporate a great many ICs as well as the pick-up (laser diode). These components are sensitive to, and easily affected by, static electricity. If such static electricity is high voltage, components can be damaged, and for that reason components should be handled with care.
- 2) The pick-up is composed of many optical components and other high-precision components. Care must be taken, therefore, to avoid repair or storage where the temperature or humidity is high, where strong magnetism is present, or where there is excessive dust.

2. Notes for repair

- 1) Before replacing a component part, first disconnect the power supply lead wire from the unit
- 2) All equipment, measuring instruments and tools must be grounded.
- 3) The workbench should be covered with a conductive sheet and grounded.
When removing the laser pick-up from its conductive bag, do not place the pick-up on the bag. (This is because there is the possibility of damage by static electricity.)
- 4) To prevent AC leakage, the metal part of the soldering iron should be grounded.
- 5) Workers should be grounded by an armband (1M Ω)
- 6) Care should be taken not to permit the laser pick-up to come in contact with clothing, in order to prevent static electricity changes in the clothing to escape from the armband.
- 7) The laser beam from the pick-up should NEVER be directly facing the eyes or bare skin.

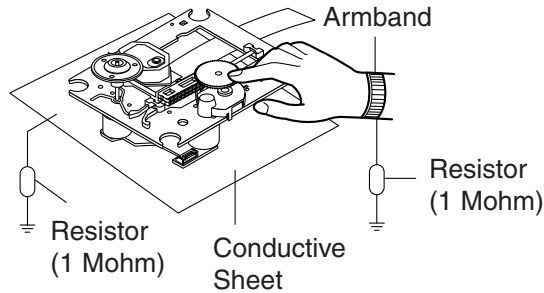

□ ESD PRECAUTIONS

Electrostatically Sensitive Devices (ESD)



Some semiconductor (solid state) devices can be damaged easily by static electricity. Such components commonly are called Electrostatically Sensitive Devices (ESD). Examples of typical ESD devices are integrated circuits and some field-effect transistors and semiconductor chip components. The following techniques should be used to help reduce the incidence of component damage caused by static electricity.

1. Immediately before handling any semiconductor component or semiconductor-equipped assembly, drain off any electrostatic charge on your body by touching a known earth ground. Alternatively, obtain and wear a commercially available discharging wrist strap device, which should be removed for potential shock reasons prior to applying power to the unit under test.
2. After removing an electrical assembly equipped with ESD devices, place the assembly on a conductive surface such as aluminum foil, to prevent electrostatic charge buildup or exposure of the assembly.
3. Use only a grounded-tip soldering iron to solder or unsolder ESD devices.
4. Use only an anti-static solder removal device. Some solder removal devices not classified as "anti-static" can generate electrical charges sufficient to damage ESD devices.
5. Do not use freon-propelled chemicals. These can generate electrical charges sufficient to damage ESD devices.
6. Do not remove a replacement ESD device from its protective package until immediately before you are ready to install it. (Most replacement ESD devices are packaged with leads electrically shorted together by conductive foam, aluminum foil or comparable conductive materials).
7. Immediately before removing the protective material from the leads of a replacement ESD device, touch the protective material to the chassis or circuit assembly into which the device will be installed.

CAUTION : BE SURE NO POWER IS APPLIED TO THE CHASSIS OR CIRCUIT, AND OBSERVE ALL OTHER SAFETY PRECAUTIONS.

8. Minimize bodily motions when handling unpackaged replacement ESD devices. (Otherwise harmless motion such as the brushing together of your clothes fabric or the lifting of your foot from a carpeted floor can generate static electricity sufficient to damage an ESD device).

CAUTION. GRAPHIC SYMBOLS

	THE LIGHTNING FLASH WITH APROWHEAD SYMBOL, WITHIN AN EQUILATERAL TRIANGLE, IS INTENDED TO ALERT THE SERVICE PERSONNEL TO THE PRESENCE OF UNINSULATED "DANGEROUS VOLTAGE" THAT MAY BE OF SUFFICIENT MAGNITUDE TO CONSTITUTE A RISK OF ELECTRIC SHOCK.
	THE EXCLAMATION POINT WITHIN AN EQUILATERAL TRIANGLE IS INTENDED TO ALERT THE SERVICE PERSONNEL TO THE PRESENCE OF IMPORTANT SAFETY INFORMATION IN SERVICE LITERATURE.

□ SPECIFICATIONS

[General]	Power supply	Refer to main label		
	Power consumption	Refer to main label		
	Mass	4.4kg		
	External dimensions (W x H x D)	430 x 60 x 350mm		
	Operating conditions	Temperature: 5°C to 35°C, Operation status: Horizontal		
	Operating humidity	5% to 85%		
[CD/DVD]	Laser	Semiconductor laser, wavelength 650 nm		
	Signal system	PAL 625/50, NTSC 525/60		
	Frequency response (audio)	150 Hz to 18 kHz		
	Signal-to-noise ratio (audio)	More than 75 dB (1 kHz, NOP -6dB, 20 kHz LPF/A-Filter)		
	Dynamic range (audio)	More than 70 dB		
	Harmonic distortion (audio)	1% (1 kHz, at 1W position) (20 kHz LPF)		
[Video]	Video input	1.0 V (p-p), 75Ω, negative sync., RCA jack x 2/SCART(TO TV)		
	Video output	1.0 V (p-p), 75Ω, negative sync., RCA jack x 1/SCART(TO TV)		
	S-video output	(Y) 1.0 V (p-p), 75Ω, negative sync., Mini DIN 4-pin x 1 (C) 0.3 V (p-p), 75Ω		
[Tuner]	[FM]	Tuning Range	87.5 - 108.0 MHz or 65.0 - 74.0 MHz, 87.5 - 108.0MHz	
		Intermediate Frequency	10.7 MHz	
		Signal-to Noise Ratio	60dB (Mono)	
	[AM [MW]]	Frequency Response	150 - 8,000 Hz	
		Tuning Range	522~1,611kHz, 530 ~1,610kHz	
		Intermediate Frequency	450 kHz	
[Amplifier]	Stereo mode	90W + 90W (6Ω at 1 kHz, THD 10 %)		
	Surround mode (* Depending on the sound mode settings and the source, there may be no sound output.)	Front: 90W + 90W (THD 10 %) Centre*: 90W Surround*: 90W + 90W (6Ω at 1 kHz, THD 10 %) Subwoofer*: 150W (4Ω at 30 Hz, THD 10 %)		
	Inputs	VIDEO 1, VIDEO 2, COAXIAL AUDIO, OPTICAL AUDIO		
	Outputs	S-VIDEO, MONITOR, PHONES: 32Ω, (1.0 V), COMPONENT (구주향 SCART포함)		
[Speakers]		Surround Speaker (LHS-T6749T)	Centre speaker (LHS-T6749C)	Passive Subwoofer (LHS-T6749W)
	Type	2 Way 2 Speaker	2 Way 2 Speaker	1Way 1Speaker
	Impedance	6Ω	6Ω	4Ω
	Frequency Response	150-20,000 Hz	150 -20,000 Hz	40 - 200 Hz
	Sound Pressure Level	84 dB/W (1m)	84 dB/W (1m)	83 dB/W (1m)
	Rated Input Power	90W	90 W	150 W
	Max. Input Power	180 W	180W	300 W
	Net Dimensions (W x H x D)	70x1200x 72mm	440x 88 x 77mm	195 x 398 x 417 mm
Net Weight	3.2kg	1.8kg	7.6kg	
[Supplied Accessories]	<ul style="list-style-type: none"> • Speakers6 • AM loop antenna1 • Remote control1 • Speaker cables6 • FM antenna1 • Batteries (AAA)2 			

Designs and specifications are subject to change without notice.

MEMO

SECTION 2. AUDIO PART

ELECTRICAL TROUBLESHOOTING GUIDE

1. Power check flow

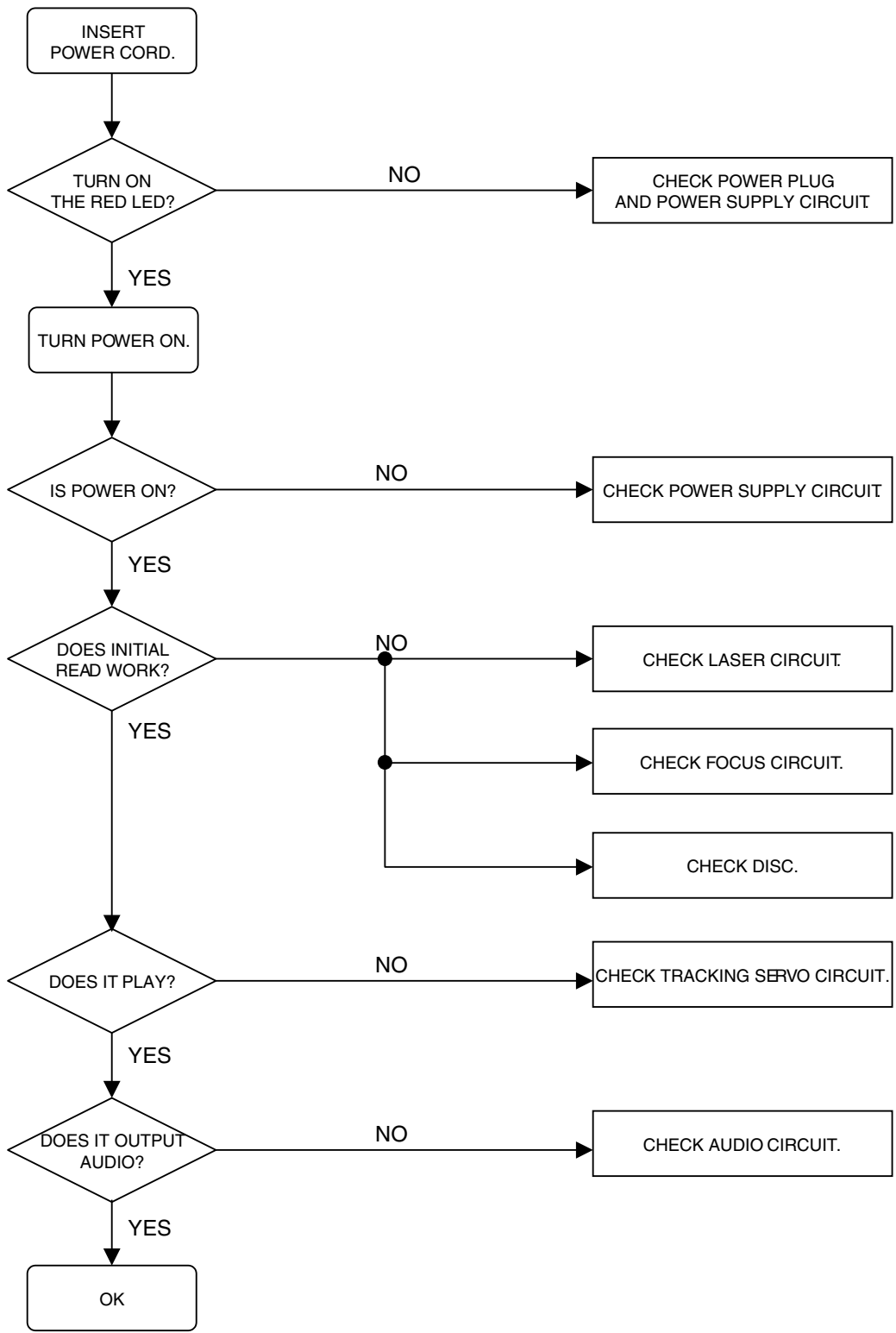

2.AUDIO μ .COM CIRCUIT

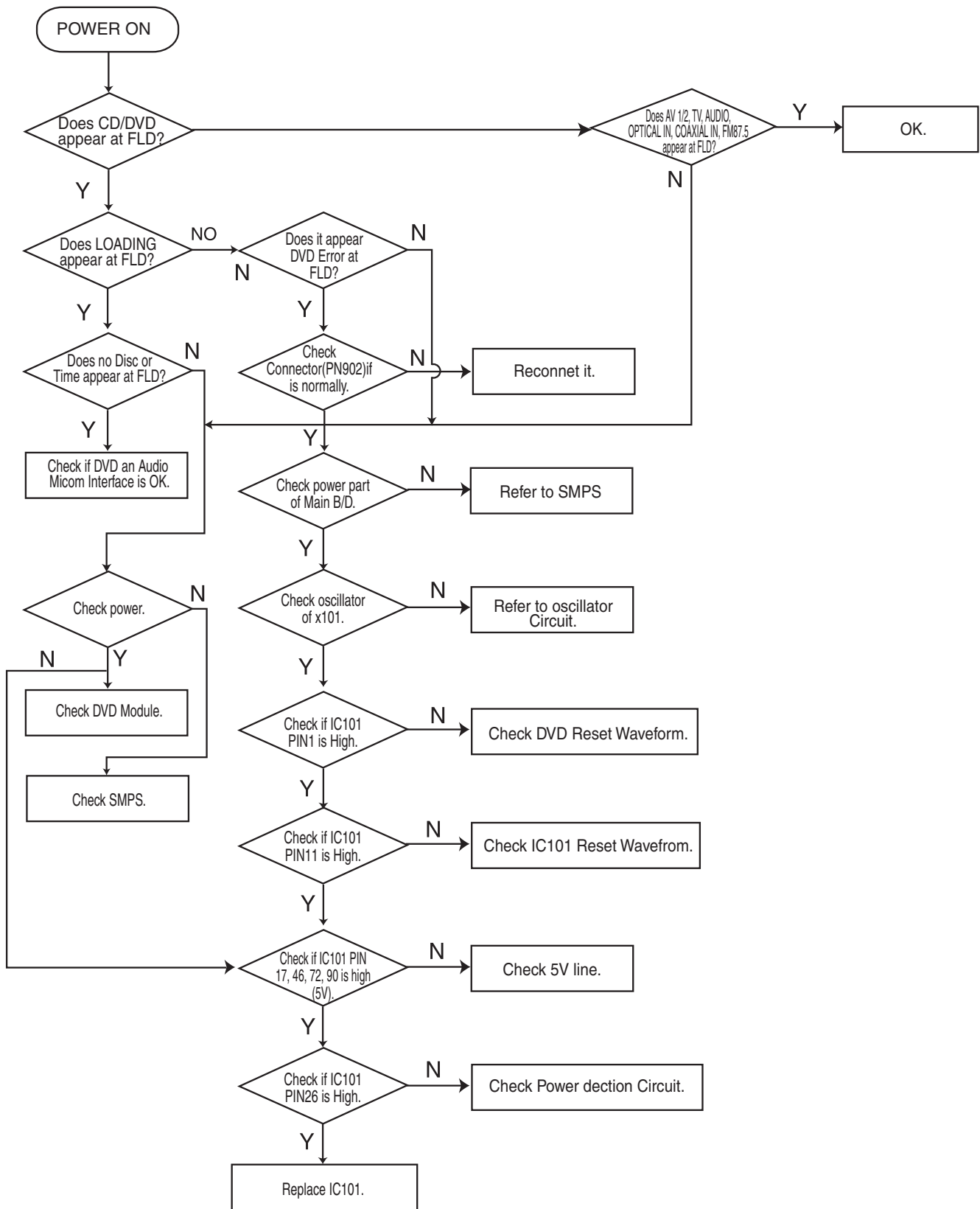

3.FRONT CIRCUIT (1/2)

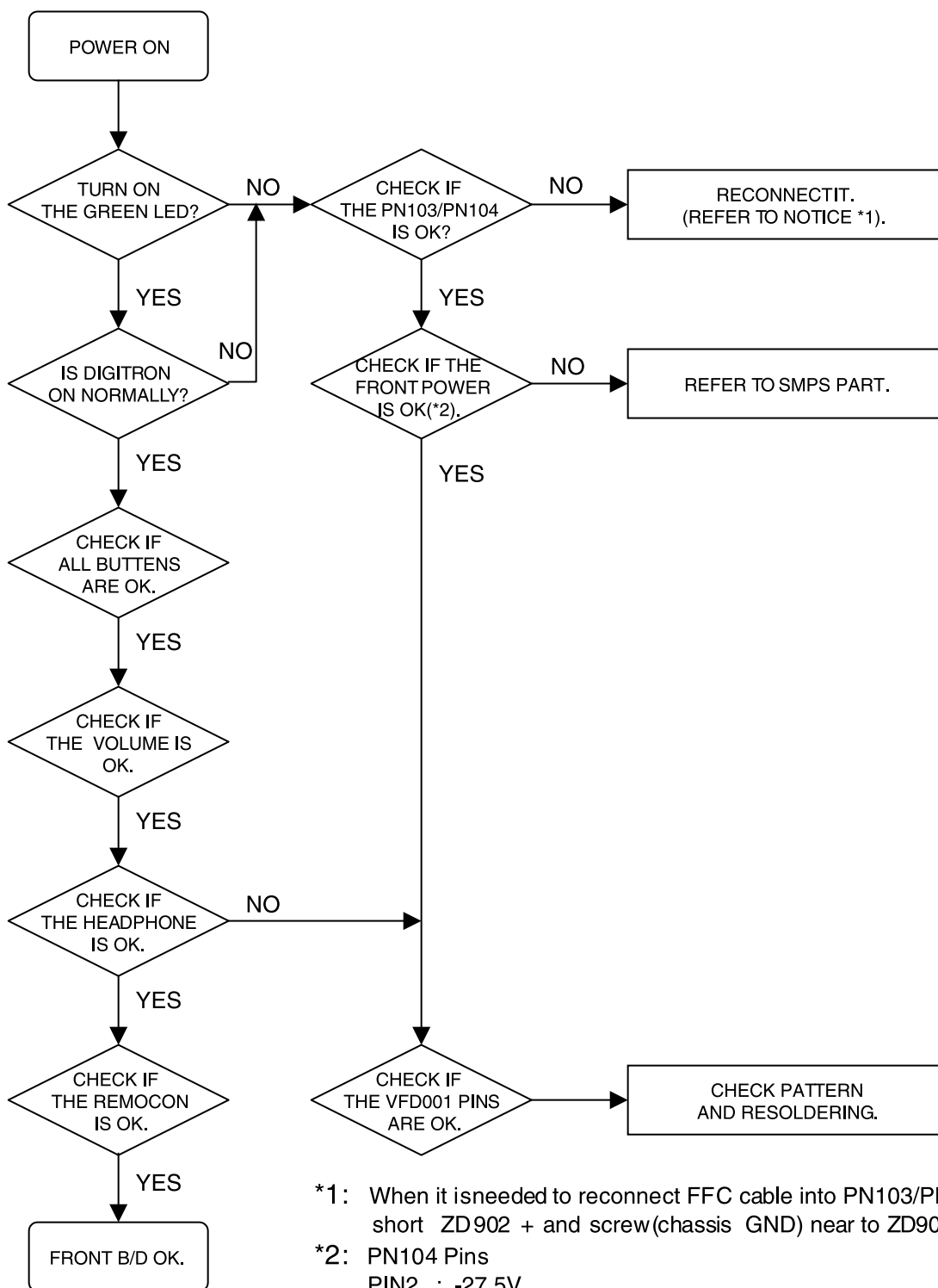

*1: When it is needed to reconnect FFC cable into PN103/PN104, short ZD902 + and screw(chassis GND) near to ZD902.

*2: PN104 Pins
 PIN2 : -27.5V
 PIN3 : -23.0V
 PIN4 : 5.0V
 PIN11 : -34.0V

4.FRONT CIRCUIT (2/2)

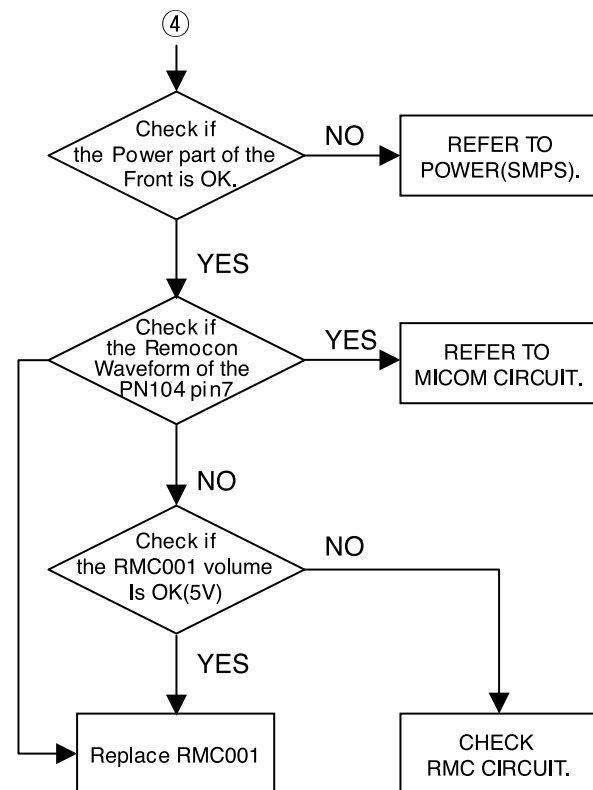
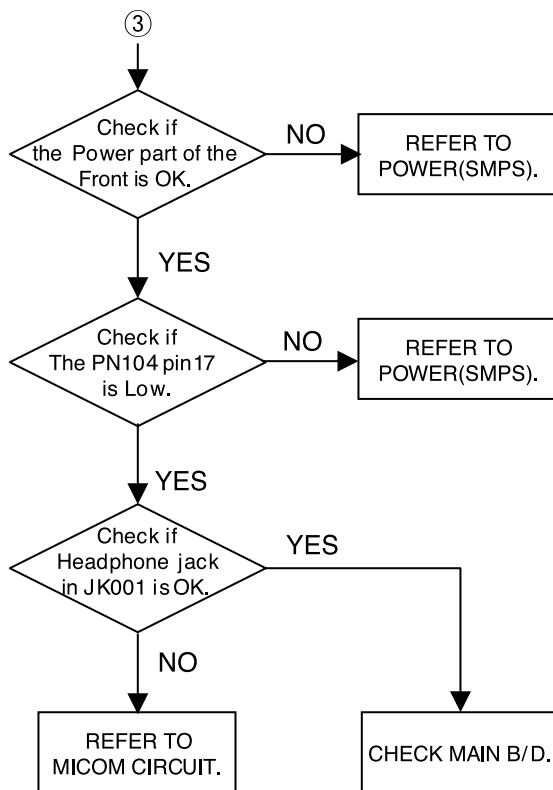
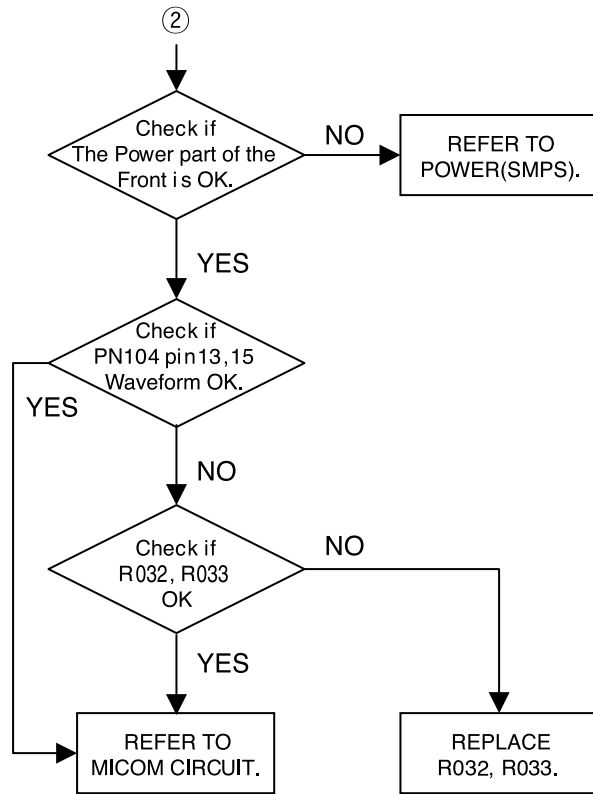
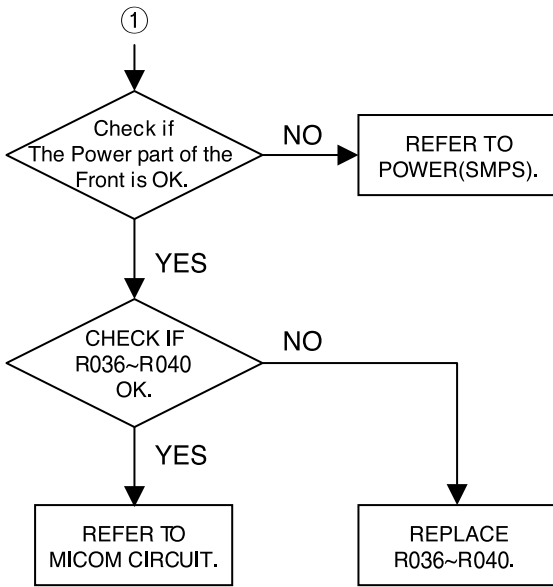

□ BLOCK DIAGRAM

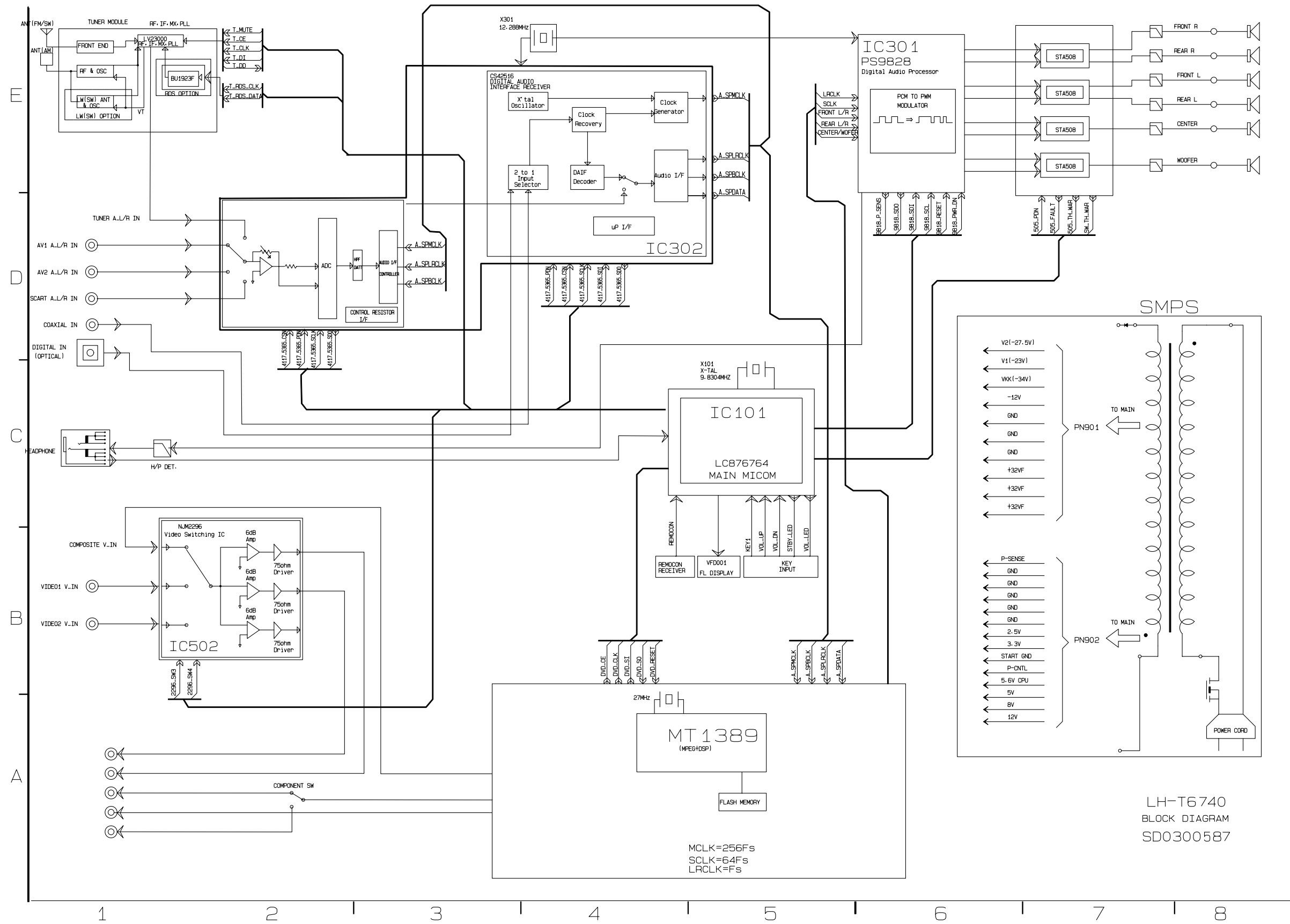

LH-T6740
BLOCK DIAGRAM
SD0300587

SCHEMATIC DIAGRAMS

FRONT SCHEMATIC DIAGRAM

F
E
D
C
B
A

FRONT PCB MAIN

1) DIODE OPTION

Symbol No.	CONTENTS	TABLE
D001	AREA-1	1 1 0
D002	AREA-2	1 1 0
D003	AREA-3	REMARK
D004	FM 4140	100K 50K
D005	AM 4140	10K 5K
D006	RDS	RDS NON RDS
D007	SCART COMPONENT	SCART COMPONENT
D008	XTS	NON USE USE
D009	OUTPUT POWER 1	60/120W 45/100W
D010	OUTPUT POWER 2	90/150W -

2) AREA OPTION

Area	D001	D002	D003
KOR	0	0	0
USA	1	0	0
EUROPE1	0	1	0
SAC	1	1	0
EUROPE2	0	0	1
AFRICA	1	0	1
ASIAN	0	1	1
EUROPE3	1	1	1

3) KEY

SYMBOL NO.	LP-T6641
SM001	SKIP-/SEARCH+/PRESET+
SM002	SKIP+/SEARCH-/PRESET-
SM003	STOP
SM004	PAUSE/MONO-STEREO
SM005	PLAY
SM006	OPEN/CLOSE
SM007	STANBY

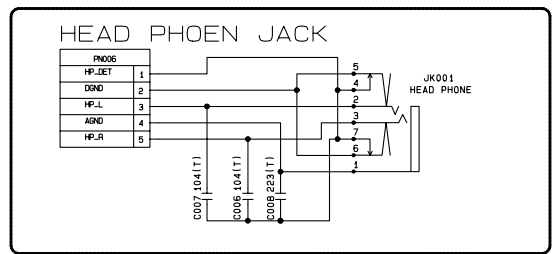
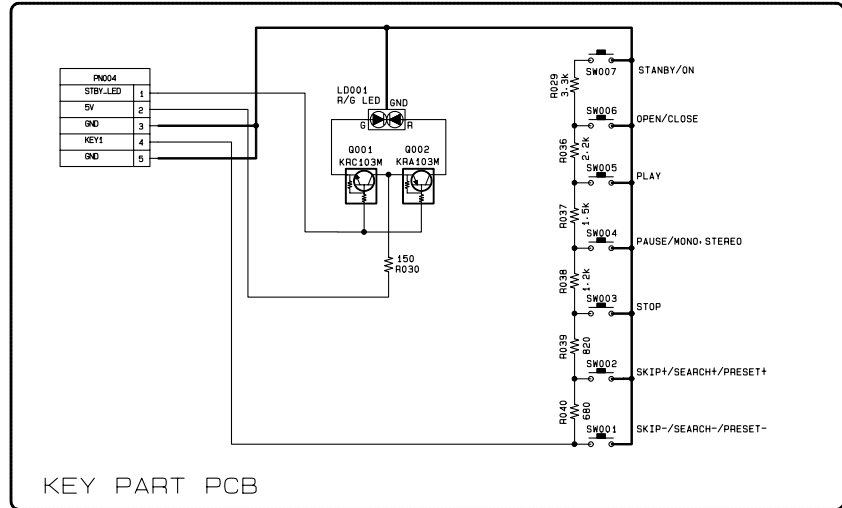
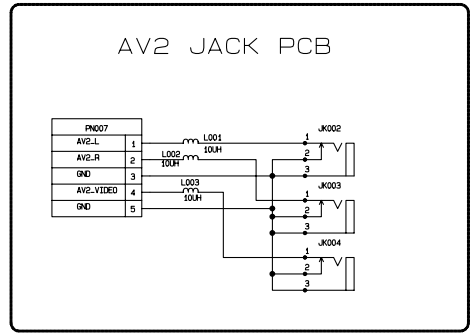
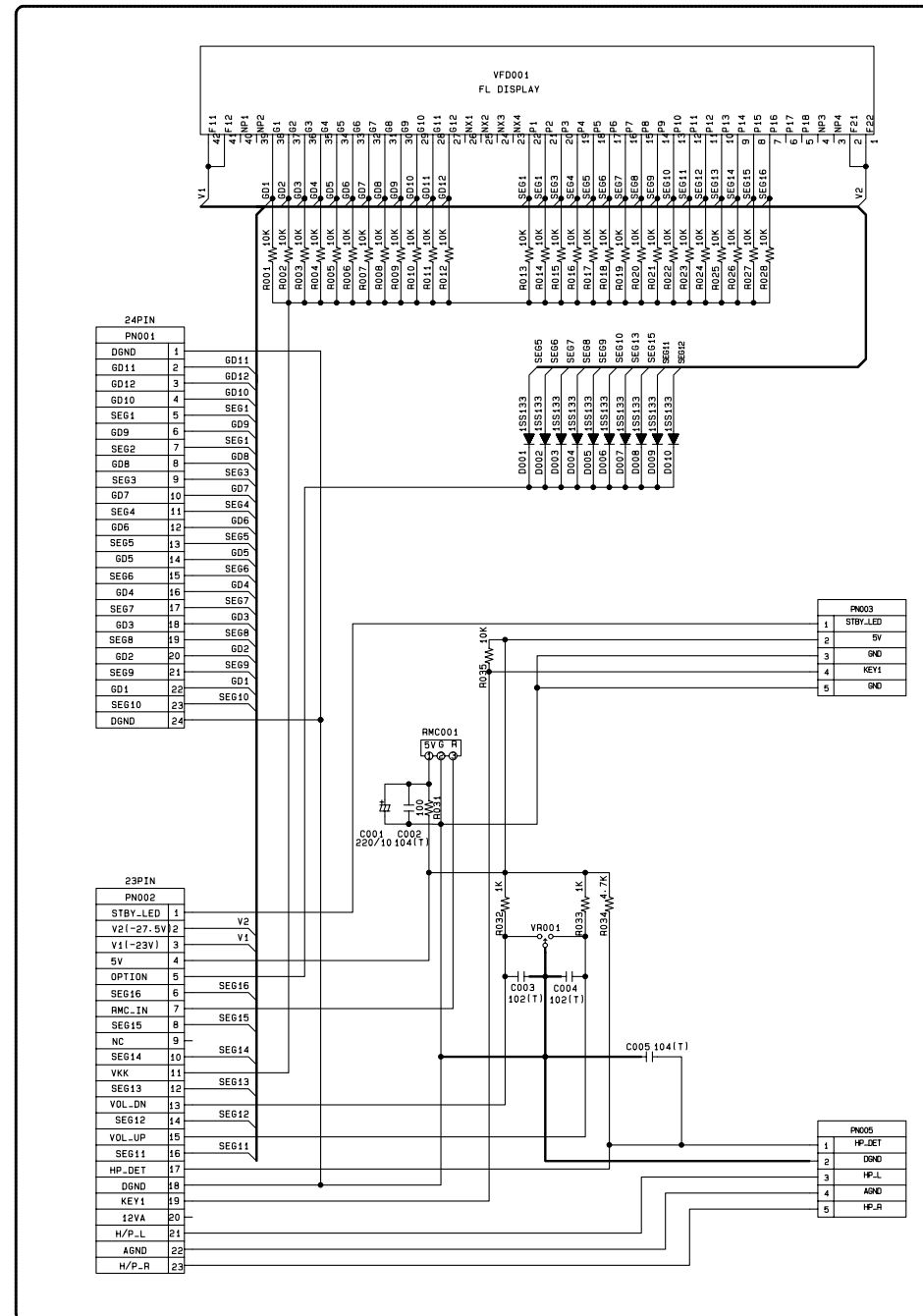

• MICOM SCHEMATIC DIAGRAM

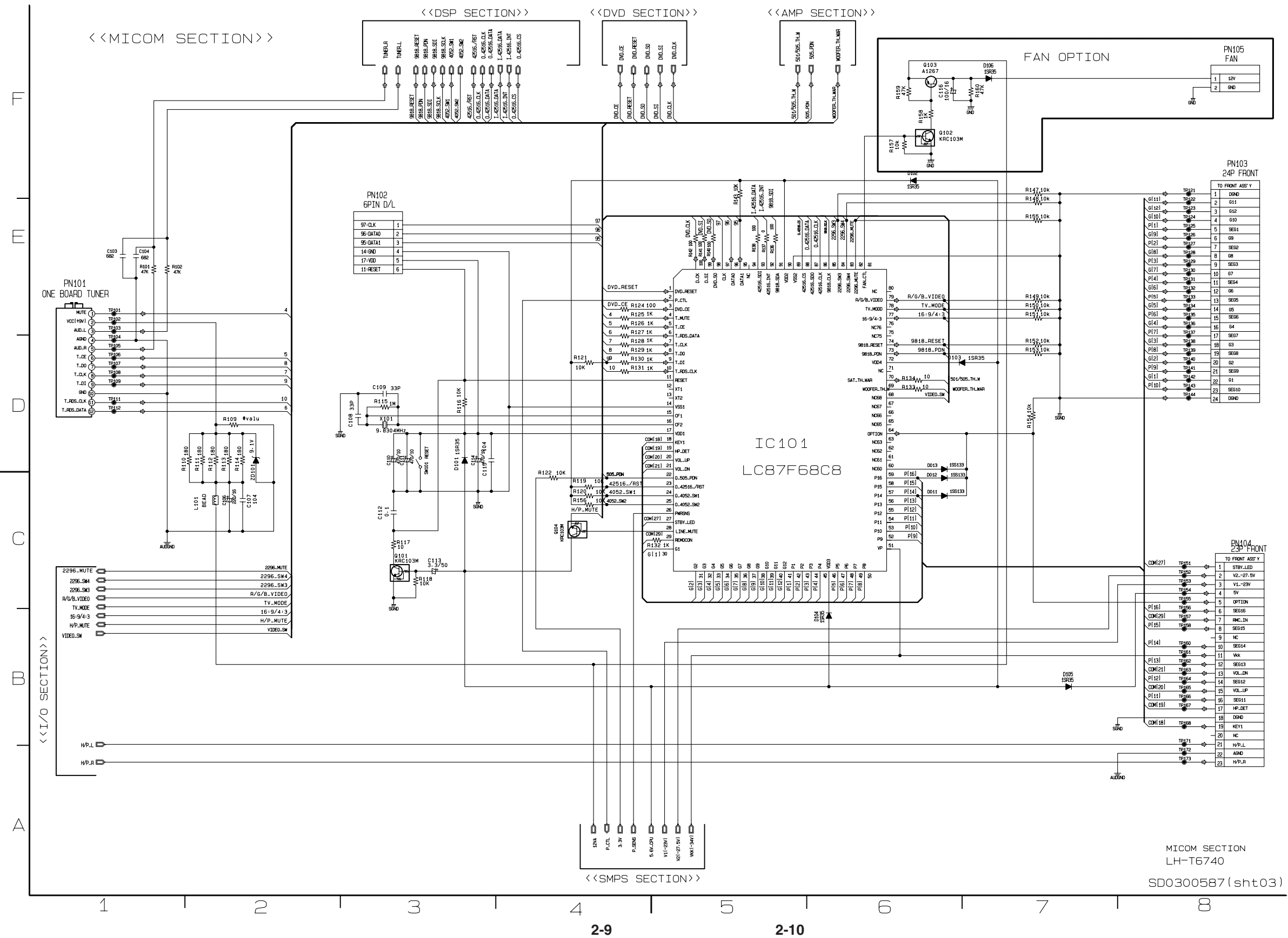

MICOM SECTION
LH-T6740
SD0300587(sht03)

• I/O SCHEMATIC DIAGRAM

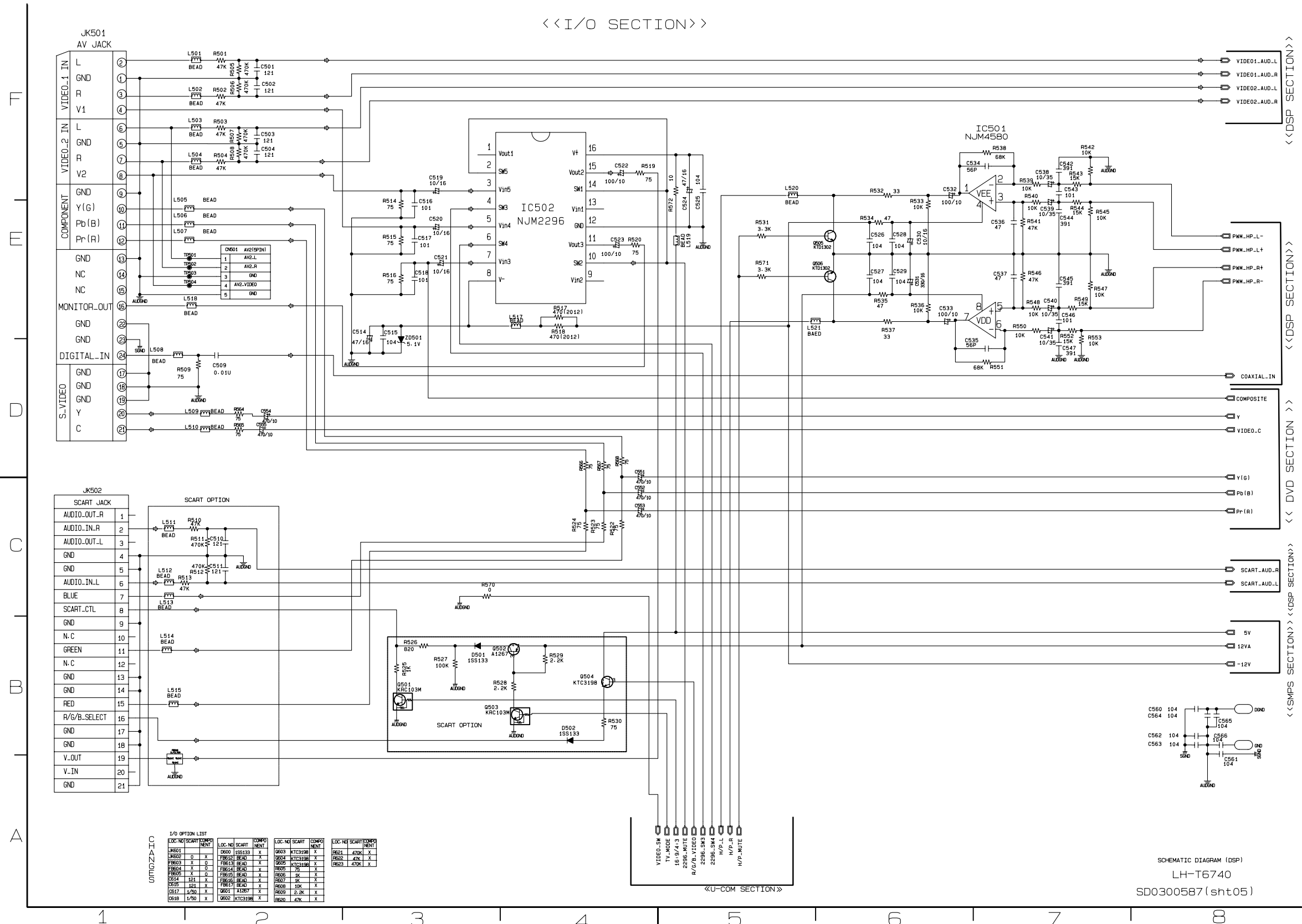

• DSP SCHEMATIC DIAGRAM

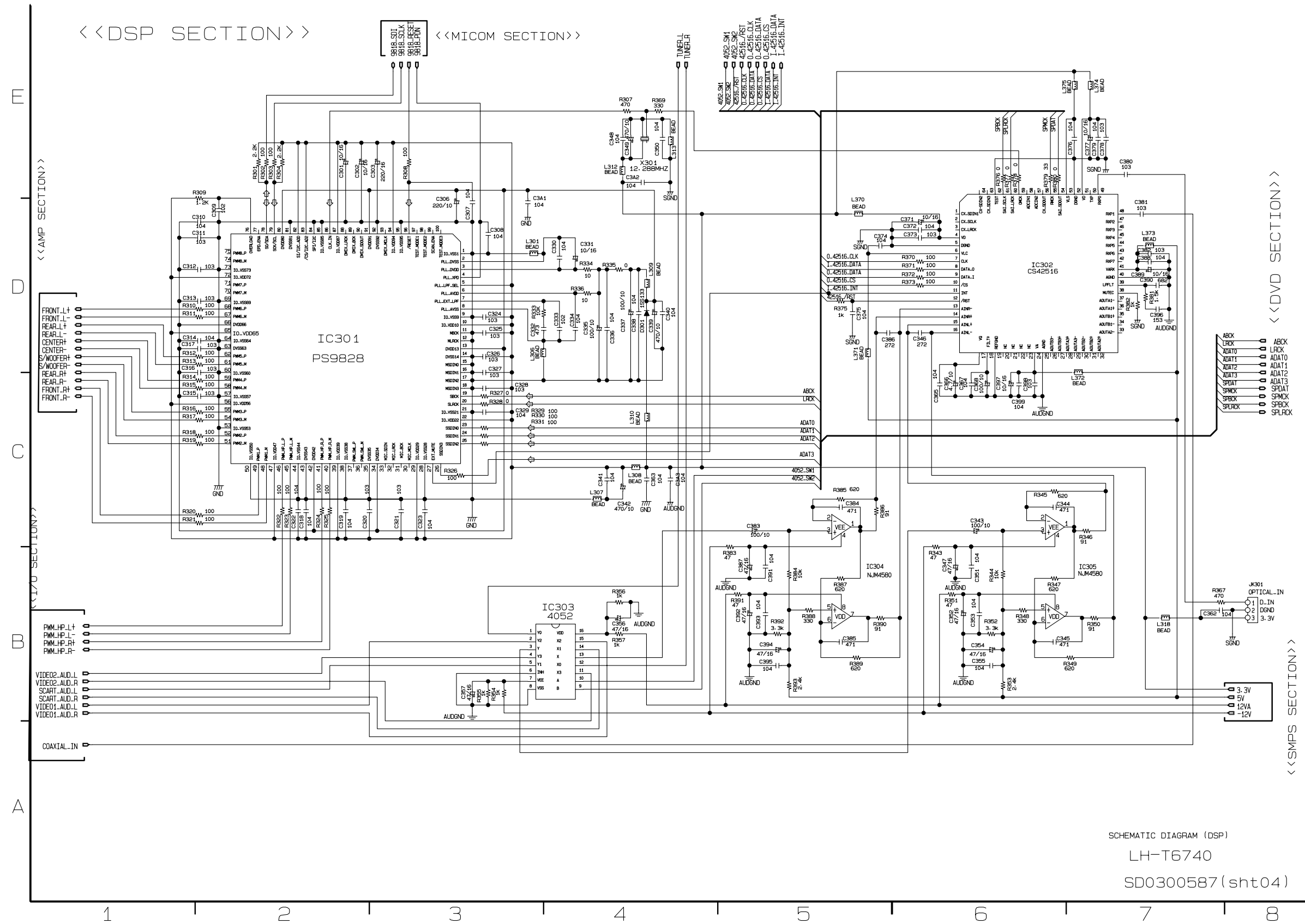

SCHEMATIC DIAGRAM (DSP)
LH-T6740
SD0300587(sht04)

• AMP SCHEMATIC DIAGRAM

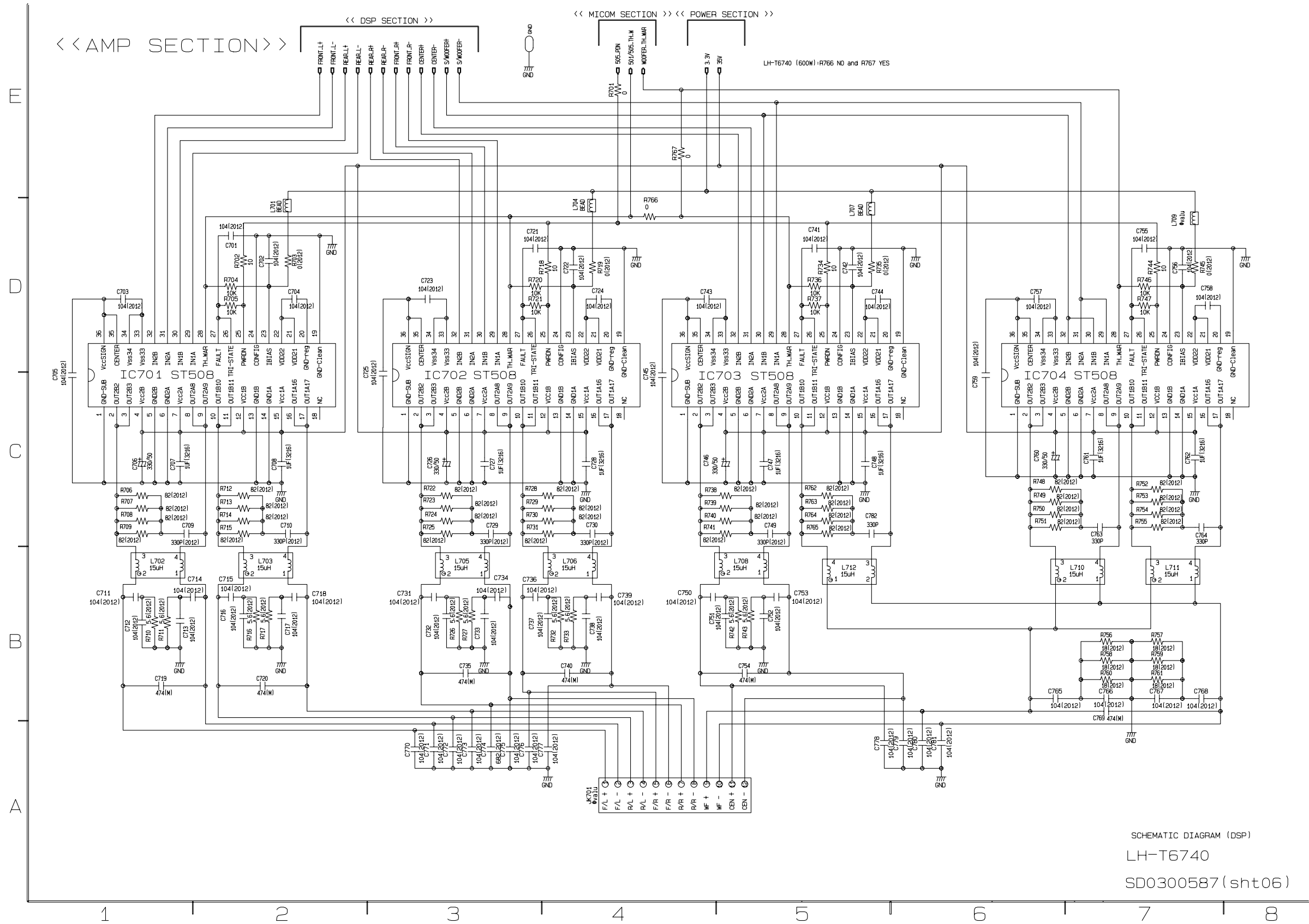

SCHEMATIC DIAGRAM (DSP)
 LH-T6740
 SD0300587(sht06)

• SMPS-WIDE SCHEMATIC DIAGRAM

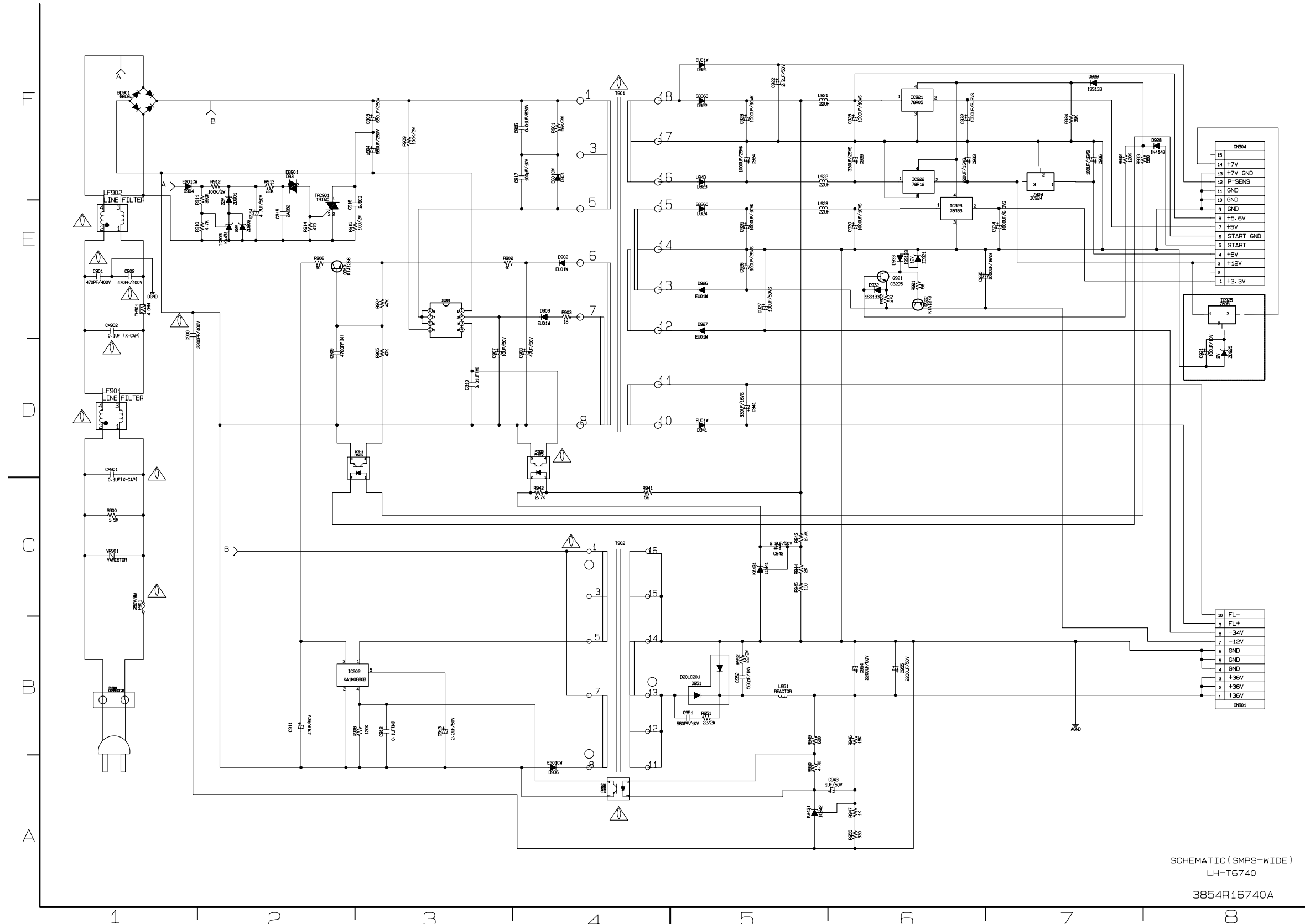

SCHEMATIC (SMPS-WIDE)
LH-T6740
3854R16740A

• POWER SCHEMATIC DIAGRAM

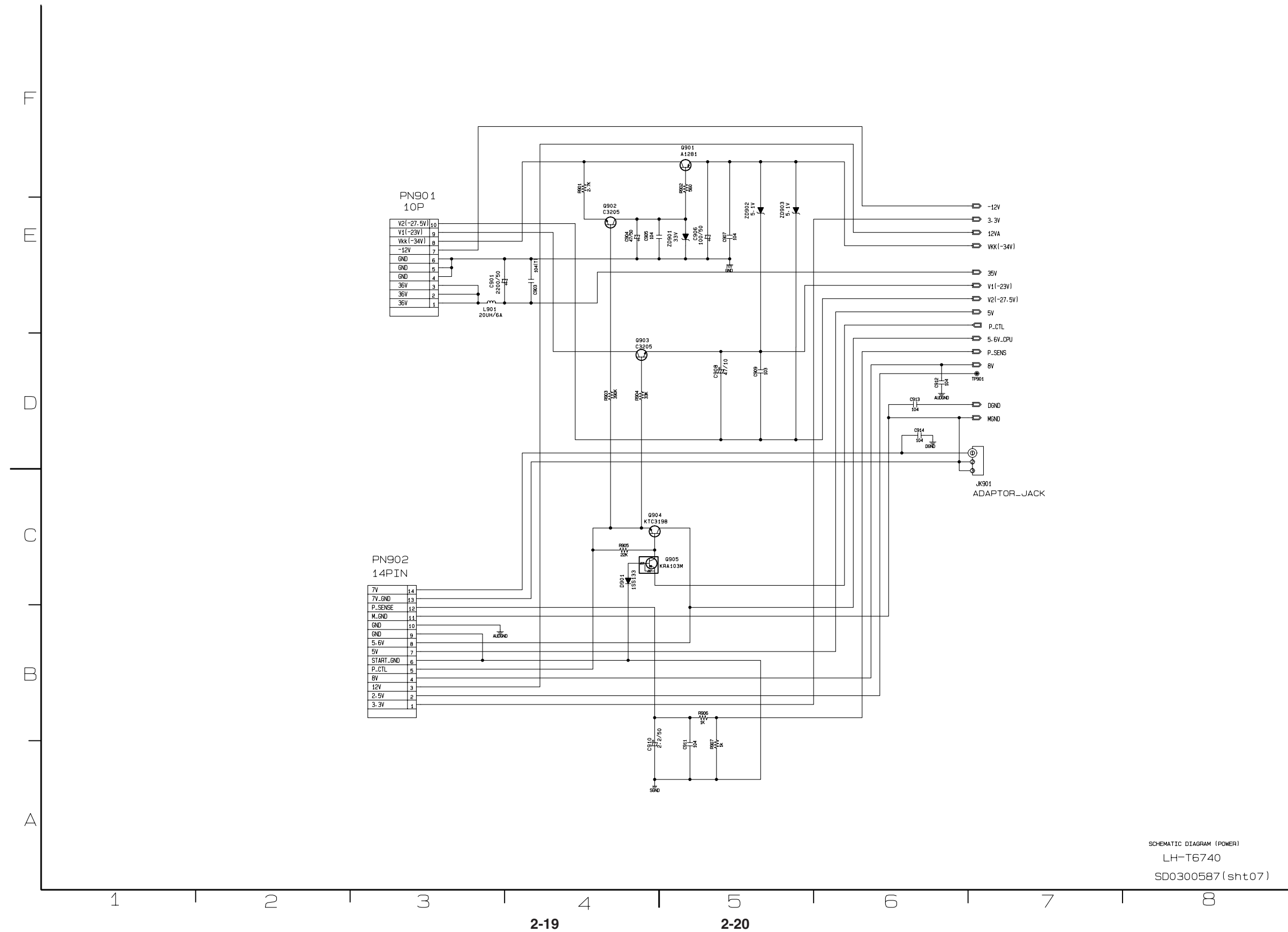

WIRING DIAGRAMS

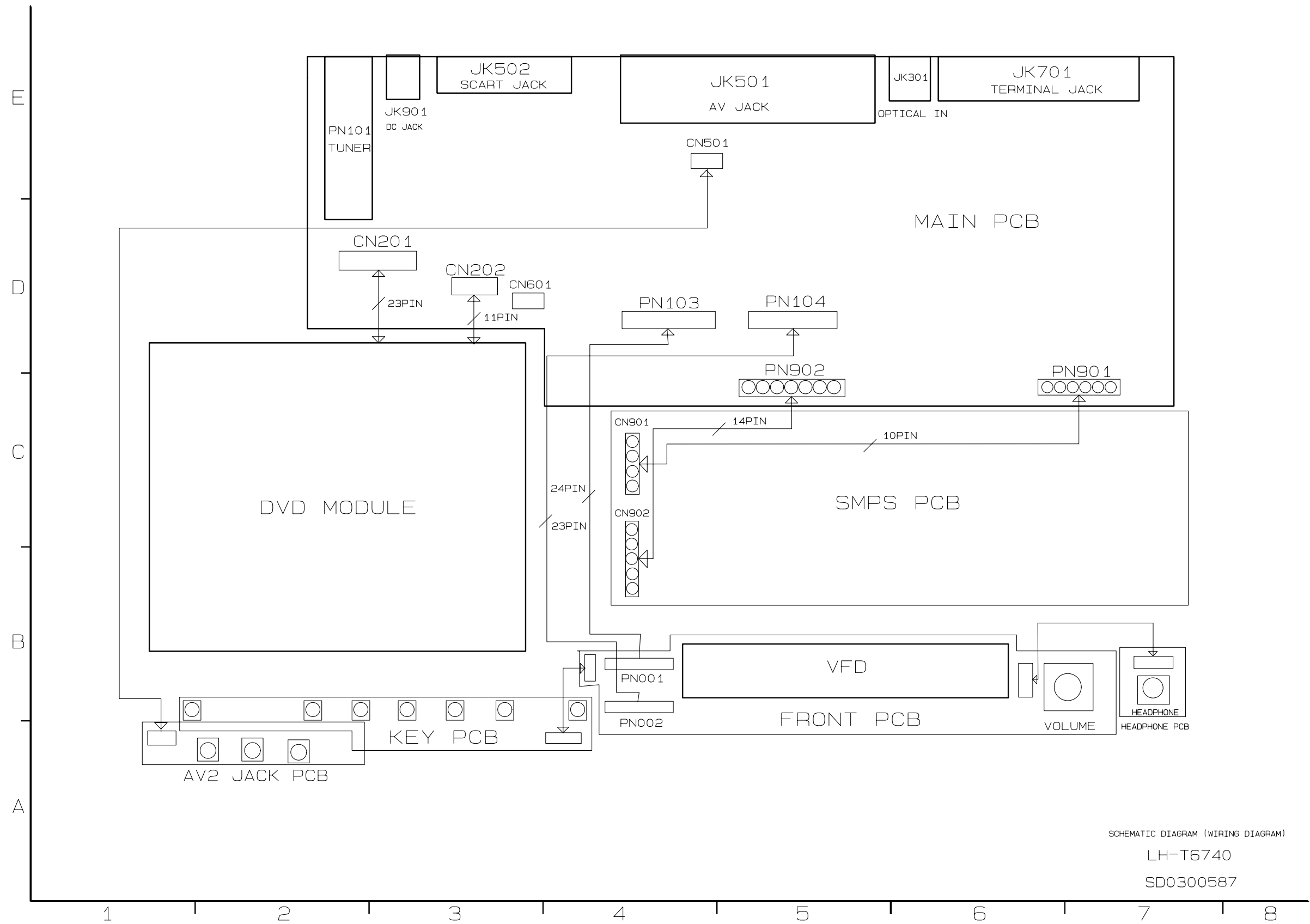

SCHEMATIC DIAGRAM (WIRING DIAGRAM)

LH-T6740

SD0300587

PRINTED CIRCUIT DIAGRAMS

MAIN P.C. BOARD (COMPONENT SIDE)

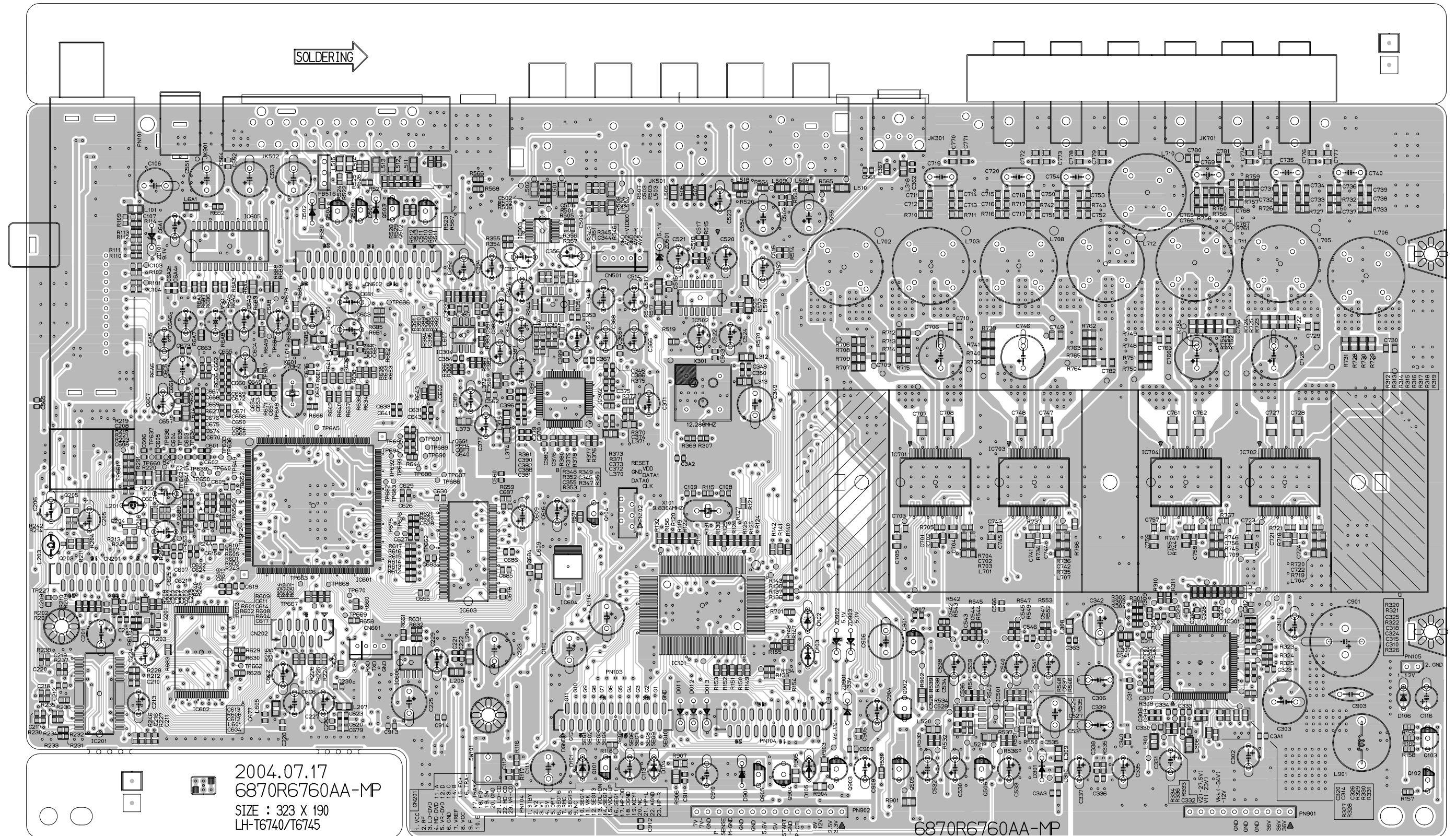

2004.07.17
6870R6760AA-MP
SIZE : 323 X 190
LH-T6740/T6745

- | | | |
|------|-----|-------|
| 1. | VCC | LN201 |
| 2. | VCC | LN202 |
| 3. | VCC | LN203 |
| 4. | VCC | LN204 |
| 5. | VCC | LN205 |
| 6. | VCC | LN206 |
| 7. | VCC | LN207 |
| 8. | VCC | LN208 |
| 9. | VCC | LN209 |
| 10. | VCC | LN210 |
| 11. | VCC | LN211 |
| 12. | VCC | LN212 |
| 13. | VCC | LN213 |
| 14. | VCC | LN214 |
| 15. | VCC | LN215 |
| 16. | VCC | LN216 |
| 17. | VCC | LN217 |
| 18. | VCC | LN218 |
| 19. | VCC | LN219 |
| 20. | VCC | LN220 |
| 21. | VCC | LN221 |
| 22. | VCC | LN222 |
| 23. | VCC | LN223 |
| 24. | VCC | LN224 |
| 25. | VCC | LN225 |
| 26. | VCC | LN226 |
| 27. | VCC | LN227 |
| 28. | VCC | LN228 |
| 29. | VCC | LN229 |
| 30. | VCC | LN230 |
| 31. | VCC | LN231 |
| 32. | VCC | LN232 |
| 33. | VCC | LN233 |
| 34. | VCC | LN234 |
| 35. | VCC | LN235 |
| 36. | VCC | LN236 |
| 37. | VCC | LN237 |
| 38. | VCC | LN238 |
| 39. | VCC | LN239 |
| 40. | VCC | LN240 |
| 41. | VCC | LN241 |
| 42. | VCC | LN242 |
| 43. | VCC | LN243 |
| 44. | VCC | LN244 |
| 45. | VCC | LN245 |
| 46. | VCC | LN246 |
| 47. | VCC | LN247 |
| 48. | VCC | LN248 |
| 49. | VCC | LN249 |
| 50. | VCC | LN250 |
| 51. | VCC | LN251 |
| 52. | VCC | LN252 |
| 53. | VCC | LN253 |
| 54. | VCC | LN254 |
| 55. | VCC | LN255 |
| 56. | VCC | LN256 |
| 57. | VCC | LN257 |
| 58. | VCC | LN258 |
| 59. | VCC | LN259 |
| 60. | VCC | LN260 |
| 61. | VCC | LN261 |
| 62. | VCC | LN262 |
| 63. | VCC | LN263 |
| 64. | VCC | LN264 |
| 65. | VCC | LN265 |
| 66. | VCC | LN266 |
| 67. | VCC | LN267 |
| 68. | VCC | LN268 |
| 69. | VCC | LN269 |
| 70. | VCC | LN270 |
| 71. | VCC | LN271 |
| 72. | VCC | LN272 |
| 73. | VCC | LN273 |
| 74. | VCC | LN274 |
| 75. | VCC | LN275 |
| 76. | VCC | LN276 |
| 77. | VCC | LN277 |
| 78. | VCC | LN278 |
| 79. | VCC | LN279 |
| 80. | VCC | LN280 |
| 81. | VCC | LN281 |
| 82. | VCC | LN282 |
| 83. | VCC | LN283 |
| 84. | VCC | LN284 |
| 85. | VCC | LN285 |
| 86. | VCC | LN286 |
| 87. | VCC | LN287 |
| 88. | VCC | LN288 |
| 89. | VCC | LN289 |
| 90. | VCC | LN290 |
| 91. | VCC | LN291 |
| 92. | VCC | LN292 |
| 93. | VCC | LN293 |
| 94. | VCC | LN294 |
| 95. | VCC | LN295 |
| 96. | VCC | LN296 |
| 97. | VCC | LN297 |
| 98. | VCC | LN298 |
| 99. | VCC | LN299 |
| 100. | VCC | LN300 |

6870R6760AA-MP

TOP-SOLBERN

• MAIN P.C. BOARD (SOLDER SIDE)

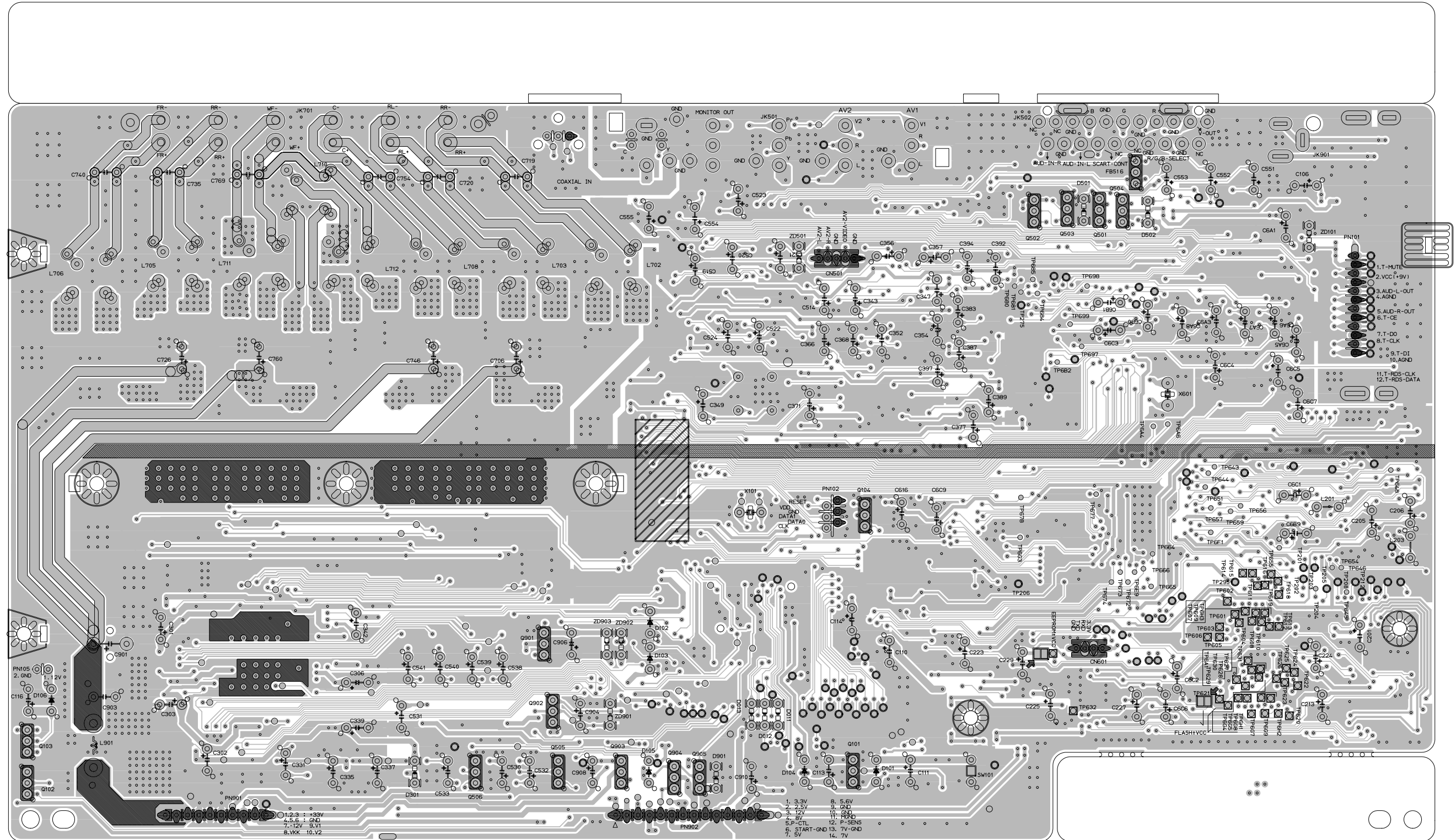

BOT BOTTOM+SIK

• FRONT P.C.BOARD (SOLDER SIDE)

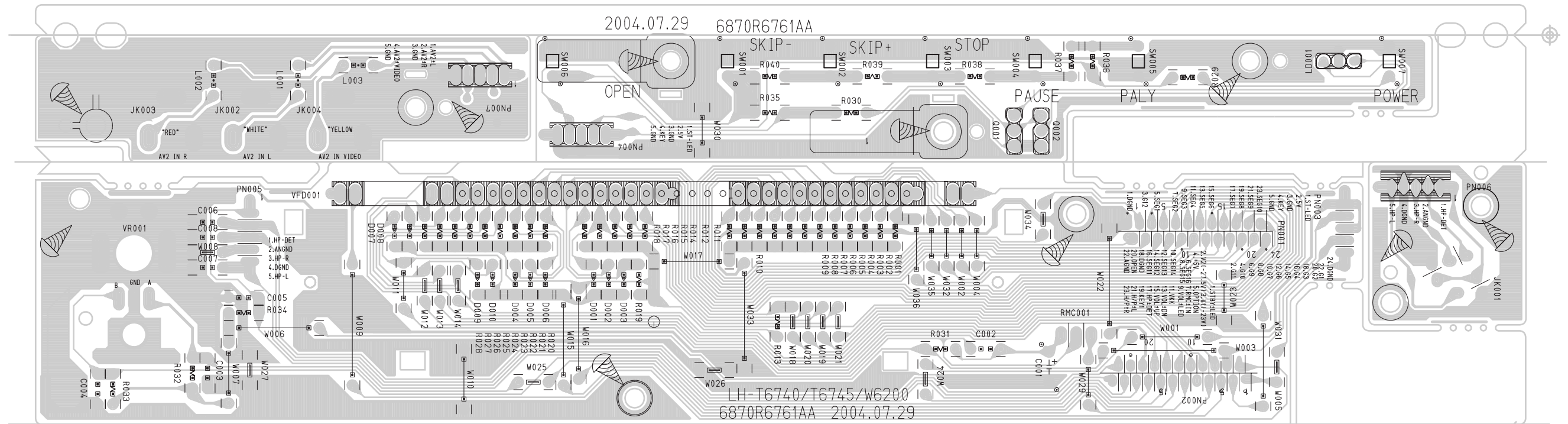

• FRONT P.C.BOARD (COMPONENT SIDE)

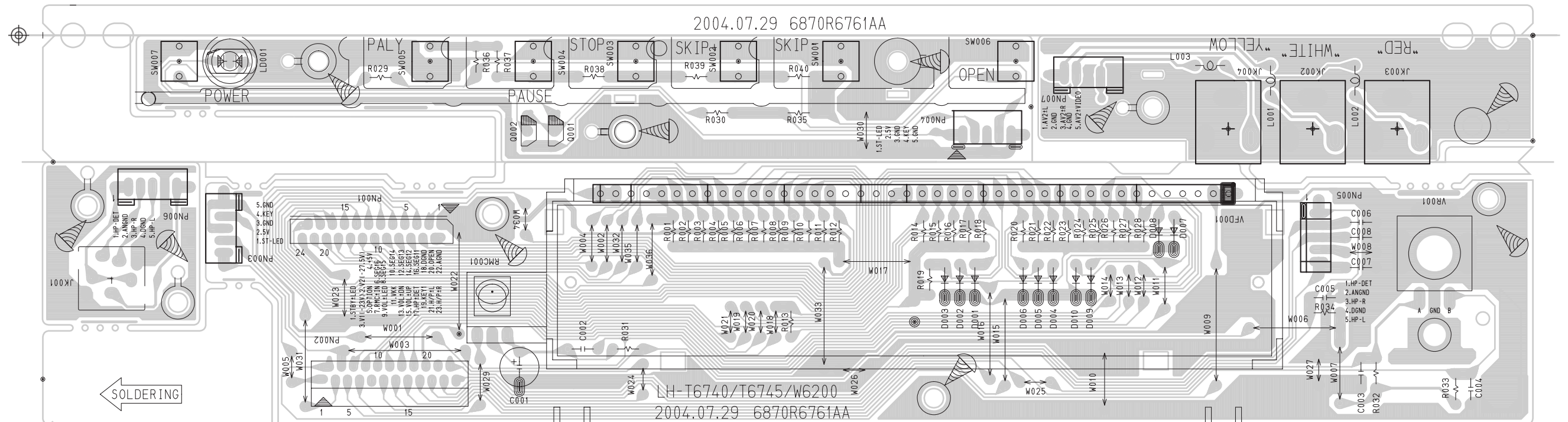

• POWER P.C.BOARD

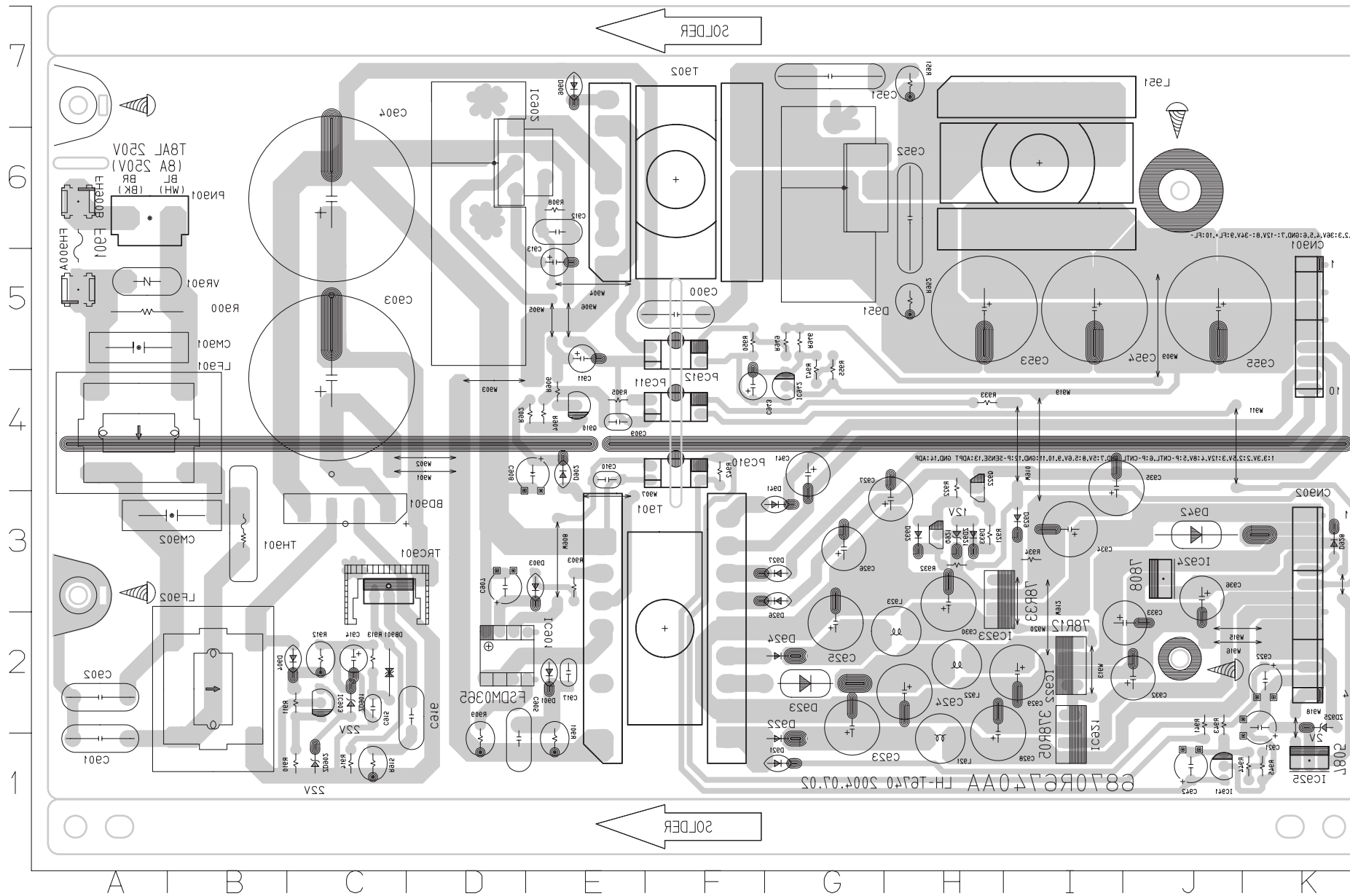

BD901	C3	CN902	K2	Q922	H4
C900	F5	D901	E2	R900	A5
C901	A1	D902	E4	R901	E1
C902	A2	D903	E3	R902	E4
C903	C4	D904	C2	R903	E3
C904	C6	D906	E7	R904	E4
C905	D1	D921	G1	R905	E4
C907	D3	D922	G1	R906	E4
C908	E4	D923	G2	R908	E6
C909	E4	D924	G2	R909	D1
C910	E4	D926	G3	R910	C1
C911	E5	D927	G3	R911	C2
C912	E6	D928	K3	R912	C2
C913	E5	D929	I3	R913	C2
C914	C2	D932	H3	R914	C1
C915	C2	D933	H3	R915	C1
C916	D2	D941	G3	R921	H3
C917	E2	D942	J3	R922	H4
C921	K2	D951	G6	R932	H3
C922	K2	DB901	C2	R933	H4
C923	G2	FH900A	A5	R934	I3
C924	H2	FH900B	A6	R941	J2
C925	G2	IC901	D2	R942	F4
C926	G3	IC902	D6	R943	J2
C927	H3	IC903	C2	R944	K1
C928	H1	IC921	I1	R945	K1
C929	I2	IC922	I2	R946	G5
C930	H3	IC923	H3	R947	G4
C932	J2	IC924	J3	R949	G5
C933	J2	IC925	K1	R950	F5
C934	I3	IC941	J1	R951	H7
C935	I4	IC942	G4	R952	H5
C936	J3	L921	H1	R955	G4
C941	G4	L922	H2	T901	F2
C942	J1	L923	H2	T902	F6
C943	F4	L951	I6	TH901	B3
C951	G7	LF901	A4	TRC901	C3
C952	H6	LF902	B2	VR901	A5
C953	H5	PC910	F4	ZD901	C2
C954	I5	PC911	F4	ZD902	C1
C955	J5	PC912	F5	ZD921	H3
CM901	A5	PN901	A6	ZD925	K2
CM902	B3	Q910	E4		
LN901	K5	Q921	H3		

MEMO

MEMO

SECTION 3. DVD PART

ELECTRICAL TROUBLESHOOTING GUIDE

1. Power check flow

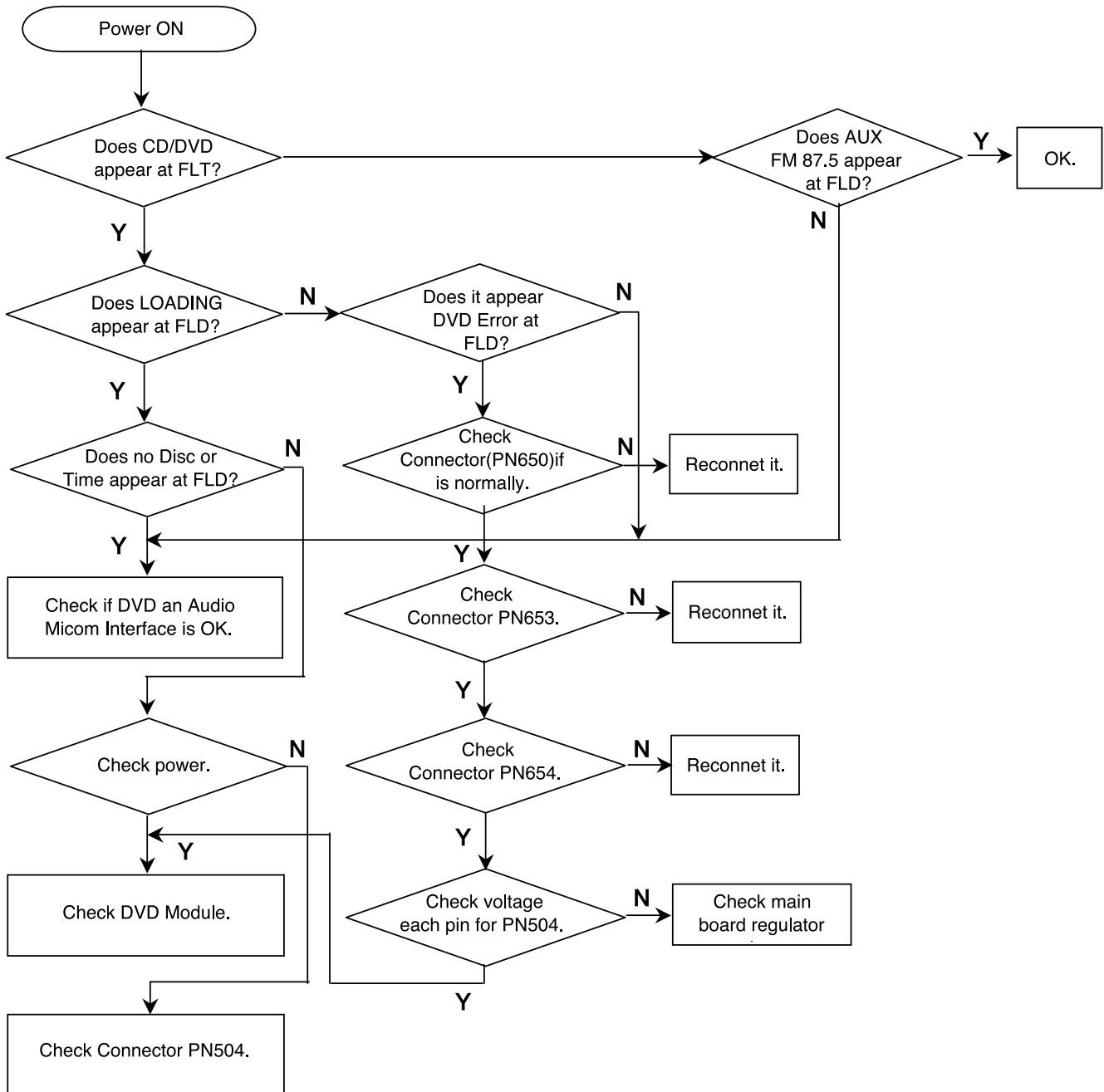

2. System operation flow

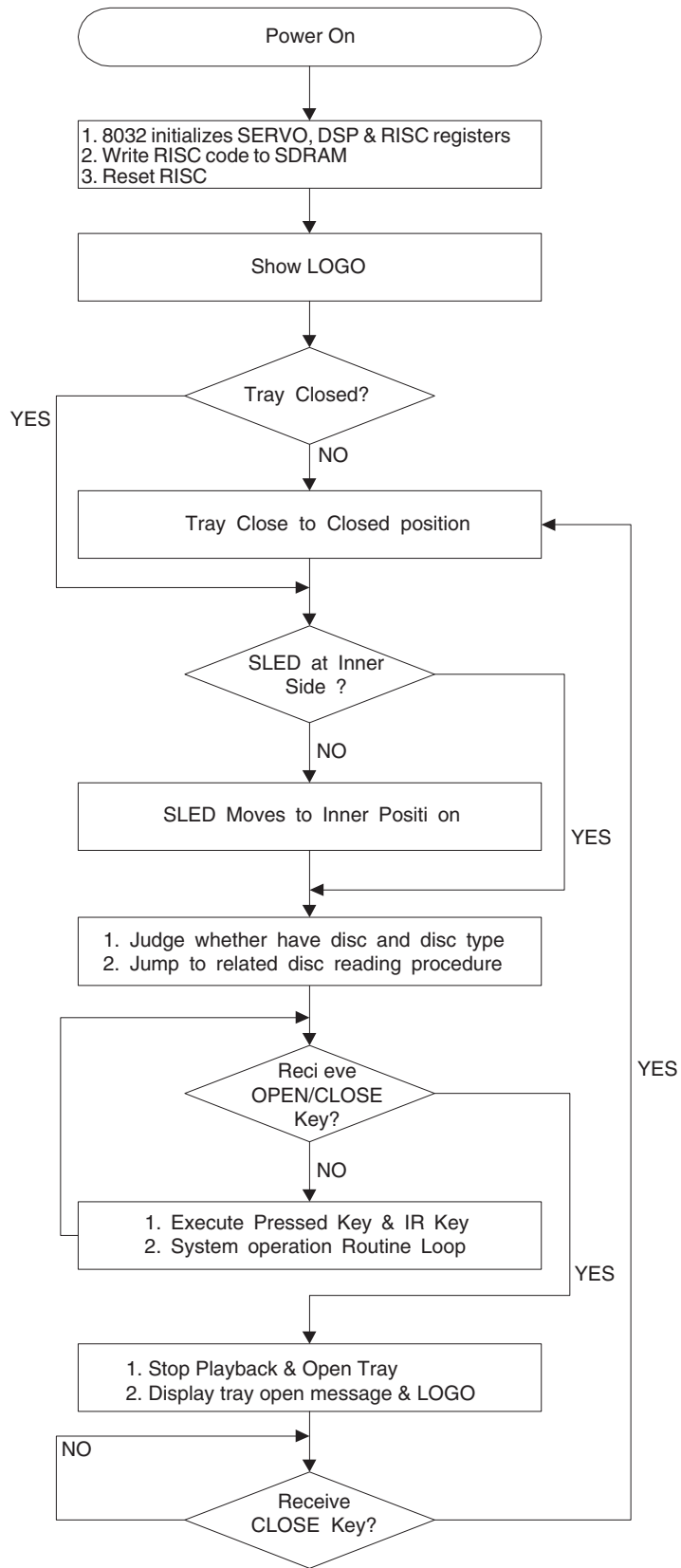

3. Test & debug flow

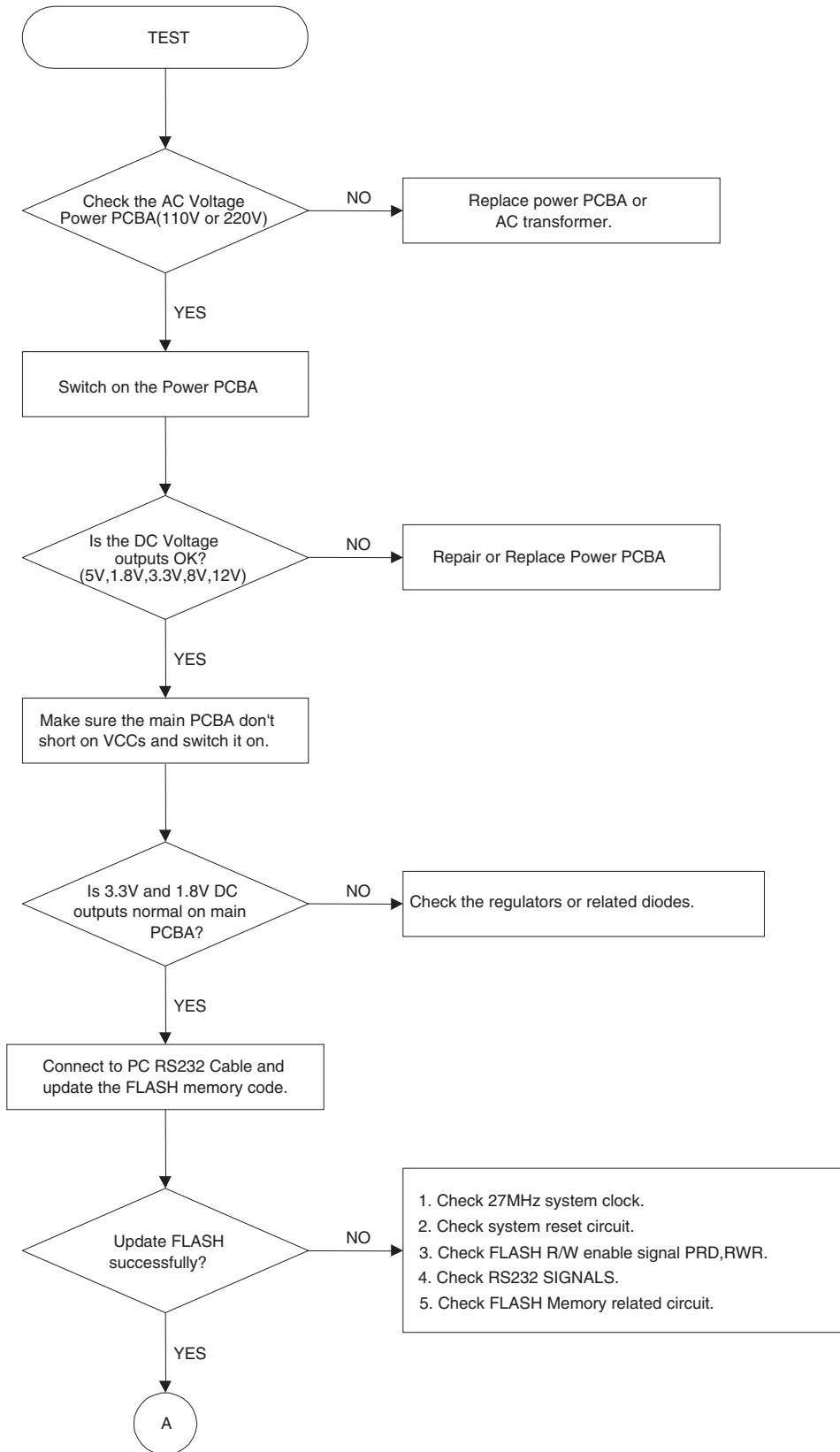

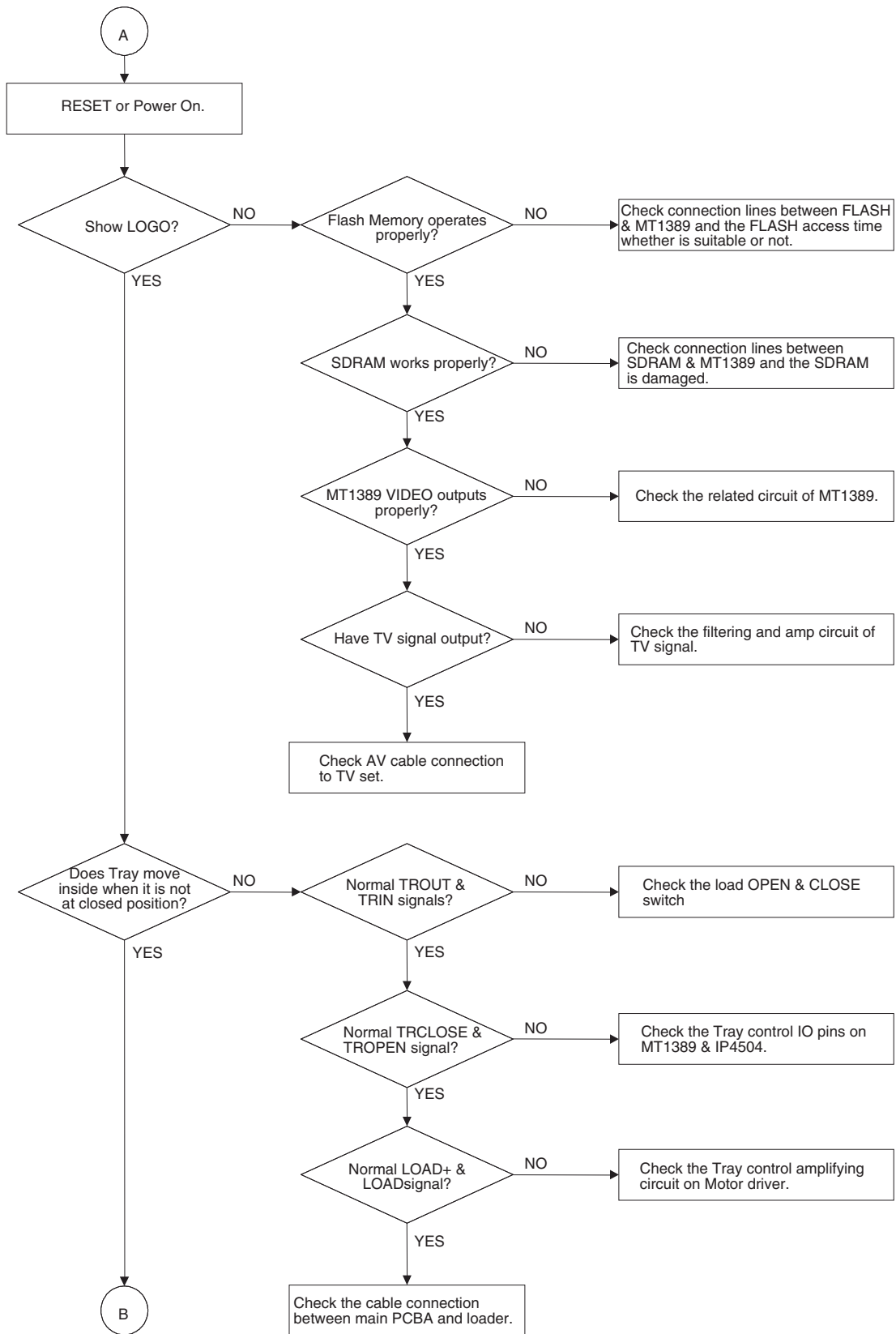

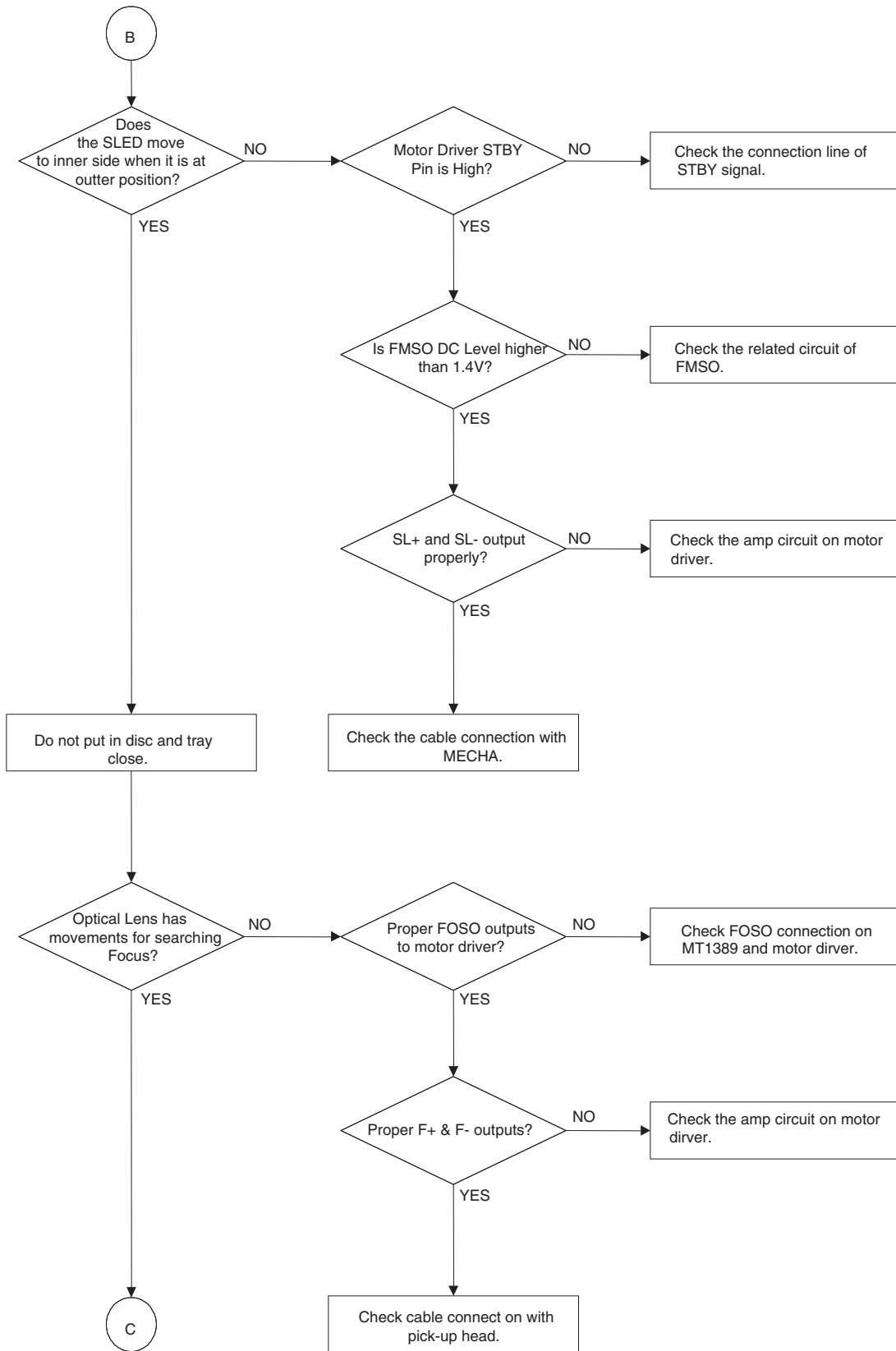

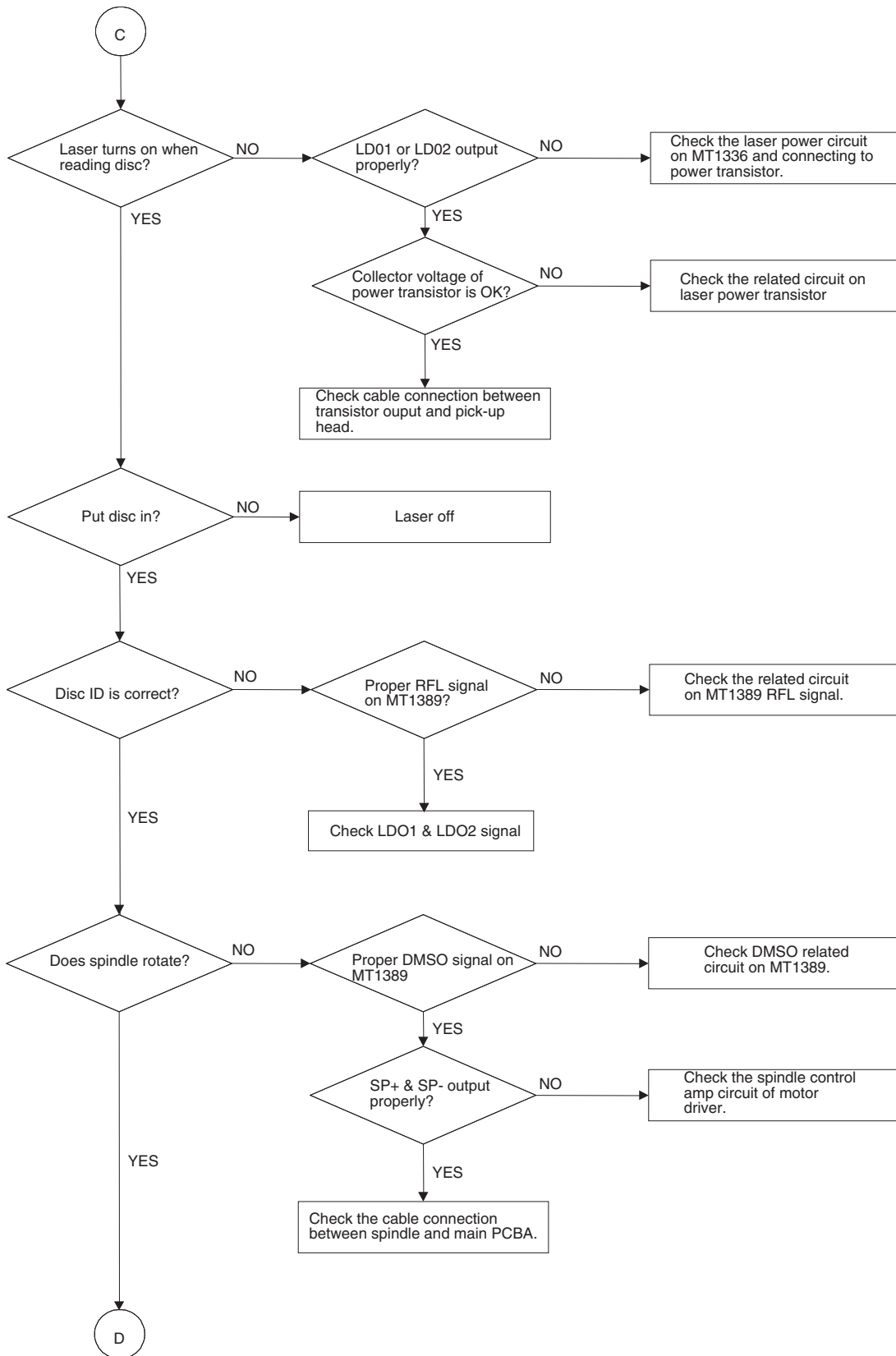

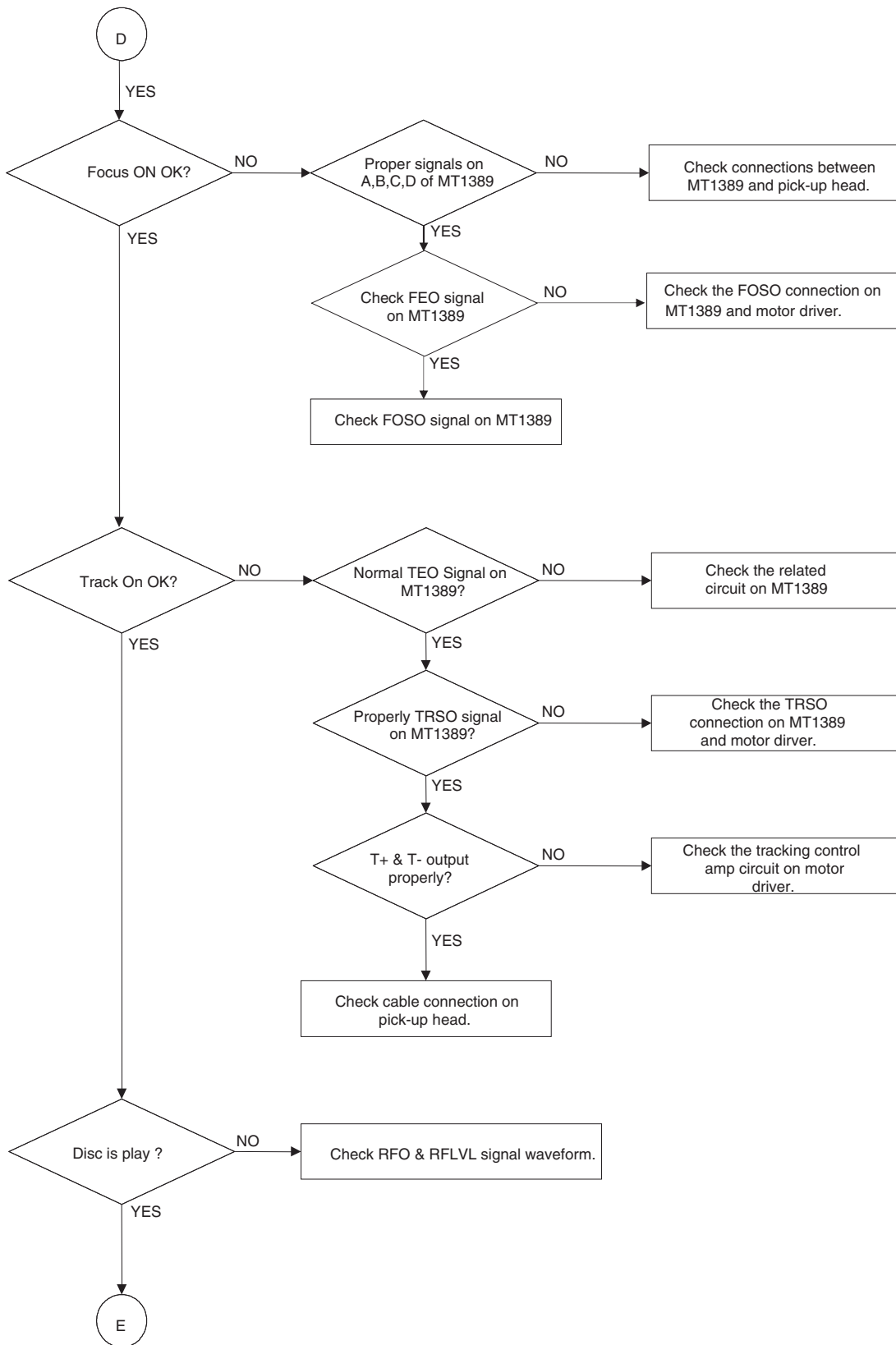

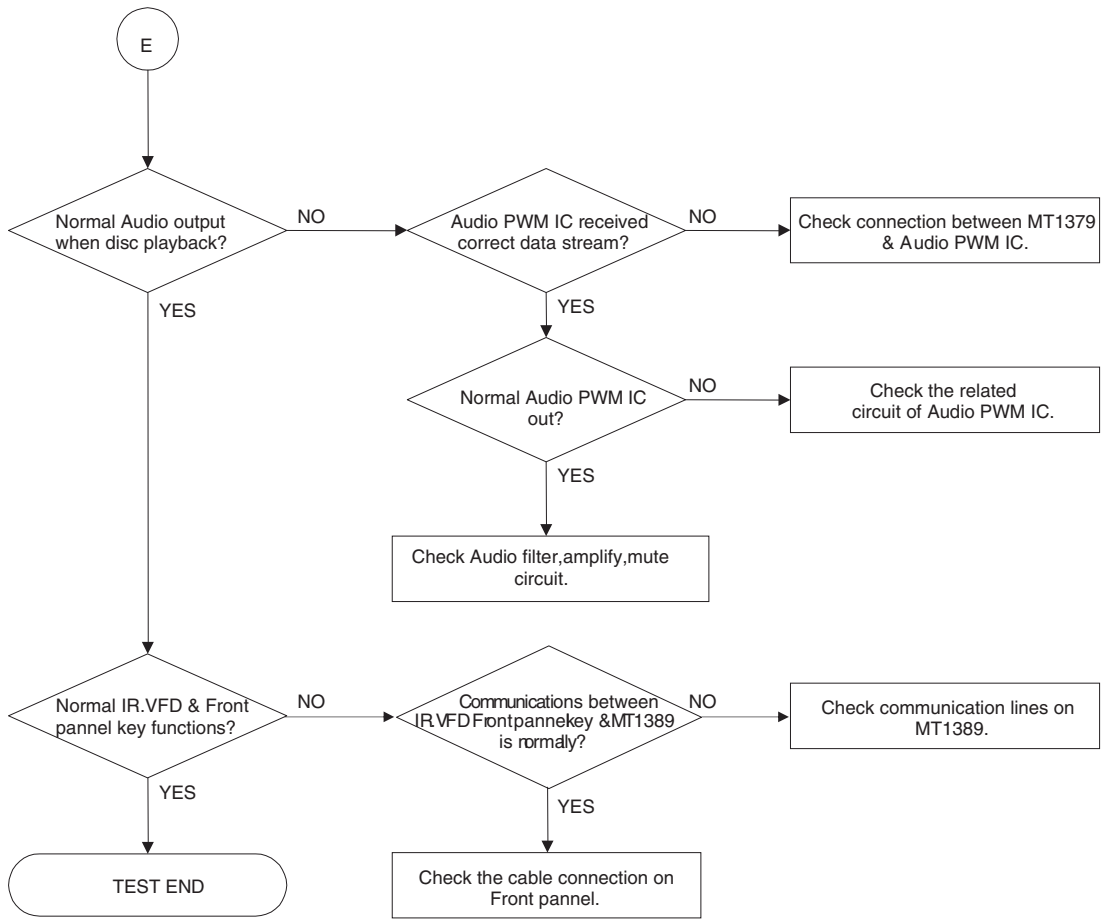

□ DETAILS AND WAVEFORMS ON SYSTEM TEST AND DEBUGGING

1. SYSTEM 27MHz CLOCK,RESET,FLASH R/W SIGNAL

1) MT1379 main clock is at 27MHz(X501)

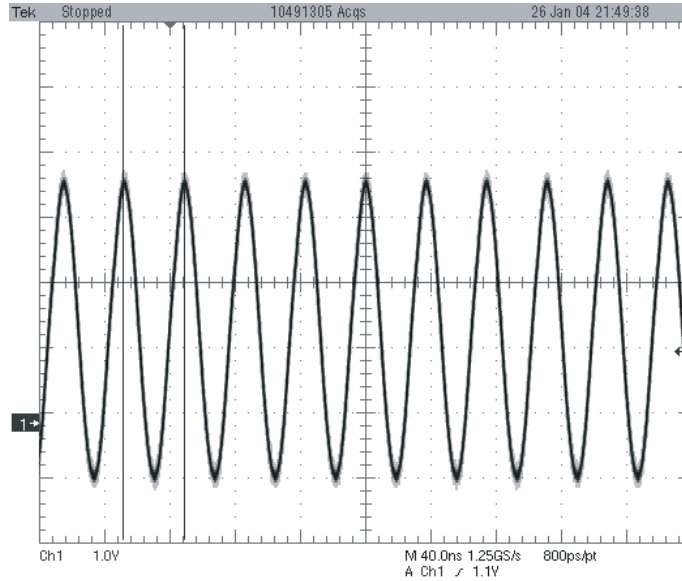

FIG 1-1

2) MT1336 reset is high active

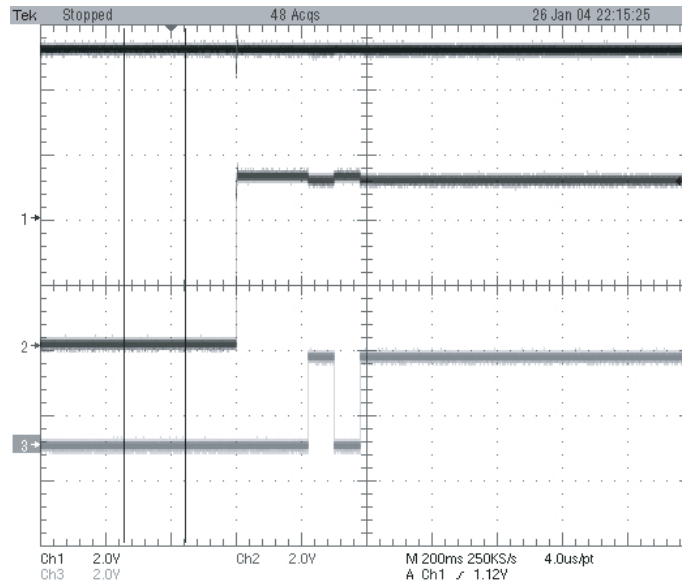

FIG 1-2

3) RS232 waveform during procedure(Downloading)

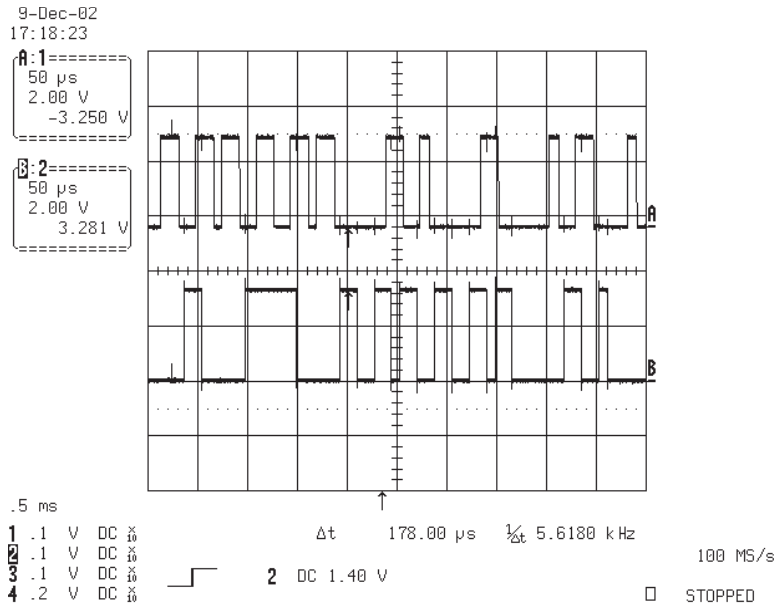

FIG 1-3

4) Flash R/W enable signal during download(Downloading)

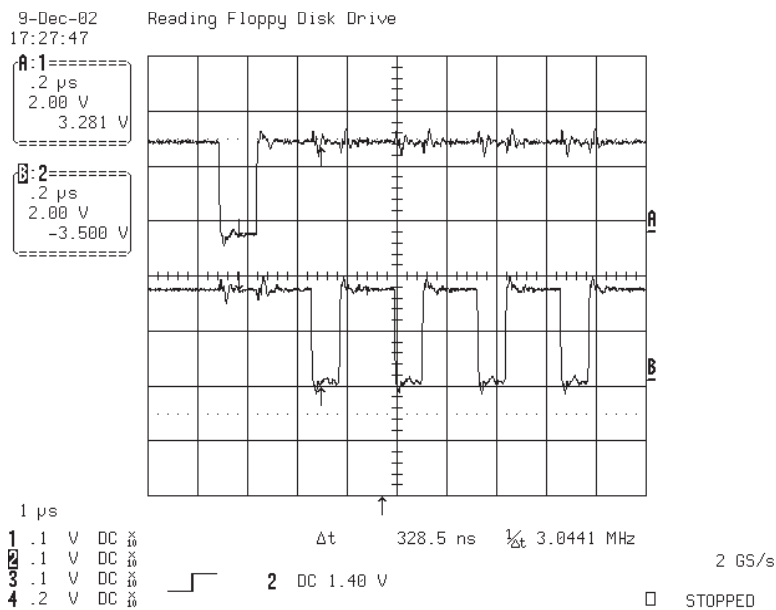

FIG 1-4

2. SDRAM CLOCK

1) MT1379 main clock is at 27MHz(X501)

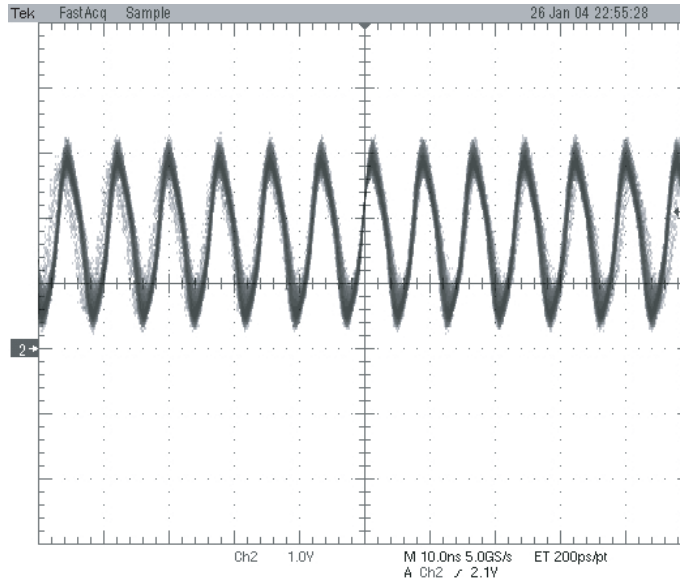

FIG 2-1

3. TRAY OPEN/CLOSE SIGNAL

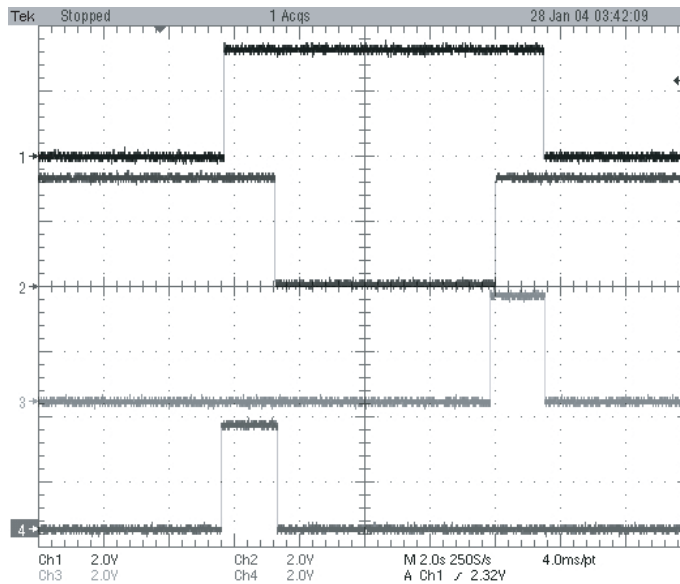

FIG 3-1

4. SLED CONTROL RELATED SIGNAL (NO DISC CONDITION)

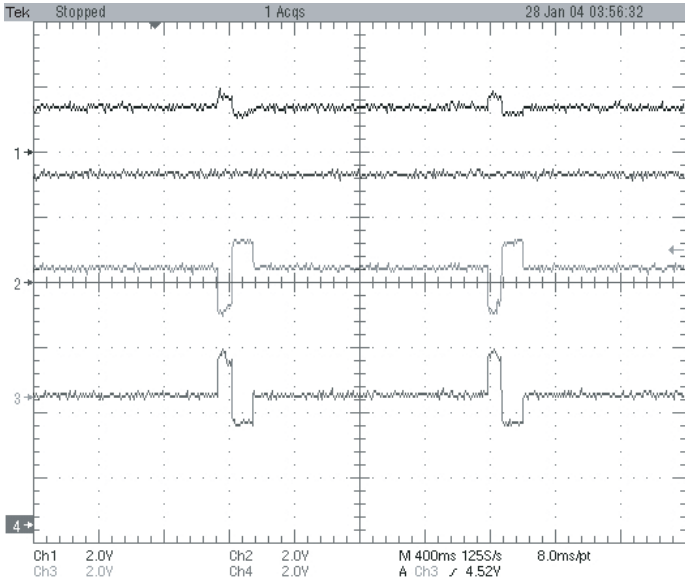

FIG 4-1

5. LENS CONTROL RELATED SIGNAL (NO DISC CONDITION)

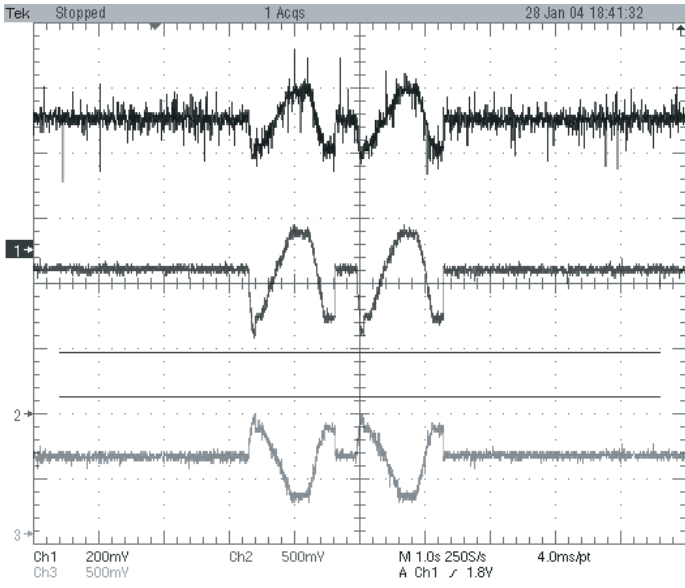

FIG 5-1

6. LASER POWER CONTROL RELATED SIGNAL (NO DISC CONDITION)

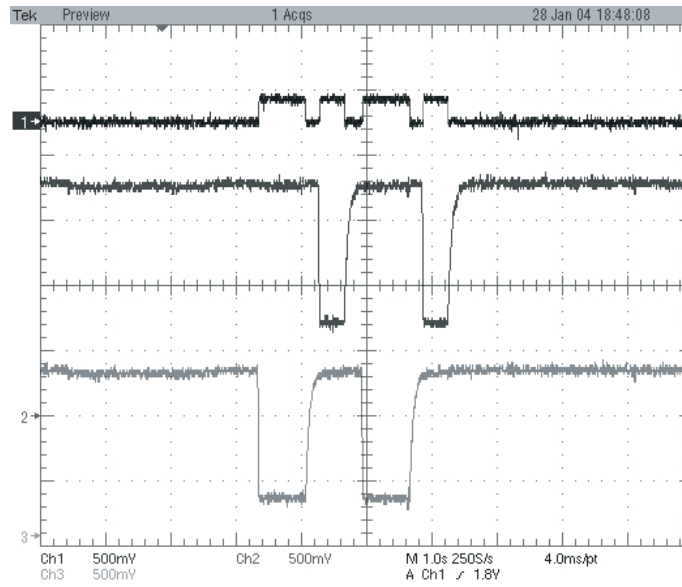

FIG 6-1

7. DISC TYPE JUDGEMENT W VEFORM

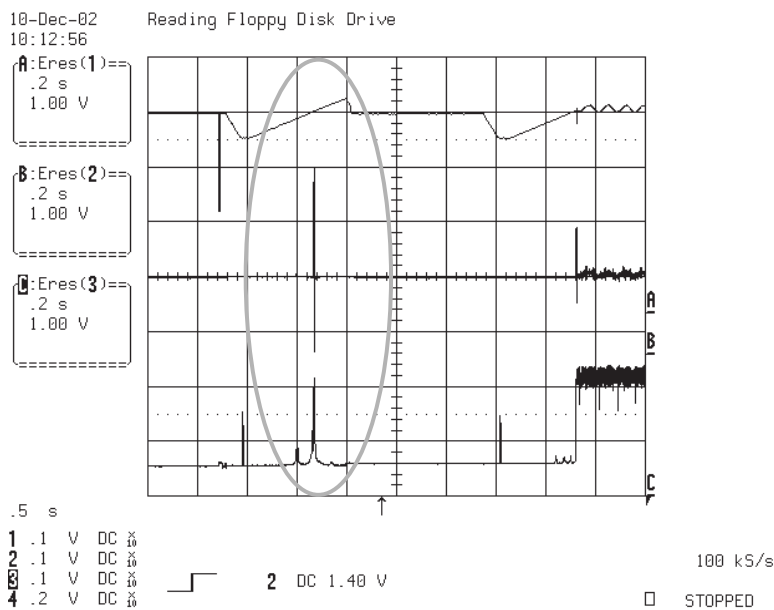

FIG 7-1

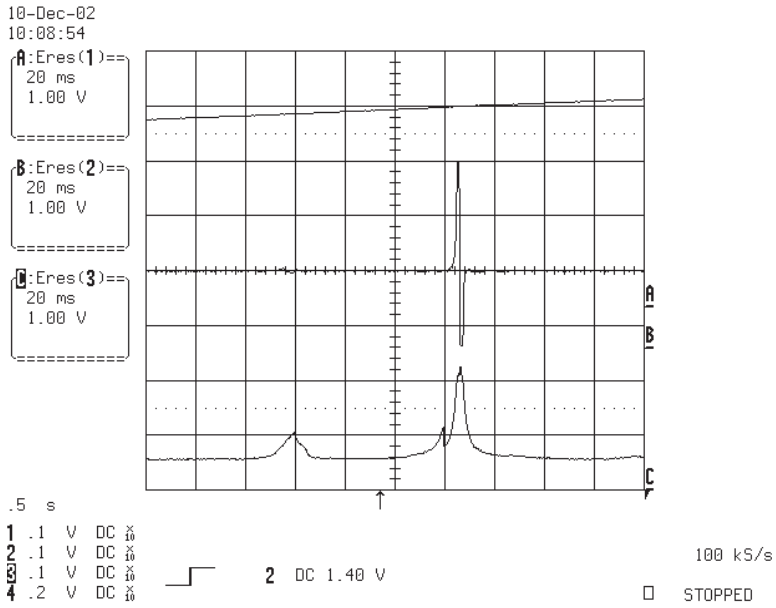

FIG 7-2 (DVD)

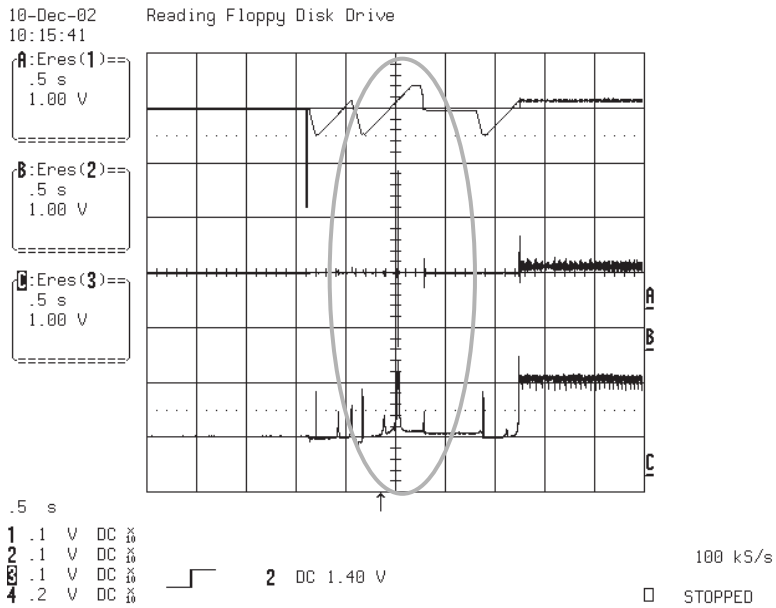

FIG 7-3 (CD)

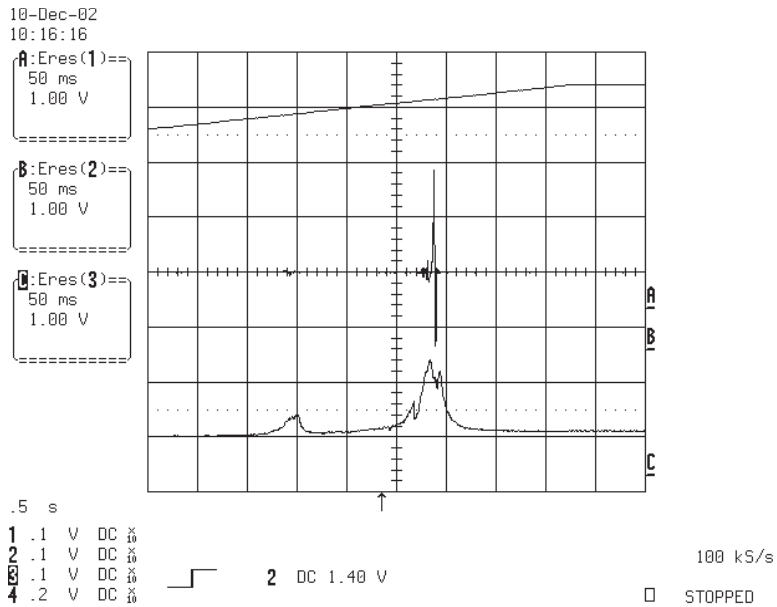

FIG 7-4 (CD)

8. FOCUS ON W VEFORM

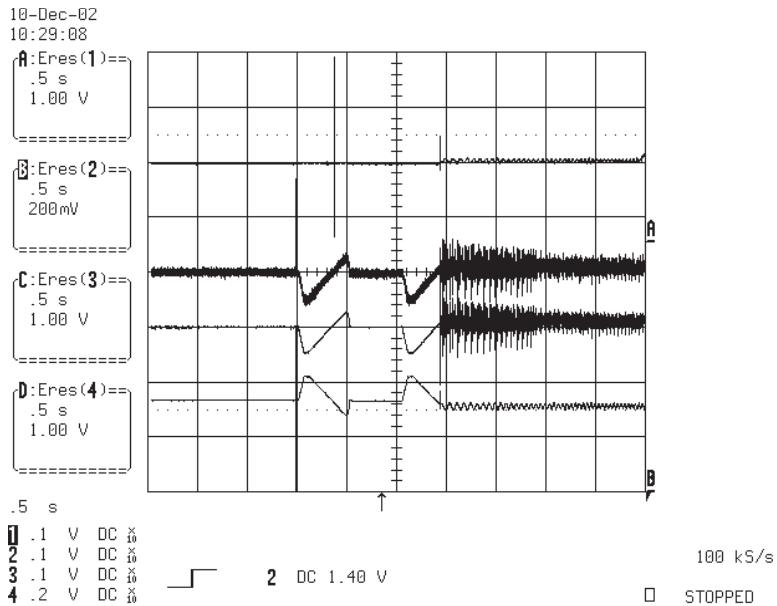

FIG 8-1 (DVD)

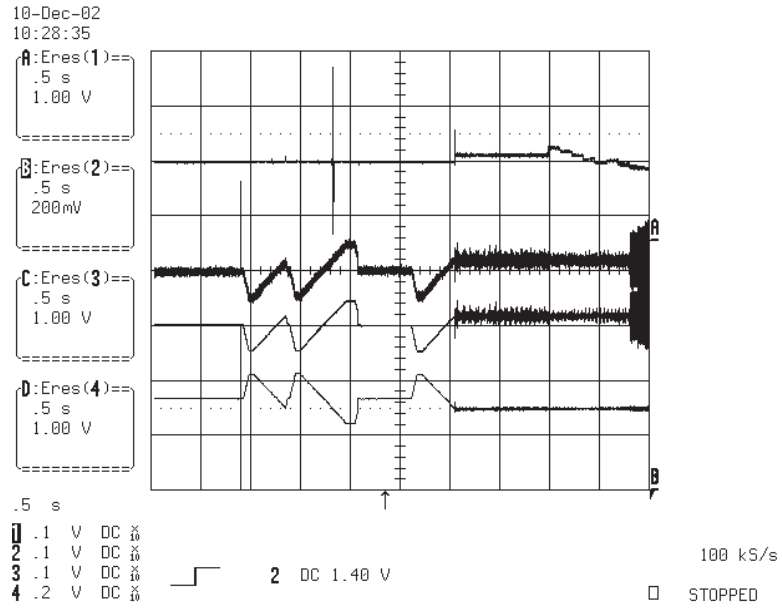

FIG 8-2 (CD)

9. SPINDLE CONTROL W VEFORM (NO DISC CONDITION)

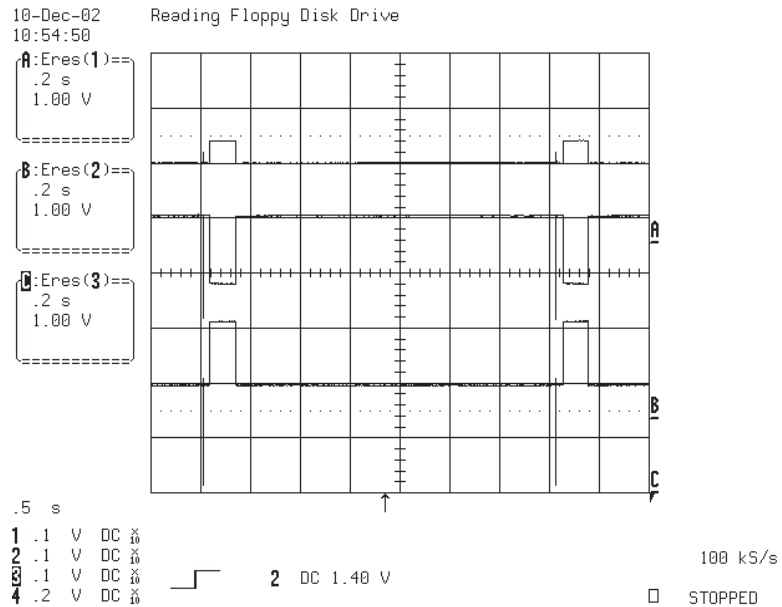

FIG 9-1

10. TRACKING CONTROL RELATED SIGNAL(System checking)

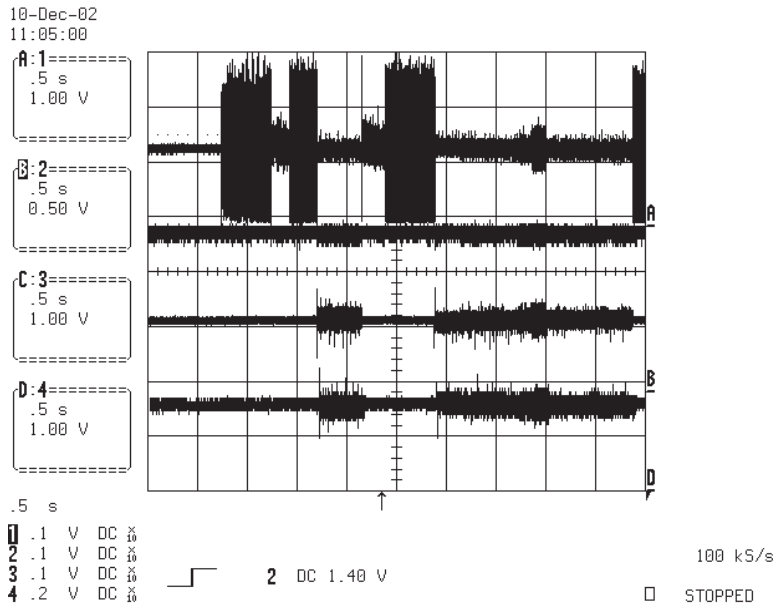

FIG 10-1 (DVD)

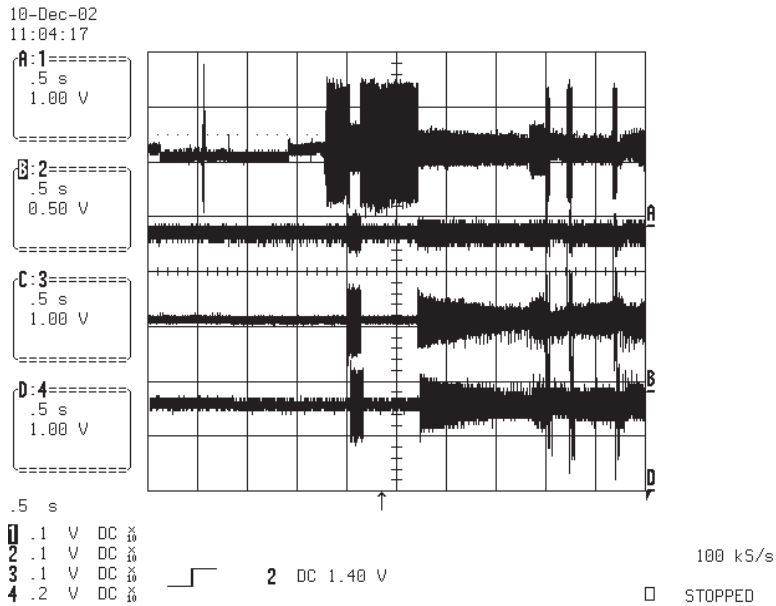

FIG 10-2 (CD)

11. MT1389 AUDIO OPTICAL AND COAXIAL INPUT (SPDIF)

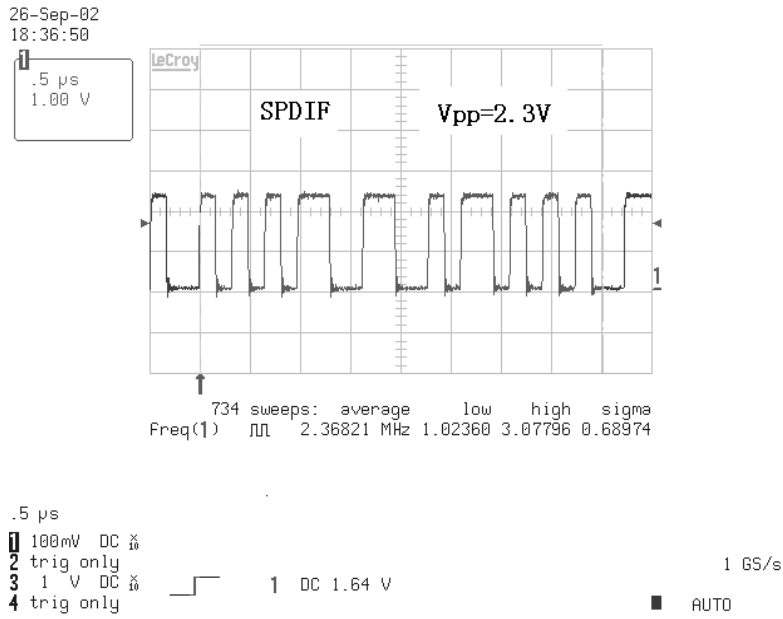

FIG 11-1 (DVD)

12. MT1389 VIDEO OUTPUT WAVEFORM

1)100%

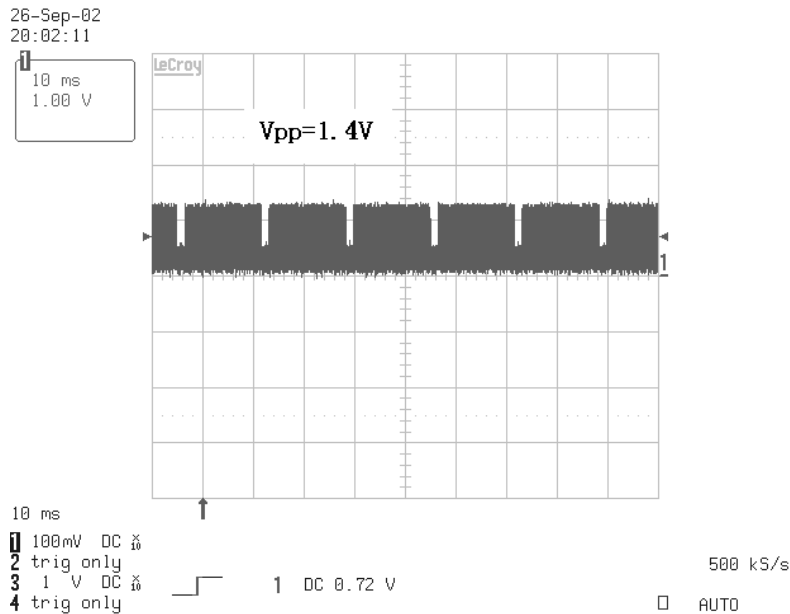

FIG 12-1

2) COMPOSITE VIDEO SIGNAL

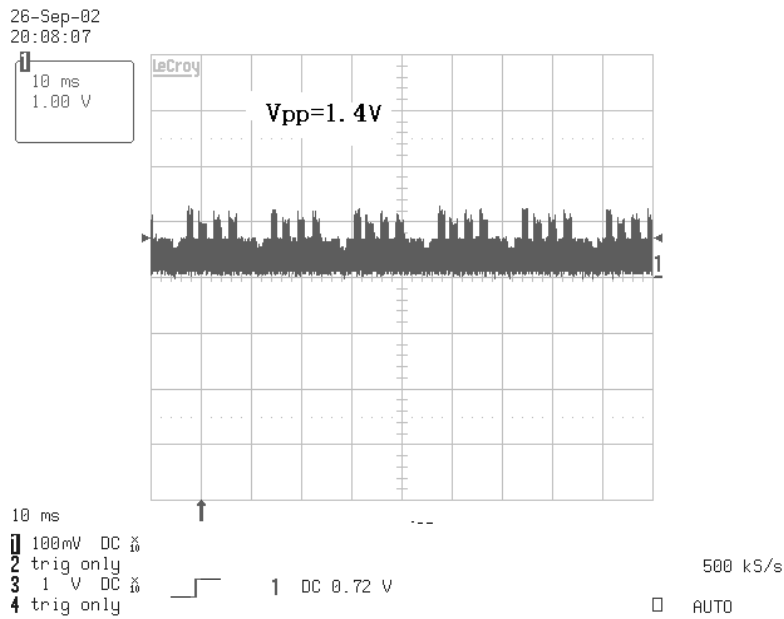

FIG 12-2

13. MT1389 AUDIO OUTPUT TO PWM IC

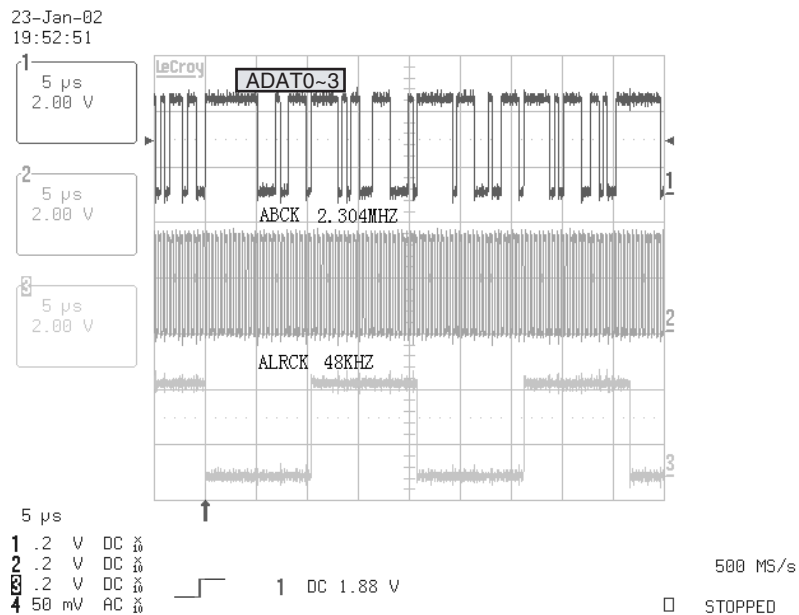

FIG 13-1

14. AUDIO OUTPUT FROM PWM IC

23-Jan-02
20:03:39

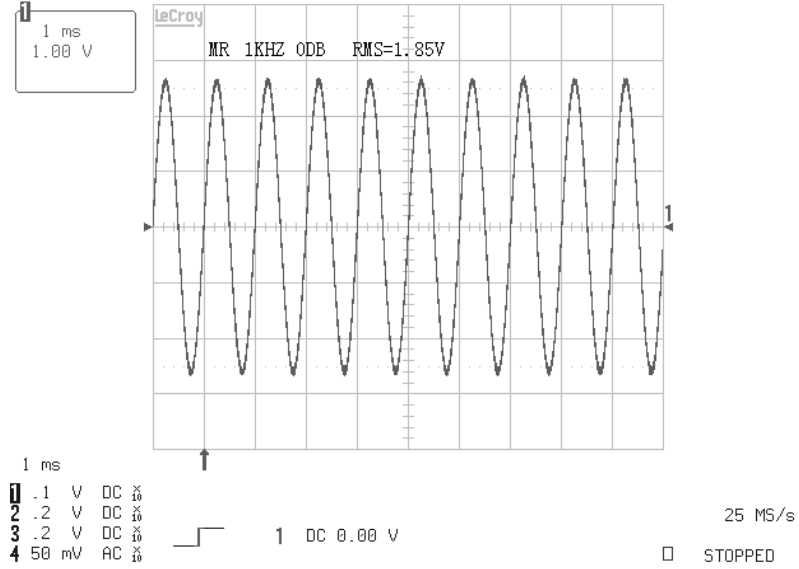
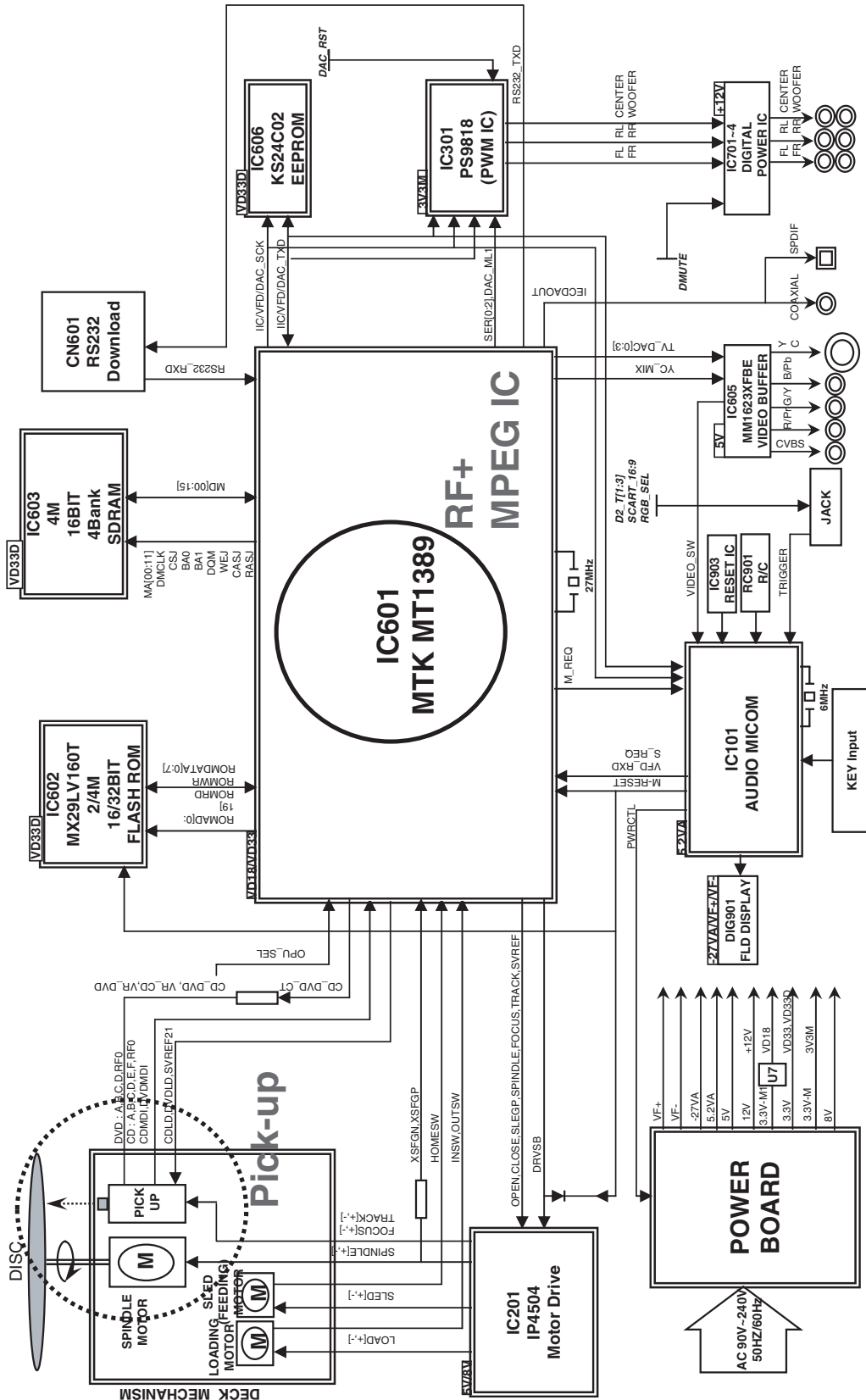

FIG 14-1

□ BLOCK DIAGRAM

1. Overall Block Diagram



2. SERVO Block Diagram

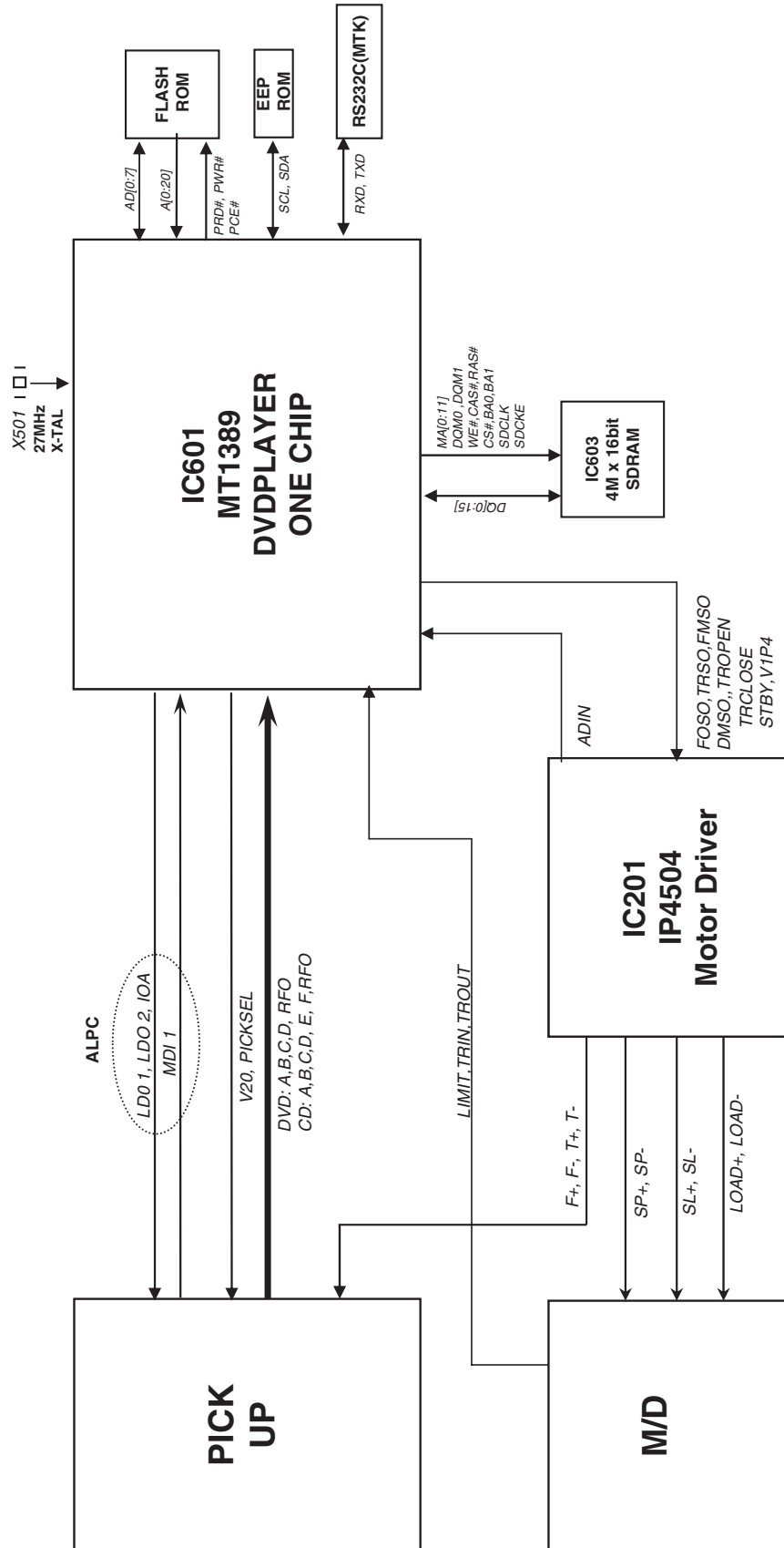

3. MPEG & MEMORY Block Diagram

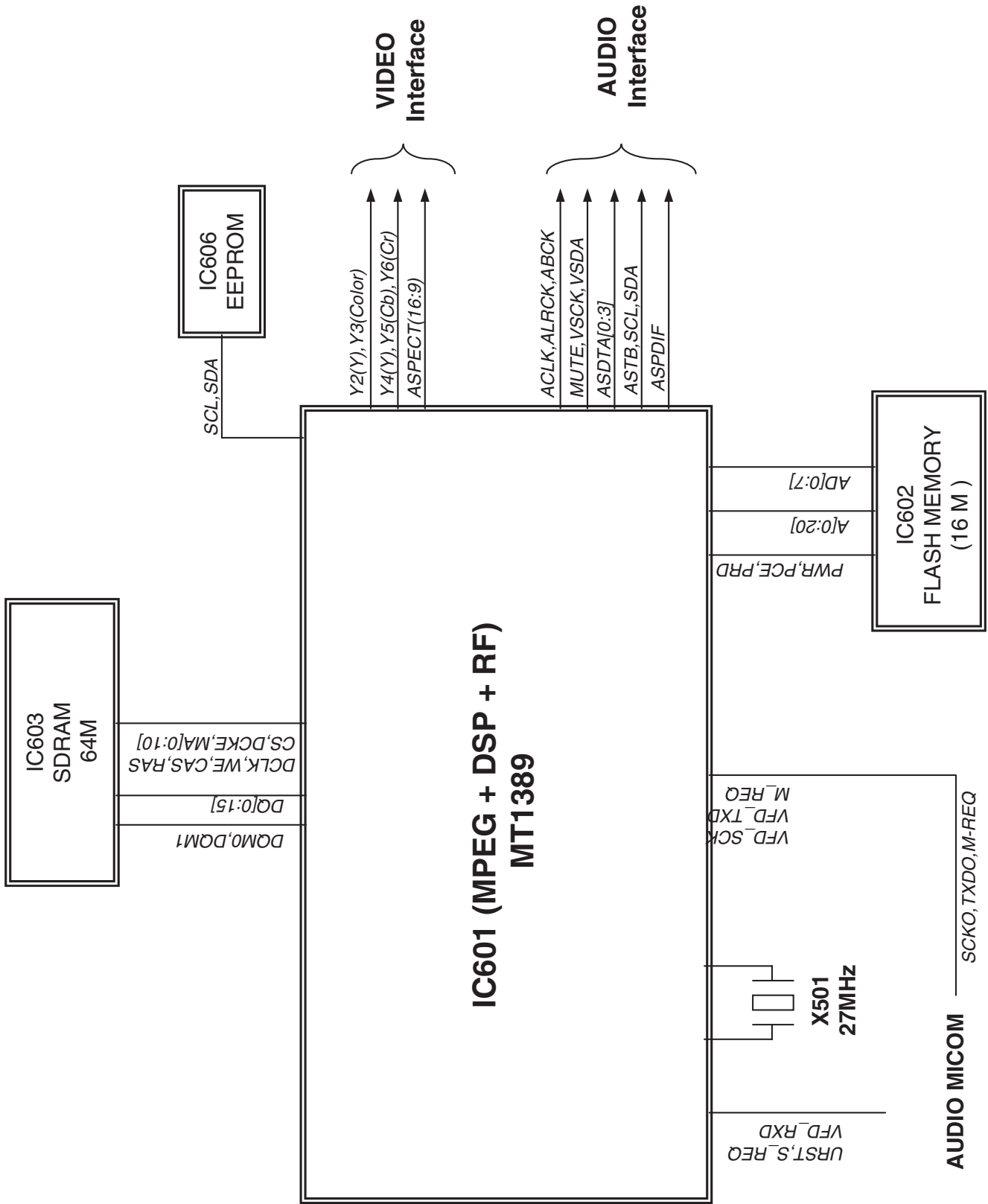

4. VIDEO & AUDIO Block Diagram

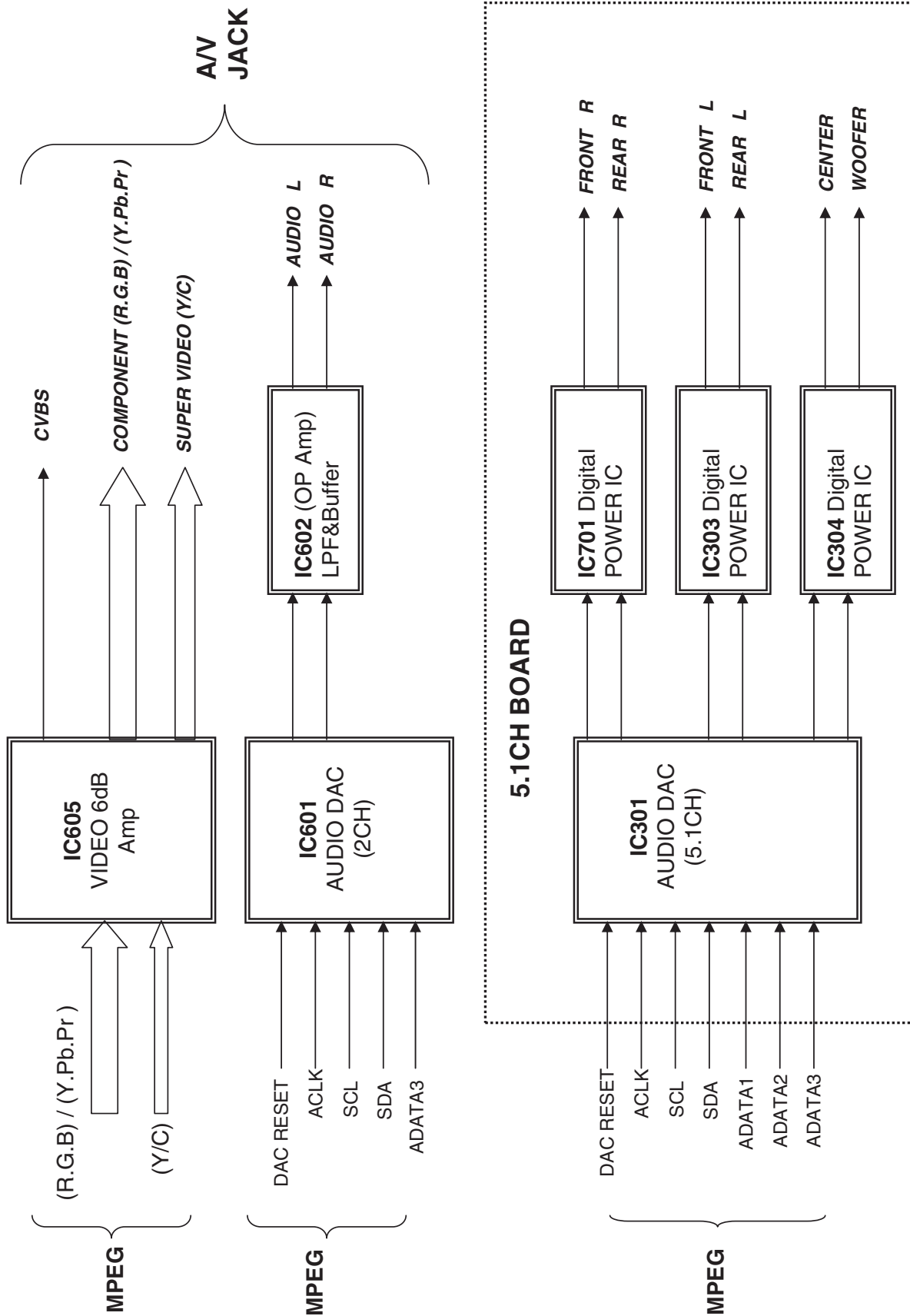

DVD PART SCHEMATIC DIAGRAMS

MPEG SCHEMATIC DIAGRAM

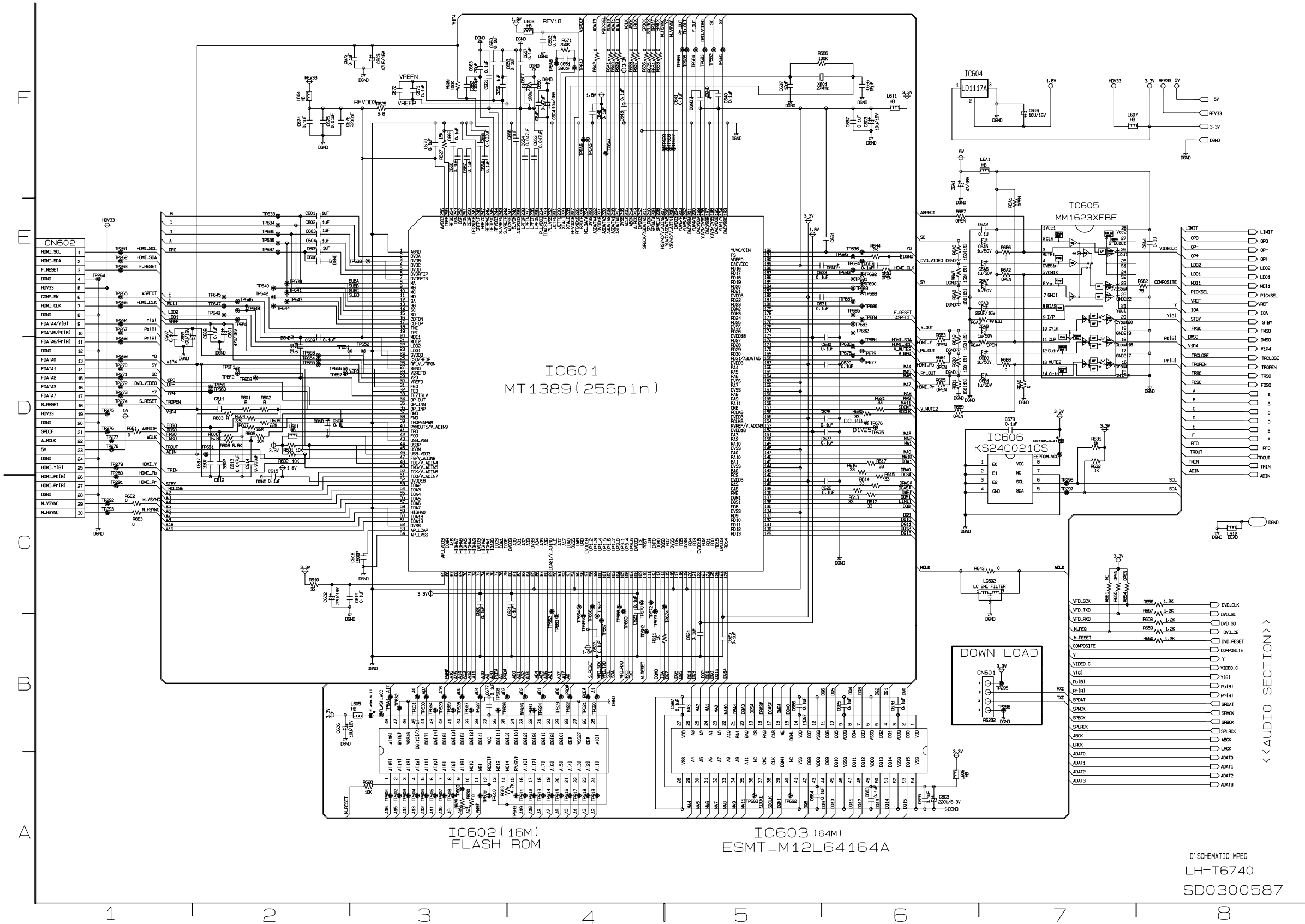

• SERVO SCHEMATIC DIAGRAM

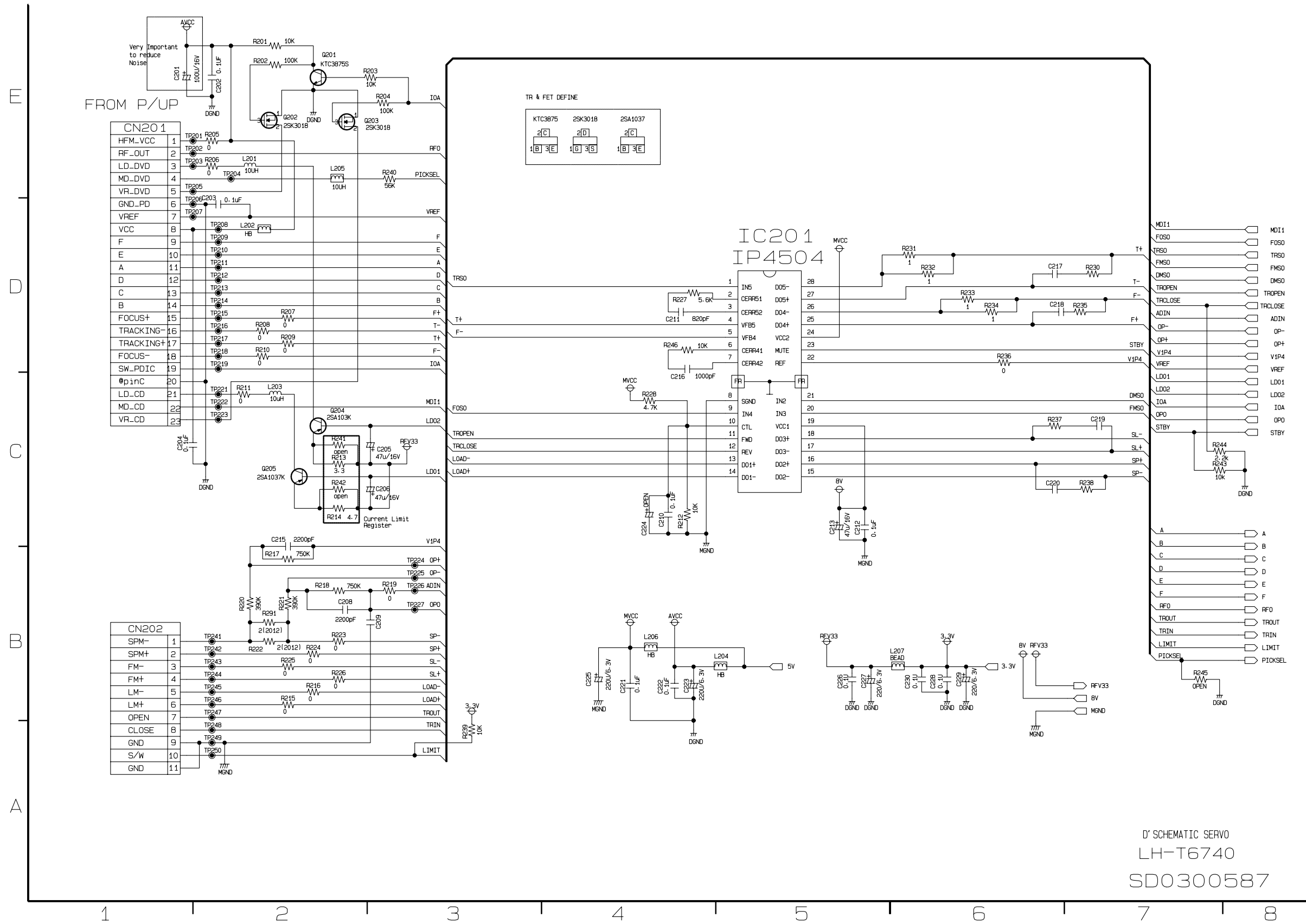

D' SCHEMATIC SERVO
LH-T6740
SD0300587

SECTION 4. EXPLODED VIEWS

• CABINET AND MAIN FRAME SECTION

NOTE) Refer to "SECTION 6 REPLACEMENT PARTS LIST" in order to look for the part number of each part.

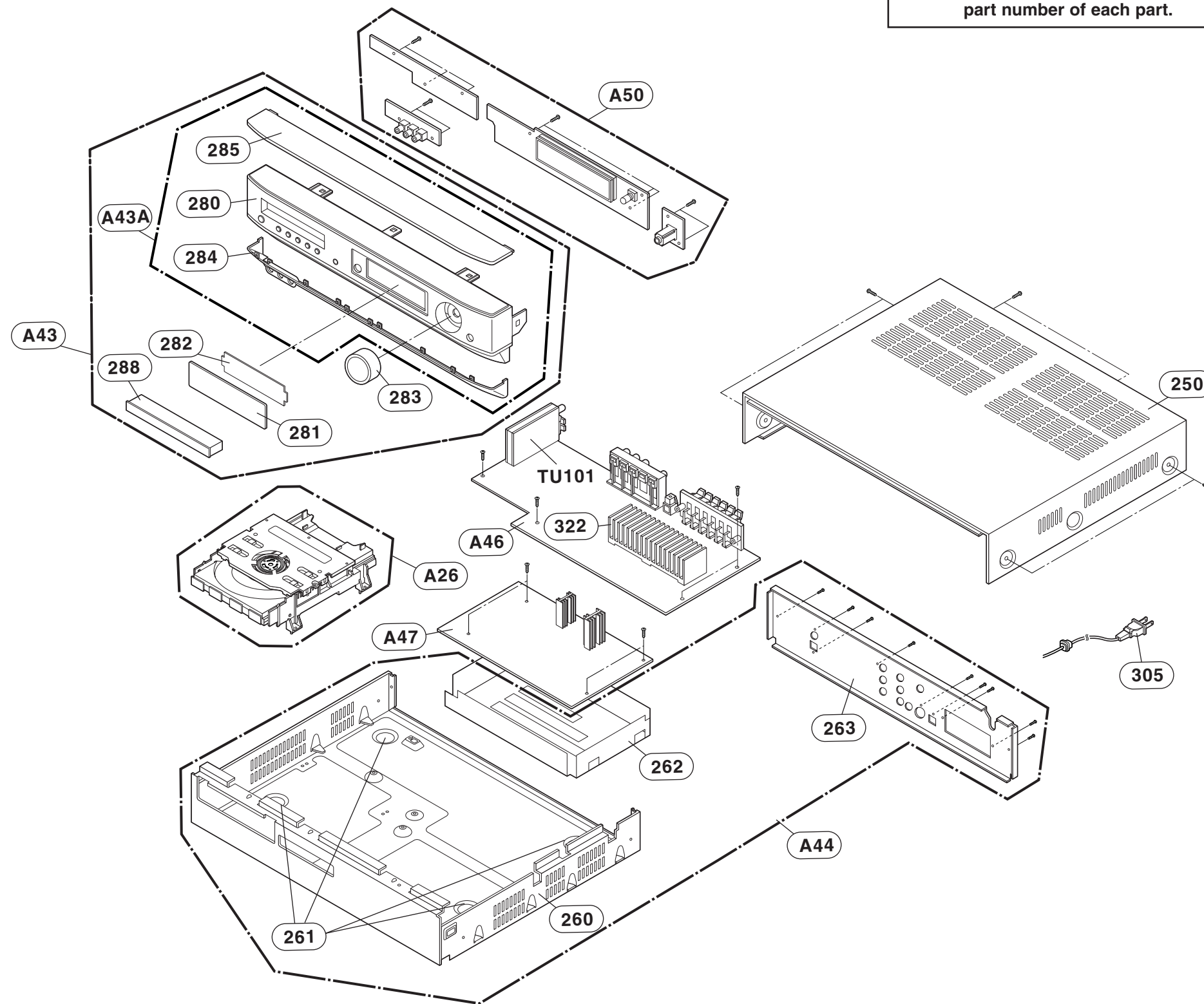

• DECK MECHANISM EXPLODED VIEW

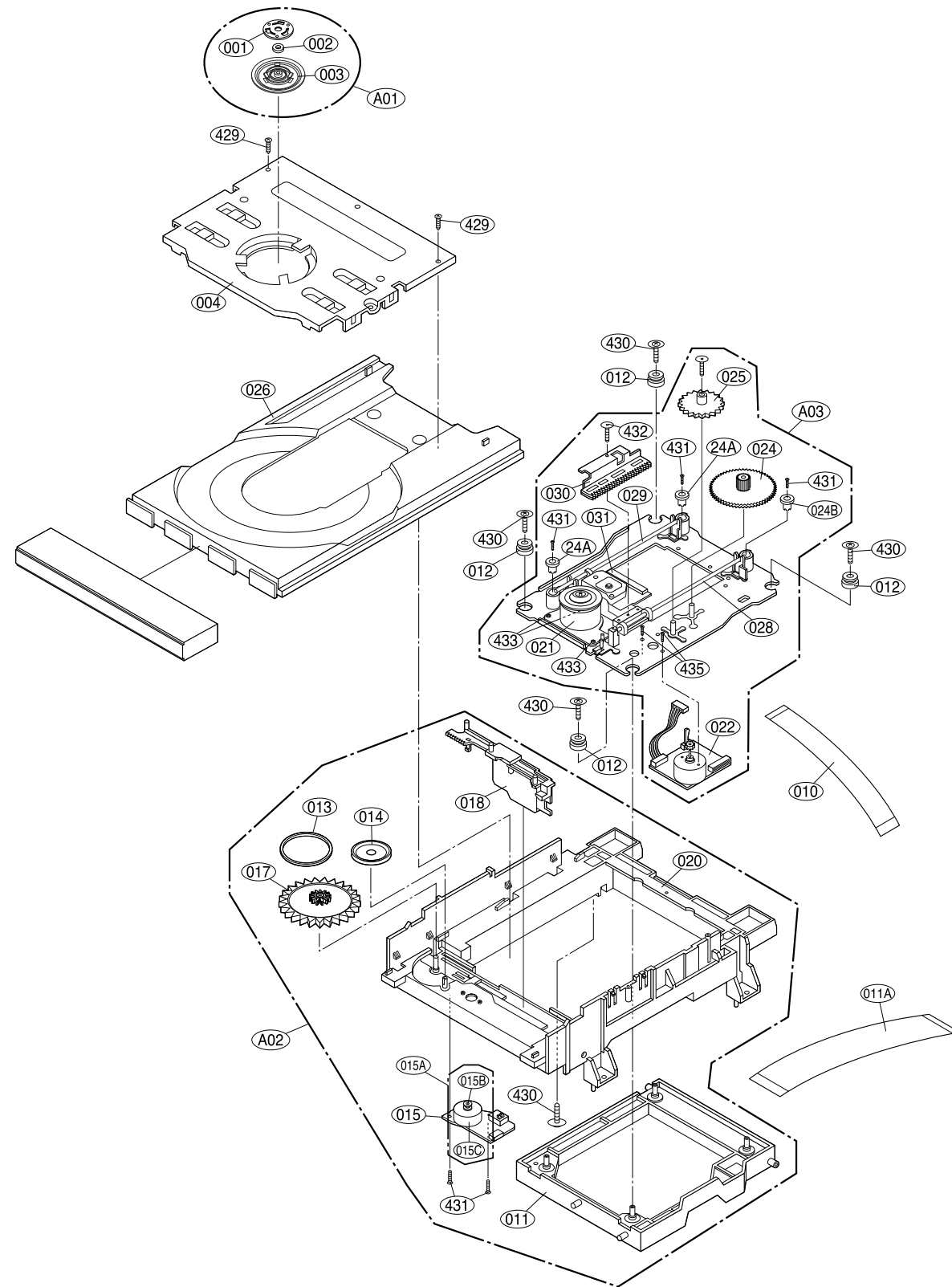

SECTION 5. SPEAKER PART

□ MODEL: LHS-T6749W

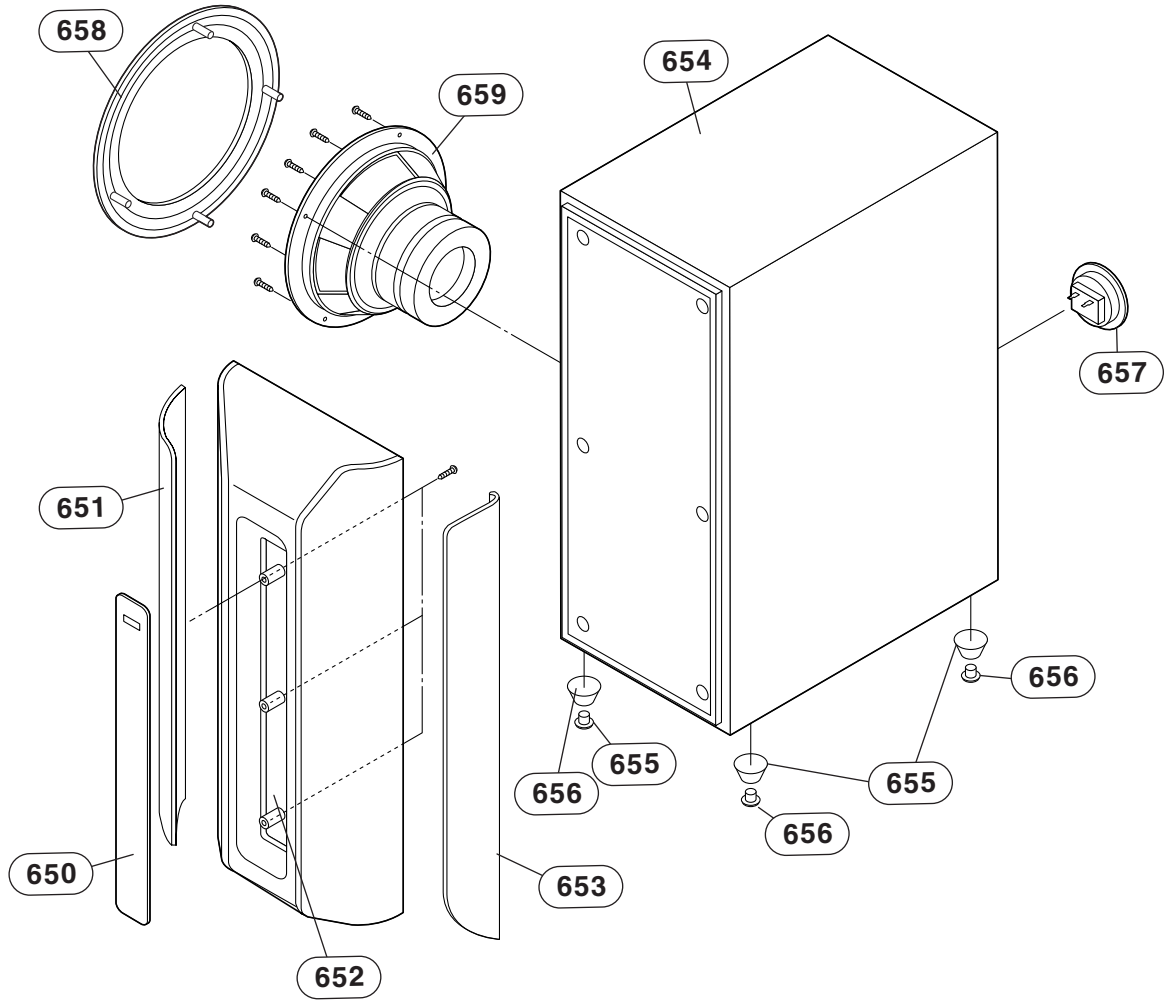

□ MODEL: LHS-T6749C

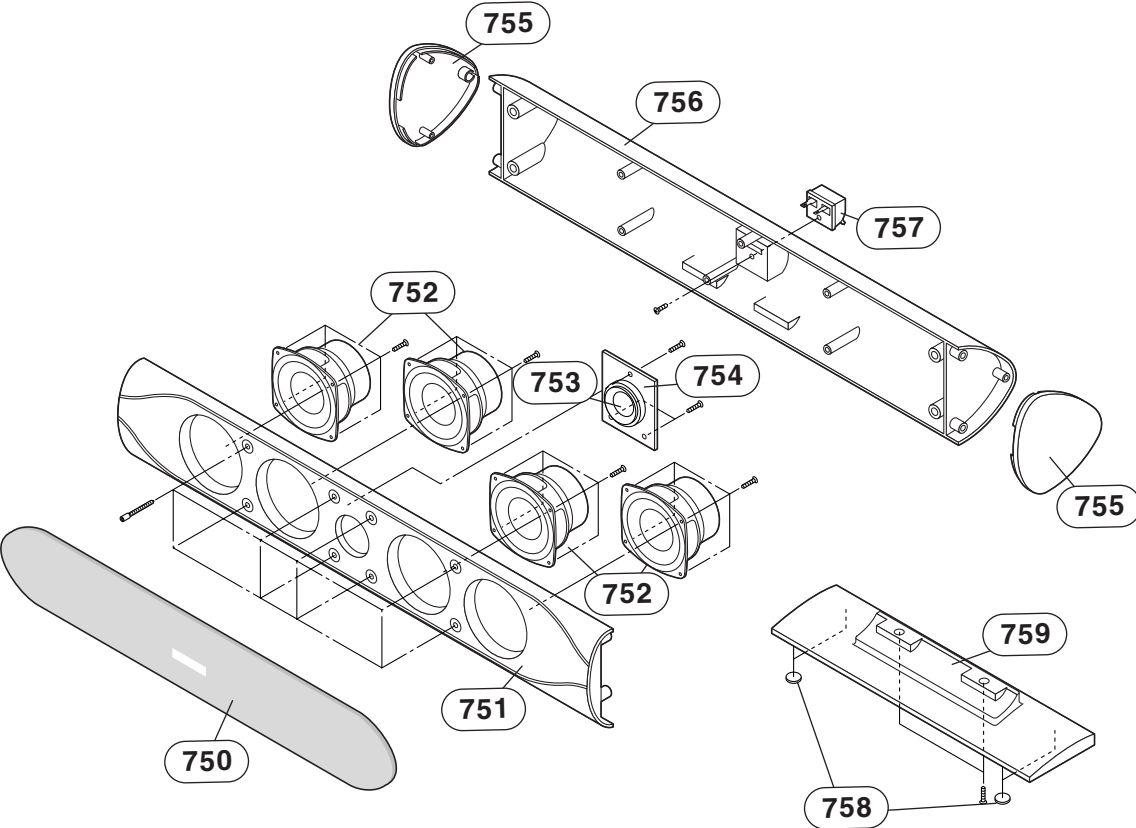

□ MODEL: LHS-T6749T

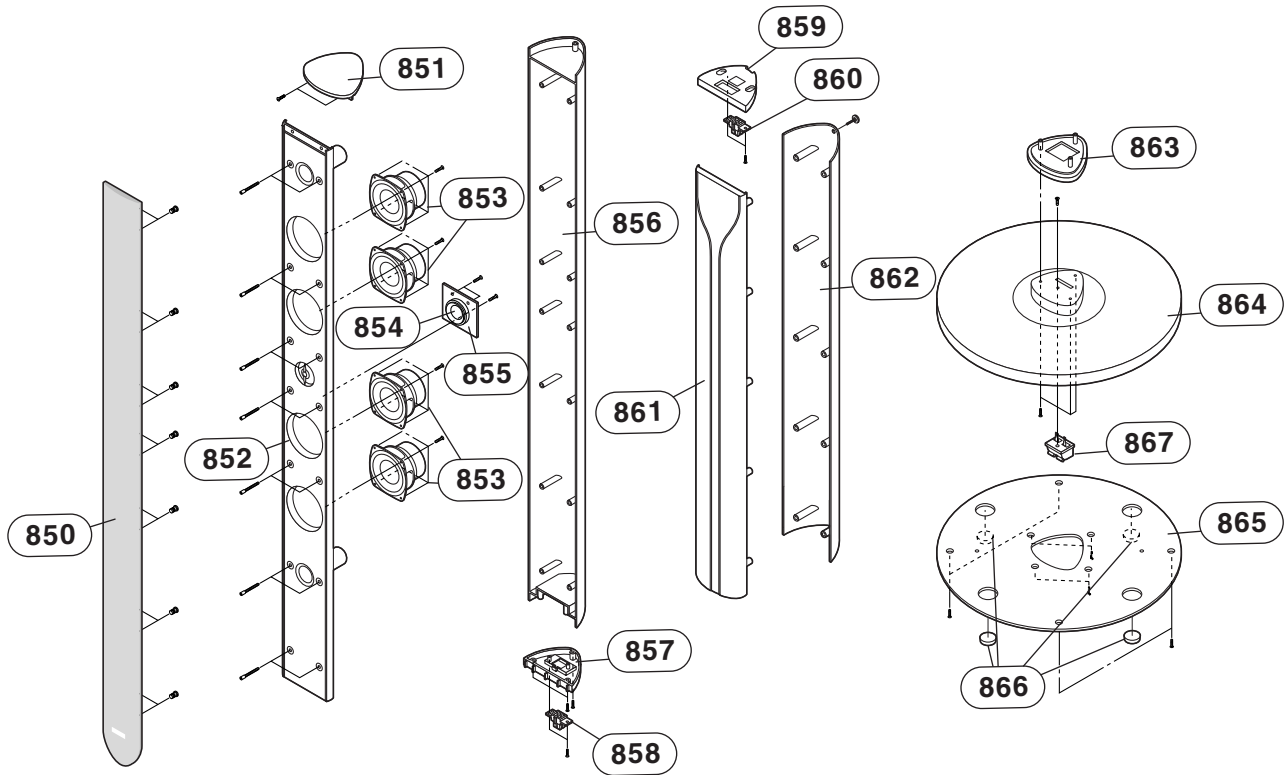

MEMO