

LH0022/LH0022C High Performance FET Op Amp

LH0042/LH0042C Low Cost FET Op Amp

LH0052/LH0052C Precision FET Op Amp

General Description

The LH0022/LH0042/LH0052 are a family of FET input operational amplifiers with very closely matched input characteristics, very high input impedance, and ultra-low input currents with no compromise in noise, common mode rejection ratio, open loop gain, or slew rate. The internally laser nulled LH0052 offers 500 microvolts maximum offset and $5 \mu\text{V}/^\circ\text{C}$ offset drift. Input offset current is less than 500 femtoamps at room temperature and 500 pA maximum at 125°C . The LH0022 and LH0042 are not internally nulled but offer comparable matching characteristics. All devices in the family are internally compensated and are free of latch-up and unusual oscillation problems. The devices may be offset nulled with a single 10k trimpot with negligible effect in CMRR.

The LH0022, LH0042 and LH0052 are specified for operation over the -55°C to $+125^\circ\text{C}$ military temperature range. The LH0022C, LH0042C and LH0052C are specified for operation over the -25°C to $+85^\circ\text{C}$ temperature range.

Features

- Low input offset current—500 femtoamps max. (LH0052)

- Low input offset drift— $5 \mu\text{V}/^\circ\text{C}$ max (LH0052)
- Low input offset voltage—100 microvolts—typ.
- High open loop gain—100 dB typ.
- Excellent slew rate— $3.0 \text{ V}/\mu\text{s}$ typ.
- Internal 6 dB/octave frequency compensation
- Pin compatible with standard IC op amps (TO-5 package)

The LH0022/LH0042/LH0052 family of IC op amps are intended to fulfill a wide variety of applications for process control, medical instrumentation, and other systems requiring very low input currents and tightly matched input offsets. The LH0052 is particularly suited for long term high accuracy integrators and high accuracy sample and hold buffer amplifiers. The LH0022 and LH0042 provide low cost high performance for such applications as electrometer and photocell amplification, pico-ammeters, and high input impedance buffers.

Special electrical parameter selection and custom built circuits are available on special request.

For additional application information and information on other National operational amplifiers, see *Available Linear Applications Literature*.

Schematic and Connection Diagrams

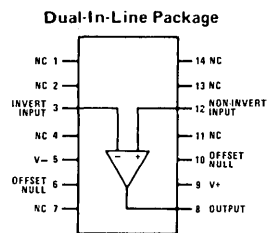
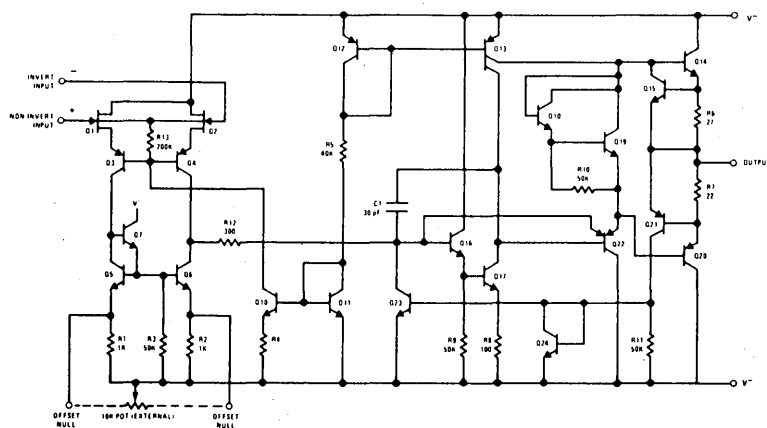

TOP VIEW
Order Number LH0022D,
LH0022CD, LH0042D, LH0042CD,
LH0052D or LH0052CD
See Package D14E

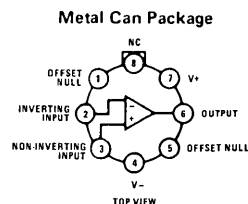

TOP VIEW
Order Number LH0022H, LH0022CH,
LH0042H, LH0042CH,
LH0052H or LH0052CH
See Package H08A

*Previously Called NH0022/NH0022C

Absolute Maximum Ratings

Supply Voltage	±22V
Power Dissipation (see graph)	500 mW
Input Voltage (Note 1)	±15V
Differential Input Voltage (Note 2)	±30V
Voltage Between Offset Null and V ⁻	±0.5V
Short Circuit Duration	Continuous
Operating Temperature Range	
LH0022, LH0042, LH0052	-55°C to +125°C
LH0022C, LH0042C, LH0052C	-25°C to +85°C
Storage Temperature Range	-65°C to +150°C
Lead Temperature (Soldering, 10 sec)	300°C

DC Electrical Characteristics for LH0022/LH0022C (Note 3)

PARAMETER	CONDITIONS	LIMITS						UNITS
		LH0022			LH0022C			
		MIN	TYP	MAX	MIN	TYP	MAX	
Input Offset Voltage	$R_S \leq 100 \text{ k}\Omega$; $T_A = 25^\circ\text{C}$, $V_S = \pm 15\text{V}$		2.0	4.0		3.5	6.0	mV
	$R_S \leq 100 \text{ k}\Omega$, $V_S = \pm 15\text{V}$			5.0			7.0	mV
Temperature Coefficient of Input Offset Voltage	$R_S \leq 100 \text{ k}\Omega$		5	10		5	15	$\mu\text{V}/^\circ\text{C}$
Offset Voltage Drift with Time	(Note 4)		3			4		$\mu\text{V}/\text{week}$
Input Offset Current	(Note 4)		0.2	2.0		1.0	5.0	pA
				2.0			0.5	nA
Temperature Coefficient of Input Offset Current			Doubles every 10°C			Doubles every 10°C		
Offset Current Drift with Time	(Note 4)		0.1			0.1		pA/week
Input Bias Current	(Note 4)		5	10		10	25	pA
				10			2.5	nA
Temperature Coefficient of Input Bias Current			Doubles every 10°C			Doubles every 10°C		
Differential Input Resistance			10^{12}			10^{12}		Ω
Common Mode Input Resistance			10^{12}			10^{12}		Ω
Input Capacitance			4.0			4.0		pF
Input Voltage Range	$V_S = \pm 15\text{V}$	±12	±13.5		±12	±13.5		V
Common Mode Rejection Ratio	$R_S \leq 10 \text{ k}\Omega$, $V_{IN} = \pm 10\text{V}$	80	90		70	90		dB
Supply Voltage Rejection Ratio	$R_S \leq 10 \text{ k}\Omega$, $\pm 5\text{V} \leq V_S \leq \pm 15\text{V}$	80	90		70	90		dB
Large Signal Voltage Gain	$R_L = 2 \text{ k}\Omega$, $V_{OUT} = \pm 10\text{V}$, $T_A = 25^\circ\text{C}$, $V_S = \pm 15\text{V}$	100	200		75	160		V/mV
	$R_L = 2 \text{ k}\Omega$, $V_{OUT} = \pm 10\text{V}$, $V_S = \pm 15\text{V}$		50		50			V/mV
Output Voltage Swing	$R_L = 1 \text{ k}\Omega$, $T_A = 25^\circ\text{C}$, $V_S = \pm 15\text{V}$	±10	±12.5		±10	±12		V
	$R_L = 2 \text{ k}\Omega$, $V_S = \pm 15\text{V}$	±10			±10			V
Output Current Swing	$V_{OUT} = \pm 10\text{V}$, $T_A = 25^\circ\text{C}$	±10	±15		±10	±15		mA
Output Resistance			75			75		Ω
Output Short Circuit Current			25			25		mA
Supply Current	$V_S = \pm 15\text{V}$		2.0	2.5		2.4	2.8	mA
Power Consumption	$V_S = \pm 15\text{V}$			75			85	mW

DC Electrical Characteristics for LH0042/LH0042C (Note 3)

Parameter	Conditions	Limits						Units
		LH0042			LH0042C			
		Min.	Typ.	Max.	Min.	Typ.	Max.	
Input Offset Voltage	$R_S \leq 100\text{ k}\Omega$	5.0		20		6.0	20	mV
Temperature Coefficient of Input Offset Voltage	$R_S \leq 100\text{ k}\Omega$		5.0			10		$\mu\text{V}/^\circ\text{C}$
Offset Voltage Drift with Time			7.0			10		$\mu\text{V}/\text{week}$
Input Offset Current	(Note 4)		1.0	5.0		2.0	10	pA
Temperature Coefficient of Input Offset Current		Doubles every 10°C			Doubles every 10°C			
Offset Current Drift with Time			0.1			0.1		pA/week
Input Bias Current	(Note 4)		10	25		15	50	pA
Temperature Coefficient of Input Bias Current		Doubles every 10°C			Doubles every 19°C			
Differential Input Resistance			10^{12}			10^{12}		Ω
Common Mode Input Resistance			10^{12}			10^{12}		Ω
Input Capacitance			4.0			4.0		pF
Input Voltage Range		± 12	± 13.5		± 12	± 13.5		V
Common Mode Rejection Ratio	$R_S \leq 10\text{ k}\Omega, V_{IN} = \pm 10\text{V}$	70	86		70	80		dB
Supply Voltage Rejection Ratio	$R_S \leq 10\text{ k}\Omega, \pm 5\text{V} \leq V_S \leq \pm 15\text{V}$	70	86		70	80		dB
Large Signal Voltage Gain	$R_S \leq 2\text{ k}\Omega, V_{OUT} = \pm 10\text{V}$	50	150		25	100		V/mV
Output Voltage Swing	$R_L = 1\text{ k}\Omega, T_A = 25^\circ\text{C}$	± 10	± 12.5		± 10	± 12		V
	$R_L = 2\text{ k}\Omega$	± 10			± 10			V
Output Current Swing	$V_{OUT} = \pm 10\text{V}$	± 10	± 15		± 10	± 15		mA
Output Resistance			75			75		Ω
Output Short Circuit Current			20			20		mA
Supply Current			2.5	3.5		2.8	4.0	mA
Power Consumption				105			120	mW

DC Electrical Characteristics For LH0052/LH0052C (Note 3)

Parameter	Conditions	Limits						Units
		LH0052			LH0052C			
		Min.	Typ.	Max.	Min.	Typ.	Max.	
Input Offset Voltage	$R_S < 100\text{ k}\Omega, V_S = +15\text{V}$ $T_A = 25^\circ\text{C}$		0.1	0.5		0.2	1.0	mV
Temperature Coefficient of Input Offset Voltage	$R_S < 100\text{ k}\Omega, V_S = \pm 15\text{V}$			1.0			1.5	$\mu\text{V}/^\circ\text{C}$
Offset Voltage Drift with Time			2.0			4.0		$\mu\text{V}/\text{week}$
Input Offset Current	(Note 4)		0.01	5.0		0.02	1.0	pA
Temperature Coefficient of Input Offset Current		Doubles every 10°C			Doubles every 10°C			
Offset Current Drift with Time			<0.1			<0.1		pA/week
Input Bias Current	(Note 4)		0.5	2.5		1.0	5.0	pA
Temperature Coefficient of Input Bias Current		Doubles every 10°C			Doubles every 10°C			
Differential Input Resistance			10^{12}			10^{12}		Ω
Common Mode Input Resistance			10^{12}			10^{12}		Ω
Input Capacitance			4.0			4.0		pF
Input Voltage Range	$V_S = \pm 15\text{V}$	± 12	± 13.5		± 12	± 13.5		V
Common Mode Rejection Ratio	$R_S \leq 10\text{ k}\Omega, V_{IN} = \pm 10\text{V}$	74	90		70	90		dB
Supply Voltage Rejection Ratio	$R_S \leq 10\text{ k}\Omega, \pm 5\text{V} \leq V_S \leq \pm 15\text{V}$	74	90		70	90		dB
Large Signal Voltage Gain	$R_L = 2\text{ k}\Omega, V_{OUT} = \pm 10\text{V}$ $V_S = \pm 15\text{V}, T_A = 25^\circ\text{C}$	100	200		75	160		V/mV
	$R_L = 2\text{ k}\Omega, V_{OUT} = \pm 10\text{V}$ $V_S = \pm 15\text{V}$	50			50			V/mV
Output Voltage Swing	$R_L = 1\text{ k}\Omega, T_A = 25^\circ\text{C}$ $V_S = \pm 15\text{V}$	± 10	± 12.5		± 10	± 12		V
	$R_L = 2\text{ k}\Omega, V_S = \pm 15\text{V}$	± 10			± 10			V
Output Current Swing	$V_{OUT} = \pm 10\text{V}, t_A = 25^\circ\text{C}$	± 10	± 15		± 10	± 15		mA
Output Resistance			75			75		Ω
Output Short Circuit Current			25			25		mA
Supply Current	$V_S = \pm 15\text{V}$		3.0	3.5		3.0	3.8	mA
Power Consumption	$V_S = \pm 15\text{V}$			105			114	mW

1

LH0022/LH0022C, LH0042/LH0042C, LH0052/LH0052C

AC Electrical Characteristics For all amplifiers ($T_A = 25^\circ\text{C}$, $V_S = \pm 15\text{V}$)

PARAMETER	CONDITIONS	LIMITS						UNITS
		LH0022/42/52			LH0022C/42C/52C			
		MIN	TYP	MAX	MIN	TYP	MAX	
Slew Rate	Voltage Follower	1.5	3.0		1.0	3.0		V/ μs
Large Signal Bandwidth	Voltage Follower		40			40		kHz
Small Signal Bandwidth			1.0			1.0		MHz
Rise Time			0.3	1.5		0.3		μs
Overshoot			10	30		15	40	%
Settling Time (0.1%)	$\Delta V_{IN} = 10\text{V}$		4.5			4.5		μs
Overload Recovery			4.0			4.0		μs
Input Noise Voltage	$R_S = 10\text{ k}\Omega$, $f_o = 10\text{ Hz}$		150			150		$\text{nV}/\sqrt{\text{Hz}}$
Input Noise Voltage	$R_S = 10\text{ k}\Omega$, $f_o = 100\text{ Hz}$		55			55		$\text{nV}/\sqrt{\text{Hz}}$
Input Noise Voltage	$R_S = 10\text{ k}\Omega$, $f_o = 1\text{ kHz}$		35			35		$\text{nV}/\sqrt{\text{Hz}}$
Input Noise Voltage	$R_S = 10\text{ k}\Omega$, $f_o = 10\text{ kHz}$		30			30		$\text{nV}/\sqrt{\text{Hz}}$
Input Noise Voltage	$\text{BW} = 10\text{ Hz to } 10\text{ kHz}$, $R_S = 10\text{ k}\Omega$		12			12		μVrms
Input Noise Current	$\text{BW} = 10\text{ Hz to } 10\text{ kHz}$		<.1			<.1		pArms

Note 1: For supply voltages less than $\pm 15\text{V}$, the absolute maximum input voltage is equal to the supply voltage.
Note 2: Rating applies for minimum source resistance of $10\text{ k}\Omega$, for source resistances less than $10\text{ k}\Omega$, maximum differential input voltage is $\pm 5\text{V}$.
Note 3: Unless otherwise specified, these specifications apply for $-15\text{V} \leq V_S \leq \pm 20\text{V}$ and $-55^\circ\text{C} \leq T_A \leq \pm 125^\circ\text{C}$ for the LH0022 and LH0052 and $-25^\circ\text{C} \leq T_A \leq +85^\circ\text{C}$ for the LH0022C and LH0052C. Typical values are given for $T_A = 25^\circ\text{C}$.
Note 4: Input currents are a strong function of temperature. Due to high speed testing they are specified at a junction temperature $T_J = 25^\circ\text{C}$, self heating will cause an increase in current in manual tests.

Auxiliary Circuits (Shown for TO-5 pin out)

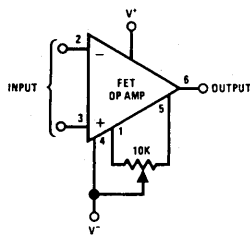

Offset Null

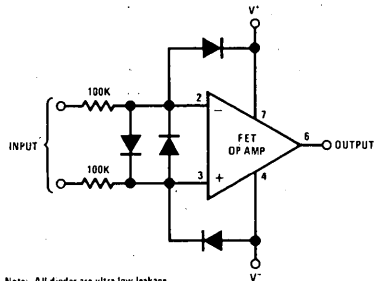

Note: All diodes are ultra low leakage

Protecting Inputs From $\pm 150\text{V}$ Transients

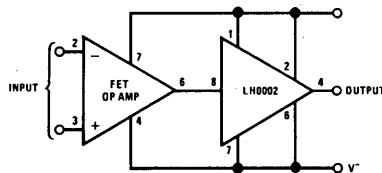

Boosting Output Drive to $\pm 100\text{ mA}$

Typical Applications

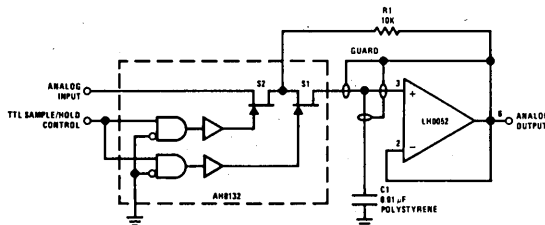

Low Drift Sample and Hold

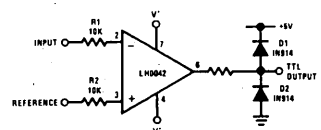

Precision Voltage Comparator

Typical Applications (Cont'd)

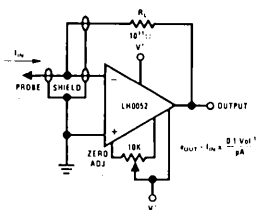

Picoamp Amplifier for pH Meters and Radiation Detectors

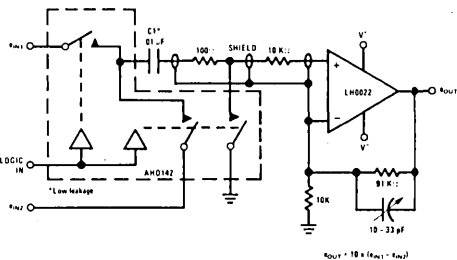

Precision Subtractor for Automatic Test Gear

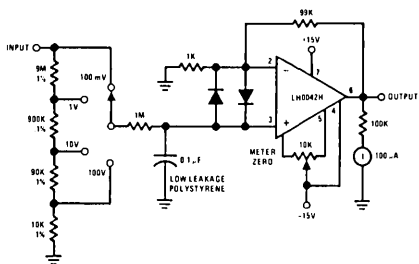

Sensitive Low Cost "VTVM"

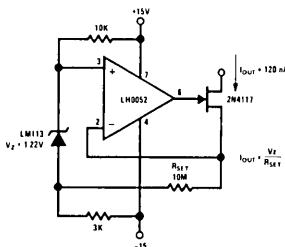

Ultra Low Level Current Source

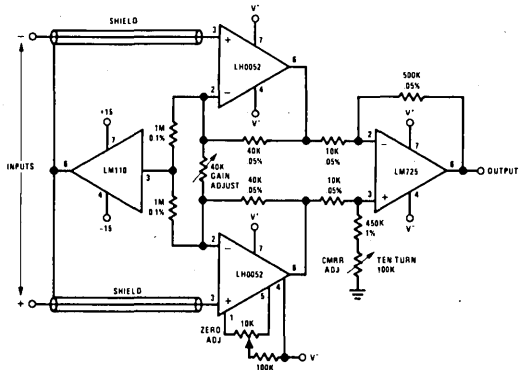

True Instrumentation Amplifier

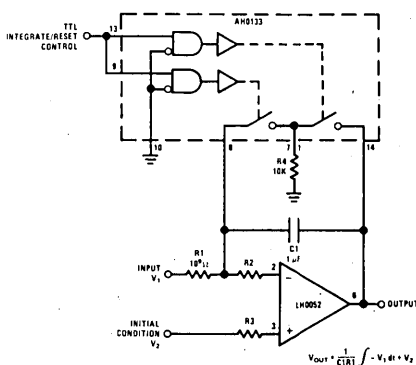

Precision Integrator

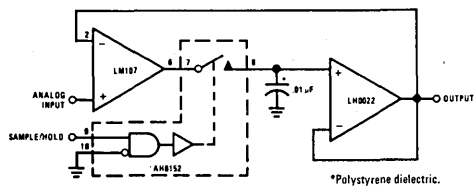

Precision Sample and Hold

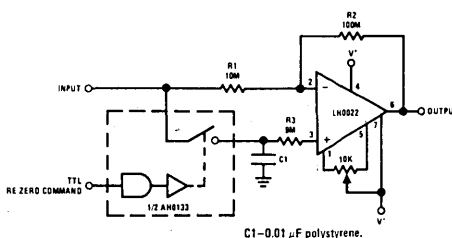

Re-Zeroing Amplifier

1

LH0022/LH0022C, LH0042/LH0042C, LH0052/LH0052C

Typical Performance Characteristics

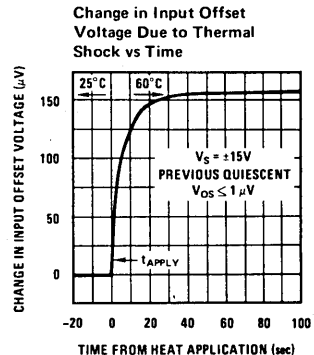
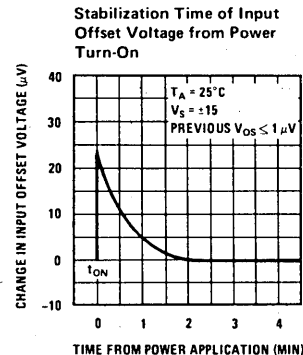
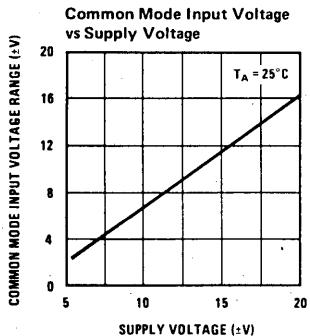
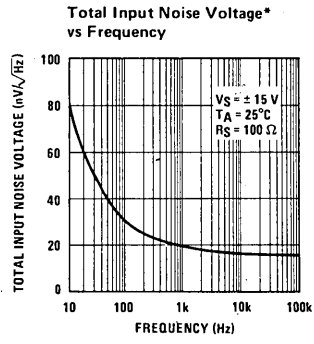
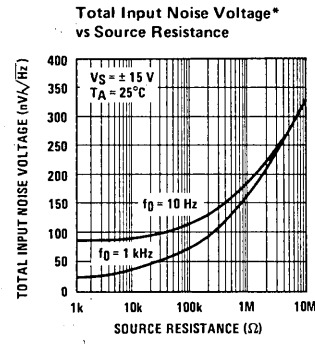
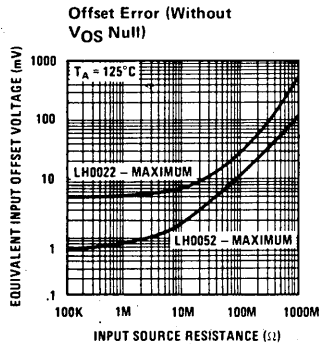
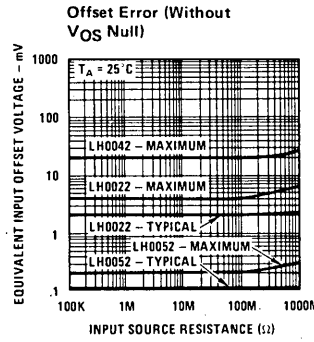
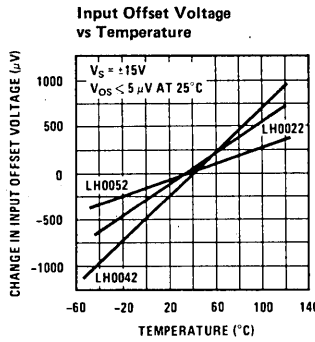
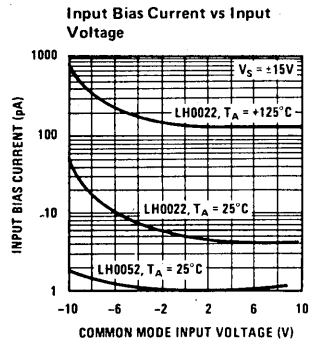
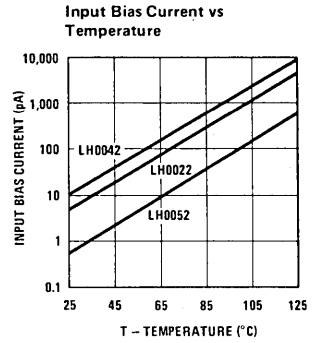
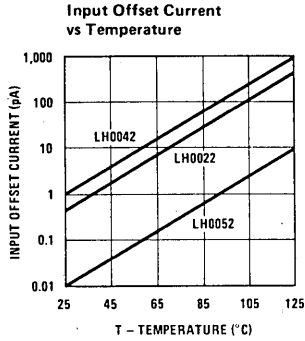
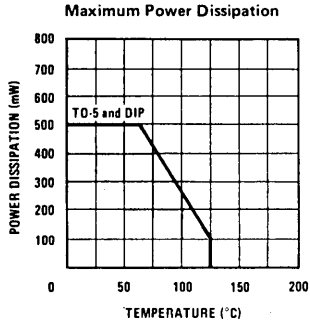

*Noise Voltage Includes Contribution from Source Resistance

Typical Performance Characteristics (Cont'd)

1

LH0022/LH0022C, LH0042/LH0042C, LH0052/LH0052C

Supply Voltage vs Supply Current

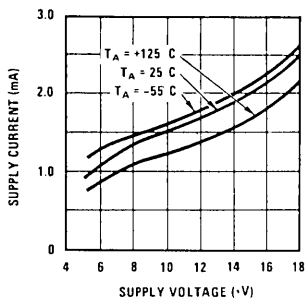

Voltage Gain

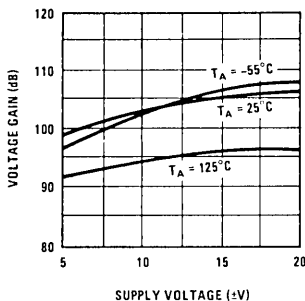

Output Swing vs Supply Voltage

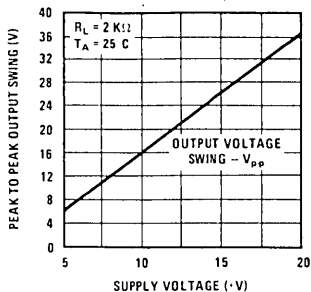

Output Voltage Swing vs Load Resistance

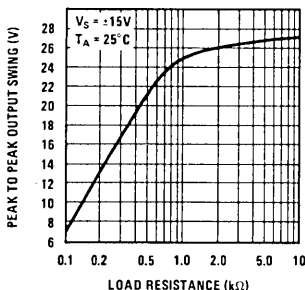

Current Limiting

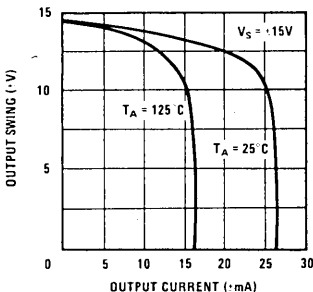

Output Voltage Swing vs Frequency

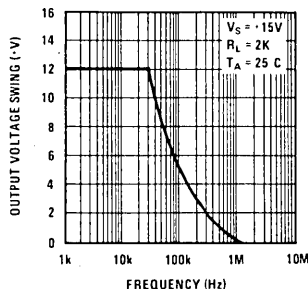

Voltage Follower Large Signal Response

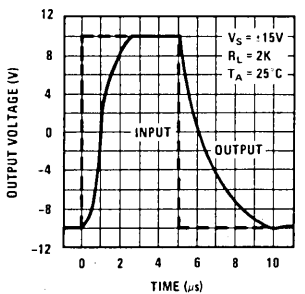

Transient Response

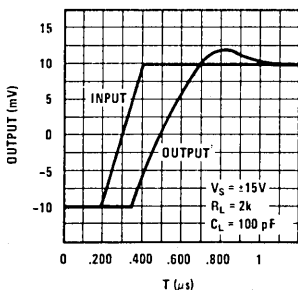

Frequency Characteristics vs Ambient Temperature

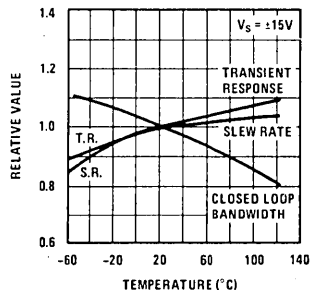

Frequency Characteristics vs Supply Voltage

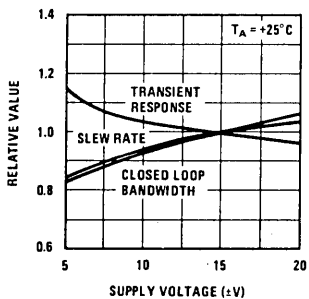

Output Resistance vs Frequency

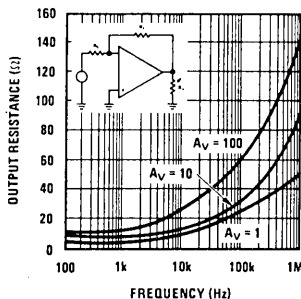

Open Loop Transfer Characteristics vs Frequency

