



# LH1525AT/AAB/AABTR

## 1 Form A Solid-State Relays

### FEATURES

- Extremely Low Operating Current
- High-speed Operation
- 5300 V<sub>RMS</sub> I/O Isolation
- Current-limit Protection
- High Surge Capability
- Linear, ac/dc Operation
- dc-only Option
- Clean, Bounce-free Switching
- Low Power Consumption
- High-reliability Monolithic Receptor
- Surface-mountable
- Flammability; UL94,VØ

### AGENCY APPROVALS

- UL – File No. E52744
- BSI/BABT Cert. No. 7980
- CSA – Certification 093751
- FIMKO Approval

### APPLICATIONS

- General Telecom Switching
  - Telephone Line Interface
  - On/off Hook
  - Ring Relay
  - Break Switch
  - Ground Start
- Battery-powered Switch Applications
- Industrial Controls
  - Microprocessor Control of Solenoids, Lights, Motors, Heaters, etc.
- Programmable Controllers
- Instrumentation
- See Application Note 56

### DESCRIPTION

The LH1525 relay as SPST normally open switches (1 Form A) that can replace electromechanical relays in many applications. The relay require a minimal amount of LED drive current to operate, making it ideal for battery-powered and power consumption sensitive applications. The relay is constructed using a GaAIAs LED for actuation control and an integrated monolithic die for the switch output. The die, fabricated in a high-voltage dielectrically isolated technology, comprised of a photo-diode array, switch-control circuitry, and MOSFET switches. In addition, the relay employs current-limiting circuitry, enabling it to pass FCC 68.302 and other regulatory surge requirements when overvoltage protection is provided. The relay can be configured for ac/dc or dc-

Package Dimensions in Inches (mm)

#### DIP

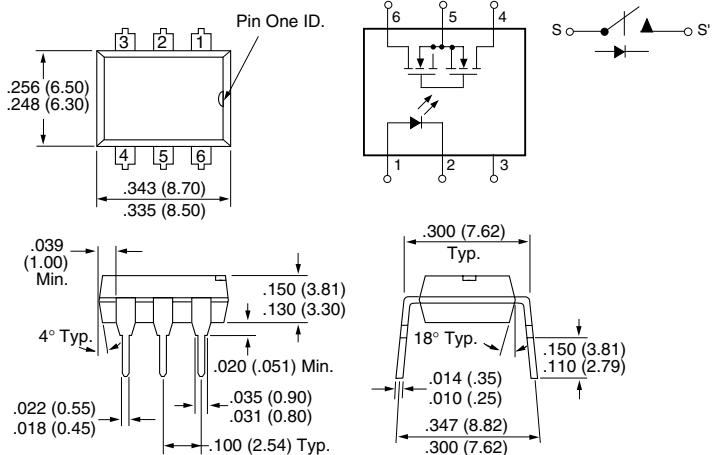

#### SMD

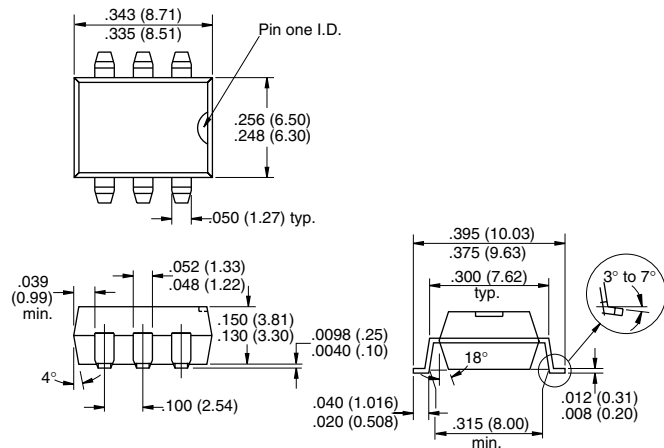

only operation.

### Part Identification

Part Number	Description
LH1525AT	6-pin DIP, Tubes
LH1525AAB	6-pin SMD, Tubes
LH1525AABTR	6-pin SMD, Tape and Reel

## Recommended Operating Conditions

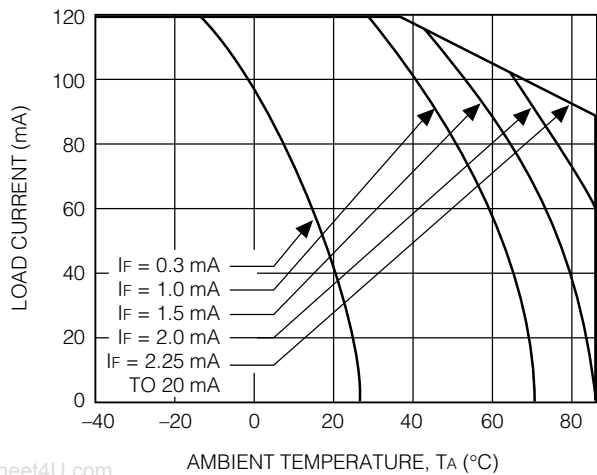

## Absolute Maximum Ratings, $T_A=25^\circ\text{C}$ (except where noted)

Stresses in excess of the absolute Maximum Ratings can cause permanent damage to the device. These are absolute stress ratings only. Functional operation of the device is not implied at these or any other conditions in excess of those given in the operational sections of this document. Exposure to absolute Maximum Ratings for extended periods of time can adversely affect reliability.

Ambient Operating Temperature Range,  $T_A$  .....  $-40^\circ$  to  $+85^\circ\text{C}$   
 Storage Temperature Range,  $T_{\text{stg}}$  .....  $-40^\circ$  to  $+150^\circ\text{C}$   
 Pin Soldering Temperature,  $t=10$  s max,  $T_S$  .....  $260^\circ\text{C}$   
 Input/Output Isolation Voltage,  $t=1.0$  s,  $V_{\text{ISO}}$  .....  $5300 V_{\text{RMS}}$

### LED Input Ratings:

Continuous Forward Current,  $I_F$  .....  $50$  mA  
 Reverse Voltage,  $V_R$  .....  $8.0$  V

### Output Operation (each channel)

dc or Peak ac Load Voltage,  $I_L \leq 50 \mu\text{A}$ ,  $V_L$  .....  $400$  V

Continuous dc Load Current,  $I_L$

Bidirectional Operation

Pin 4 to 6 .....  $125$  mA

Unidirectional Operation

Pins 4, 6 (+) to Pin 5 (-) .....  $250$  mA

Power Dissipation,  $P_{\text{DISS}}$  .....  $550$  mW

## Electrical Characteristics, $T_A=25^\circ\text{C}$

Minimum and maximum values are testing requirements. Typical values are characteristics of the device and are the result of engineering evaluations. Typical values are for information purposes only and are not part of the testing requirements.

Parameter	Symbol	Min.	Typ.	Max.	Unit	Test Condition
<b>Input</b>						
LED Forward Current for Switch Turn-on	$I_{\text{Fon}}$	—	0.33	0.5	mA	$I_L=100$ mA, $t=10$ ms
LED Forward Current for Switch Turn-off	$I_{\text{Foff}}$	0.01	0.23	—	mA	$V_L=\pm 350$ V, $t=100$ ms
LED Forward Voltage	$V_F$	0.80	1.16	1.40	V	$I_F=1.5$ mA
<b>Output</b>						
ON-resistance: ac/dc, each pole dc Pins 4, 6 (+) to 5 (-)	$R_{\text{ON}}$	17 4.25	26 7.0	36 8.25	$\Omega$ $\Omega$	$I_F=1.5$ mA, $I_L=\pm 50$ mA $I_F=1.5$ mA, $I_L=100$ mA
OFF-resistance	$R_{\text{OFF}}$	—	2000	—	G $\Omega$	$I_F=0$ mA, $V_L=\pm 100$ V
Current Limit	$I_{\text{LMT}}$	170	185	270	mA	$I_F=1.5$ mA, $t=5.0$ ms $V_L=7.0$ V
Output Off-state Leakage Current	$I_O$	— —	0.67 0.096	200 1.0	nA $\mu\text{A}$	$I_F=0$ mA, $V_L=\pm 100$ V $I_F=0$ mA, $V_L=\pm 400$ V
Output Capacitance	$C_O$	— —	22 6.42	— —	pF pF	$I_F=0$ mA, $V_L=1.0$ V $I_F=0$ mA, $V_L=50$ V
Switch Offset	$V_{\text{OS}}$	—	0.2	—	$\mu\text{V}$	$I_F=5.0$ mA
<b>Transfer</b>						
Input/Output Capacitance	$C_{\text{ISO}}$	—	0.75	—	pF	$V_{\text{ISO}}=1.0$ V
Turn-on Time	$t_{\text{on}}$	— —	1.25 0.22	— 1.0	ms ms	$I_F=1.5$ mA, $I_L=50$ mA $I_F=5.0$ mA, $I_L=50$ mA
Turn-off Time	$t_{\text{off}}$	— —	0.6 0.63	— 0.9	ms ms	$I_F=1.5$ mA, $I_L=50$ mA $I_F=5.0$ mA, $I_L=50$ mA

## Typical Performance Characteristics

**Figure 1. LED Voltage vs. Temperature**

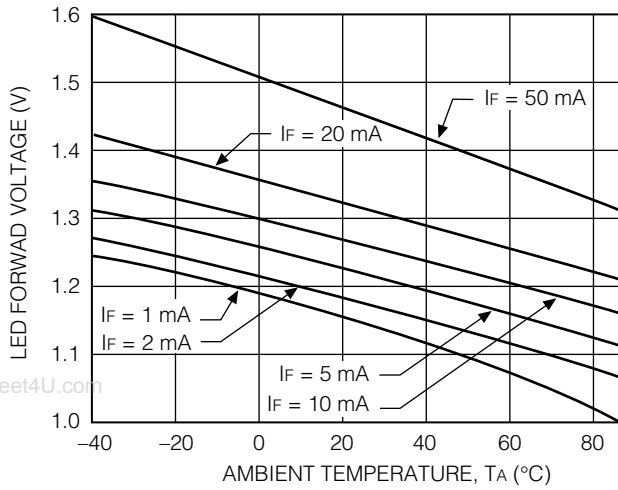

**Figure 4. LED Current for Switch Turn-on/off vs. Temperature**

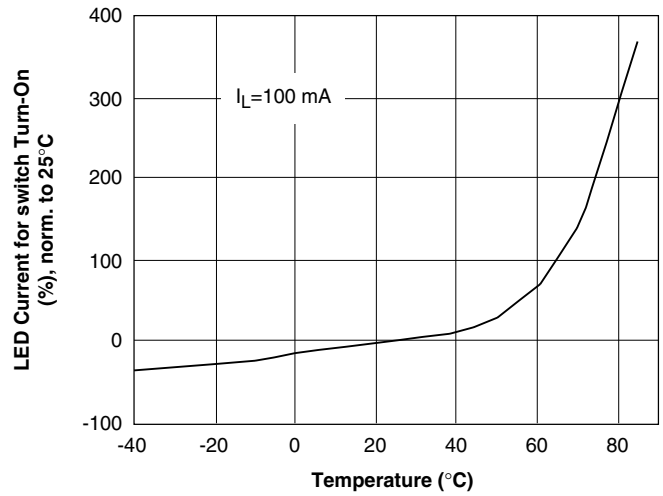

**Figure 2. LED Forward Current vs. LED Forward Voltage**

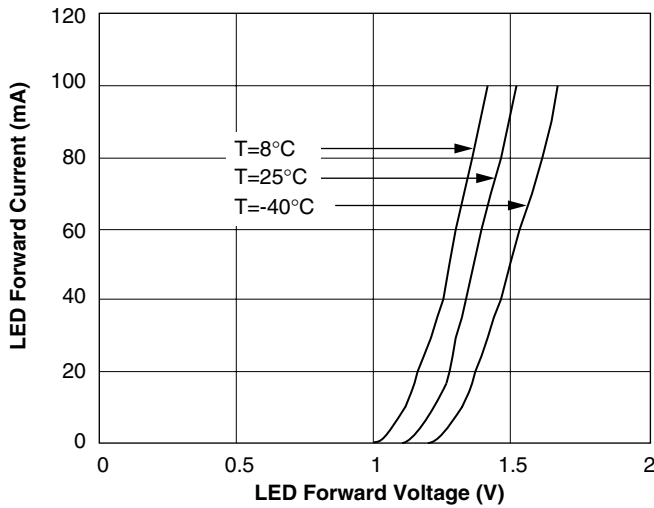

**Figure 5. ON-Resistance vs. Temperature**

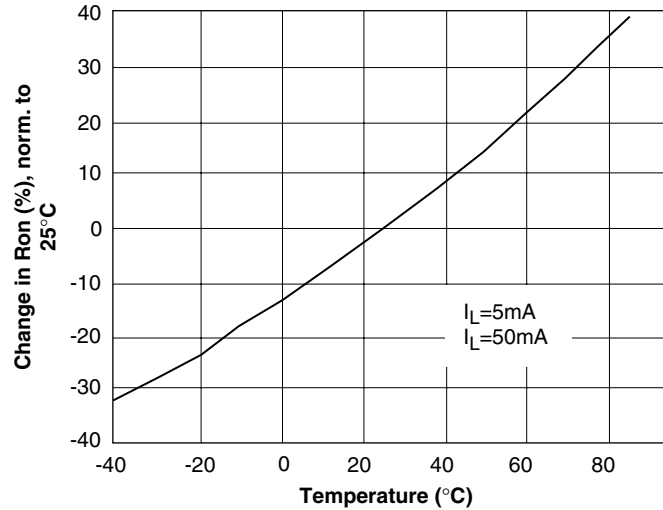

**Figure 3. LED Reverse Current vs. LED Reverse Voltage**

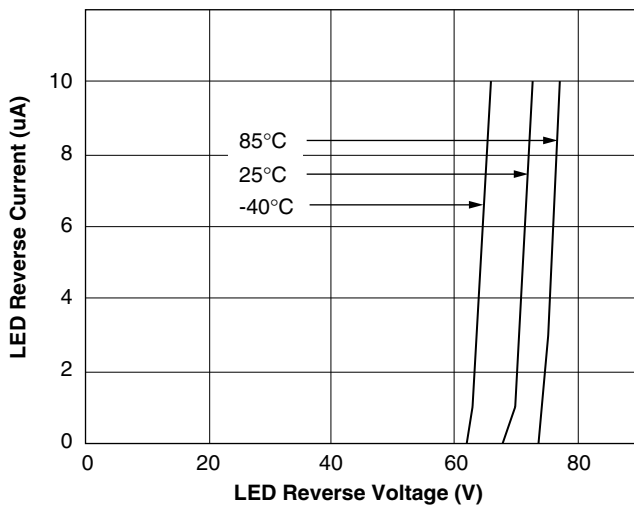

**Figure 6. LED Dropout Voltage vs. Temperature**

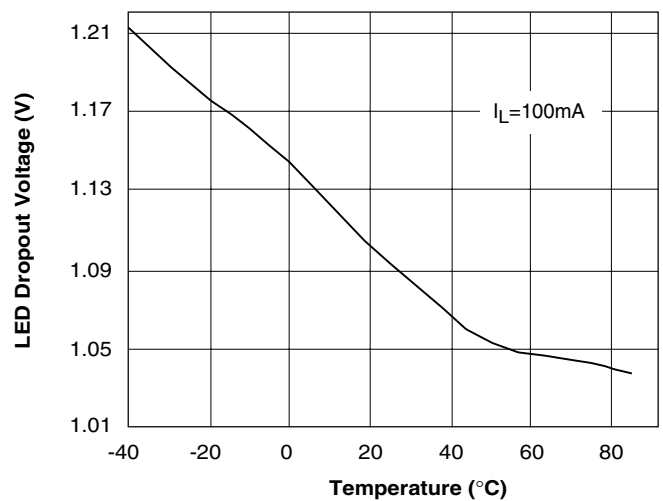

**Figure 7. Load Current vs. Load Voltage**

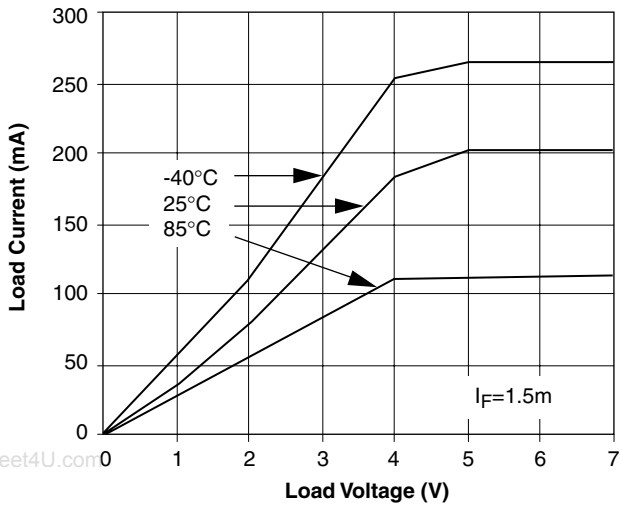

**Figure 10. Switch Capacitance vs. Applied Voltage**

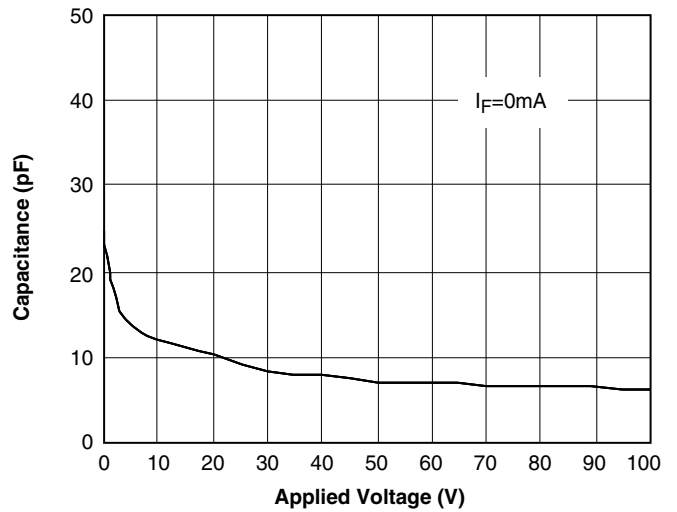

**Figure 8. Current Limit vs. Temperature**

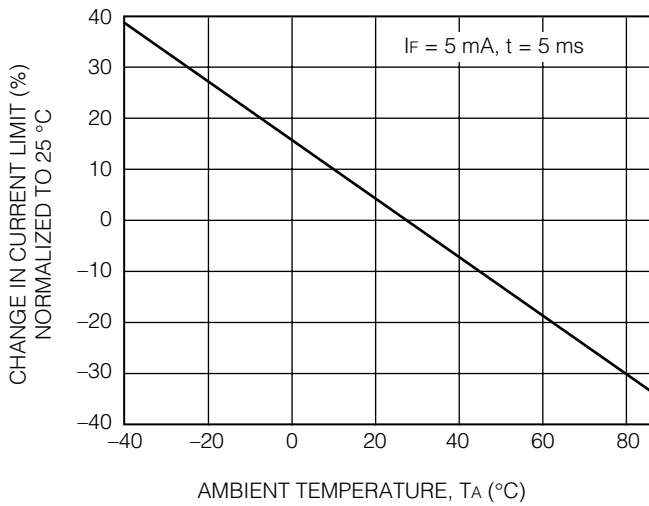

**Figure 11. Output Isolation**

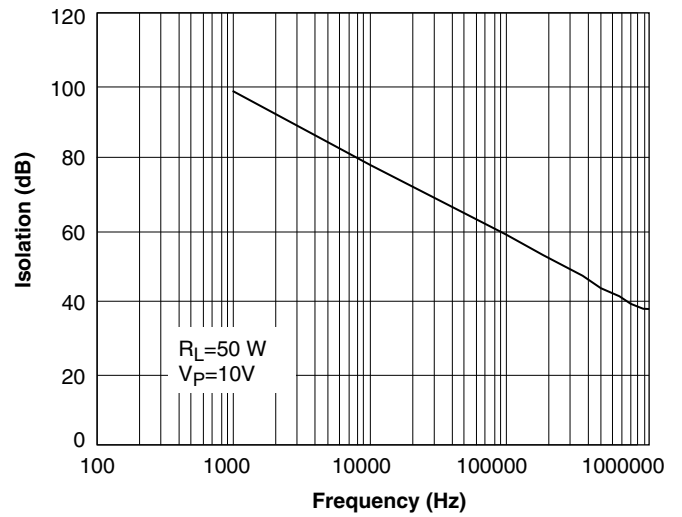

**Figure 9. Variation in ON-Resistance vs. LED Current**

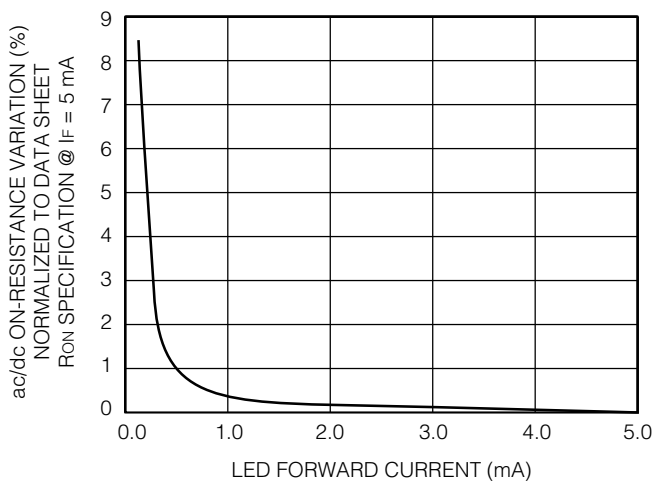

**Figure 12. Leakage Current vs. Applied Voltage at Elevated Temperatures**

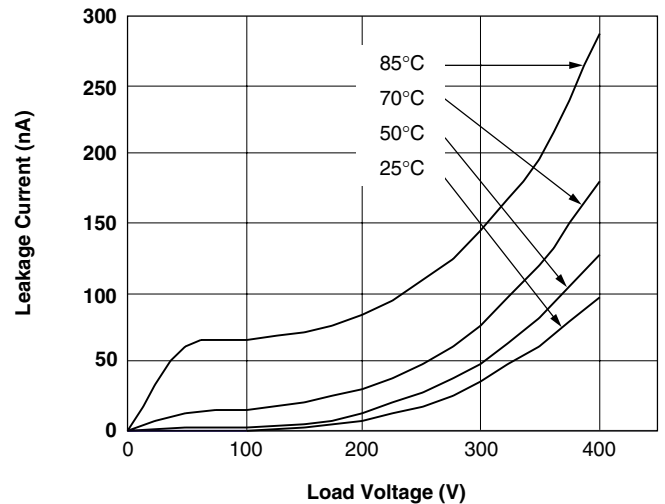

Figure 13. Insertion Loss vs. Frequency

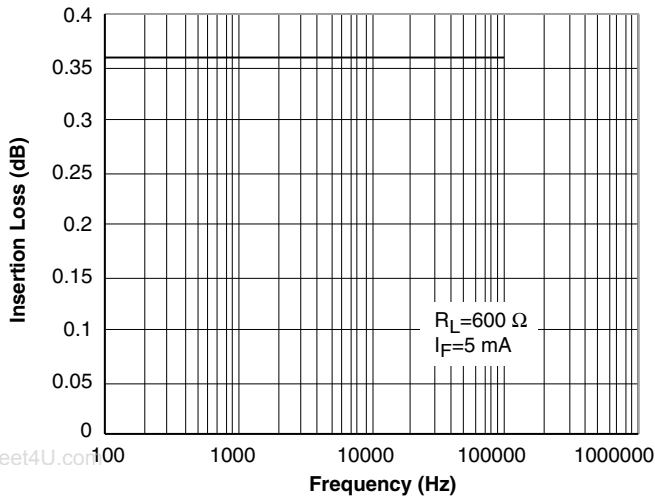

Figure 16. Switch Offset Voltage vs. Temperature

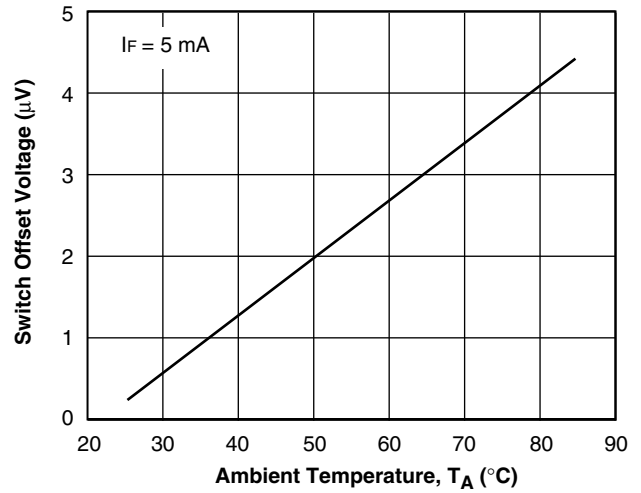

Figure 14. Switch Breakdown Voltage vs. Load Current

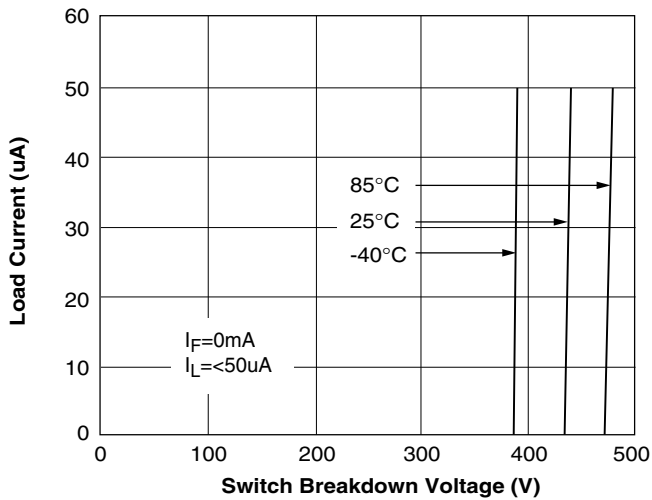

Figure 17. LED Offset Voltage vs. LED Current

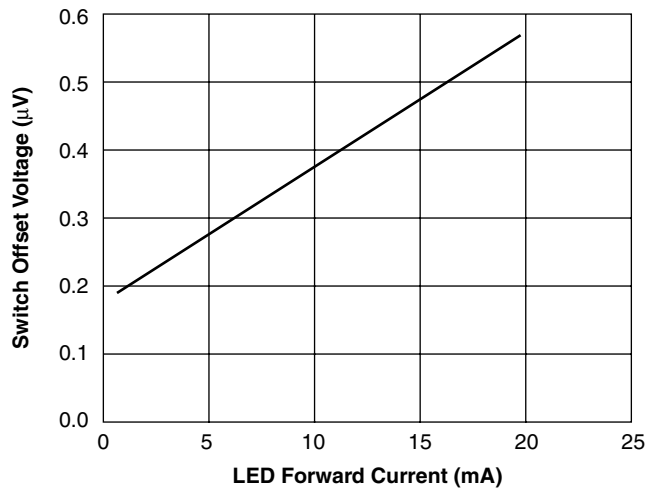

Figure 15. Switch Breakdown Voltage vs. Temperature

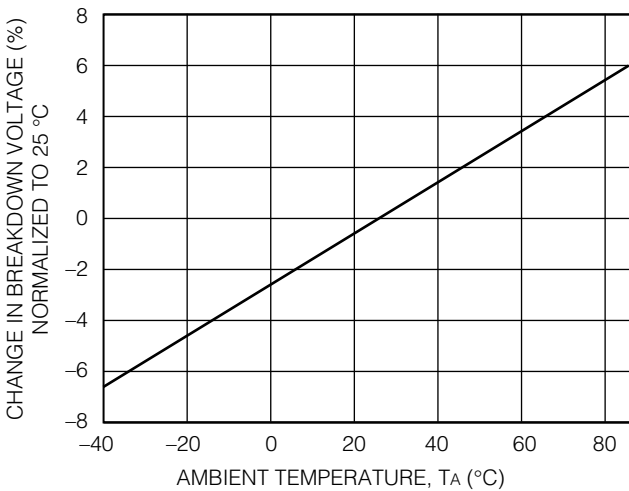

Figure 18. Turn-On Time vs. LED Current

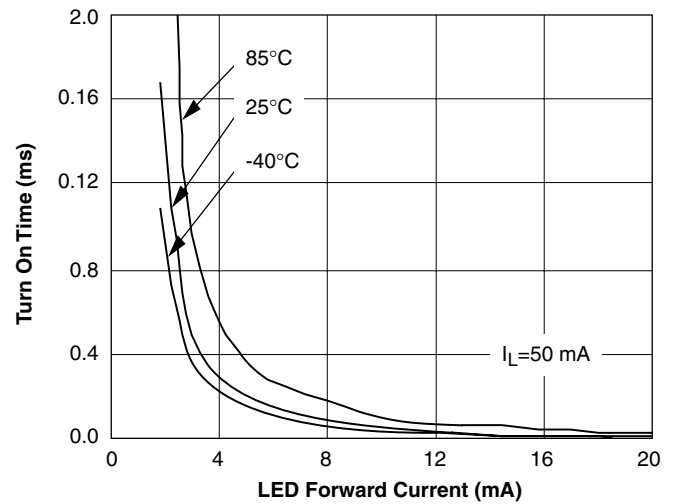

Figure 19. Turn-On Time vs. Temperature

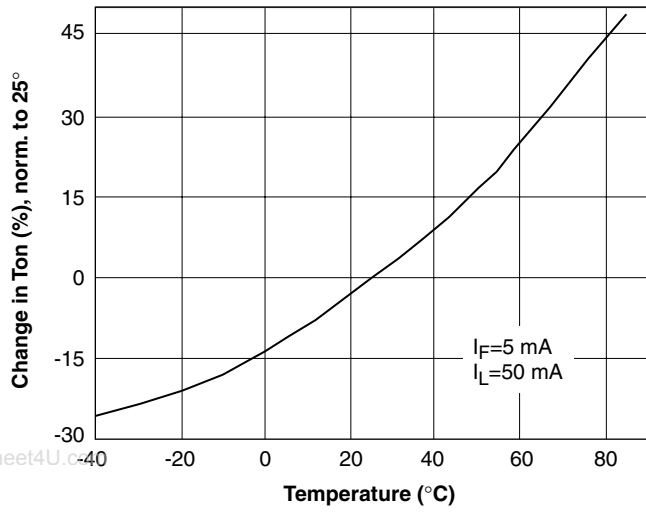

Figure 21. Turn-off Time vs. LED Current

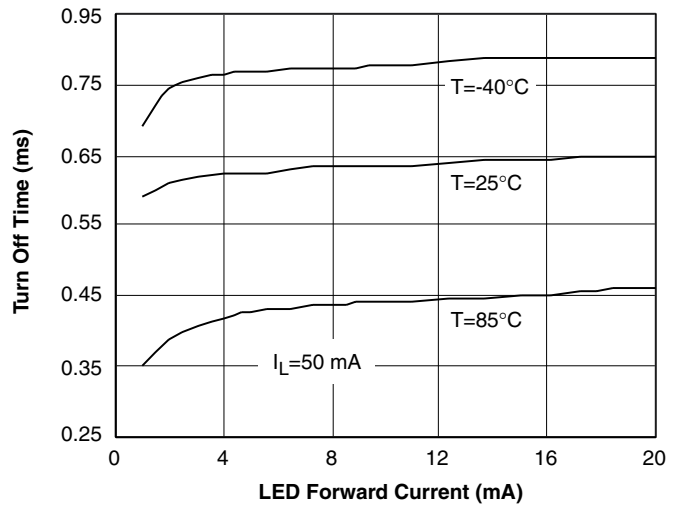
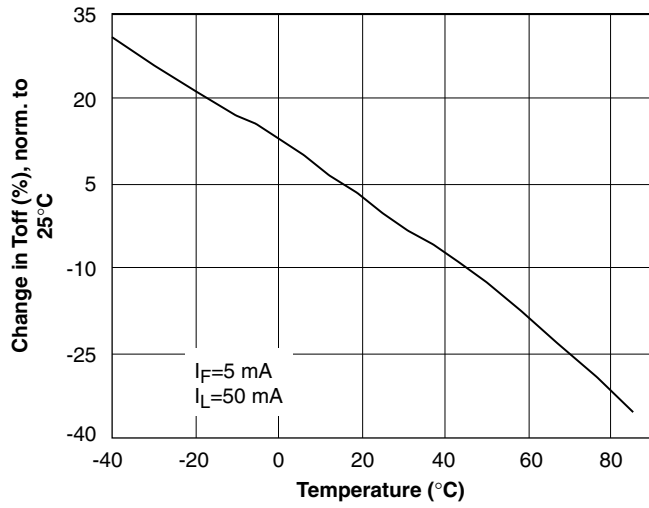

Figure 20. Turn-Off Time vs. Temperature



## Applications

### Input Control

The LH1525 low turn-on current SSR has highly sensitive photo-detection circuits that will detect even the most minute currents flowing through the LED. Leakage current must be considered when designing a circuit to turn on and off these relays.

Figure 19 shows a typical logic circuit for providing LED drive current. R1 is the input resistor that limits the amount of current flowing through the LED. For 5.0 V operation, a 2700  $\Omega$  resistor will limit the drive current to about 1.4 mA. Where high-speed actuation is desirable, use a lower value resistor for R1. An additional RC peaking circuit is not required with the LH1525 relay.

R2 is an optional pull-up resistor which pulls the logic level high output ( $V_{OH}$ ) up toward the VS potential. The pull-up resistance is set at a high value to minimize the overall current drawn from the VS. The primary purpose of this resistor is to keep the differential voltage across the LED below its turn-on threshold. LED dropout voltage is graphed vs. temperature in the Typical Performance Characteristics section. When the logic gate is high, leakage current will flow through R2. R2 will draw up to 8 mA before developing a voltage potential which might possibly turn on the LED.

Many applications will operate satisfactorily without a pull-up resistor. In the logic circuit in Figure 1 the only path for current to flow is back into the logic gate. Logic leakage is usually negligible. Each application should be evaluated, however, over the full operating temperature range to make sure that leakage current through the input control LED is kept to a value less than the minimum LED forward current for switch turn-off specification.

**Figure 22. Input Control Circuit**

