

Telecom Switch - 1 Form A Solid State Relay

Features

- Solid State Relay and Optocoupler in One Package
- Surface Mount Package
- I/O Isolation, 5300 V_{RMS}
- LH1529A, CTR Min. = 33 %
- LH1529B, CTR Min. = 100 %
- Optocoupler
 - Bidirectional Current Detection

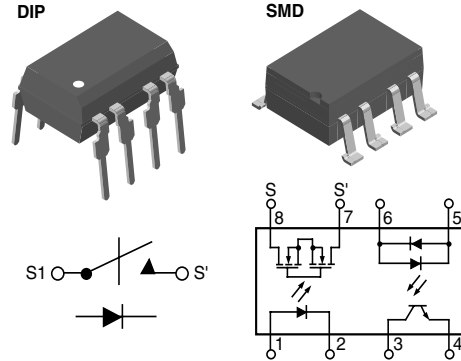

1179049

- Solid-state Relay (Equivalent to TS117P)
 - Typical R_{ON} 20 Ω
 - Load Voltage 350 V
 - Load Current 120 mA
 - Current Limit Protection
 - High Surge Capability
 - Linear, AC/DC Operation
 - Clean Bounce Free Switching
 - Low Power Consumption
 - High Reliability Monolithic Receptor

See Appnote 56

Description

The LH1529A and LH1529B Telecom switches consist of an optically coupled solid state relay (SSR) and bidirectional input optocoupler. The SSR is ideal for performing switch hook and dial-pulse switching while optocoupler performs ring detection and loop current sensing functions. Both the SSR and optocoupler provide 5300 V_{RMS} of input to output isolation.

Agency Approvals

- UL - File No. E52744
- BSI/BABT Cert. No. 7980
- FIMKO Approval

Applications

- General Telecom Switching
- On/off Hook Control
 - Dial Pulse
 - Ring Current Detection
 - Loop Current Sensing

Order Information

Part	Remarks
LH1529AB	DIP-8, Tubes
LH1529BB	DIP-8, Tubes
LH1529AAC	SMD-8, Tubes
LH1529BAC	SMD-8, Tubes
LH1529AACTR	SMD-8, Tape and Reel
LH1529BACTR	SMD-8, Tape and Reel

Absolute Maximum Ratings, $T_{amb} = 25\text{ }^{\circ}\text{C}$

Stresses in excess of the absolute Maximum Ratings can cause permanent damage to the device. Functional operation of the device is not implied at these or any other conditions in excess of those given in the operational sections of this document. Exposure to absolute Maximum Ratings for extended periods of time can adversely affect reliability.

SSR

Parameter	Test condition	Symbol	Value	Unit
LED continuous forward current		I_F	50	mA
LED reverse voltage	$I_R \leq 10\text{ }\mu\text{A}$	V_R	5.0	V
DC or peak AC load voltage	$I_L \leq 50\text{ }\mu\text{A}$	V_L	350	V
Continuous DC load current		I_L	120	mA
Total power dissipation		P_{diss}	600	mW
Ambient temperature range		T_{amb}	- 40 to + 85	$^{\circ}\text{C}$
Storage temperature range		T_{stg}	- 40 to + 150	$^{\circ}\text{C}$
Soldering temperature	$t = 10\text{ s max.}$	T_{sld}	260	$^{\circ}\text{C}$
Isolation test voltage (for 1.0 s)		V_{ISO}	5300	V_{RMS}
Isolation resistance	$V_{IO} = 500\text{ V}, T_{amb} = 25\text{ }^{\circ}\text{C}$	R_{IO}	$\geq 10^{12}$	Ω
	$V_{IO} = 500\text{ V}, T_{amb} = 100\text{ }^{\circ}\text{C}$	R_{IO}	$\geq 10^{11}$	Ω

Optocoupler

Parameter	Test condition	Symbol	Value	Unit
LED continuous forward current		I_F	50	mA
LED reverse voltage	$I_R \leq 10\text{ }\mu\text{A}$	V_R	5.0	V
Collector to emitter breakdown voltage		BV_{CEO}	30	V
Phototransistor power dissipation		P_{diss}	150	mW

Electrical Characteristics, $T_{amb} = 25\text{ }^{\circ}\text{C}$

Minimum and maximum values are testing requirements. Typical values are characteristics of the device and are the result of engineering evaluations. Typical values are for information only and are not part of the testing requirements.

SSR

Parameter	Test condition	Part	Symbol	Min	Typ.	Max	Unit
LED forward current for switch turn-on	$I_L = 100\text{ mA}, t = 10\text{ ms}$		I_{Fon}		0.7	2.0	mA
LED forward current for switch turn-off	$V_L = \pm 300\text{ V}$		I_{Foff}	0.2	0.6		mA
LED forward voltage	$I_F = 10\text{ mA}$		V_F	1.15	1.26	1.45	V
ON- resistance, AC/DC, pins 4 (\pm) to 6 (\pm)	$I_F = 5.0\text{ mA}, I_L = \pm 50\text{ mA}$		R_{ON}	12	20	25	Ω
Current limit	$I_F = 5.0\text{ mA}, t = 5.0\text{ ms}, V_L = \pm 6.0\text{ V}$	LH1529AB	I_{limit}	230	260	370	mA
		LH1529AAC	I_{limit}	230	260	370	mA
		LH1529BB	I_{limit}	170	210	250	mA
		LH1529BAC	I_{limit}	170	210	250	mA
Off-state leakage current	$I_F = 0\text{ mA}, V_L = \pm 100\text{ V}$				0.02	200	nA
	$I_F = 0\text{ mA}, V_L = \pm 350\text{ V}$					1.0	μA



Parameter	Test condition	Part	Symbol	Min	Typ.	Max	Unit
Output capacitance pin 7 to pin 8	$I_F = 0 \text{ mA}, V_L = 1 \text{ V}$				55		pF
	$I_F = 0 \text{ mA}, V_L = 50 \text{ V}$				10		pF
Input/output capacitance	$V_{ISO} = 1.0 \text{ V}$		C_{ISO}		1.3		pF
Turn-on time	$I_F = 5.0 \text{ mA}, I_L = 50 \text{ mA}$	LH1529AB	t_{on}		2.0	3.0	ms
		LH1529AAC	t_{on}		2.0	3.0	ms
		LH1529BB	t_{on}		1.3	2.5	ms
		LH1529BAC	t_{on}		1.3	2.5	ms
Turn-off time	$I_F = 5.0 \text{ mA}, I_L = 50 \text{ mA}$	LH1529AB	t_{off}		0.6	3.0	ms
		LH1529AAC	t_{off}		0.6	3.0	ms
		LH1529BB	t_{off}		0.6	2.5	ms
		LH1529BAC	t_{off}		0.6	2.5	ms

Optocoupler

Parameter	Test condition	Part	Symbol	Min	Typ.	Max	Unit
LED forward voltage	$I_F = 10 \text{ mA}$		V_F	0.9	1.2	1.5	V
Saturation voltage	$I_F = 16 \text{ mA}, I_C = 2.0 \text{ mA}$		V_{CEsat}		0.7	0.5	V
Dark current leakage	$I_F = 0 \text{ mA}, V_{CE} = 5.0 \text{ V}$		I_{CEO}			500	nA
Trickle current leakage	$I_F = 5.0 \mu\text{A}, V_{CE} = 5.0 \text{ V}$		I_{CEO}			1.0	μA
DC current transfer ratio	$I_F = 6.0 \text{ mA}, V_{CE} = 0.5 \text{ V}$	LH1529AB	CTR	33	100		%
		LH1529AAC	CTR	33	100		%
		LH1529BB	CTR	100	165		%
		LH1529BAC	CTR	100	165		%

Typical Characteristics ($T_{amb} = 25 \text{ }^\circ\text{C}$ unless otherwise specified)

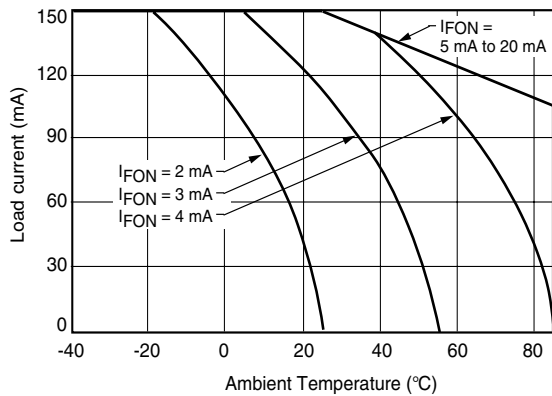

Figure 1. Recommended Operating Conditions

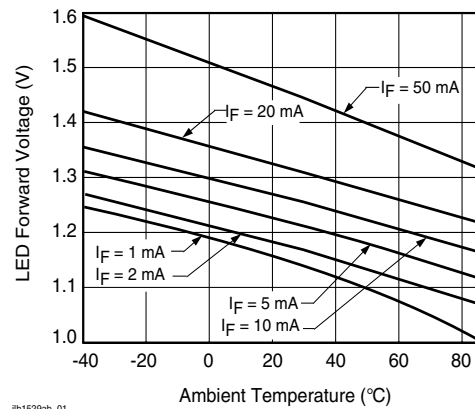

Figure 2. LED Voltage vs. Temperature

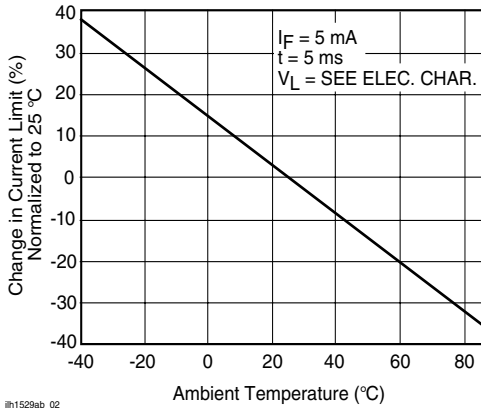

Figure 3. Current Limit vs. Temperature

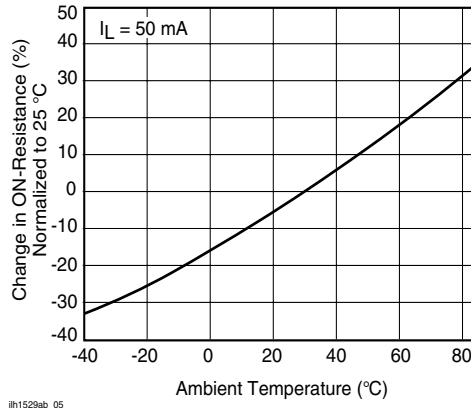

Figure 6. ON-Resistance vs. Temperature

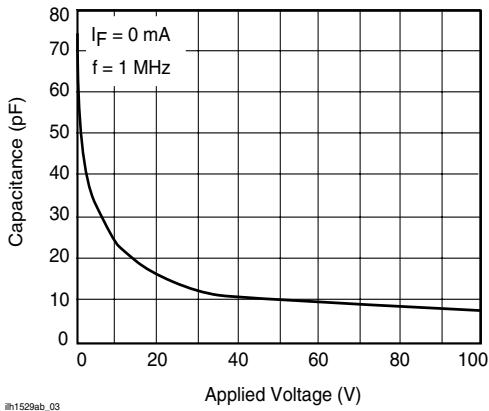

Figure 4. Switch Capacitance vs. Applied Voltage

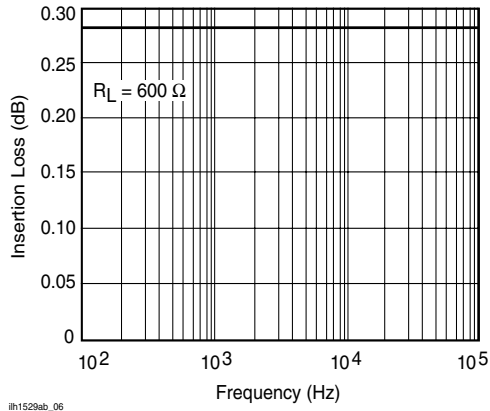

Figure 7. Insertion Loss vs. Frequency

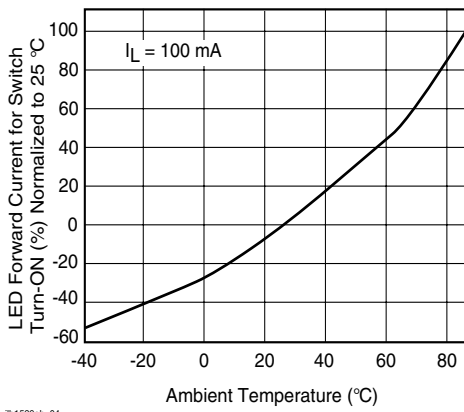

Figure 5. LED Current for Switch Turn-off vs. Temperature

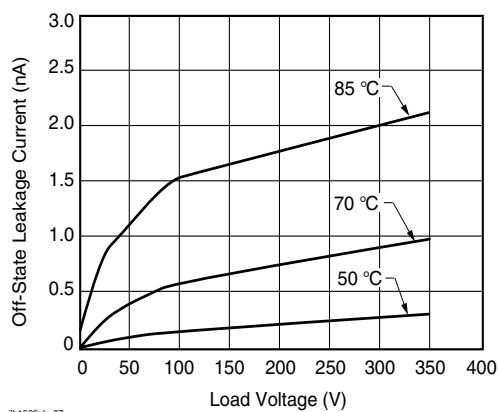
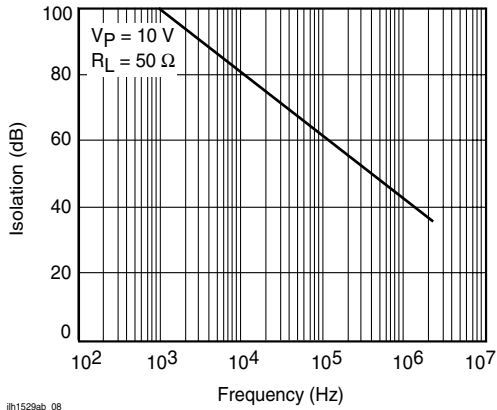
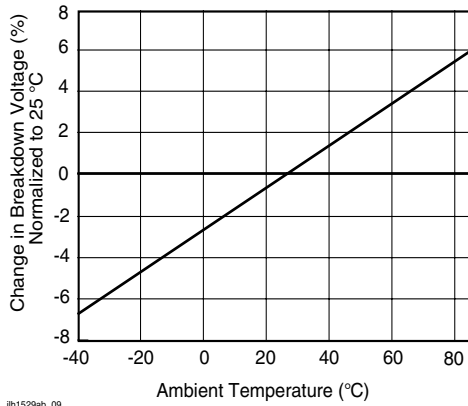

Figure 8. Leakage Current vs. Applied Voltage at Elevated Temperatures



ih1529ab_08

Figure 9. Output Isolation



ih1529ab_09

Figure 10. Switch Breakdown Voltage vs. Temperature

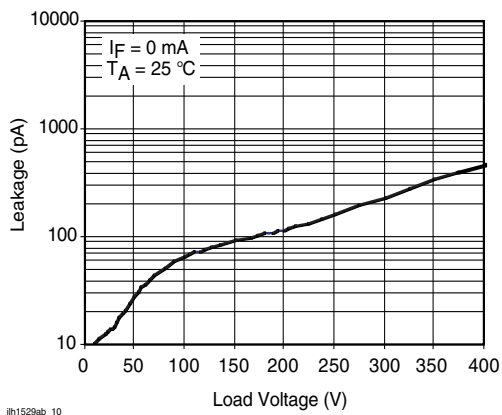

ih1529ab_10

Figure 11. Leakage Current vs. Applied Voltage

LH1529AB/ AAC/ AACTR/ BB/ BAC/



Vishay Semiconductors

Package Dimensions in Inches (mm)

DIP

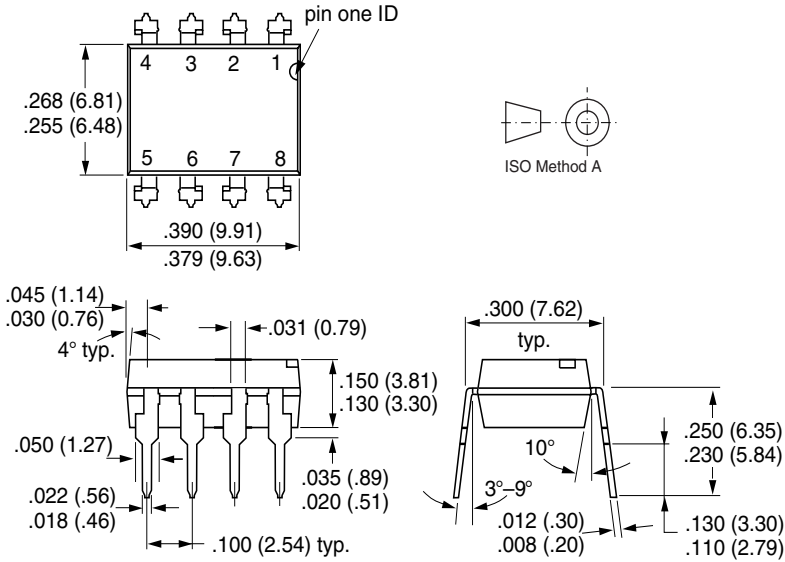

i178008

SMD

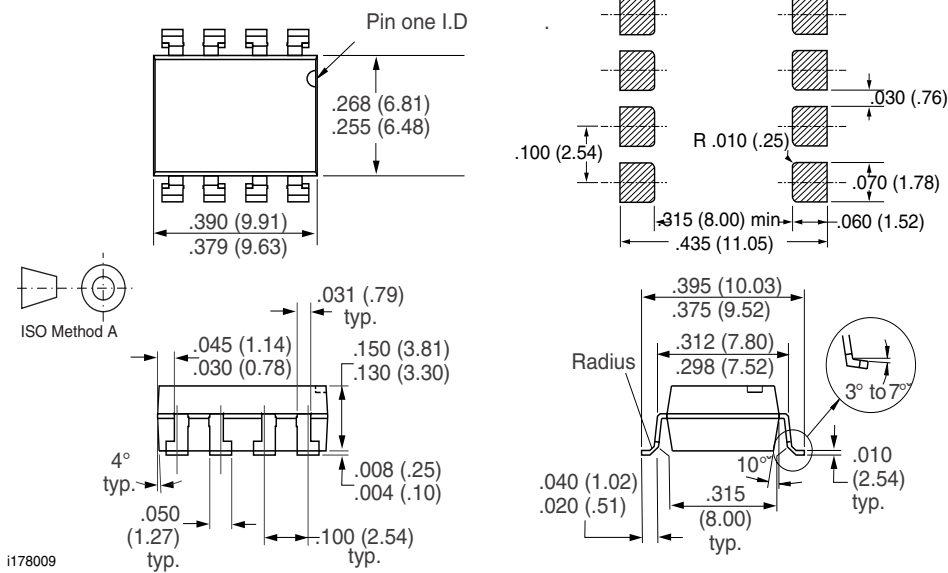

i178009



Ozone Depleting Substances Policy Statement

It is the policy of **Vishay Semiconductor GmbH** to

1. Meet all present and future national and international statutory requirements.
2. Regularly and continuously improve the performance of our products, processes, distribution and operating systems with respect to their impact on the health and safety of our employees and the public, as well as their impact on the environment.

It is particular concern to control or eliminate releases of those substances into the atmosphere which are known as ozone depleting substances (ODSs).

The Montreal Protocol (1987) and its London Amendments (1990) intend to severely restrict the use of ODSs and forbid their use within the next ten years. Various national and international initiatives are pressing for an earlier ban on these substances.

Vishay Semiconductor GmbH has been able to use its policy of continuous improvements to eliminate the use of ODSs listed in the following documents.

1. Annex A, B and list of transitional substances of the Montreal Protocol and the London Amendments respectively
2. Class I and II ozone depleting substances in the Clean Air Act Amendments of 1990 by the Environmental Protection Agency (EPA) in the USA
3. Council Decision 88/540/EEC and 91/690/EEC Annex A, B and C (transitional substances) respectively.

Vishay Semiconductor GmbH can certify that our semiconductors are not manufactured with ozone depleting substances and do not contain such substances.

**We reserve the right to make changes to improve technical design
and may do so without further notice.**

Parameters can vary in different applications. All operating parameters must be validated for each customer application by the customer. Should the buyer use Vishay Semiconductors products for any unintended or unauthorized application, the buyer shall indemnify Vishay Semiconductors against all claims, costs, damages, and expenses, arising out of, directly or indirectly, any claim of personal damage, injury or death associated with such unintended or unauthorized use.

Vishay Semiconductor GmbH, P.O.B. 3535, D-74025 Heilbronn, Germany
Telephone: 49 (0)7131 67 2831, Fax number: 49 (0)7131 67 2423