



# LH1540AT/AAB/AABTR

## 1 Form A Solid State Relay

### FEATURES

- Current Limit Protection
- I/O Isolation, 5300 V<sub>RMS</sub>
- Typical R<sub>ON</sub> 20 Ω, max 25 Ω
- Load Voltage 350 V
- Load Current 120 mA
- High Surge Capability
- Linear, AC/DC Operation
- Clean Bounce Free Switching
- Low Power Consumption
- High Reliability Monolithic Receptor
- SMD lead available on tape and reel
- Flammability; UL94,VØ

### AGENCY APPROVALS

- UL – File No. E52744
- BSI/BABT Cert. No. 7980
- FIMKO Approval
- CSA – Certification 093751

### APPLICATIONS

- General Telecom Switching
  - On/off Hook Control
  - Ring Delay
  - Dial Pulse
  - Ground Start
  - Ground Fault Protection
- Instrumentation
- Industrial Controls
- See Application Note 56

### DESCRIPTION

The LH1540 is robust, ideal for telecom and ground fault applications. It is a SPST normally open switch (1 Form A) that replaces electromechanical relays in many applications. It is constructed using a GaAlAs LED for actuation control and an integrated monolithic die for the switch output. The die, fabricated in a high-voltage dielectrically isolated technology, is comprised of a photodiode array, switch control circuitry and MOSFET switches. In addition, it employs current-limiting circuitry which meets FCC 68.302 and other regulatory voltage surge requirements when overvoltage protection is provided.

Package Dimensions in Inches (mm)

#### DIP

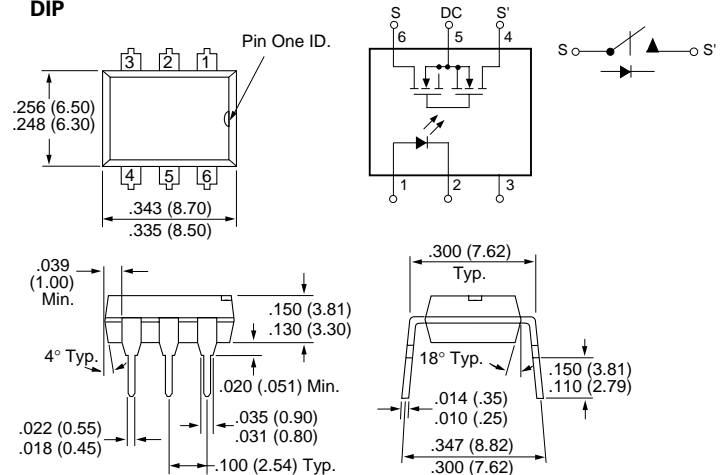

#### SMD

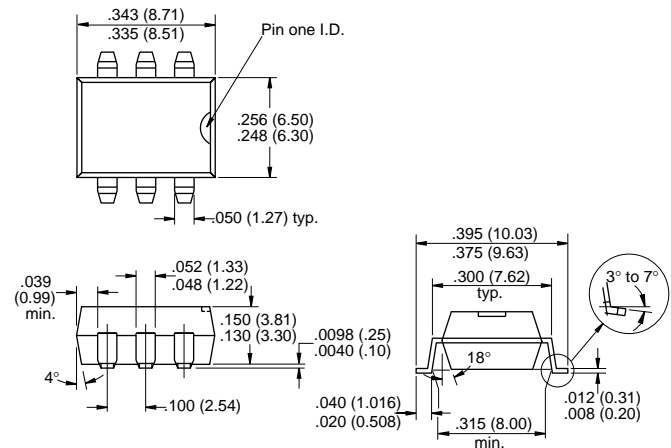

### Part Identification

Part Number	Description
LH1540AT	6-pin DIP, Thru Hole
LH1540AAB	6-pin SMD
LH1540AABTR	6-pin SMD, Tape and Reel

## Recommended Operating Conditions

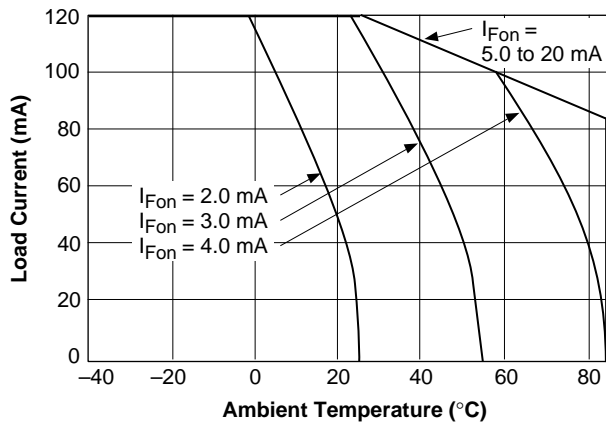

## Absolute Maximum Ratings, $T_A=25^\circ\text{C}$

Stresses in excess of the absolute Maximum Ratings can cause permanent damage to the device. These are absolute stress ratings only. Functional operation of the device is not implied at these or any other conditions in excess of those given in the operational sections of this document. Exposure to absolute Maximum Ratings for extended periods of time can adversely affect reliability.

Ambient Temperature Range ( $T_A$ )	.....	-40 to +85°C
Storage Temperature Range ( $T_{stg}$ )	.....	-40 to +150°C
Pin Soldering Temperature ( $t=10$ s max) ( $T_S$ )	.....	260°C
Input/Output Isolation Voltage ( $V_{ISO}$ )	.....	5300 $V_{RMS}$
LED Continuous Forward Current ( $I_F$ )	.....	50 mA
LED Reverse Voltage ( $I_F \leq 10 \mu\text{A}$ ) ( $V_R$ )	.....	8.0 V
DC or Peak AC Load Voltage ( $I_L \leq 50 \mu\text{A}$ ) ( $V_L$ )	.....	350 V
Continuous DC Load Current ( $I_L$ )		
Bidirectional Operation	.....	120 mA
Unidirectional Operation	.....	250 mA
Peak Load Current ( $t=100$ ms) (single shot) ( $I_P$ )	.....	†
Output Power Dissipation (continuous) ( $P_{DISS}$ )	.....	550 mW

† Refer to Current Limit Performance Application Note for a discussion on relay operation during transient currents.

## Electrical Characteristics, $T_A=25^\circ\text{C}$

Minimum and maximum values are testing requirements. Typical values are characteristics of the device and are the result of engineering evaluations. Typical values are for information only and are not part of the testing requirements.

Parameter	Sym.	Min.	Typ.	Max.	Units	Test Conditions
<b>Input</b>						
LED Forward Current, Switch Turn-on	$I_{Fon}$	—	1.0	2.0	mA	$I_L=100$ mA, $t=10$ ms
LED Forward Current, Switch Turn-off	$I_{Foff}$	0.2	0.9	—	mA	$V_L \pm 300$ V
LED Forward Voltage	$V_F$	1.15	1.26	1.45	V	$I_F=10$ mA
<b>Output</b>						
ON-resistance ac/dc: Pin 4 ( $\pm$ ) to 6 ( $\pm$ )	$R_{ON}$	12	20	25	$\Omega$	$I_F=5.0$ mA, $I_L=50$ mA
dc: Pin 4, 6 (+) to 5 ( $\pm$ )		3.0	5.0	6.25		$I_F=5.0$ mA, $I_L=100$ mA
OFF-resistance	$R_{OFF}$	0.5	5000	—	G $\Omega$	$I_F=0$ mA, $V_L=\pm 100$ V
Current Limit ac/dc: Pin 4 ( $\pm$ ) to 6 ( $\pm$ )	$I_{LMT}$	175	210	250	mA	$I_F=5.0$ mA, $t=5.0$ ms $V_L=\pm 6.0$ V
dc: Pin 4, 6 (+) to 5 ( $\pm$ )		—	—	—		$I_F=5.0$ mA, $t=5.0$ ms $V_L=\pm 4.0$ V
Off-state Leakage Current	—	—	0.32	200	nA	$I_F=0$ mA, $V_L=\pm 100$ V
		—	1.0	350	$\mu\text{A}$	$I_F=0$ mA, $V_L=\pm 350$ V
Output Capacitance Pin 4 to 6	—	—	55	—	pF	$I_F=0$ mA, $V_L=1.0$ V
		—	10	—		$I_F=0$ mA, $V_L=50$ V
Switch Offset	—	—	0.15	—	V	$I_F=5.0$ mA
<b>Transfer</b>						
Input/Output Capacitance	$C_{ISO}$	—	0.8	—	pF	$V_{ISO}=1.0$ V
Turn-on Time	$t_{on}$	—	1.2	2.0	ms	$I_F=5.0$ mA, $I_L=50$ mA
Turn-off Time	$t_{off}$	—	0.5	2.0	ms	$I_F=5.0$ mA, $I_L=50$ mA

Typical Performance Characteristics

Figure 1. LED Voltage vs. Temperature

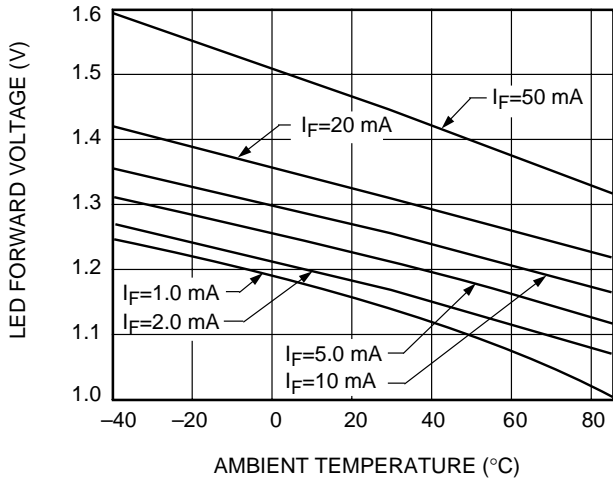

Figure 4. Current Limit vs. Temperature

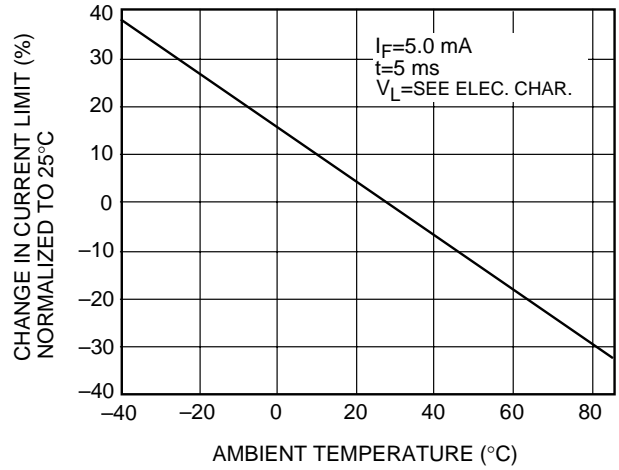

Figure 2. LED Dropout Voltage vs. Temperature

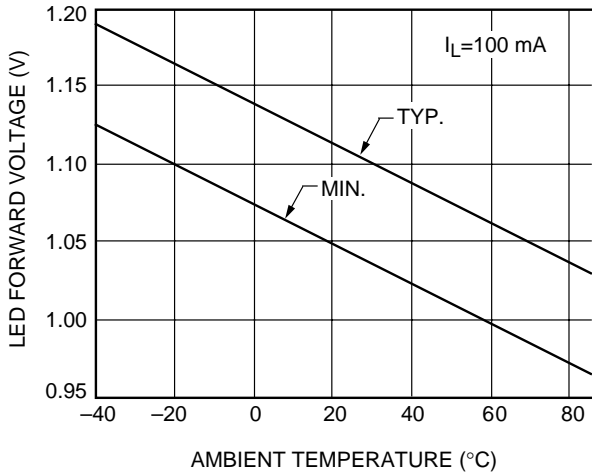

Figure 5. ON-Resistance vs. Temperature

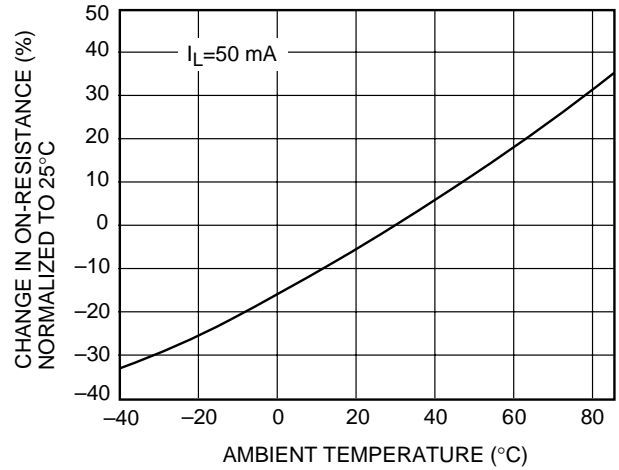

Figure 3. LED Current for Switch Turn-on vs. Temperature

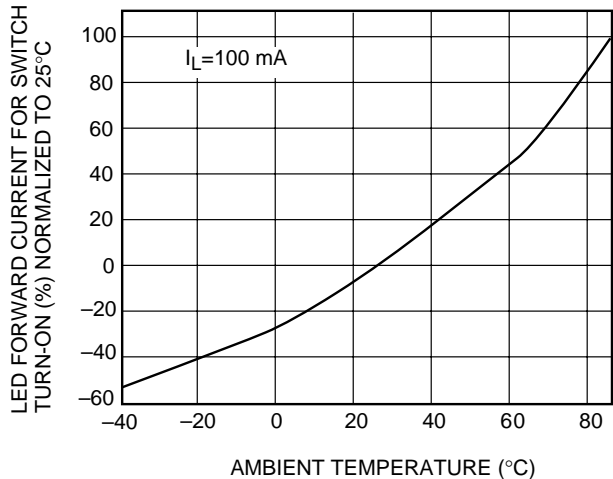
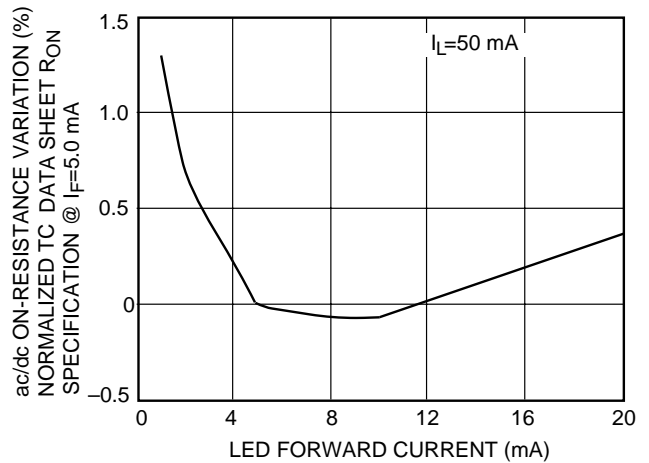
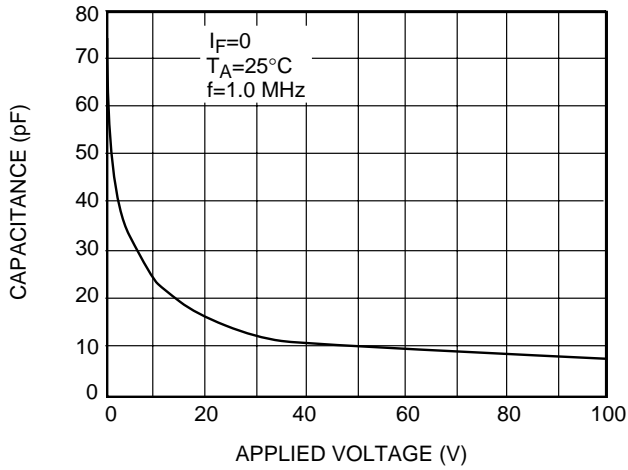

Figure 6. Variation in ON-Resistance vs. LED Current



**Figure 7. Switch Capacitance vs. Applied Voltage**



**Figure 10. Leakage Current vs. Applied Voltage**

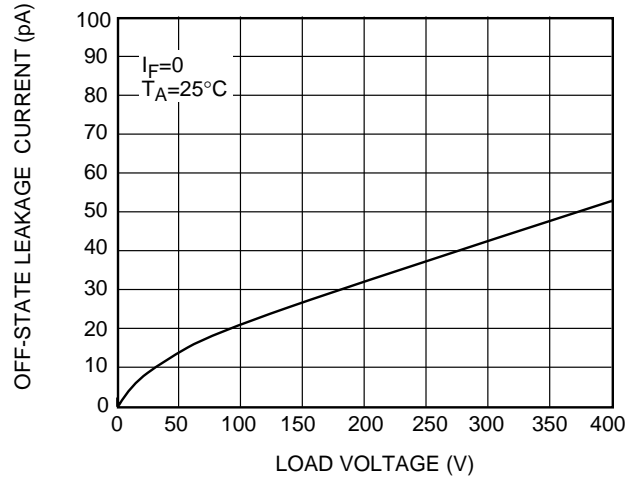

**Figure 8. Insertion Loss vs. Frequency**

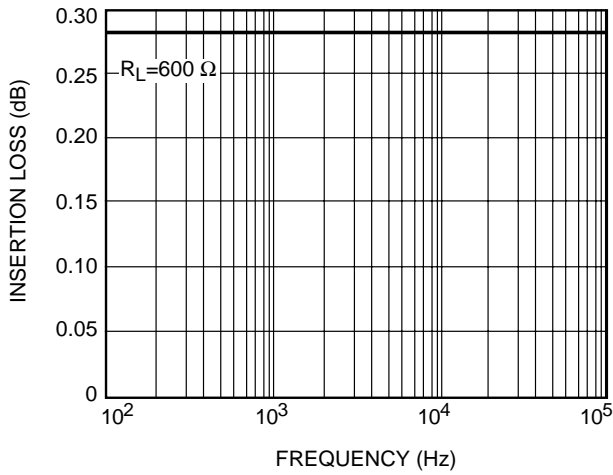

**Figure 11. Leakage Current vs. Applied Voltage at Elevated Temperatures**

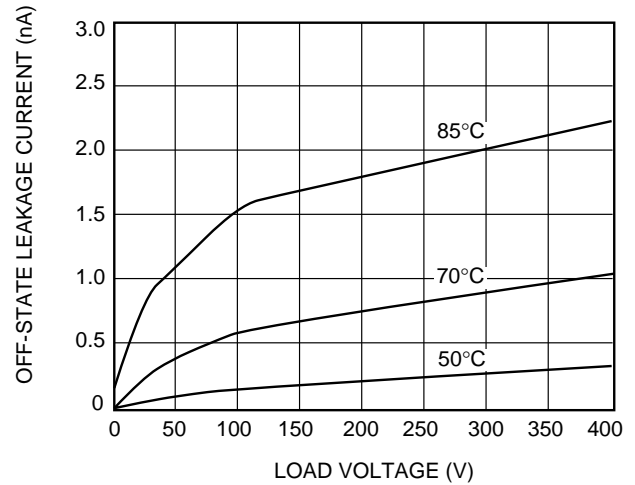

**Figure 9. Output Isolation**

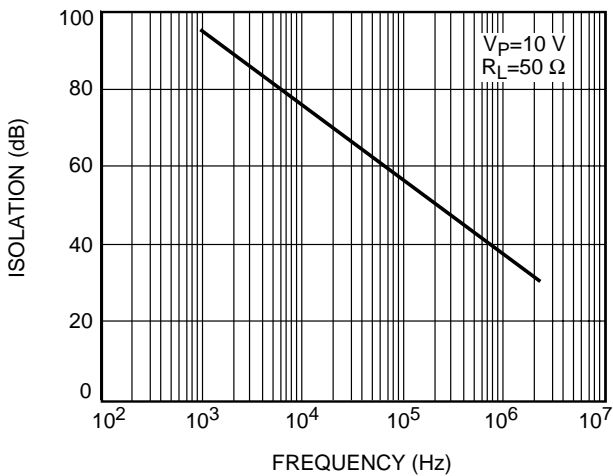

**Figure 12. Switch Breakdown Voltage vs. Temperature**

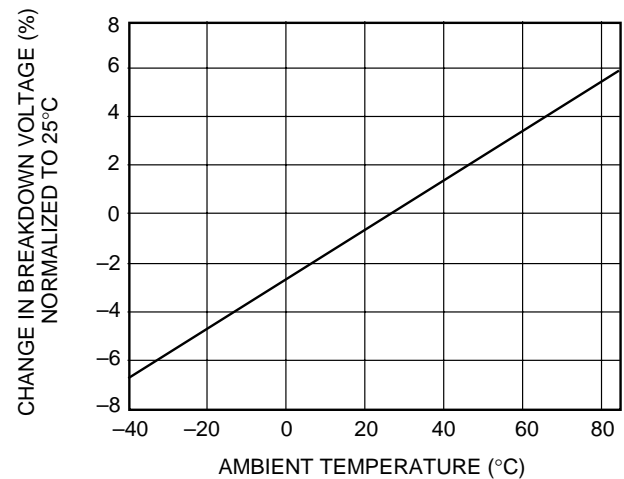

**Figure 13. Switch Offset Voltage vs. Temperature**

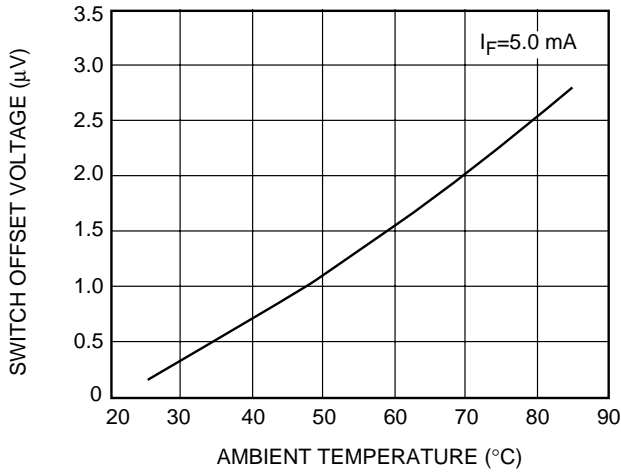

**Figure 16. Turn-off Time vs. Temperature**

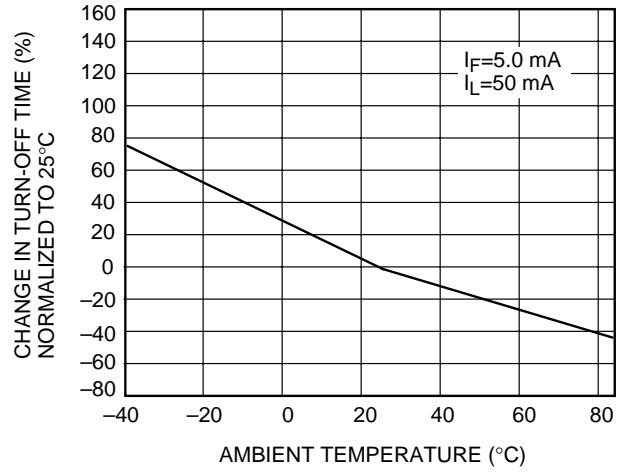

**Figure 14. Switch Offset Voltage vs. LED Current**

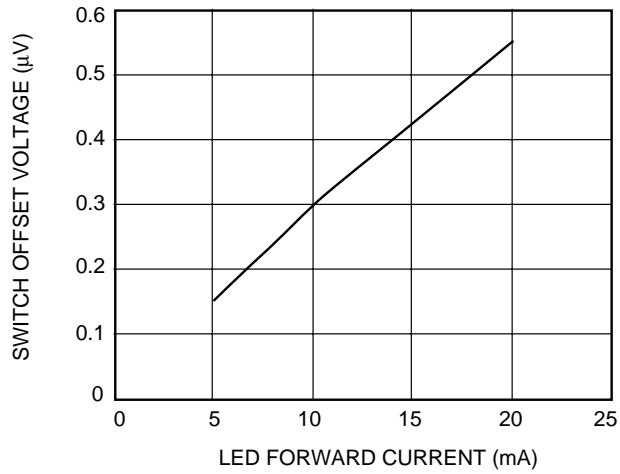

**Figure 17. Turn-on Time vs. LED Current**

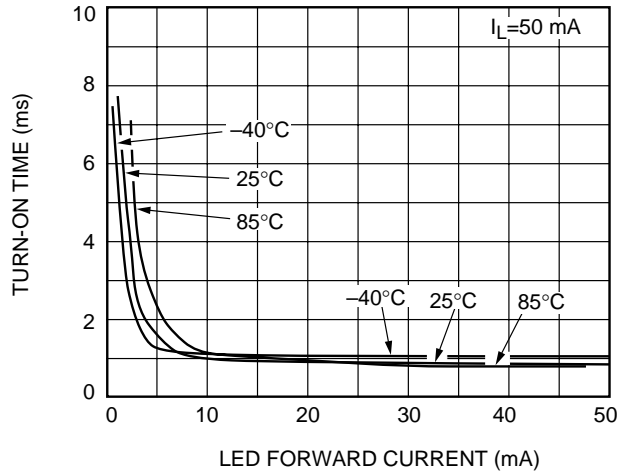

**Figure 15. Turn-on Time vs. Temperature**

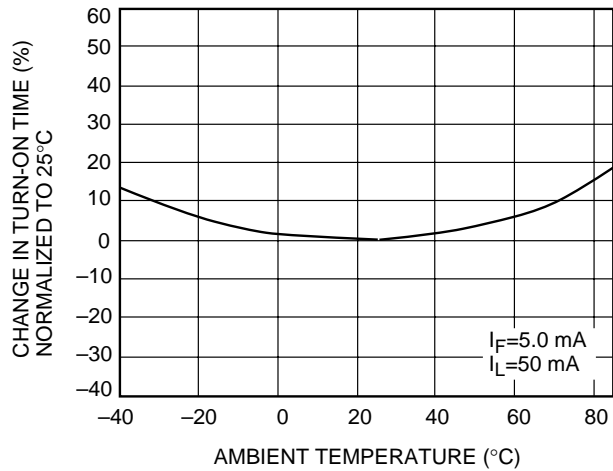

**Figure 18. Turn-off Time vs. LED Current**

