



LH1541AT1/AAB1/AAB1TR

1 Form A
Solid State Relay
(Low Capacitance)

FEATURES

- Low Capacitance Switch (5.0 pF)
- I/O Isolation, 5300 V_{RMS}
- Extremely High OFF-resistance (100 TΩ)
- Load Voltage 350 V
- Linear, AC/DC Operation
- Clean Bounce Free Switching
- Low Power Consumption
- High Reliability Monolithic Receptor

AGENCY APPROVALS

- UL – File No. E52744
- CSA – Certification 093751
- BSI/BABT Cert. No. 7980
- VDE 0884 Approval
- FIMKO Approval

APPLICATIONS

- Instrumentation
 - Thermocouple Switching
 - Analog Multiplexing
- Reed Relay Replacement
- Programmable Logic Controllers
- Data Acquisition
- Test Equipment

DESCRIPTION

These SSRs (LH1541, 1 Form A) are SPST normally open switches which can replace electromechanical relays in many applications. The relays provide a low-capacitance, high-voltage switch contact with high off-resistance and low switch-offset voltage. These characteristics, combined with high-speed actuation, result in an SSR which is ideal for small signal and dc instrumentation applications.

The relays are constructed by using a GaAlAs LED for actuation control and an integrated monolithic die for the switch output. The die is comprised of a photodiode array, switch-control circuitry, and low-capacitance MOS-FET switches.

Package Dimensions in Inches (mm)

DIP

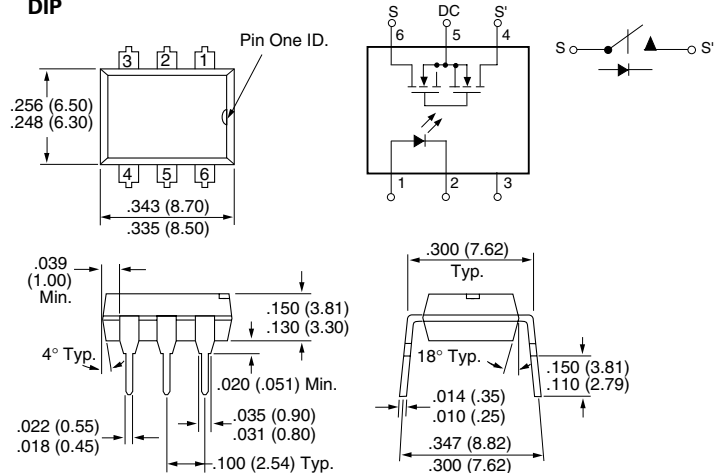

SMD

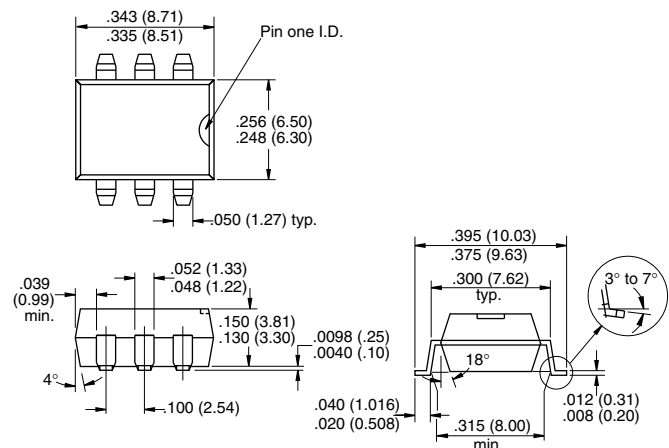

Part Identification

Part Number	Description
LH1541AT1	6-pin DIP, Tubes
LH1541AAB1	6-pin SMD, Gullwing, Tubes
LH1541AAB1TR	6-pin SMD, Gullwing, Tape and Reel

Recommended Operating Conditions

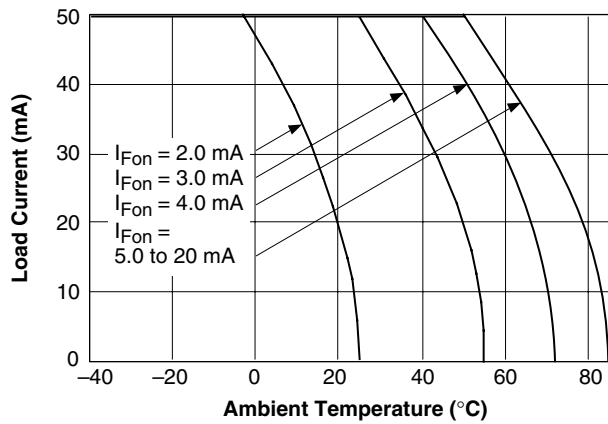

Absolute Maximum Ratings, $T_A=25^\circ\text{C}$

Stresses in excess of the absolute Maximum Ratings can cause permanent damage to the device. These are absolute stress ratings only. Functional operation of the device is not implied at these or any other conditions in excess of those given in the operational sections of this document. Exposure to absolute Maximum Ratings for extended periods of time can adversely affect reliability.

Ambient Temperature Range (T_A)	-40 to +85°C
Storage Temperature Range (T_{stg})	-40 to +150°C
Pin Soldering Temperature (t=10 s max) (T_S)	260°C
Input/Output Isolation Voltage		
(V_{RMS} t=1.0 s, $I_{ISO}=10 \mu\text{A}$ max) (V_{ISO})	5300 V_{RMS}
LED Continuous Forward Current (I_F)	50 mA
LED Reverse Voltage ($I_R \leq 10 \mu\text{A}$) (V_R)	8.0 V
DC or Peak AC Load Voltage ($I_L \leq 50 \mu\text{A}$) (V_L)	200 V
Continuous DC Load Current (I_L)		
Bidirectional Operation	55 mA
Unidirectional Operation	— mA
Peak Load Current (t=100 ms) (single shot) (I_P)	100 mA
Output Power Dissipation (continuous) (P_{DISS})	550 mW

Electrical Characteristics, $T_A=25^\circ\text{C}$

Minimum and maximum values are testing requirements. Typical values are characteristics of the device and are the result of engineering evaluations. Typical values are for information only and are not part of the testing requirements.

Parameter	Sym.	Min.	Typ.	Max.	Units	Test Conditions
Input						
LED Forward Current, Switch Turn-on	I_{Fon}	—	0.6	2.0	mA	$I_L=100 \text{ mA}$, t=10 ms
LED Forward Current, Switch Turn-off	I_{Foff}	0.1	0.5	—	mA	$V_L \pm 150 \text{ V}$
LED Forward Voltage	V_F	1.10*	1.19*	1.45*	V	$I_F=10 \text{ mA}$
Output						
ON-resistance ac/dc: Pin 4 (\pm) to 6 (\pm)	R_{ON}	70	110	160	Ω	$I_F=5.0 \text{ mA}$, $I_L=50 \text{ mA}$
dc: Pin 4, 6 (+) to 5 (\pm)		—	—	—		$I_F=5.0 \text{ mA}$, $I_L=100 \text{ mA}$
OFF-resistance	R_{OFF}	0.5	10000	—	G Ω	$I_F=0 \text{ mA}$, $V_L=\pm 100 \text{ V}$
Off-state Leakage Current	—	—	0.4	200	nA	$I_F=0 \text{ mA}$, $V_L=\pm 100 \text{ V}$
			—	—	1.0	μA
Output Capacitance Pin 4 to 6	—	—	4.8	—	pF	$I_F=0 \text{ mA}$, $V_L=1.0 \text{ V}$
			—	36		—
Switch Offset	—	—	0.15	—	V	$I_F=5.0 \text{ mA}$
Transfer						
Input/Output Capacitance	C_{ISO}	—	0.8	—	pF	$V_{ISO}=1.0 \text{ V}$
Turn-on Time	t_{on}	—	0.12	0.25	ms	$I_F=5.0 \text{ mA}$, $I_L=50 \text{ mA}$
Turn-off Time	t_{off}	—	0.3	0.25	ms	$I_F=5.0 \text{ mA}$, $I_L=50 \text{ mA}$

* $I_F=5.0 \text{ mA}$

Typical Performance Characteristics

Figure 1. LED Voltage vs. Temperature

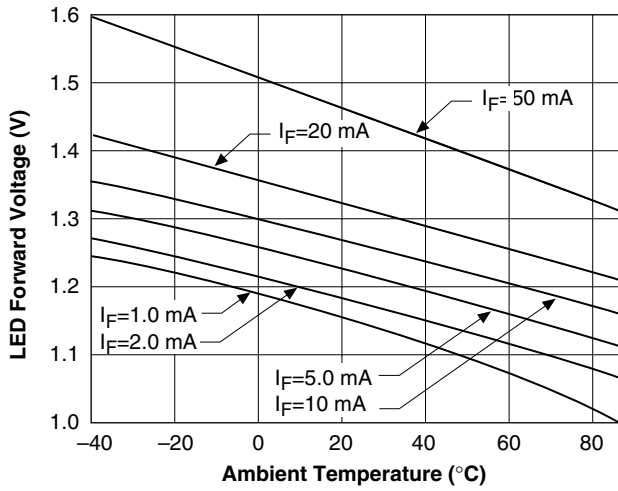

Figure 4. LED Current for Switch Turn-on vs. Temperature

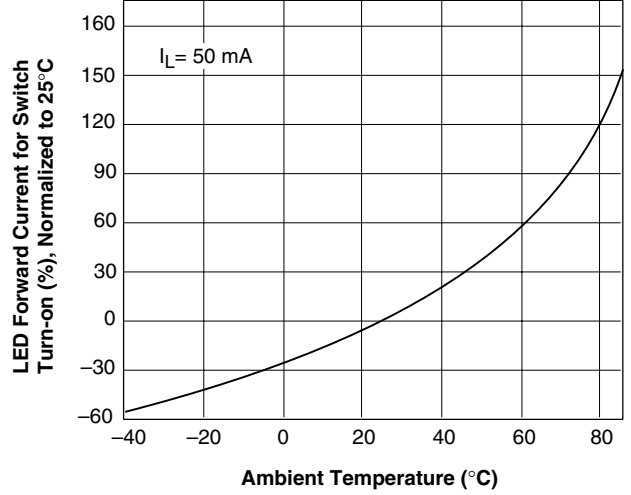

Figure 2. Current Limit vs. Temperature

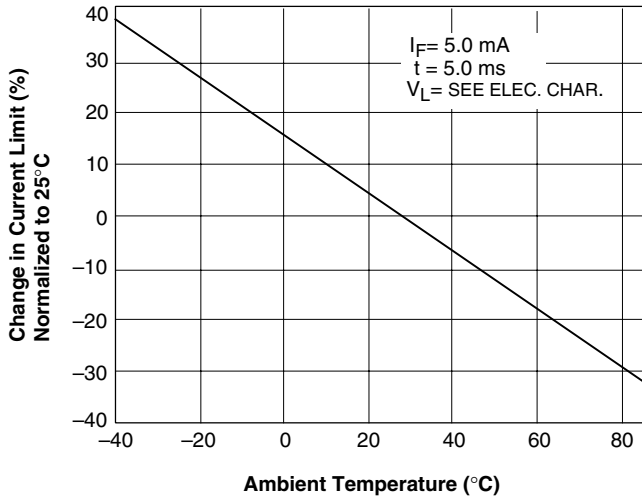

Figure 5. On-resistance vs. Temperature

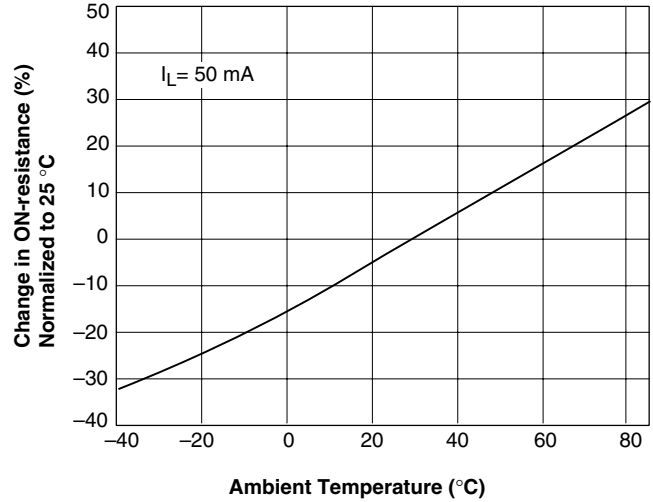

Figure 3. LED Dropout Voltage vs. Temperature

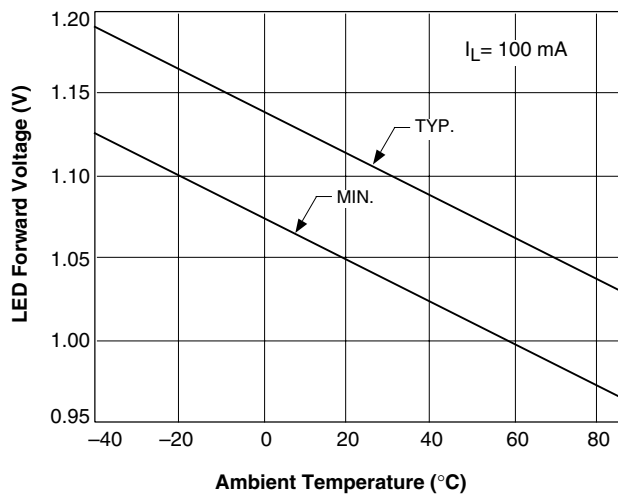

Figure 6. Switch Capacitance vs. Applied Voltage

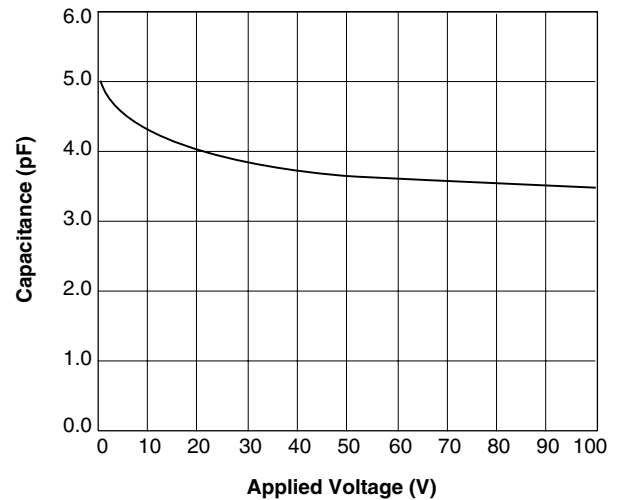

Figure 7. Insertion Loss vs. Frequency

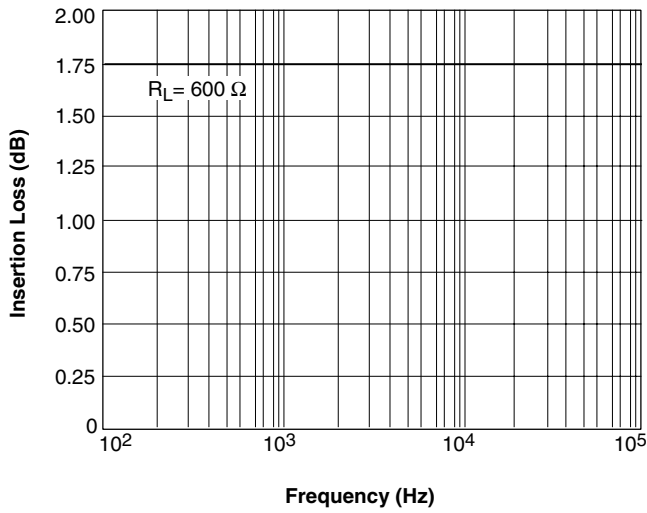

Figure 10. Switch Offset Voltage vs. Temperature

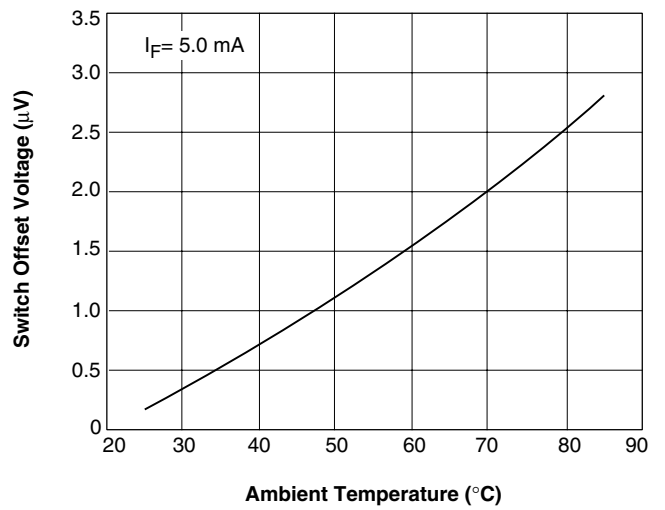

Figure 8. Leakage Current vs. Applied Voltage

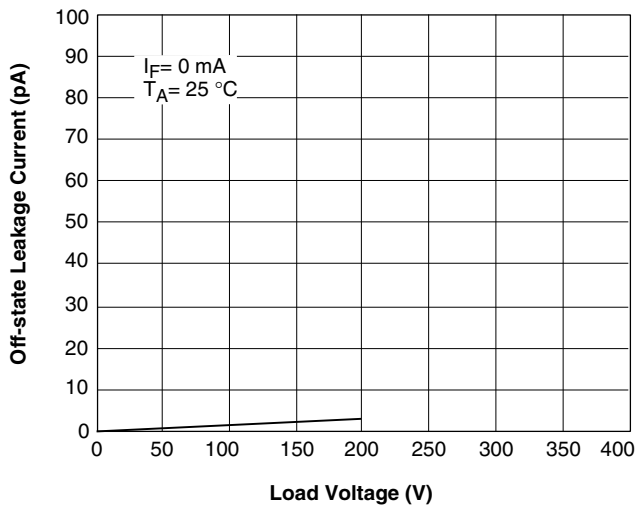

Figure 11. Leakage Current vs. Applied Voltage at Elevated Temperatures

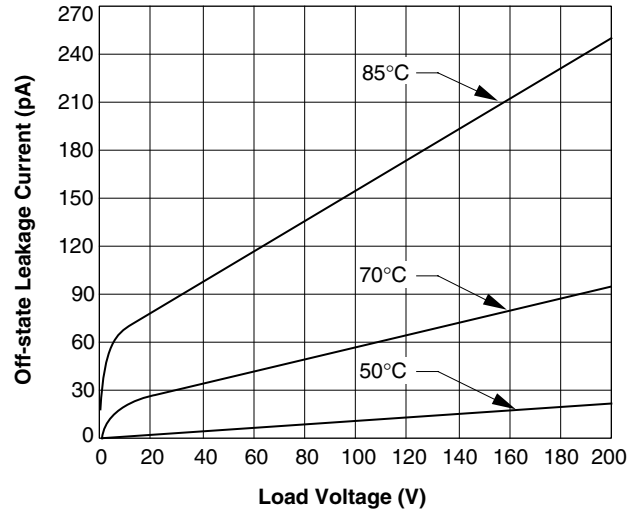

Figure 9. Output Isolation

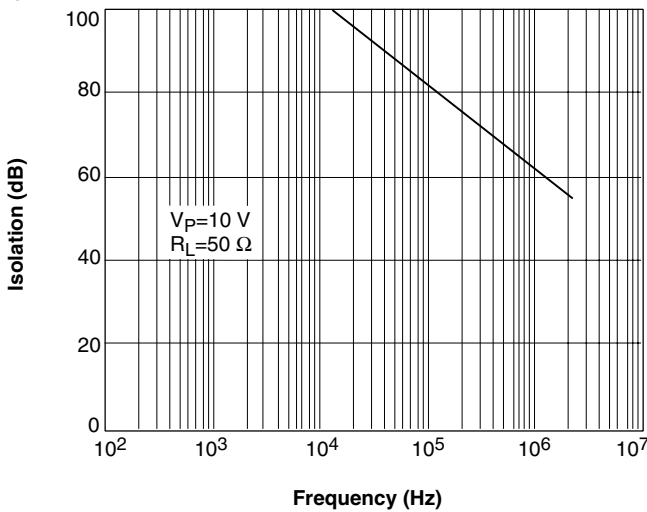

Figure 12. Switch Breakdown Voltage vs. Temperature

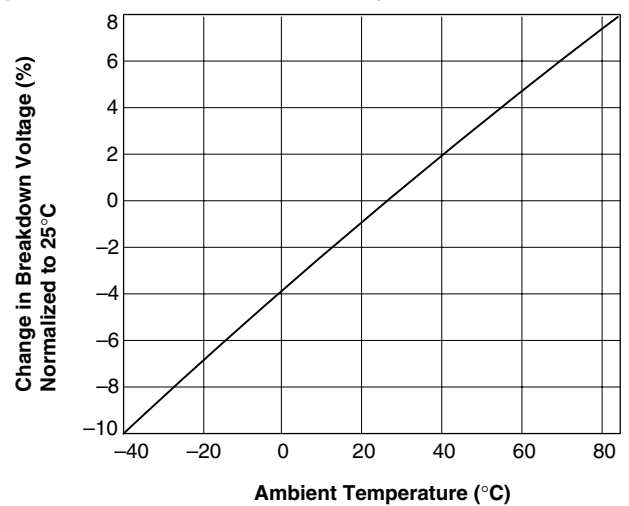

Figure 13. Switch Offset Voltage vs. LED Current

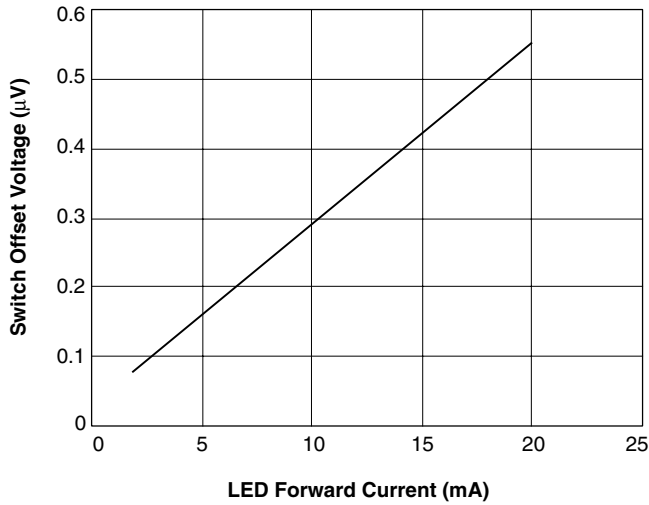

Figure 16. Turn-on Time vs. LED Current

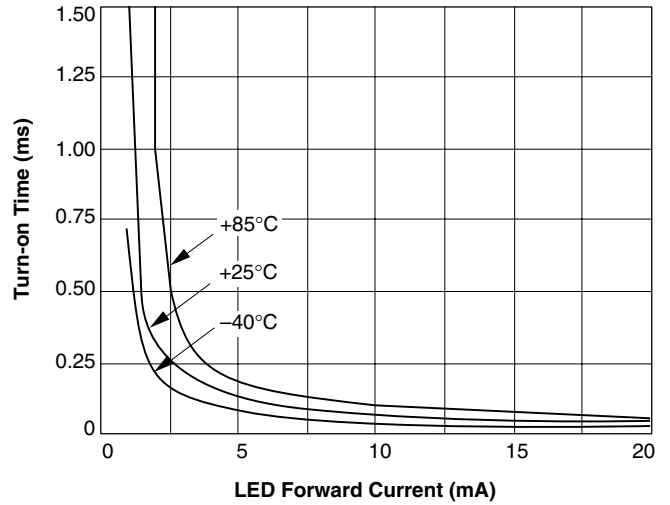

Figure 14. Turn-on Time vs. Temperature

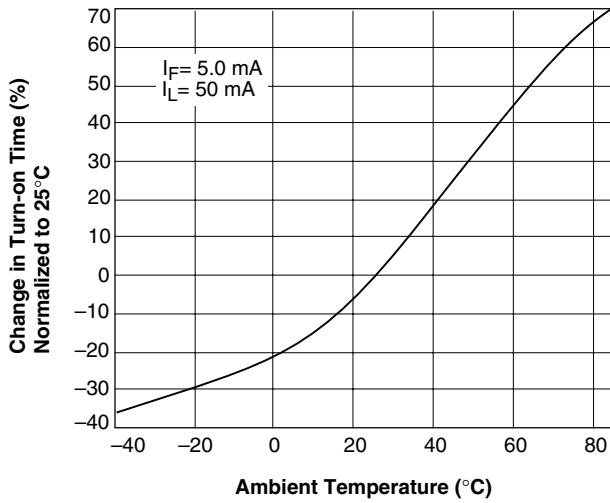

Figure 17. Turn-off Time vs. LED Current

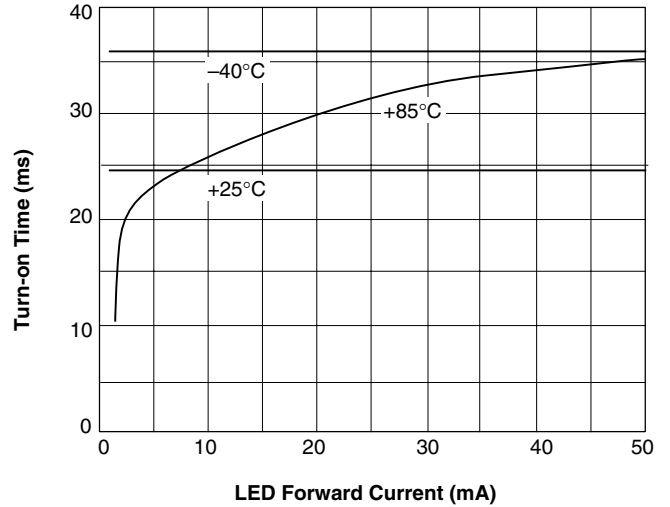

Figure 15. Turn-off Time vs. Temperature

