

LHXX SERIES 5-25W, AC-DC CONVERTER

LH series ---is a compact size power converter offered by Mornsun for PCB mount installation applications. It features universal input voltage, taking both DC and AC input voltage, low power consumption, high efficiency, high reliability, safer isolation. It offers good EMC performance, meets IEC61000, UL60950, EN60601 and IEC60950 standards, and is UL & CE certified, and widely used in industrial, office and civil applications.



RoHS c us E235235

PRODUCT FEATURES

1. Universal Input :85 ~ 264VAC,50/60Hz
2. Regulated output, low ripple and noise
3. efficiency up to 85%
4. compact size, low power consumption, environmentally friendly
5. output short circuit protection, over-current protection and thermal protection
6. UL94V-0; plastic case, meets
7. Class II ,safety grade
8. CE、UL、EN60601 approval
9. EMC and safety standard, meets
10. Three years warranty

MODEL SELECTION

LH10-10B24

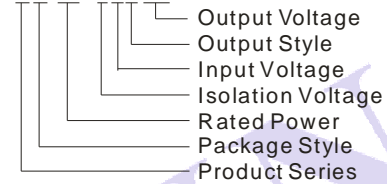

PRODUCT PROGRAM

Approval	Model	Package	Power	Output (Vo1/Io1)	Output (Vo2/Io2)	Ripple and Noise (Typ)	Efficiency (%) (Typ.)	
UL/CE	LH05-10B03	48.5X36X20.5mm	4W	3.3V/1250mA		50mV	70	
UL/CE	LH05-10B05			5V/1000mA			75	
UL/CE	LH05-10B09			9V/550mA			77	
UL/CE	LH05-10B12			12V/420mA			79	
UL/CE	LH05-10B15			15V/330mA			80	
UL/CE	LH05-10B24			24V/230mA			82	
	LH05-10A05		5W	5W	+5V/500mA		-5V/500mA	75
	LH05-10A12				+12V/210mA		-12V/210mA	79
	LH05-10A15				+15V/160mA		-15V/160mA	79
	LH05-10A24				+24V/100mA		-24V/100mA	80
	LH05-10C0505-01				5V/800mA		±5V/100mA	70
	LH05-10C0512-01				5V/600mA		±12V/100mA	73
	LH05-10C0515-01				5V/600mA		±15V/80mA	74
	LH05-10C0524-01				5V/600mA		±24V/50mA	75
	LH05-10D0505-01				5V/900mA		5V/100mA	71
	LH05-10D0512-01				5V/750mA		12V/100mA	73
	LH05-10D0515-01				5V/700mA		15V/100mA	73
	LH05-10D0524-01				5V/600mA		24V/100mA	75
UL/CE	LH10-10B03	55X45X21.0mm	6.6W	3.3V/2000mA		50mV	70	
UL/CE	LH10-10B05			5V/2000mA			76	
UL/CE	LH10-10B09			9V/1100mA			78	
UL/CE	LH10-10B12			12V/900mA			80	
UL/CE	LH10-10B15			15V/700mA			81	
UL/CE	LH10-10B24			24V/450mA			82	
UL/CE	LH10-10A05		10W	10W	+5V/1000mA		-5V/1000mA	76
UL/CE	LH10-10A12				+12V/450mA		-12V/450mA	80
UL/CE	LH10-10A15				+15V/350mA		-15V/350mA	81
UL/CE	LH10-10A24				+24V/200mA		-24V/200mA	84
	LH10-10C0512-02				5V/1000mA		±12V/200mA	75
	LH10-10C0515-02				5V/900mA		±15V/200mA	75
UL/CE	LH10-10D0505-02				5V/1800mA		5V/200mA	75
UL/CE	LH10-10D0512-02				5V/1500mA		12V/200mA	79
UL/CE	LH10-10D0515-02				5V/1400mA		15V/200mA	79
UL/CE	LH10-10D0524-02				5V/1000mA		24V/200mA	81

Approval	Model	Package	Power	Output (Vo1/Io1)	Output (Vo2/Io2)	Ripple and Noise (Typ)	Efficiency (%) (Typ.)				
UL/CE	LH15-10B03	62x45x22.5mm	9.9W	3.3V/3000mA		50mV	73				
UL/CE	LH15-10B05			5V/2800mA			76				
UL/CE	LH15-10B09			9V/1600mA			78				
UL/CE	LH15-10B12			12V/1250mA			80				
UL/CE	LH15-10B15			15V/1000mA			80				
UL/CE	LH15-10B24			24V/625mA			84				
UL/CE	LH15-10B48			48V/320mA			85				
	LH15-10A05		15W		+5V/1500mA		-5V/1500mA	76			
	LH15-10A12				+12V/650mA		-12V/650mA	81			
	LH15-10A15				+15V/500mA		-15V/500mA	83			
	LH15-10C0505-05				5V/2000mA		±5V/500mA	75			
	LH15-10C0512-02				5V/2000mA		±12V/200mA	77			
	LH15-10C0515-02				5V/1800mA		±15V/200mA	78			
	LH15-10C0524-01				5V/2000mA		±24V/100mA	78			
	LH15-10D0505-08				5V/2200mA		5V/800mA	76			
	LH15-10D0512-04				5V/2000mA		12V/400mA	80			
	LH15-10D0515-03				5V/2000mA		15V/300mA	80			
	LH15-10D0524-02				5V/2000mA		24V/200mA	81			
UL/CE	LH20-10B03				70x48x23.5mm		20W	3.3V/4100mA		50mV	73
UL/CE	LH20-10B05							5V/3500mA			75
UL/CE	LH20-10B09	9V/2100mA		77							
UL/CE	LH20-10B12	12V/1600mA		81							
UL/CE	LH20-10B15	15V/1300mA		83							
UL/CE	LH20-10B24	24V/850mA		85							
	LH20-10A05	+5V/2000mA	-5V/2000mA	75							
	LH20-10A12	+12V/830mA	-12V/830mA	82							
	LH20-10A15	+15V/650mA	-15V/650mA	83							
	LH20-10C0512-04	5V/2000mA	±12V/400mA	75							
	LH20-10C0515-03	5V/2000mA	±15V/300mA	76							
	LH20-10C0524-02	5V/2000mA	±24V/200mA	77							
	LH20-10D0512-06	5V/2500mA	12V/600mA	75							
	LH20-10D0524-03	5V/2500mA	24V/300mA	77							
UL/CE	LH25-10B05	70x48x23.5mm	25W	5V/4100mA				50mV	74		
UL/CE	LH25-10B09			9V/2500mA					78		
UL/CE	LH25-10B12			12V/2100mA					82		
UL/CE	LH25-10B15			15V/1600mA		83					
UL/CE	LH25-10B24			24V/1100mA		85					
UL/CE	LH25-10B48			48V/500mA		87					

Remarks :

1. Ripple and Noise are measured by the method of parallel lines;
2. Unless otherwise specified, all specifications above are measured at rated input voltage and rated output load, Ta=25oC, humidity < 75%;
3. All specifications stated in this datasheet are subject to the above listed models only. For specifications of non-standard models, please contact our technical support team.

INPUT SPECIFICATIONS

Input voltage range		85 ~ 264VAC, 120 ~ 370VDC	
Input frequency		47 ~ 63Hz	
Input current	LH05 models LH10 models LH15 models LH20 models LH25 models	110VAC 120mA , typ 230mA , typ 250mA , typ 330mA , typ 420mA , typ	230VAC 70mA , typ 120mA , typ 140mA , typ 180mA , typ 230mA , typ
Inrush current	LH05 models LH10 models LH15 models LH20/LH25 models	110VAC 10A, typ 10A, typ 10A, typ 16A, typ	230VAC 20A, typ 20A, typ 20A, typ 30A, typ
Leakage current		0.3mA RMS typ. 230VAC/50Hz	

External input fuse(recommended)	LH05 models LH10/LH15 models LH20/LH25 models	1A/250V slow blow 2A/250V slow blow 3.15A/250V slow blow
----------------------------------	---	--

OUTPUT SPECIFICATIONS

Voltage set accuracy		±2% (main output)
Input variation		±0.5% (main output) ±1.5% (supplement output)
Load variation (10-100%)	Single output models Dual output models (balanced load) Isolated triple output (balanced load) Isolated and separated twin output (balanced load)	±1% ±2% Vo1: ±3% (main output) ±Vo2: ±5% (supplement output) Vo1: ±3% (main output) Vo2: ±5% (supplement output)
Minimum load	single output models Dual output models Isolated and separated twin output Isolated triple output	0% 10% (main output) 10% (main output) 10% (main output)
Ripple & noise(p-p) (main output)	(20MHz Bandwidth)	50mV (Typ) 100mV (Max)
Short circuit protection		Continuous, and auto resume
Over current protection		≥110% Io
Output over-voltage protection	3.3 / 5VDC models 9VDC models 12 / 15VDC models 24VDC models 48VDC models	≤7.5VDC ≤12VDC ≤20VDC ≤30VDC ≤60VDC

COMMON SPECIFICATIONS

Temperature ranges	Operating temperature : Power derating above 55°C: LH20-10B05 above 50°C: Storage temperature: Case temperature:	-40°C ~ +70 °C 3.75% / °C 2.25% / °C -40°C ~ +105 °C +90°C (max)
Hold-up time	(Vin=230VAC)	80ms (typ)
Humidity (non condensing)		85% (max)
Temperature coefficient		0.02%/°C (main output) 0.15%/°C (supplement output)
Switching frequency		65kHz(typ.)
I/O-isolation voltage		3000VAC/1Min
EMI/RFI conducted		EN55022, level B
EMC compliance	Electrostatic discharge ESD RF field susceptibility Electrical fast transients/bursts on mainsline Surge	IEC/EN 61000-4-2 level 3 6kV/8kV perf. Criteria B IEC/EN 61000-4-3 level 3 10V/m perf. Criteria A IEC/EN 61000-4-4 level 3 2 kV perf. Criteria B IEC/EN 61000-4-5 level 3 1kV/2kV perf. Criteria B
Safety standards		IEC60950,EN60950,UL60950
Safety approvals		EN60950, IEC60950,UL60950
Safety Class		CLASS II
Case material		UL 94V-0
Install		PCB
MTBF		>300,000h @25°C
Package	LH05 models LH10 models LH15 models LH20/LH25 models	48.5x36x20.5mm 55x45x21mm 62x45x22.5mm 70x48x23.5mm

TYPICAL APPLICATIONS

LH**-10B**(Single Output)

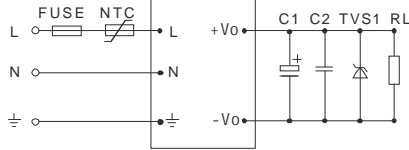

LH**-10D**(Isolate Twin Output)

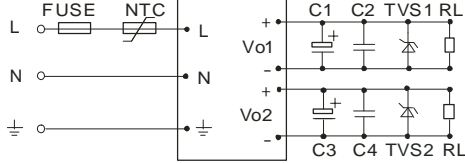

LH05-25 series if higher requirement to EMC application circuit (external circuit output as above typical applications):

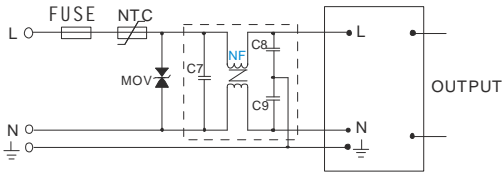

LH**-10A**(Dual Output)

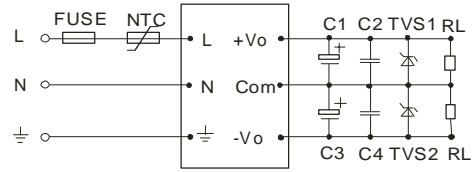

LH**-10C**(Triple Output)

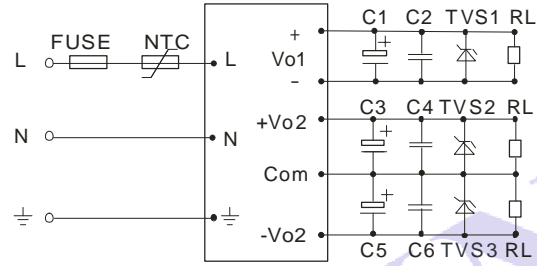

EXTERNAL CAPACITORS TYPICAL VALUE(Unit: μF)

MODEL	C1	C3	C5	MODEL	C1	C3	C5
LH05-10B03	330			LH15-10B03	680		
LH05-10B05	330			LH15-10B05	680		
LH05-10B09	120			LH15-10B09	470		
LH05-10B12	120			LH15-10B12	220		
LH05-10B15	68			LH15-10B15	220		
LH05-10B24	68			LH15-10B24	68		
				LH15-10B48	33		
LH05-10A05	120	120		LH15-10A05	470	470	
LH05-10A12	68	68		LH15-10A12	220	220	
LH05-10A15	47	47		LH15-10A15	120	120	
LH05-10A24	10	10		LH15-10C0505-05	470	220	220
LH05-10C0505-01	220	22	22	LH15-10C0512-02	470	120	120
LH05-10C0512-01	120	22	22	LH15-10C0515-02	470	120	120
LH05-10C0515-01	120	22	22	LH15-10C0524-01	470	120	120
LH05-10C0524-01	120	22	22	LH15-10D0505-08	470	470	
LH05-10D0505-01	220	22		LH15-10D0512-04	470	220	
LH05-10D0512-01	220	22		LH15-10D0515-03	470	120	
LH05-10D0515-01	120	22		LH15-10D0524-02	470	47	
LH05-10D0524-01	120	22					
				LH20-10B03	330		
LH10-10B03	470			LH20-10B05	330		
LH10-10B05	330			LH20-10B09	220		
LH10-10B09	120			LH20-10B12	220		
LH10-10B12	120			LH20-10B15	220		
LH10-10B15	120			LH20-10B24	220		
LH10-10B24	68			LH20-10A05	470	470	
LH10-10A05	220	220		LH20-10A12	120	120	
LH10-10A12	120	120		LH20-10A15	68	68	
LH10-10A15	47	47		LH20-10C0512-04	330	120	120
LH10-10A24	33	33		LH20-10C0515-03	330	120	120
				LH20-10C0524-02	330	47	47
LH10-10C0512-02	220	68	68	LH20-10D0512-06	330	220	
LH10-10C0515-02	220	47	47	LH20-10D0524-03	330	120	
LH10-10D0505-02	220	68					
LH10-10D0512-02	220	68		LH25-10B05	330		
LH10-10D0515-02	220	47		LH25-10B09	330		
LH10-10D0524-02	220	47		LH25-10B12	330		
				LH25-10B15	330		
				LH25-10B24	120		
				LH25-10B48	68		

Remark:

- Output filtering capacitors C1, C2 and C3 are electrolytic capacitors. It is recommended to use high frequency and low impedance electrolytic capacitors. For capacitance and current of capacitor please refer to manufacture's datasheet. Voltage derating of capacitor should be 80% or above. C2,C4,C6 are use to filter high frequency noise, suggest choose 0.1μF. TVS is recommended component to protect post-circuits (if converter fails).
- External input NTC is recommended to use 5D-9 (Only LH10 models and LH15 models)
- if higher requirement to EMC performance, recommended to add"EMC filter" at the input end, recommended parameter as follows:
 MOV: Varistor, model: 471KD10, it is used to protect the device under surge.
 C7:X capacitor, recommended parameter 0.1μF/275V;
 C8,C9:Y capacitor, recommended parameter 2200pF/400V;
 NF: common model choke, recommended inductance is about 10mH-30mH.

TYPICAL EFFICIENCY CURVE

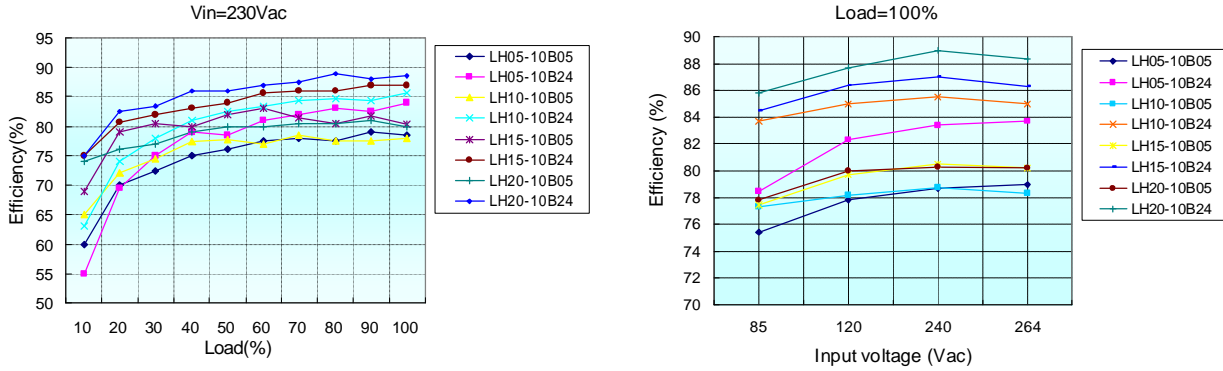

INPUT VOLTAGE VS LOAD

TEMPERATURE VS LOAD

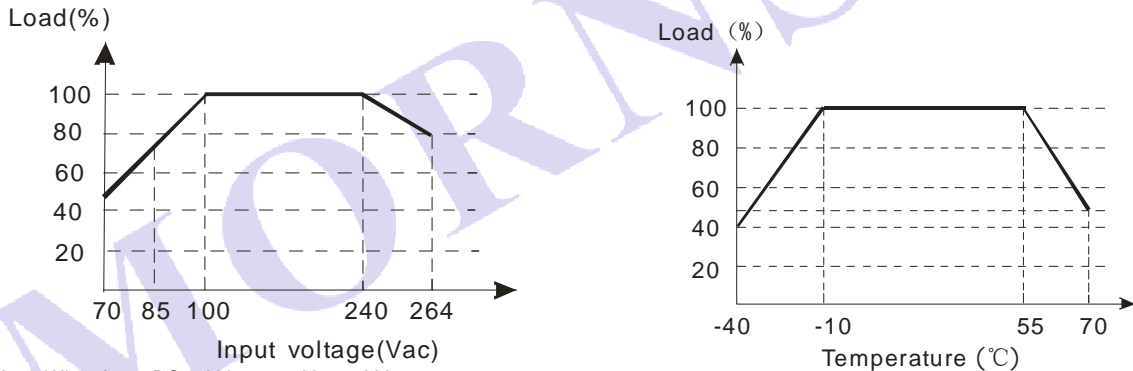

*Note: When input DC, Vdc=1.414Vac-20Vdc.

PARALLEL LINES MEASURE

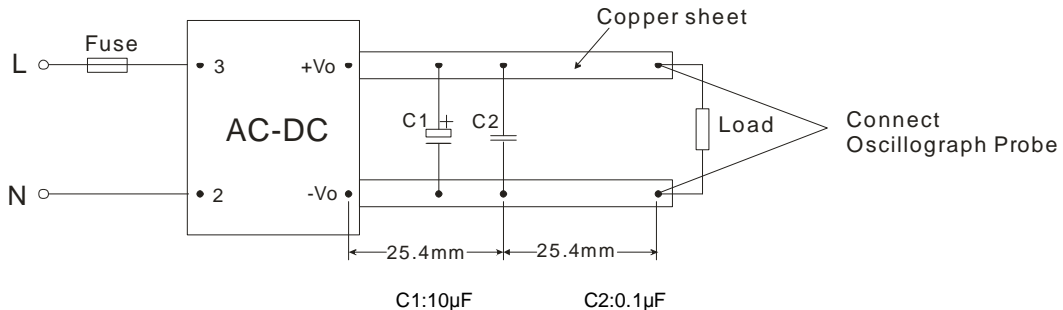

TRIM APPLICATION & TRIM CALCULATION

Application circuit for TRIM
(Part in broken line is the interior of models)

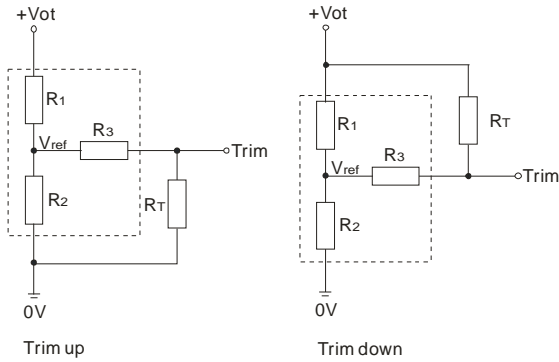

Formula for resistance of Trim

$$\text{up: } R_T = \frac{aR_2}{R_2 - a} - R_3 \quad a = \frac{V_{ref}}{V_{ot} - V_{ref}} \cdot R_1$$

$$\text{down: } R_T = \frac{aR_1}{R_1 - a} - R_3 \quad a = \frac{V_{ot} - V_{ref}}{V_{ref}} \cdot R_2$$

Note: Value for R1, R2, R3, and Vref refer to the following table.

R_T: Resistance of Trim

a: User-defined parameter, no actual meanings.

Vo(V)	3.3	5	12	15	24	48
Resistance						
R1(KΩ)	2	3.3	3.8	7.5	8.6	1.2
R2(KΩ)	1.2	3.3	1	1.5	1	22
R3(KΩ)	1	1	1	1	1	1.2
Vref(V)	1.24	2.5	2.5	2.5	2.5	2.5
Vot(V)	Output voltage of Trim, variation ≤ ±10%					

OUTLINE AND DIMENSIONS

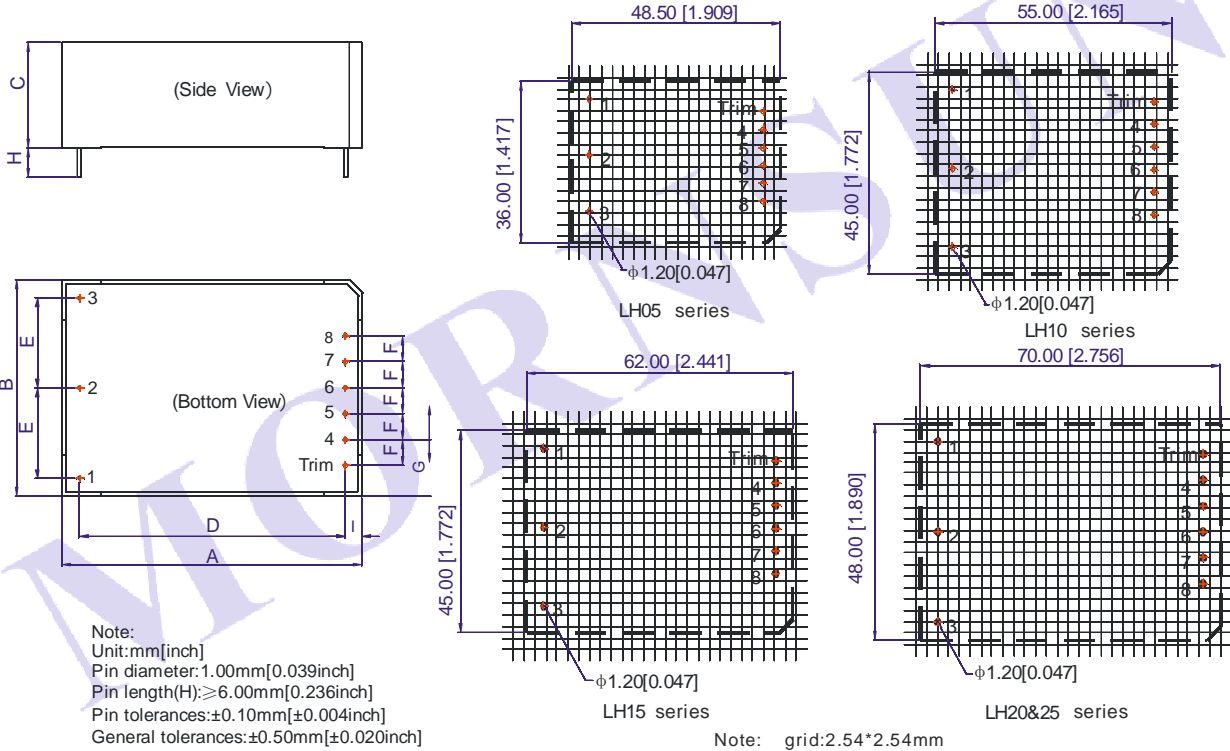

OUTLINE AND DIMENSIONS (Unit: mm)					
NO.	LH05	LH10	LH15	LH20	LH25
A	48.50	55.00	62.00	70.00	70.00
B	36.00	45.00	45.00	48.00	48.00
C	20.50	21.00	22.50	23.50	23.50
D	40.50	47.00	54.00	62.00	62.00
E	12.50	17.50	17.50	20.00	20.00
F	4.00	5.00	5.00	5.75	5.75
G	10.00	12.50	12.50	12.50	12.50
I	4.00	4.00	4.00	4.00	4.00

FOOTPRINT DETAILS				
Pin	LHXX-10B	LHXX-10A	LHXX-10C	LHXX-10D
1				
2	AC(N)	AC(N)	AC(N)	AC(N)
3	AC(L)	AC(L)	AC(L)	AC(L)
4	-Vo	-Vo	-Vo1	-Vo1
5	No Pin	No Pin	+Vo1	+Vo1
6	No Pin	COM	-Vo2	No Pin
7	No Pin	No Pin	COM	-Vo2
8	+Vo	+Vo	+Vo2	+Vo2
Trim	Trim**	No Pin	No Pin	No Pin

There is no pin "1" on LH15-10BXX
Trim**: only for LH20/25-10BXX Series.

MODLES WEIGHT					
WEIGHT	LH05	LH10	LH15	LH20	LH25
(Typ.)	50g	70g	80g	120g	120g

PACKAGE DIAGRAM

(LH05 Series)



(Other Series)

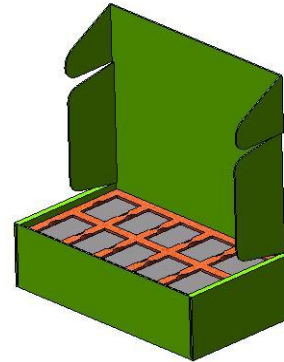

Inner packaging box dimensions: L*W*H=355*192*93mm
 Outer packaging box dimensions: L*W*H=405*380*305mm

Packaging quantity: 20pcs (LH05 series: 40pcs)
 Packaging quantity: 120pcs (LH05 series: 240pcs)

MORNSUN Science & Technology Co.,Ltd.

Address: No. 5, Kehui St. 1, Kehui development center, Science Ave., Guangzhou Science City, Luogang district, Guangzhou,P.R.China.

Tel: 86-20-28203030

Fax:86-20-28203068

[Http://www.mornsun-power.com](http://www.mornsun-power.com)