



LIGITEK

LIGITEK ELECTRONICS CO.,LTD.
Property of Ligitek Only

RECTANGLE TYPE LED LAMPS



Lead-Free Parts

LH85643-PF

DATA SHEET

DOC. NO : QW0905-LH85643-PF

REV. : A

DATE : 31 - Jan. - 2007



Package Dimensions

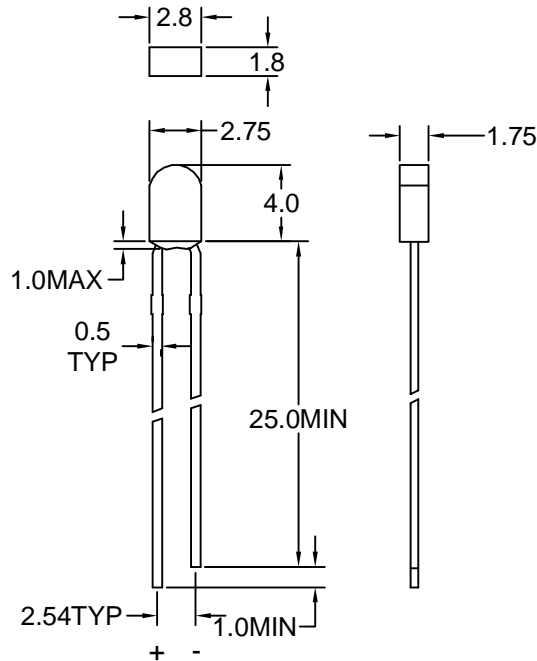

Note : 1.All dimension are in millimeter tolerance is $\pm 0.25\text{mm}$ unless otherwise noted.
2.Specifications are subject to change without notice.

Directivity Radiation

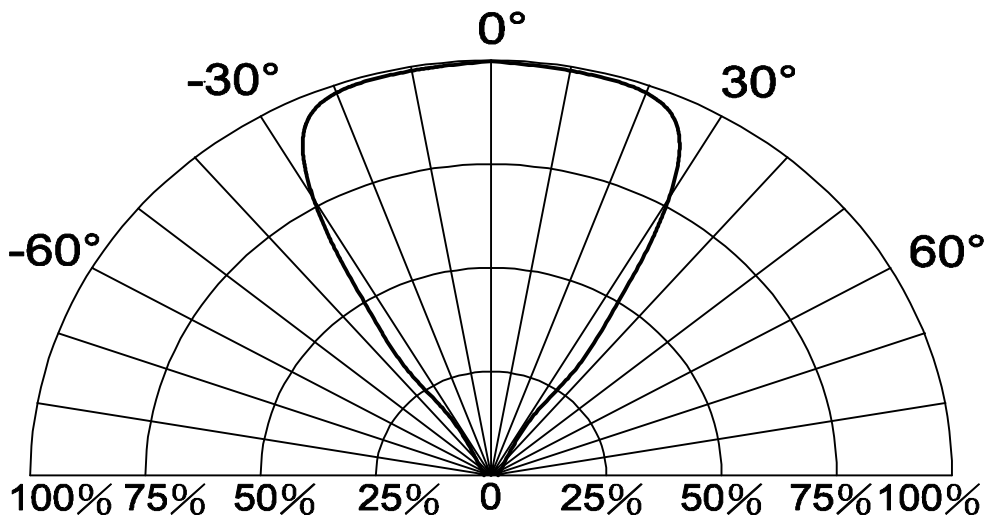

**Absolute Maximum Ratings at Ta=25 °C**

Parameter	Symbol	Ratings	UNIT
		H	
Forward Current	IF	15	mA
Peak Forward Current Duty 1/10@10KHz	IFP	60	mA
Power Dissipation	PD	40	mW
Reverse Current @5V	Ir	10	μA
Operating Temperature	Topr	-40 ~ +85	°C
Storage Temperature	Tstg	-40 ~ +100	°C

Typical Electrical & Optical Characteristics (Ta=25 °C)

PART NO	MATERIAL	COLOR		Peak wave length λ Pnm	Spectral halfwidth Δ λ nm	Forward voltage @20mA(V)		Luminous intensity @10mA(mcd)		Viewing angle 2θ 1/2 (deg)
		Emitted	Lens			Min.	Max.	Min.	Typ.	
LH85643-PF	GaP	Red	Water Clear	697	90	1.7	2.6	3.0	4.5	70

Note : 1. The forward voltage data did not including ±0.1V testing tolerance.
2. The luminous intensity data did not including ±15% testing tolerance.



Typical Electro-Optical Characteristics Curve

H CHIP

Fig.1 Forward current vs. Forward Voltage

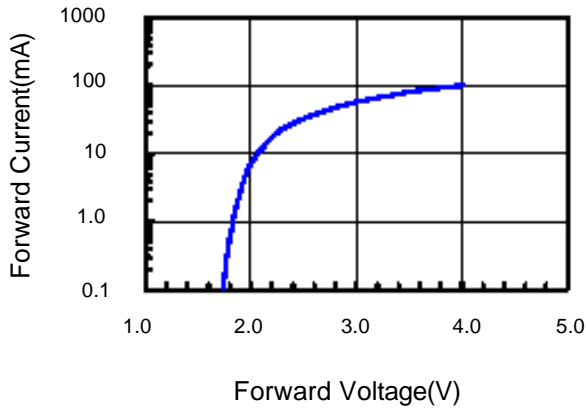

Fig.2 Relative Intensity vs. Forward Current

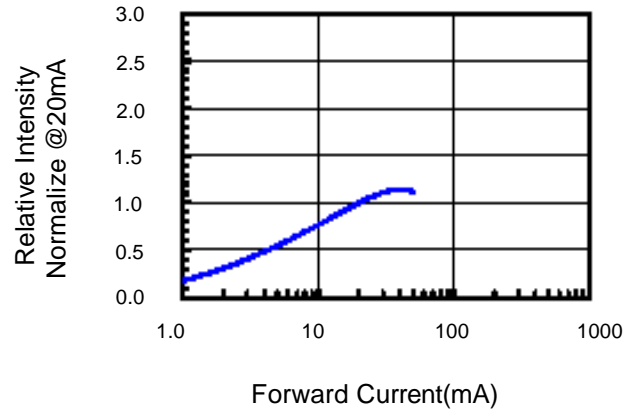

Fig.3 Forward Voltage vs. Temperature

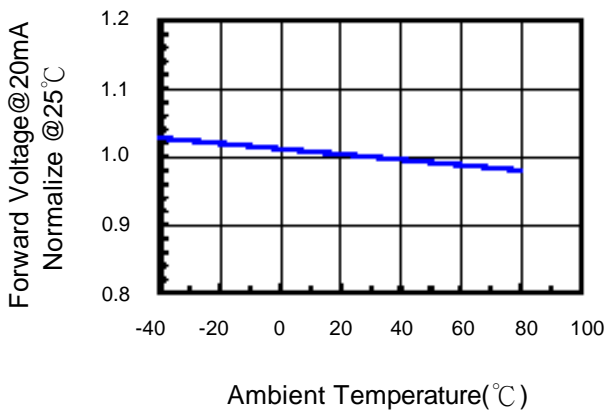

Fig.4 Relative Intensity vs. Temperature

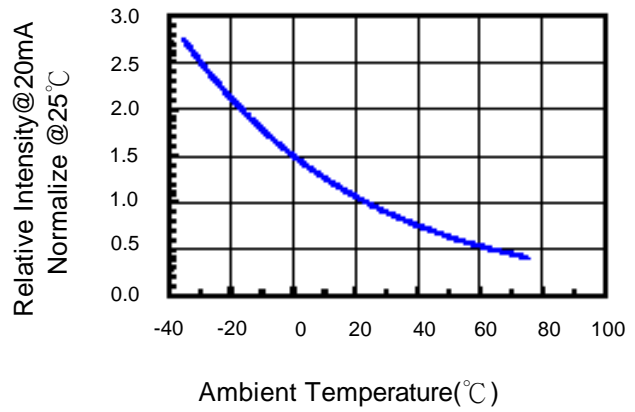
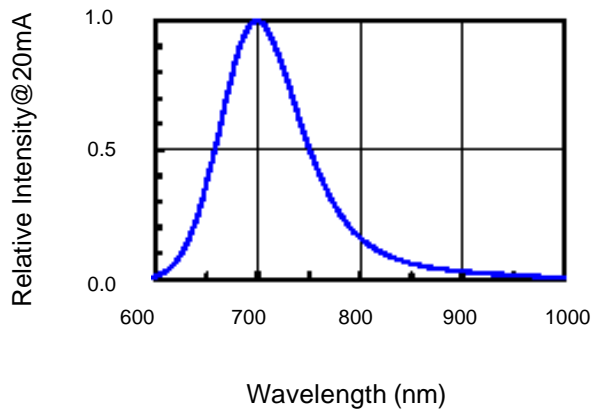

Fig.5 Relative Intensity vs. Wavelength





Soldering Condition(Pb-Free)

1.Iron:

- Soldering Iron:30W Max
- Temperature 350° C Max
- Soldering Time:3 Seconds Max(One time only)
- Distance:2mm Min(From solder joint to body)

2.Wave Soldering Profile

- Dip Soldering
- Preheat: 120° C Max
- Preheat time: 60seconds Max
- Ramp-up
- 2° C/sec(max)
- Ramp-Down:-5° C/sec(max)
- Solder Bath:260° C Max
- Dipping Time:3 seconds Max
- Distance:2mm Min(From solder joint to body)

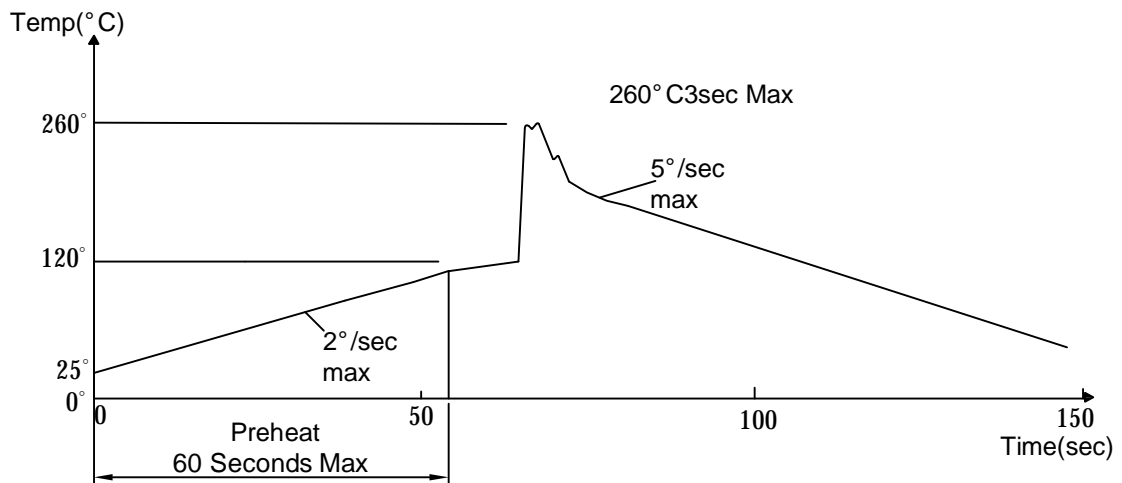

- Note: 1.Wave solder should not be made more than one time.
2.You can just only select one of the soldering conditions as above.



Reliability Test:

Test Item	Test Condition	Description	Reference Standard
Operating Life Test	1.Under Room Temperature 2.If=20mA 3.t=1000 hrs (-24hrs, +72hrs)	This test is conducted for the purpose of determining the resistance of a part in electrical and thermal stressed.	MIL-STD-750: 1026 MIL-STD-883: 1005 JIS C 7021: B-1
High Temperature Storage Test	1.Ta=105 °C ±5°C 2.t=1000 hrs (-24hrs, +72hrs)	The purpose of this is the resistance of the device which is laid under condition of high temperature for hours.	MIL-STD-883:1008 JIS C 7021: B-10
Low Temperature Storage Test	1.Ta=-40 °C ±5°C 2.t=1000 hrs (-24hrs, +72hrs)	The purpose of this is the resistance of the device which is laid under condition of low temperature for hours.	JIS C 7021: B-12
High Temperature High Humidity Test	1.Ta=65 °C ±5°C 2.RH=90%~95% 3.t=240hrs ±2hrs	The purpose of this test is the resistance of the device under tropical for hours.	MIL-STD-202:103B JIS C 7021: B-11
Thermal Shock Test	1.Ta=105 °C ±5°C & -40 °C ±5°C (10min) (10min) 2.total 10 cycles	The purpose of this is the resistance of the device to sudden extreme changes in high and low temperature.	MIL-STD-202: 107D MIL-STD-750: 1051 MIL-STD-883: 1011
Solder Resistance Test	1.T.Sol=260 °C ±5°C 2.Dwell time= 10 ±1sec.	This test intended to determine the thermal characteristic resistance of the device to sudden exposures at extreme changes in temperature when soldering the lead wire.	MIL-STD-202: 210A MIL-STD-750: 2031 JIS C 7021: A-1
Solderability Test	1.T.Sol=230 °C ±5°C 2.Dwell time=5 ±1sec	This test intended to see soldering well performed or not.	MIL-STD-202: 208D MIL-STD-750: 2026 MIL-STD-883: 2003 JIS C 7021: A-2