

# ラジアルリードインダクタ

## RADIAL LEADED INDUCTORS

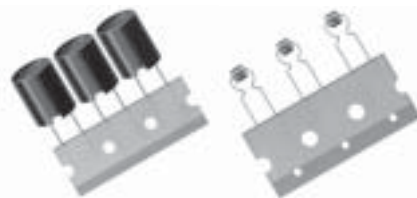

フロー/WAVE

OPERATING TEMP.	-25~+105℃(製品自己発熱含む) (Including self-generated heat)
-----------------	--

### 特長 FEATURES

- LHL08~LHL16シリーズはケース(LHF□□□BBはベース)タイプであるので、基板上での自立安定性に優れる
- 小電流用にはLAV35/LHL06が対応
- 大電流用にはLHLC06/LHLZ06/LHL08/LHL10/LHL13/LHL16/LHF□□□BBが対応
- LHF□□□BB以外は自動挿入対応
- LHFP13/15BBは大電流用の磁気シールドタイプ
- The LHL08~LHL16 series radial inductors are encapsulated in a resin housing which adds to the stability of the mounted part on a printed circuit board.
- The LAV35 and LHL06 series are for small current applications.
- The LHLC06/LHLZ06/LHL08/LHL10/LHL13/LHL16/LHF□□□BB series are for high current applications.
- All items can be packaged for automatic insertion except the LHF□□□BB type.
- The LHFP13/15BB series are shielded type for high current applications.

### 用途 APPLICATIONS

- 一般民生(テレビ、ビデオ等の家電)、産機用機器の電源用チョークコイル
- 各種フィルタ用ピーキングコイル
- Ideal for use as a power choke coil in general household appliances (TV sets, video appliances, etc.) and industrial equipment
- Can also be used as a peaking coil in filtering applications

### 形名表記法 ORDERING CODE

<b>1</b>	<b>3</b>	<b>4</b>	<b>5</b>	<b>6</b>
<b>形式</b>	<b>外形寸法 (mm 以下)</b>	<b>包装</b>	<b>公称インダクタンス [μH]</b>	<b>インダクタンス許容差[%]</b>
LA アキシアルインダクタ	06 L06 6.8, LC06 7.5, LZ06 7.8	BB 単品 (LHF)	例	J ±5
LH ラジアルインダクタ	08 9.0	NB 単品 (LHL)	1R0 1.0	K ±10
	10 11.0	TB つづら折りテーピング (LHL)	150 15	M ±20
	13 LHL 14.0, LHFP 14.5	VB つづら折りテーピング (LAV)	102 1000	N ±30
	15 LHF 18.0, LHFP 16.0		※R= 小数点	
	16 17.0			
	35 6.0(LAV)			
<b>2</b>				<b>7</b>
<b>形状記号</b>				<b>当社管理記号</b>
F△ 単品のみ				△△△ 標準品
FP 磁気シールドタイプ単品				△=スペース
L△ テーピング対応品				
LC 大電流タイプ				
LZ 大電流、低RDCタイプ				
V△ ラジアルフォーミング				
△=スペース				



<b>1</b>	<b>3</b>	<b>4</b>	<b>5</b>	<b>6</b>
<b>Type</b>	<b>External dimensions(mm max)</b>	<b>Packaging Code</b>	<b>Nominal Inductance(μH)</b>	<b>Inductance Tolerances (%)</b>
LA Axial inductor	06 L06 6.8, LC06 7.5, LZ06 7.8	BB Bulk(LHF)	example	J ±5
LH Radial inductor	08 9.0	NB Bulk(LHL)	1R0 1.0	K ±10
	10 11.0	TB Ammo packaging (LHL)	150 15	M ±20
	13 14.0	VB Ammo packaging (LAV)	102 1000	N ±30
	15 18.0		※R=Decimal point	
	16 17.0			
	35 6.0(LAV)			
<b>2</b>				<b>7</b>
<b>Configuration</b>				<b>Internal code</b>
F△ Bulk only				△△△ Standard product
FP Shielded type Bulk only				△=Blank space
L△ Standard type Taping available				
LC High current type				
LZ High current, low RDC type				
V△ Radial formed lead				
△=Blank space				

# 外形寸法 EXTERNAL DIMENSIONS

Type	LAV35	LHL06	LHLC06	LHLZ06	LHL08	LHL10	LHL13	LHL16	LHF15BB	LHFP13BB	LHFP15BB
Fig.											
D	6.0max (0.236max)	6.8max (0.268max)	7.5max (0.295max)	7.8max (0.307max)	9.0max (0.354max)	11.0max (0.433max)	14.0max (0.551max)	17.0max (0.669max)	18.0max (0.709max)	14.5max (0.571max)	16.0max (0.630max)
H <sub>2</sub>	8.0max (0.315max)	11.0max (0.433max)	11.0max (0.433max)	11.0max (0.433max)	9.5max (0.374max)	14.0max (0.551max)	17.0max (0.669max)	21.0max (0.827max)	23.0max (0.906max)	20.0max (0.788max)	23.0max (0.906max)
l	—	5.0±1.0 (0.197±0.039)	5.0±1.0 (0.197±0.039)	5.0±1.0 (0.197±0.039)	5.0±1.0 (0.197±0.039)	5.0±1.0 (0.197±0.039)	5.0±1.0 (0.197±0.039)	5.0±1.0 (0.197±0.039)	5.0±1.0 (0.197±0.039)	5.0±1.0 (0.197±0.039)	5.0±1.0 (0.197±0.039)
F	—	5.0±1.0 (0.197±0.039)	5.0±1.0 (0.197±0.039)	5.0±1.0 (0.197±0.039)	5.0±1.0 (0.197±0.039)	5.0±1.0 (0.197±0.039)	7.5±1.0 (0.295±0.039)	7.5±1.0 (0.295±0.039)	10.0±1.0 (0.394±0.039)	7.5±1.0 (0.295±0.039)	7.5±1.0 (0.295±0.039)
φd	0.5±0.05 (0.020±0.002)	0.6±0.05 (0.024±0.002)	0.6±0.05 (0.024±0.002)	0.6±0.05 (0.024±0.002)	0.6±0.05 (0.024±0.002)	0.6±0.05 (0.024±0.002)	0.8±0.05 (0.031±0.002)	0.8±0.05 (0.031±0.002)	1.0±0.05 (0.039±0.002)	0.8±0.05 (0.031±0.002)	0.8±0.05 (0.031±0.002)

Unit : mm(inch)

# 概略バリエーション AVAILABLE INDUCTANCE RANGE

Type Range	LAV35	LHL06	LHLC06	LHLZ06	LHL08	LHL10	LHL13	LHL16	LHF15BB	LHFP13BB	LHFP15BB
	Inductance [H]	0.22μ 1.0μ 1.0m	1.0μ 10m	1.0μ 100μ	1.0μ 1.0m	1.0μ 33m	3.3μ 150m	10μ 10m	47μ 10m	47μ 10m	10μ 10m

代 表 値 Examples	Inductance [H]	LAV35	LHL06	LHLC06	LHLZ06	LHL08	LHL10	LHL13	LHL16	LHF15BB	LHFP13BB	LHFP15BB										
		直流抵抗 DC Resistance [Ω]	定格電流 Rated current [A]	直流抵抗 DC Resistance [Ω]	定格電流 Rated current [A]	直流抵抗 DC Resistance [Ω]	定格電流 Rated current [A]	直流抵抗 DC Resistance [Ω]	定格電流 Rated current [A]	直流抵抗 DC Resistance [Ω]	定格電流 Rated current [A]	直流抵抗 DC Resistance [Ω]	定格電流 Rated current [A]									
	max.	max.	max.	max.	max.	max.	max.	max.	max.	max.	max.	max.										
	max.	max.	max.	max.	max.	max.	max.	max.	max.	max.	max.	max.										
1.0μ	0.17	0.79	0.15	0.75	0.049	2.5	0.026	3.4	0.013	4.7	—	—										
10μ	0.45	0.46	0.47	0.41	0.19	1.2	0.10	1.7	0.041	2.4	0.034	3.2	0.023	4.5	—	—	—	—	0.024	4.4	—	—
100μ	3.3	0.15	1.4	0.21	0.92	0.42	0.77	0.57	0.32	0.79	0.18	1.2	0.12	2.0	0.077	2.9	0.095	2.9	0.15	1.6	0.078	2.5
1.0m	28.0	0.055	10.0	0.065	—	—	9.5	0.16	2.7	0.25	1.8	0.41	1.2	0.60	0.74	0.86	0.67	0.95	1.4	0.50	0.94	0.72
10m	—	—	96.0	0.022	—	—	—	—	32.0	0.070	19.0	0.12	10.0	0.19	7.3	0.25	6.6	0.25	12	0.16	8.3	0.22
100m	—	—	—	—	—	—	—	—	—	—	240.0	0.031	—	—	—	—	—	—	—	—	—	—

セレクションガイド  
Selection Guide

アイテム一覧  
Part Numbers

特性図  
Electrical Characteristics

梱包  
Packaging

信頼性  
Reliability Data

使用上の注意  
Precautions



etc

LAV35

形名 Ordering code	公称 インダクタンス Inductance [μH]	インダクタンス 許容差 Inductance Tolerance [%]	Q (min.)	自己共振 周波数 Self-resonant frequency [MHz] (min.)	直流抵抗 DC Resistance [Ω] (max.)	定格電流 Rated current [mA] (max.)	測定 周波数 Measuring frequency [MHz]	
LAV35VBR22M	0.22	±20%	50.0	170.0	0.09	1000.0	25.2	
LAV35VBR27M	0.27			160.0	0.10	980.0		
LAV35VBR33M	0.33			140.0	0.11	960.0		
LAV35VBR39M	0.39			130.0	0.12	940.0		
LAV35VBR47M	0.47			120.0	0.13	910.0		
LAV35VBR56M	0.56			110.0	0.14	880.0		
LAV35VBR68M	0.68			100.0	0.15	850.0		
LAV35VBR82M	0.82			90.0	0.16	820.0		
LAV35VB1R0K	1.0	±10%		50.0	82.0	0.17	790.0	7.96
LAV35VB1R2K	1.2				70.0	0.18	760.0	
LAV35VB1R5K	1.5				65.0	0.20	730.0	
LAV35VB1R8K	1.8				57.0	0.22	700.0	
LAV35VB2R2K	2.2				47.0	0.24	670.0	
LAV35VB2R7K	2.7				40.0	0.26	640.0	
LAV35VB3R3K	3.3				35.0	0.28	610.0	
LAV35VB3R9K	3.9				33.0	0.30	580.0	
LAV35VB4R7K	4.7				31.0	0.33	560.0	
LAV35VB5R6K	5.6				27.0	0.36	540.0	
LAV35VB6R8K	6.8				24.0	0.39	520.0	
LAV35VB8R2K	8.2				22.0	0.42	490.0	
LAV35VB100K	10.0				21.0	0.45	460.0	
LAV35VB120K	12.0				18.0	1.2	350.0	
LAV35VB150K	15.0				16.0	1.3	330.0	
LAV35VB180K	18.0				14.0	1.4	300.0	
LAV35VB220K	22.0				13.0	1.5	270.0	
LAV35VB270K	27.0				12.0	1.6	250.0	
LAV35VB330K	33.0	11.0		1.8	235.0			
LAV35VB390K	39.0	10.0		2.0	220.0			
LAV35VB470K	47.0	9.5	2.2	200.0				
LAV35VB560K	56.0	9.0	2.4	190.0				
LAV35VB680K	68.0	8.5	2.8	170.0				
LAV35VB820K	82.0	8.0	3.0	155.0				
LAV35VB101J	100.0	±5%	50.0	7.5	3.3	150.0	0.796	
LAV35VB121J	120.0			6.8	4.2	140.0		
LAV35VB151J	150.0			6.2	5.0	130.0		
LAV35VB181J	180.0			5.6	6.0	125.0		
LAV35VB221J	220.0			5.0	7.5	120.0		
LAV35VB271J	270.0			4.6	11	105.0		
LAV35VB331J	330.0			4.2	13	95.0		
LAV35VB391J	390.0			3.8	15	90.0		
LAV35VB471J	470.0			3.4	17	80.0		
LAV35VB561J	560.0			3.0	19	75.0		
LAV35VB681J	680.0			2.6	22	68.0		
LAV35VB821J	820.0			2.2	25	60.0		
LAV35VB102J	1000.0	2.0	28	55.0				

LHL06

形名 Ordering code	公称 インダクタンス Inductance [μH]	インダクタンス 許容差 Inductance Tolerance	Q (min.)	自己共振 周波数 Self-resonant frequency [MHz] (min.)	直流抵抗 DC Resistance [Ω] (max.)	定格電流 Rated current [mA] (max.)	測定 周波数 Measuring frequency [MHz]
LHL06□1R0M	1.0	±20%	50.0	87.0	0.15	750.0	7.96
LHL06□1R2M	1.2			78.0	0.16	720.0	
LHL06□1R5M	1.5			76.0	0.17	680.0	
LHL06□1R8M	1.8			70.0	0.18	650.0	
LHL06□2R2M	2.2			57.0	0.20	610.0	
LHL06□2R7M	2.7			47.0	0.25	580.0	
LHL06□3R3M	3.3			40.0	0.26	560.0	
LHL06□3R9K	3.9			35.0	0.27	530.0	
LHL06□4R7K	4.7			32.0	0.30	510.0	
LHL06□5R6K	5.6			25.0	0.34	480.0	
LHL06□6R8K	6.8	23.0	0.38	460.0			
LHL06□8R2K	8.2	22.0	0.39	440.0			
LHL06□100K	10.0	18.0	0.47	410.0	2.52		
LHL06□120K	12.0	17.0	0.39	400.0			
LHL06□150K	15.0	16.0	0.46	380.0			
LHL06□180K	18.0	14.0	0.51	360.0			
LHL06□220K	22.0	13.0	0.52	340.0			
LHL06□270K	27.0	11.0	0.62	320.0			
LHL06□330K	33.0	10.0	0.68	300.0			
LHL06□390K	39.0	8.9	0.78	290.0			
LHL06□470K	47.0	8.5	0.85	270.0			
LHL06□560K	56.0	8.2	0.90	250.0			
LHL06□680K	68.0	7.2	1.1	245.0	0.796		
LHL06□820K	82.0	7.0	1.2	230.0			
LHL06□101K	100.0	6.8	1.4	210.0			
LHL06□121K	120.0	6.6	1.5	190.0			
LHL06□151K	150.0	5.8	1.7	170.0			
LHL06□181K	180.0	5.2	2.0	165.0			
LHL06□221K	220.0	4.7	2.3	160.0			
LHL06□271K	270.0	4.6	2.6	130.0			
LHL06□331K	330.0	4.0	3.1	120.0			
LHL06□391K	390.0	3.5	3.9	110.0			
LHL06□471K	470.0	3.4	4.4	100.0	0.252		
LHL06□561K	560.0	3.1	4.8	85.0			
LHL06□681K	680.0	2.9	6.8	80.0			
LHL06□821K	820.0	2.5	7.9	75.0			
LHL06□102J	1000.0	2.4	10.0	65.0			
LHL06□122J	1200.0	2.0	12.0	58.0			
LHL06□152J	1500.0	1.8	17.0	54.0			
LHL06□182J	1800.0	1.7	20.0	51.0			
LHL06□222J	2200.0	1.6	21.0	49.0			
LHL06□272J	2700.0	1.5	26.0	44.0			
LHL06□332J	3300.0	1.3	34.0	37.0	0.0796		
LHL06□392J	3900.0	1.2	38.0	35.0			
LHL06□472J	4700.0	1.1	42.0	33.0			
LHL06□562J	5600.0	1.0	52.0	30.0			
LHL06□682J	6800.0	0.9	74.0	26.0			
LHL06□822J	8200.0	0.8	84.0	24.0			
LHL06□103J	10000.0	40.0	0.7	96.0		22.0	

形名の□には包装記号(TB：テーピング, NB：単品)が入ります。

□ Please specify the packaging code.(TB：Taping, NB：Bulk)

LHLC06

形名 Ordering code	公称 インダクタンス Inductance [μH]	インダクタンス 許容差 Inductance Tolerance	Q (min.)	自己共振 周波数 Self-resonant frequency [MHz] (min.)	直流抵抗 DC Resistance [Ω] (max.)	定格電流 Rated current [A] (max.)	測定 周波数 Measuring frequency [MHz]	
LHLC06□1R0M	1.0	±20%	20.0	98.0	0.049	2.5	7.96	
LHLC06□1R5M	1.5			67.0	0.066	2.1		
LHLC06□2R2M	2.2			58.0	0.074	1.9		
LHLC06□3R3M	3.3			37.0	0.11	1.6		
LHLC06□4R7K	4.7			29.0	0.12	1.4		
LHLC06□6R8K	6.8			24.0	0.14	1.3		
LHLC06□100K	10.0	±10%	30.0	19.0	0.19	1.2	2.52	
LHLC06□120K	12.0			17.0	0.20	1.15		
LHLC06□150K	15.0			15.0	0.23	1.0		
LHLC06□180K	18.0			13.0	0.26	0.95		
LHLC06□220K	22.0			12.0	0.28	0.90		
LHLC06□270K	27.0			11.0	0.33	0.80		
LHLC06□330K	33.0			9.4	0.37	0.73		
LHLC06□390K	39.0		9.3	0.50	0.70			
LHLC06□470K	47.0		9.2	0.57	0.63			
LHLC06□560K	56.0		25.0	8.8	0.63	0.57		
LHLC06□680K	68.0			8.2	0.70	0.53		
LHLC06□820K	82.0			7.6	0.78	0.48		
LHLC06□101K	100.0			6.9	0.92	0.42		0.796

形名の□には包装記号(TB：テーピング, NB：単品)が入ります。

□ Please specify the packaging code.(TB：Taping, NB：Bulk)

LHLZ06

形名 Ordering code	公称 インダクタンス Inductance [μH]	インダクタンス 許容差 Inductance Tolerance	Q (min.)	自己共振 周波数 Self-resonant frequency [MHz] (min.)	直流抵抗 DC Resistance [Ω] (max.)	定格電流 Rated current [A] (max.)	測定 周波数 Measuring frequency [MHz]	
LHLZ06□1R0M	1.0	±20%	20.0	85.0	0.026	3.4	7.96	
LHLZ06□1R5M	1.5			65.0	0.032	3.0		
LHLZ06□2R2M	2.2			50.0	0.039	2.6		
LHLZ06□3R3M	3.3			35.0	0.047	2.3		
LHLZ06□4R7M	4.7			28.0	0.055	2.1		
LHLZ06□6R8M	6.8			23.0	0.070	1.9		
LHLZ06□100K	10.0	±10%	30.0	18.0	0.10	1.7	2.52	
LHLZ06□150K	15.0		14.0	0.14	1.3			
LHLZ06□220K	22.0		20.0	9.5	0.19	1.2		
LHLZ06□330K	33.0			8.2	0.28	0.92		
LHLZ06□470K	47.0			7.7	0.35	0.82		
LHLZ06□680K	68.0			6.9	0.50	0.71		
LHLZ06□101K	100.0			5.6	0.77	0.57		
LHLZ06□151K	150.0			4.2	1.2	0.47		
LHLZ06□221K	220.0			30.0	3.8	2.0		0.36
LHLZ06□331K	330.0		3.1		2.5	0.31		
LHLZ06□471K	470.0		2.4		3.9	0.24		
LHLZ06□681K	680.0		50.0	2.1	5.0	0.21		0.796
LHLZ06□102J	1000.0			1.6	9.5	0.16		

形名の□には包装記号(TB：テーピング, NB：単品)が入ります。

□ Please specify the packaging code.(TB：Taping, NB：Bulk)

LHL08

形名 Ordering code	公称 インダクタンス Inductance [μH]	インダクタンス 許容差 Inductance Tolerance	Q (min.)	自己共振 周波数 Self-resonant frequency [MHz] (min.)	直流抵抗 DC Resistance [Ω] (max.)	定格電流 Rated current [A] (max.)	測定 周波数 Measuring frequency [MHz]	
LHL08□1R0N	1.0	±30%	40.0	76.0	0.013	4.7	7.96	
LHL08□1R5M	1.5	±20%		65.0	0.014	4.4		
LHL08□2R2M	2.2			56.0	0.017	4.1		
LHL08□2R7M	2.7			48.0	0.019	3.5		
LHL08□3R3M	3.3			41.0	0.021	3.2		
LHL08□3R9M	3.9			33.0	0.024	3.1		
LHL08□4R7M	4.7			30.0	0.025	3.0		
LHL08□5R6M	5.6			23.0	0.028	2.9		
LHL08□6R8M	6.8			21.0	0.030	2.8		
LHL08□8R2M	8.2			19.0	0.034	2.5		
LHL08□100K	10.0		±10%	65.0	17.0	0.041	2.4	2.52
LHL08□120K	12.0	50.0		16.0	0.044	2.3		
LHL08□150K	15.0			13.0	0.053	2.0		
LHL08□180K	18.0			12.0	0.060	1.9		
LHL08□220K	22.0			11.0	0.068	1.8		
LHL08□270K	27.0			10.0	0.091	1.5		
LHL08□330K	33.0			40.0	8.8	0.10	1.4	
LHL08□390K	39.0	8.4			0.12	1.3		
LHL08□470K	47.0	8.2			0.15	1.2		
LHL08□560K	56.0	7.9			0.17	1.1		
LHL08□680K	68.0	35.0		7.0	0.20	1.0		
LHL08□820K	82.0			6.5	0.22	0.90		
LHL08□101K	100.0			25.0	5.7	0.32	0.79	0.796
LHL08□121K	120.0			5.2	0.36	0.70		
LHL08□151K	150.0	20.0		4.7	0.41	0.64		
LHL08□181K	180.0	35.0		4.2	0.66	0.60		
LHL08□221K	220.0			3.7	0.73	0.53		
LHL08□271K	270.0	25.0		3.5	0.85	0.51		
LHL08□331K	330.0			3.2	0.97	0.44		
LHL08□391K	390.0	20.0		2.9	1.1	0.41		
LHL08□471K	470.0		2.4	1.3	0.38			
LHL08□561K	560.0	25.0	2.2	1.5	0.35			
LHL08□681K	680.0		2.0	1.8	0.32			
LHL08□821K	820.0	30.0	1.6	2.3	0.30	0.252		
LHL08□102J	1000.0	55.0	1.5	2.7	0.25			
LHL08□122J	1200.0	45.0	1.4	3.2	0.22			
LHL08□152J	1500.0		55.0	1.3	4.1		0.20	
LHL08□182J	1800.0			1.2	4.8		0.19	
LHL08□222J	2200.0			1.1	5.6		0.16	
LHL08□272J	2700.0			1.0	7.5		0.15	
LHL08□332J	3300.0			0.85	8.5		0.14	
LHL08□392J	3900.0			0.78	9.7		0.11	
LHL08□472J	4700.0		65.0	0.68	14.0		0.10	
LHL08□562J	5600.0	0.62		16.0	0.093			
LHL08□682J	6800.0	0.61		18.0	0.092			
LHL08□822J	8200.0	0.60		20.0	0.084			
LHL08□103J	10000.0	60.0	0.48	32.0	0.070	L:1kHz Q:0.0796		
LHL08□123J	12000.0		0.44	36.0	0.064			
LHL08□153J	15000.0		0.35	62.0	0.051			
LHL08□183J	18000.0		0.30	72.0	0.048			
LHL08□223J	22000.0		0.28	82.0	0.044			
LHL08□273J	27000.0		0.25	90.0	0.042			
LHL08□333J	33000.0		0.23	100.0	0.040			

形名の□には包装記号(TB：テーピング, NB：単品)が入ります。

□ Please specify the packaging code.(TB : Taping, NB : Bulk)

LHL10

形名 Ordering code	公称 インダクタンス Inductance [μH]	インダクタンス 許容差 Inductance Tolerance	Q (min.)	自己共振 周波数 Self-resonant frequency [MHz] (min.)	直流抵抗 DC Resistance [Ω] (max.)	定格電流 Rated current [A] (max.)	測定 周波数 Measuring frequency [MHz]		
LHL10□3R3M	3.3	±20%	50.0	46.0	0.019	4.2	7.96		
LHL10□3R9M	3.9			40.0	0.022	4.1			
LHL10□4R7M	4.7			38.0	0.024	4.0			
LHL10□5R6M	5.6			34.0	0.025	3.8			
LHL10□6R8M	6.8			30.0	0.028	3.4			
LHL10□8R2M	8.2			24.0	0.031	3.3			
LHL10□100K	10.0	±10%	90.0	19.0	0.034	3.2	2.52		
LHL10□120K	12.0			16.0	0.038	2.8			
LHL10□150K	15.0			12.0	0.042	2.6			
LHL10□180K	18.0		60.0	9.2	0.046	2.4			
LHL10□220K	22.0			8.6	0.061	2.1			
LHL10□270K	27.0			7.1	0.069	2.0			
LHL10□330K	33.0		50.0	6.8	0.078	1.9			
LHL10□390K	39.0			6.7	0.085	1.8			
LHL10□470K	47.0			6.2	0.093	1.7			
LHL10□560K	56.0		40.0	50.0	5.2	0.10		1.6	0.796
LHL10□680K	68.0				4.9	0.12		1.5	
LHL10□820K	82.0				4.7	0.13		1.4	
LHL10□101K	100.0				3.8	0.18		1.2	
LHL10□121K	120.0				3.2	0.25		1.0	
LHL10□151K	150.0				2.9	0.29		0.95	
LHL10□181K	180.0			2.6	0.40	0.80			
LHL10□221K	220.0			2.3	0.44	0.75			
LHL10□271K	270.0			2.1	0.50	0.70			
LHL10□331K	330.0	30.0		2.0	0.56	0.68			
LHL10□391K	390.0			1.8	0.62	0.63			
LHL10□471K	470.0			1.7	0.84	0.57			
LHL10□561K	560.0		1.5	0.93	0.52				
LHL10□681K	680.0		1.4	1.0	0.48				
LHL10□821K	820.0		1.3	1.4	0.42				
LHL10□102J	1000.0	±5%	50.0	1.2	1.8	0.41	0.252		
LHL10□122J	1200.0			0.87	2.3	0.33			
LHL10□152J	1500.0			0.83	2.7	0.30			
LHL10□182J	1800.0			0.75	3.0	0.29			
LHL10□222J	2200.0			0.70	3.9	0.25			
LHL10□272J	2700.0			0.67	4.3	0.24			
LHL10□332J	3300.0			0.56	5.8	0.21			
LHL10□392J	3900.0			0.54	6.4	0.20			
LHL10□472J	4700.0			0.49	7.1	0.19			
LHL10□562J	5600.0			0.41	9.0	0.17			
LHL10□682J	6800.0			0.38	10.0	0.16			
LHL10□822J	8200.0			0.36	12.0	0.15			
LHL10□103J	10000.0		60.0	40.0	0.29	19.0	0.12	L:1kHz Q:0.0796	
LHL10□123J	12000.0				0.27	21.0	0.11		
LHL10□153J	15000.0				0.24	34.0	0.090		
LHL10□183J	18000.0				0.21	38.0	0.081		
LHL10□223J	22000.0				0.20	43.0	0.075		
LHL10□273J	27000.0				0.15	67.0	0.060		
LHL10□333J	33000.0		30.0	30.0	0.14	76.0	0.056	L:1kHz Q:0.0252	
LHL10□393J	39000.0				0.13	84.0	0.053		
LHL10□473J	47000.0				0.12	96.0	0.050		
LHL10□563J	56000.0				0.10	170.0	0.036		
LHL10□683J	68000.0		30.0	30.0	0.095	200.0	0.035	L:1kHz Q:0.0252	
LHL10□823J	82000.0				0.088	210.0	0.033		
LHL10□104J	100000.0				0.085	240.0	0.031		
LHL10□124J	120000.0				0.070	260.0	0.030		
LHL10□154J	150000.0				0.069	300.0	0.028		

形名の□には包装記号(TB：テーピング, NB：単品)が入ります。

□ Please specify the packaging code.(TB：Taping, NB：Bulk)

LHL13

形名 Ordering code	公称 インダクタンス Inductance [μH]	インダクタンス 許容差 Inductance Tolerance	Q (min.)	自己共振 周波数 Self-resonant frequency [MHz] (min.)	直流抵抗 DC Resistance [Ω] (max.)	定格電流 Rated current [A] (max.)	測定 周波数 Measuring frequency [MHz]
LHL13□100K	10.0	±10%	140.0	19.0	0.023	4.5	2.52
LHL13□150K	15.0		12.0	0.028	4.0		
LHL13□220K	22.0		7.6	0.035	3.4		
LHL13□330K	33.0		6.9	0.043	3.2		
LHL13□470K	47.0		5.6	0.052	2.8		
LHL13□680K	68.0		4.4	0.070	2.4		
LHL13□101K	100.0		50.0	3.3	0.12	2.0	0.796
LHL13□151K	150.0		2.6	0.19	1.5		
LHL13□221K	220.0		40.0	2.2	0.23	1.3	
LHL13□331K	330.0		30.0	1.8	0.35	1.1	
LHL13□471K	470.0	1.5		0.43	0.90		
LHL13□681K	680.0	1.2		0.61	0.80		
LHL13□102J	1000.0	±5%	40.0	1.0	1.2	0.60	0.252
LHL13□152J	1500.0			0.83	1.8	0.45	
LHL13□222J	2200.0			0.70	2.2	0.40	
LHL13□332J	3300.0			0.60	3.4	0.33	
LHL13□472J	4700.0		0.43	4.7	0.28		
LHL13□682J	6800.0		30.0	0.38	5.6	0.25	
LHL13□103J	10000.0		70.0	0.30	10	0.19	L:1kHz Q:0.0796MHz

形名の□には包装記号(TB：テーピング, NB：単品)が入ります。

□ Please specify the packaging code.(TB：Taping, NB：Bulk)

LHL16

形名 Ordering code	公称 インダクタンス Inductance [μH]	インダクタンス 許容差 Inductance Tolerance	Q (min.)	自己共振 周波数 Self-resonant frequency [MHz] (min.)	直流抵抗 DC Resistance [Ω] (max.)	定格電流 Rated current [A] (max.)	測定 周波数 Measuring frequency [MHz]
LHL16□470K	47.0	±10%	70.0	4.5	0.046	3.7	2.52
LHL16□680K	68.0			3.9	0.054	3.3	
LHL16□101K	100.0		60.0	2.7	0.077	2.9	0.796
LHL16□151K	150.0			2.3	0.11	2.4	
LHL16□221K	220.0			1.9	0.15	2.0	
LHL16□331K	330.0		40.0	1.6	0.21	1.5	0.252
LHL16□471K	470.0		30.0	1.4	0.28	1.3	
LHL16□681K	680.0	20.0	1.2	0.35	1.1		
LHL16□102J	1000.0		0.84	0.74	0.86		
LHL16□152J	1500.0		0.69	0.93	0.75		
LHL16□222J	2200.0	0.56	1.4	0.60			
LHL16□332J	3300.0	0.49	2.2	0.50			
LHL16□472J	4700.0	0.41	2.6	0.40			
LHL16□682J	6800.0	0.35	3.9	0.33			
LHL16□103J	10000.0	70.0	0.26	7.3	0.25	L:1kHz Q:0.0796MHz	

形名の□には包装記号(TB：テーピング, NB：単品)が入ります。

□ Please specify the packaging code.(TB：Taping, NB：Bulk)



LHF15BB

形名 Ordering code	公称 インダクタンス Inductance [μH]	L測定 周波数 L Measuring frequency	インダクタンス 許容差 Inductance Tolerance	Q (min.)	自己共振 周波数 Self-resonant frequency [MHz] (min.)	直流抵抗 DC Resistance [Ω] (max.)	定格電流 Rated current [A] (max.)	Q 測定周波数 Q Measuring frequency [MHz]
LHF15BB470K	47.0	1kHz	±10%	40.0	4.2	0.050	4.2	2.52
LHF15BB560K	56.0				4.1	0.056	3.8	
LHF15BB680K	68.0				3.5	0.065	3.5	
LHF15BB820K	82.0			25.0	3.0	0.080	3.2	0.796
LHF15BB101K	100.0				50.0	2.9	0.095	
LHF15BB121K	120.0			2.7		0.10	2.7	
LHF15BB151K	150.0			2.3		0.13	2.5	
LHF15BB181K	180.0			30.0	2.1	0.15	2.3	
LHF15BB221K	220.0				1.8	0.19	2.0	
LHF15BB271K	270.0				1.7	0.20	1.8	
LHF15BB331K	330.0				1.6	0.28	1.6	
LHF15BB391K	390.0			20.0	1.4	0.37	1.4	
LHF15BB471K	470.0				1.3	0.40	1.3	
LHF15BB561K	560.0			15.0	1.3	0.46	1.2	
LHF15BB681K	680.0				1.0	0.62	1.1	
LHF15BB821K	820.0			5.0	0.92	0.70	1.0	0.252
LHF15BB102J	1000.0			20.0	1.0	0.67	0.95	
LHF15BB122J	1200.0				0.90	0.75	0.85	
LHF15BB152J	1500.0				0.75	1.1	0.75	
LHF15BB182J	1800.0				0.72	1.2	0.67	
LHF15BB222J	2200.0	0.65	1.4		0.60			
LHF15BB272J	2700.0	0.52	1.9		0.55			
LHF15BB332J	3300.0	0.50	2.2		0.50			
LHF15BB392J	3900.0	0.48	2.4		0.45			
LHF15BB472J	4700.0	15.0	0.44		2.8	0.40		
LHF15BB562J	5600.0		0.39		3.7	0.36		
LHF15BB682J	6800.0		0.37	4.3	0.33			
LHF15BB822J	8200.0		0.30	5.7	0.30			
LHF15BB103J	10000.0	70.0	0.28	6.6	0.25	0.0796		

LHFP13BB

形名 Ordering code	公称 インダクタンス Nominal Inductance [H]	L測定 周波数 L Measuring frequency	インダクタンス 許容差 Inductance Tolerance [%]	直流抵抗 DC Resistance [Ω] (max.)	自己共振 周波数 Self-resonant frequency [MHz] (min.)	定格電流 Rated current [A] (max.)
LHFP13BB100M	10μ	1kHz	±20	0.024	22.0	4.4
LHFP13BB150M	15μ			0.030	16.0	4.0
LHFP13BB220M	22μ			0.033	9.7	3.6
LHFP13BB330M	33μ			0.040	7.6	3.2
LHFP13BB470K	47μ			0.058	4.4	2.6
LHFP13BB680K	68μ		0.10	4.2	1.9	
LHFP13BB101K	100μ		0.15	2.6	1.6	
LHFP13BB151K	150μ		0.19	2.0	1.4	
LHFP13BB221K	220μ		0.30	1.7	1.1	
LHFP13BB331K	330μ		0.49	1.3	0.84	
LHFP13BB471K	470μ		0.58	1.1	0.77	
LHFP13BB681K	680μ		0.93	0.90	0.60	
LHFP13BB102K	1.0m		1.4	0.78	0.50	
LHFP13BB152K	1.5m		2.3	0.50	0.38	
LHFP13BB222K	2.2m		2.9	0.42	0.34	
LHFP13BB332K	3.3m		4.2	0.38	0.28	
LHFP13BB472K	4.7m		6.2	0.28	0.23	
LHFP13BB682K	6.8m		9.7	0.22	0.18	
LHFP13BB103K	10m		12.0	0.19	0.16	

LHFP15BB

形名 Ordering code	公称 インダクタンス Nominal Inductance [H]	L測定 周波数 L Measuring frequency	インダクタンス 許容差 Inductance Tolerance [%]	直流抵抗 DC Resistance [Ω] (max.)	自己共振 周波数 Self-resonant frequency [MHz] (min.)	定格電流 Rated current [A] (max.)
LHFP15BB470K	47μ	1kHz	±10	0.044	8.5	3.3
LHFP15BB680K	68μ			0.055	3.8	2.9
LHFP15BB101K	100μ			0.075	2.4	2.5
LHFP15BB151K	150μ			0.13	2.0	1.9
LHFP15BB221K	220μ			0.20	1.3	1.6
LHFP15BB331K	330μ			0.30	0.93	1.3
LHFP15BB471K	470μ			0.36	0.87	1.1
LHFP15BB681K	680μ			0.56	0.66	0.90
LHFP15BB102K	1.0m			0.70	0.55	0.80
LHFP15BB152K	1.5m			1.2	0.44	0.62
LHFP15BB222K	2.2m			1.9	0.33	0.50
LHFP15BB332K	3.3m			2.3	0.28	0.45
LHFP15BB472K	4.7m			3.5	0.23	0.36
LHFP15BB682K	6.8m			5.4	0.16	0.28
LHFP15BB103K	10m			6.7	0.14	0.25

直流重畳特性例 DC Bias characteristics

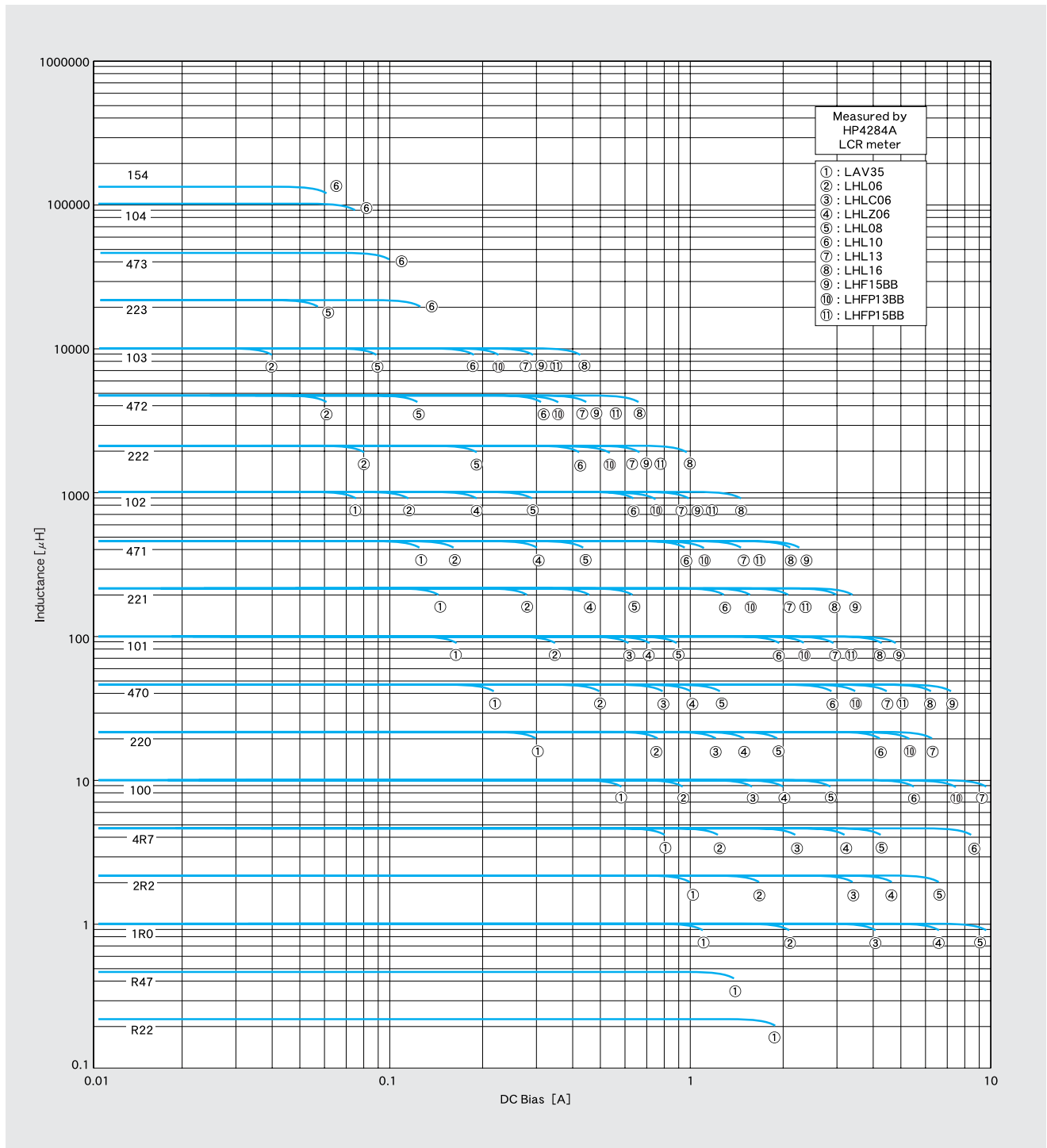

インダクタンス温度特性例 Temperature characteristics

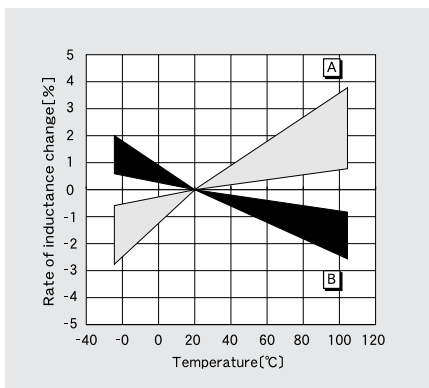

- A** : LAV35  
 LHL06(120K~103J)  
 LHLC06  
 LHLZ06  
 LHL08  
 LHL10  
 LHL13  
 LHL16  
 LHF15BB  
 LHFP13BB  
 LHFP15BB

- B** : LHL 06(1R0M~100K)

Q-周波数特性例 Q-vs-Frequency characteristics

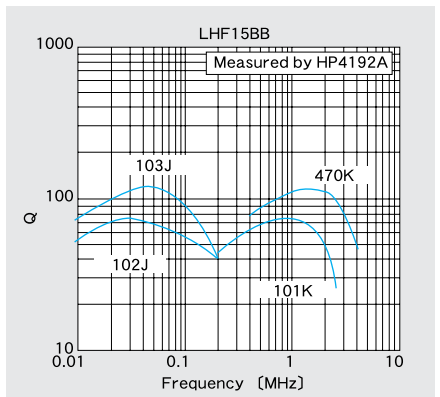
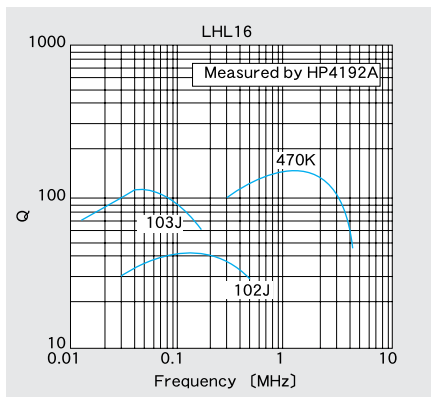
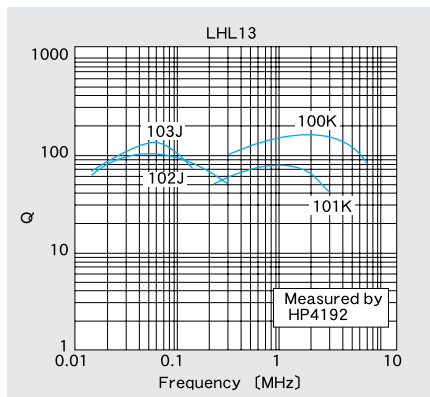
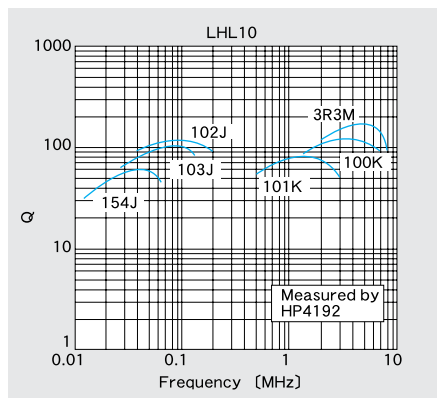
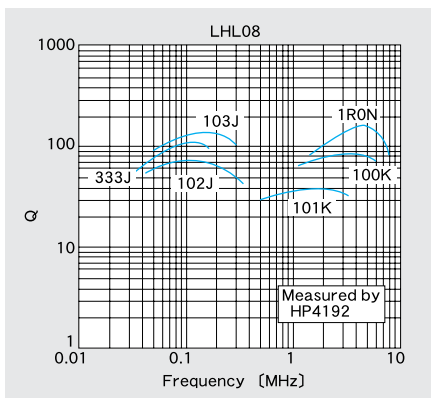
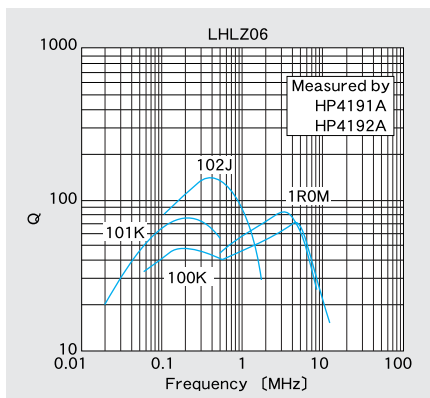
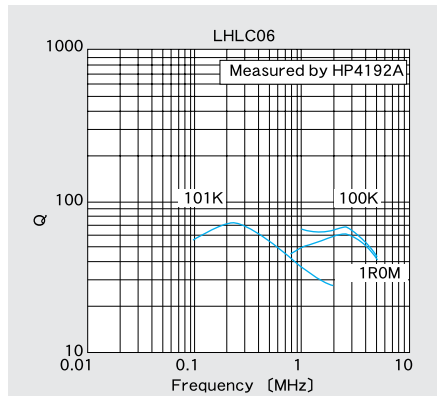
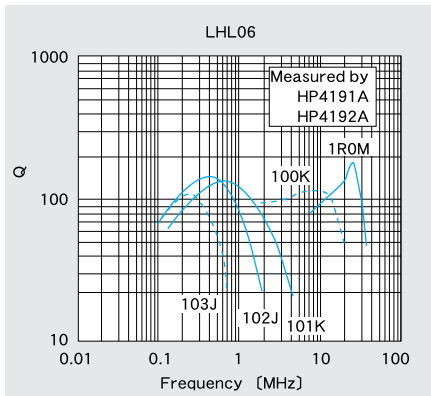
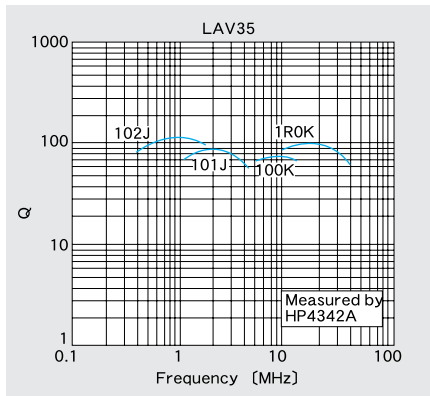

①標準数量 Standard quantity

形式(EIA) Type	標準数量(pcs) Standard quantity		
	箱づめ Box	袋づめ Bulk	テーピング Taped
LAV 35	—	—	2000
LHL 06	—	500	2000
LHLC06	—	500	2000
LHLZ06	—	500	1500
LHL 08	—	100	1000
LHL 10	—	50	500
LHL 13	—	25	500
LHL 16	500	—	250
LHF 15BB	500	—	—
LHFP13BB	500	—	—
LHFP15BB	500	—	—

②製品単品寸法 Bulk dimensions

LHL06/LHLC06/LHLZ06

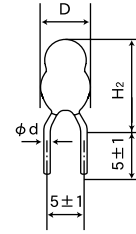

形式 Type	寸法 Dimensions(mm)		
	φD	H <sub>2</sub>	φd
LHL 06	6.8max (0.268max)	11.0max (0.433max)	0.6±0.05 (0.024±0.002)
LHLC06	7.5max (0.295max)	11.0max (0.433max)	0.6±0.05 (0.024±0.002)
LHLZ06	7.8max (0.307max)	11.0max (0.433max)	0.6±0.05 (0.024±0.002)

Unit : mm(inch)

LHL08~16

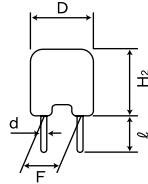

形式 Type	寸法 Dimensions(mm)				
	φD(max)	H <sub>2</sub> (max)	F*	ℓ	d
LHL 08	9.0 (0.354)	9.5 (0.374)	5.0±1.0 (0.197±0.039)	5.0±1.0 (0.197±0.039)	0.6±0.05 (0.024±0.002)
LHL 10	11.0 (0.433)	14.0 (0.551)	5.0±1.0 (0.197±0.039)	5.0±1.0 (0.197±0.039)	0.6±0.05 (0.024±0.002)
LHL 13	14.0 (0.551)	17.0 (0.669)	7.5±1.0 (0.295±0.039)	5.0±1.0 (0.197±0.039)	0.8±0.05 (0.031±0.002)
LHL 16	17.0 (0.669)	21.0 (0.827)	7.5±1.0 (0.295±0.039)	5.0±1.0 (0.197±0.039)	0.8±0.05 (0.031±0.002)

\*リード端子根本(接着部)寸法とする。 Unit : mm(inch)  
\*Measured at the base of the leads.

LHF15BB

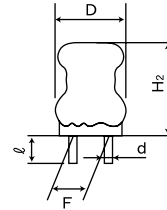

形式 Type	寸法 Dimensions(mm)				
	φD(max)	H <sub>2</sub> (max)	F*	ℓ	d
LHF 15BB	18.0 (0.709)	23.0 (0.906)	10.0±1.0 (0.394±0.039)	5.0±1.0 (0.197±0.039)	1.0±1.0 (0.039±0.039)

\*リード端子根本(接着部)寸法とする。 Unit : mm(inch)  
\*Measured at the base of the leads.

LHFP13BB

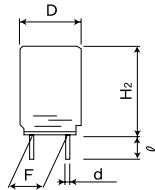

形式 Type	寸法 Dimensions(mm)				
	φD(max)	H <sub>2</sub> (max)	F*	ℓ	d
LHFP13BB	14.5 (0.571)	20.0 (0.788)	7.5±1.0 (0.295±0.039)	5.0±1.0 (0.197±0.039)	0.8±0.05 (0.031±0.002)

\*リード端子根本寸法とする。 Unit : mm(inch)  
\*Measured at the base of the leads.

LHFP15BB

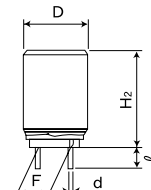

形式 Type	寸法 Dimensions(mm)				
	φD(max)	H <sub>2</sub> (max)	F*	ℓ	d
LHFP15BB	16.0 (0.630)	23.0 (0.906)	7.5±1.0 (0.295±0.039)	5.0±1.0 (0.197±0.039)	0.8±0.05 (0.031±0.002)

\*リード端子根本寸法とする。 Unit : mm(inch)  
\*Measured at the base of the leads.

③テーピング寸法 Taping dimensions  
 ・LAV35VB

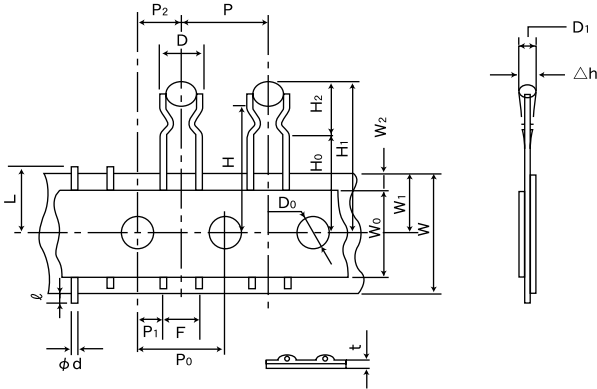

形式 Type	記号 Symbol	寸法 Dimensions	記号 Symbol	寸法 Dimensions
LAV35 VB	D	6.0max (0.236max)	$\Delta h$	0.0±2.0 (0.0±0.079)
	D <sub>1</sub>	4.0max (0.157max)	W	18.0 <sup>+1.0</sup> <sub>-0.5</sub> (0.709 <sup>+0.039</sup> <sub>-0.020</sub> )
	H <sub>1</sub>	25.0max (0.984max)	W <sub>0</sub>	12.5min (0.492min)
	H <sub>2</sub>	8.0max (0.315max)	W <sub>1</sub>	9.0 <sup>+0.75</sup> <sub>-0.5</sub> (0.354 <sup>+0.030</sup> <sub>-0.020</sub> )
	H	19.0(参考値 Ref.) (0.748)	W <sub>2</sub>	3.0max <sup>**2</sup> (0.118max)
	H <sub>0</sub>	16.0±1.0 (0.630±0.039)	$\ell$	2.0max (0.079max)
	P	12.7±1.0 (0.500±0.039)	D <sub>0</sub>	4.0±0.3 (0.157±0.012)
	P <sub>0</sub>	12.7±0.3 <sup>**1</sup> (0.500±0.012)	$\phi d$	0.50±0.05 (0.020±0.002)
	P <sub>1</sub>	3.85±0.5 (0.152±0.020)	L	11.0max (0.433max)
	P <sub>2</sub>	6.35±1.3 (0.250±0.051)	t	0.5±0.2 (0.020±0.008)
F	5.0 <sup>+0.8</sup> <sub>-0.3</sub> (0.197 <sup>+0.031</sup> <sub>-0.012</sub> )		Unit : mm(inch)	

※1 20ピッチにつき、累積誤差±1mm以内。  
 ※2 貼付テープは台紙よりはみ出さないこと。  
 ※1 Accumulated error for 20 pitches is ± 1mm.  
 ※2 Bonding tape must not protrude from the base tape.

・LHL06/LHLC06/LHLZ06

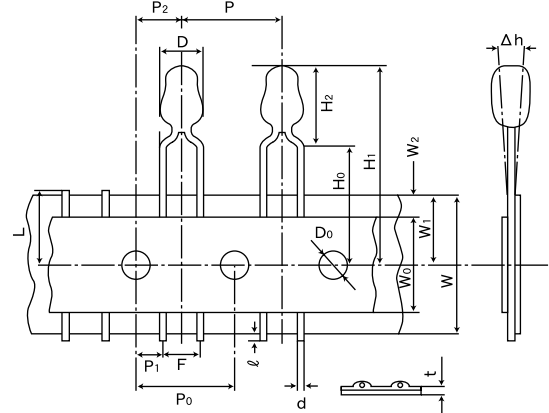

形式 Type	記号 Symbol	寸法 Dimensions	記号 Symbol	寸法 Dimensions
LHL 06 LHLC06 LHLZ06	D	$\phi 6.8(0.268)(L06)$ $\phi 7.5(0.295)(LCC6)$ $\phi 7.8(0.307)(LZC6)$	W	18.0 <sup>+1.0</sup> <sub>-0.5</sub> (0.709 <sup>+0.039</sup> <sub>-0.020</sub> )
	H <sub>1</sub>	30.0max (1.18max)	W <sub>0</sub>	12.5min (0.492min)
	H <sub>2</sub>	11.0max (0.433max)	W <sub>1</sub>	9.0±0.5 (0.354±0.020)
	H <sub>0</sub>	16.0±1.0 (0.630±0.039)	W <sub>2</sub>	3.0max <sup>**2</sup> (0.118max)
	P	12.7±1.0 (0.500±0.039)	$\ell$	2.0max (0.079max)
	P <sub>0</sub>	12.7±0.3 <sup>**1</sup> (0.500±0.012)	D <sub>0</sub>	$\phi 4.0\pm 0.2$ ( $\phi 0.157\pm 0.008$ )
	P <sub>1</sub>	3.85±0.7 (0.152±0.028)	d	$\phi 0.6\pm 0.05$ ( $\phi 0.024\pm 0.002$ )
	P <sub>2</sub>	6.35±1.3 (0.250±0.051)	L	11.0max (0.433max)
	F	5.0 <sup>+0.8</sup> <sub>-0.2</sub> (0.0 <sup>+0.031</sup> <sub>-0.008</sub> )	t	0.6±0.3 (0.024±0.012)
	$\Delta h$	0.0±2.0 (0.0±0.079)		Unit : mm(inch)

※1 20ピッチにつき、累積誤差±1mm以内。  
 ※2 貼付テープは台紙よりはみ出さないこと。  
 ※1 Accumulated error for 20 pitches is ± 1mm.  
 ※2 Bonding tape must not protrude from the base tape.

・LHL08~16

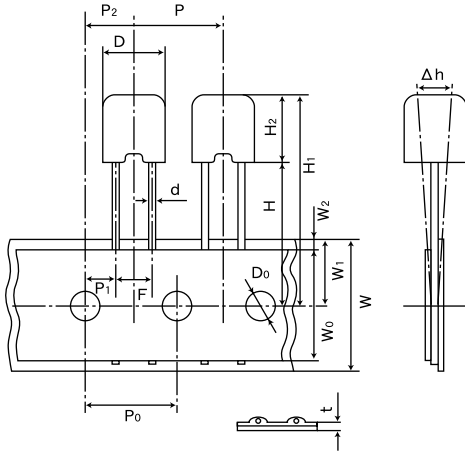

	LHL08	LHL10	LHL13	LHL16
D	φ9.0max (φ0.354max)	φ11.0max (φ0.433max)	φ14.0max (φ0.551max)	φ17.0max (φ0.669max)
H <sub>1</sub>	30.5max (1.20max)	34.0max (1.34max)	37.0max (1.46max)	41.0max (1.61max)
H	18.0 <sup>+2.0</sup> <sub>-0.0</sub> (0.709 <sup>+0.079</sup> <sub>-0.000</sub> )	18.0 <sup>+2.0</sup> <sub>-0.0</sub> (0.709 <sup>+0.079</sup> <sub>-0.000</sub> )	18.0 <sup>+2.0</sup> <sub>-0.0</sub> (0.709 <sup>+0.079</sup> <sub>-0.000</sub> )	18.0 <sup>+2.0</sup> <sub>-0.0</sub> (0.709 <sup>+0.079</sup> <sub>-0.000</sub> )
H <sub>2</sub>	9.5max (0.374max)	14.0max (0.551max)	17.0max (0.669max)	21.0max (0.827max)
P	12.7±1.0 (0.500±0.039)	12.7±1.0 (0.500±0.039)	15.0±1.0 (0.591±0.039)	30.0±1.0 (1.18±0.039)
P <sub>0</sub>	12.7±0.3 <sup>*1</sup> (0.500±0.012)	12.7±0.3 <sup>*1</sup> (0.500±0.012)	15.0±0.3 <sup>*1</sup> (0.591±0.012)	15.0±0.3 <sup>*1</sup> (0.591±0.012)
P <sub>1</sub>	3.85±0.7 (0.152±0.028)	3.85±0.7 (0.152±0.028)	3.75±0.7 (0.148±0.028)	3.75±0.7 (0.148±0.028)
P <sub>2</sub>	6.35±1.3 (0.250±0.051)	6.35±1.3 (0.250±0.051)	7.50±1.3 (0.295±0.051)	7.50±1.3 (0.295±0.051)
F	5.0 <sup>+0.8</sup> <sub>-0.2</sub> (0.197 <sup>+0.031</sup> <sub>-0.008</sub> )	5.0 <sup>+0.8</sup> <sub>-0.2</sub> (0.197 <sup>+0.031</sup> <sub>-0.008</sub> )	7.50 <sup>+0.8</sup> <sub>-0.2</sub> (0.295 <sup>+0.031</sup> <sub>-0.008</sub> )	7.50±0.5 (0.295±0.020)
h	0.0±2.0 (0.0±0.079)	0.0±2.0 (0.0±0.079)	0.0±2.0 (0.0±0.079)	0.0±2.0 (0.0±0.079)
W	18.0 <sup>+1.0</sup> <sub>-0.5</sub> (0.709 <sup>+0.039</sup> <sub>-0.020</sub> )	18.0 <sup>+1.0</sup> <sub>-0.5</sub> (0.709 <sup>+0.039</sup> <sub>-0.020</sub> )	18.0 <sup>+1.0</sup> <sub>-0.5</sub> (0.709 <sup>+0.039</sup> <sub>-0.020</sub> )	18.0 <sup>+1.0</sup> <sub>-0.5</sub> (0.709 <sup>+0.039</sup> <sub>-0.020</sub> )
W <sub>0</sub>	12.5min (0.492min)	12.5min (0.492min)	12.5min (0.492min)	12.5min (0.492min)
W <sub>1</sub>	9.0±0.5 (0.354±0.020)	9.0±0.5 (0.354±0.020)	9.0±0.5 (0.354±0.020)	9.0±0.5 (0.354±0.020)
W <sub>2</sub>	3.0max <sup>*2</sup> (0.118max)	3.0max <sup>*2</sup> (0.118max)	3.0max <sup>*2</sup> (0.118max)	3.0max <sup>*2</sup> (0.118max)
D <sub>0</sub>	φ4.0±0.2 (φ0.158±0.008)	φ4.0±0.2 (φ0.158±0.008)	φ4.0±0.2 (φ0.158±0.008)	φ4.0±0.2 (φ0.158±0.008)
d	φ0.6±0.05 (φ0.024±0.002)	φ0.6±0.05 (φ0.024±0.002)	φ0.8±0.05 (φ0.031±0.002)	φ0.8±0.05 (φ0.031±0.002)
t	0.6±0.3 (0.024±0.012)	0.6±0.3 (0.024±0.012)	0.6±0.3 (0.024±0.012)	0.6±0.3 (0.024±0.012)

※1 累積ピッチ誤差は20ピッチにつき1mm以内。 Unit : mm(inch)  
 ※2 貼付テープは台紙よりはみ出さないこと。  
 ※1 Accumulated error for 20 pitches is 1mm.  
 ※2 Bonding tape must not protrude from the base tape.





Item	Specified Value								Test Method and Remarks
	LA02 Type/ LA03 Type	LA04 Type	LA05 Type	LHL□□□/ LHF15BB/ LHFP□□BB	FBA/FBR	LAV35	FL05□ Type	FL06BT Type	
1. Operating temperature Range	-25~+105°C				-25~+85°C	-25~+105°C			LA・FL : Including self-generated heat  LHL・LHF・LHFP : Including self-generated heat [LHL□□□, LHF15BB]
2. Storage temperature Range	-40~+85°C								
3. Rated current	Within the specified tolerance								LA : The maximum DC value having inductance within 10% and temperature increase within 20°C by the application of DC bias.  LHL・LHF・LHFP・LAV35 : The maximum DC value having inductance decrease within 10% and temperature increase within the following specified temperature by the application of DC bias. 規定温度：20°C(LHL06, LAV35) : 25°C(LHL08, LHL10, LHL13) : 30°C(LHLC06, LHLZ06, LHL16, LHF15BB, LHFP□□BB)  FB : No disconnection or appearance abnormality by continuous current application for 30 min. Chage after the application shall be within ±20% of the initial value.This is not guaranteed for electrical characteristics during current application.  FL : The maximum DC value having temperature rise within specified value.
4. Impedance					Within the specified tolerance			Refer to individual specification	FB : Measuring equipment : Impedance analyzer (HP4191A) or its equivalent Measuring frequency : Specified frequency  FL06BT : Measuring equipment : 4291A (HP) or its equivalent Measuring frequency : Specified frequency
5. Inductance	Within the specified tolerance					Within the specified tolerance			LA : Measuring equipment : LCR meter(HP4285A + HP42851A or its equivalent) Measuring frequency : Specified frequency LHL・LHF・LHFP : Measuring equipment : Q meter(HP4285A+HP42851A or its equivalent) LCR meter( HP4262A) or its equivalent(at 1KHz) Measuring frequency : Specified frequency  LAV35 : Measuring equipment : Q meter(HP4285A+HP42851A or its equivalent) Measuring frequency : Specified frequency  FL05R□ : Measuring equipment : HP4262A or its equivalent. Measuring frequency : 1KHz

Item	Specified Value								Test Method and Remarks												
	LA02 Type/ LA03 Type	LA04 Type	LA05 Type	LHL□□□/ LHF15BB/ LHFP□□BB	FBA/FBR	LAV35	FL05□ Type	FL06BT Type													
6.Q	Within the specified tolerance					Within the specified tolerance			LA : Measuring equipment : LCR meter(HP4285A+HP42851A or its equivalent) Measuring frequency : Specified frequency  LHL · LHF · LHFP · LAV35 : Measuring equipment : Q meter(HP4285A+HP42851A or its equivalent) Q meter(HP4342A) or its equivalent Measuring frequency : Specified frequency												
7.DC Resistance	Within the specified tolerance								LA : Measuring equipment : low ohmmeter (A&D AD5812 or its equivalent)  LHL · LHF · LHFP · FB · LAV35 · FL : Measuring equipment : DC ohmmeter												
8.Self resonance frequency	Within the specified tolerance					Within the specified tolerance			LA : Measuring equipment : Network analyzer(Anritsu MS620J or its equivalent)  LHL · LHF · LHFP · LAV35 : Measuring equipment : (HP4191A, 4192A) its equivalent												
9.Temperature characteristic	$\Delta L/L$ : Within±5%			$\Delta L/L$ : Within±7%		$\Delta L/L$ : Within±5%			LA : Change of maximum inductance deviation in step 1to5 <table border="1" style="margin-left: 20px;"> <thead> <tr> <th>step</th> <th>Temperature(°C)</th> </tr> </thead> <tbody> <tr> <td>1</td> <td>20</td> </tr> <tr> <td>2</td> <td>-25 (Minimum operating temperature)</td> </tr> <tr> <td>3</td> <td>20 (Standard temperature)</td> </tr> <tr> <td>4</td> <td>+85 (Maximum operating temperature)</td> </tr> <tr> <td>5</td> <td>20</td> </tr> </tbody> </table> LHL · LHF · LHFP · LAV35 : [LHL□□□, LHF15BB, LAV35, LHFP□□BB] Change of maximum inductance deviation in step 1to5 Temperature at step 1 : 20°C Temperature at step 2 : Minimum operating temperature Temperature at step 3 : 20°C (Standard temperature) Temperature at step 4 : Maximum operating temperature Temperature at step 5 : 20°C	step	Temperature(°C)	1	20	2	-25 (Minimum operating temperature)	3	20 (Standard temperature)	4	+85 (Maximum operating temperature)	5	20
step	Temperature(°C)																				
1	20																				
2	-25 (Minimum operating temperature)																				
3	20 (Standard temperature)																				
4	+85 (Maximum operating temperature)																				
5	20																				

Item	Specified Value								Test Method and Remarks																					
	LA02 Type/ LA03 Type	LA04 Type	LA05 Type	LHL□□□/ LHF15BB/ LHFP□□BB	FBA/FBR	LAV35	FL05□ Type	FL06BT Type																						
10. Terminal strength : tensile force	No abnormality such as cut lead, or looseness.			No abnormality such as cut lead, or looseness.	No abnormality such as cut lead, or looseness.				LA : Apply the stated tensile force progressively in the direction to draw terminal. <table border="1"> <tr> <th>force(N)</th> <th>duration(S)</th> </tr> <tr> <td>25</td> <td>5</td> </tr> </table> LHL · LHF · LAV · LHFP : Apply the stated tensile force progressively in the direction to draw terminal. <table border="1"> <tr> <th>Nominal wire diameter tensile <math>\phi d</math>(mm)</th> <th>force (N)</th> <th>duration(S)</th> </tr> <tr> <td>0.3 &lt; <math>\phi d</math> ≤ 0.5</td> <td>5</td> <td rowspan="3">30±5</td> </tr> <tr> <td>0.5 &lt; <math>\phi d</math> ≤ 0.8</td> <td>10</td> </tr> <tr> <td>0.8 &lt; <math>\phi d</math> ≤ 1.2</td> <td>25</td> </tr> </table> FBA : 本体を固定し、端子方向に20±1Nの引張力を10±1秒間加える。  FL05R□ : Fix the component in the direction to draw terminal, and gradually apply the tensile force of 4.9 N.	force(N)	duration(S)	25	5	Nominal wire diameter tensile $\phi d$ (mm)	force (N)	duration(S)	0.3 < $\phi d$ ≤ 0.5	5	30±5	0.5 < $\phi d$ ≤ 0.8	10	0.8 < $\phi d$ ≤ 1.2	25							
force(N)	duration(S)																													
25	5																													
Nominal wire diameter tensile $\phi d$ (mm)	force (N)	duration(S)																												
0.3 < $\phi d$ ≤ 0.5	5	30±5																												
0.5 < $\phi d$ ≤ 0.8	10																													
0.8 < $\phi d$ ≤ 1.2	25																													
11. Over current				There shall be no scorch or short of wire.					LHL · LHF · LHFP : Measuring current : Rated current×2 Duration : 5min. Number of measuring : one time																					
12. Terminal strength : bending	No abnormality such as cut lead, or looseness.								LA : Suspend a mass at the end the terminal, incline the body though angel of 90 and return it to initial position. This operation is done over a period of 2-3 sec. Then second bend in the opposite direction shall be made. Number of bends : Two times. <table border="1"> <tr> <th>Nominal wire diameter tensile <math>\phi d</math>(mm)</th> <th>Bending force (N)</th> <th>Mass reference weight (kg)</th> </tr> <tr> <td>0.3 &lt; <math>\phi d</math> ≤ 0.5</td> <td>2.5</td> <td>0.25</td> </tr> <tr> <td>0.5 &lt; <math>\phi d</math> ≤ 0.8</td> <td>5</td> <td>0.50</td> </tr> </table> LH · FB · LAV : Suspend a mass at the end the terminal, incline the body though angel of 90 and return it to initial position. This operation is done over a period of 2-3 sec. Then second bend in the opposite direction shall be made. Number of bends : Two times. <table border="1"> <tr> <th>Nominal wire diameter tensile <math>\phi d</math>(mm)</th> <th>Bending force (N)</th> <th>Mass reference weight (kg)</th> </tr> <tr> <td>0.3 &lt; <math>\phi d</math> ≤ 0.5</td> <td>2.5</td> <td>0.25</td> </tr> <tr> <td>0.5 &lt; <math>\phi d</math> ≤ 0.8</td> <td>5</td> <td>0.5</td> </tr> <tr> <td>0.8 &lt; <math>\phi d</math> ≤ 1.2</td> <td>10</td> <td>1.0</td> </tr> </table>	Nominal wire diameter tensile $\phi d$ (mm)	Bending force (N)	Mass reference weight (kg)	0.3 < $\phi d$ ≤ 0.5	2.5	0.25	0.5 < $\phi d$ ≤ 0.8	5	0.50	Nominal wire diameter tensile $\phi d$ (mm)	Bending force (N)	Mass reference weight (kg)	0.3 < $\phi d$ ≤ 0.5	2.5	0.25	0.5 < $\phi d$ ≤ 0.8	5	0.5	0.8 < $\phi d$ ≤ 1.2	10	1.0
Nominal wire diameter tensile $\phi d$ (mm)	Bending force (N)	Mass reference weight (kg)																												
0.3 < $\phi d$ ≤ 0.5	2.5	0.25																												
0.5 < $\phi d$ ≤ 0.8	5	0.50																												
Nominal wire diameter tensile $\phi d$ (mm)	Bending force (N)	Mass reference weight (kg)																												
0.3 < $\phi d$ ≤ 0.5	2.5	0.25																												
0.5 < $\phi d$ ≤ 0.8	5	0.5																												
0.8 < $\phi d$ ≤ 1.2	10	1.0																												
13. Insulation resistance : between the terminals and body				100M $\Omega$ min.					LHL · LHF : Applied voltage : 500 VDC Duration : 60 sec.																					
14. Insulation resistance : between terminals and core				1M $\Omega$ min. (Other than material code MA)					FBA · FBR : Applied voltage : 100 VDC Duration : 60±5 sec.																					
15. Withstanding : between the terminals and body				No abnormality such as insulation damage					[LHL□□□, LHF15BB] According to JIS C5102. 7. 1. 3 (C) Metal global method Applied voltage : 500 VDC Duration : 60 sec.																					

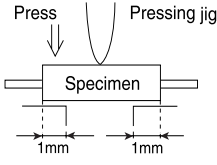
Item	Specified Value								Test Method and Remarks
	LA02 Type/ LA03 Type	LA04 Type	LA05 Type	LHL□□□/ LHF15BB/ LHFP□□BB	FBA/FBR	LAV35	FL05□ Type	FL06BT Type	
16.DC bias characteristic	ΔL/L : Within -10%					ΔL/L : -10% Within			LA · LAV35 : Measure inductance with application of rated current using LCR meter to compare it with the initial value.
17.Body strength	No abnormality as damage.				No significant damage such as cracks on body.	No abnormality as damage.			LA02 · LAV35 : Applied force : 30N Duration : 10 sec. Speed : Shall attain to specified force in 2 sec.  LA03 · LA04 · LA05 : Applied force : 50N Duration : 10 sec. Speed : Shall attain to specified force in 2 sec.  FB : Applied force : 50±3N Duration : 30±1 sec.  
18.Resisitance to vibration	ΔL/L : Within±5% Q : 30min.	ΔL/L : Within±5% ΔQ/Q : Within±10%	ΔL/L : Within±5% Q : 15min.	Appearance : No abnormality ΔL/L : Within±5% Q change : Within±30%	Appearance : No abnormality Impedance change : Within±20%	ΔL/L : Within±5% Q : 30min.			LA : Accoding to JIS C5102 8. 2 Vibration type : A Directions : 2 hrs each in X, Y and Z directions total : 6hrs. Frequency range : 10 to 55 to 10Hz(1min.) Amplitude : 1.5mm Mounting method : Soldering onto printed board. Recovery : At least 1hr of recovery under the standard condition after the test, followed by the measurement within 2hrs.  LHL · LHF · LHFP · FB · LAV : Accoding to JIS C0040 Vibration type : A Directions : 2 hrs each in X, Y and Z directions total : 6hrs. Frequency range : 10 to 55 to 10Hz(1min.) Amplitude : 1.5mm (But don't exceed acceleration 196m/s (two power) Mounting method : Soldering onto printed board.

Item	Specified Value								Test Method and Remarks
	LA02 Type/ LA03 Type	LA04 Type	LA05 Type	LHL□□□/ LHF15BB/ LHFP□□BB	FBA/FBR	LAV35	FL05□ Type	FL06BT Type	
19. Resistance to shock	No significant abnormality in appearance					No significant abnormality in appearance			LA・LAV35 : Drop test Impact material : concrete or vinyl tile Height : 1m Total number of drops : 10 times
20. Solderability	At least 75% of terminal electrode is covered by new solder.		At least 75% of lead circumference is covered by new solder.	At least 90% of lead circumference is covered by new solder.		At least 75% of lead circumference is covered by new solder.			LA : Solder temperature : 230±5°C Duration : 2±0.5 sec.  LHL・LHF・LHFP : Solder temperature : 235±5°C Duration : 2±0.5 sec. Immersion depth : Up to 1.5mm from bottom of kinked part. [LHL06, LHLC06, LHLZ06] : Up to 1.5mm from bottom of case. [LHL08, LHL10, LHL13, LHL16] : Up to 1.5mm from bottom of base. [LHF15BB, LHFP□□BB]  FB : Solder temperature : 230±5°C Duration : 3±1 sec. Immersion depth : Up to 1.5mm from terminal root.  LAV35 : Solder temperature : 230±5°C Duration : 2±0.5 sec.  FL05R□ : Solder temperature : 230±5°C Duration : 2±0.5 sec. Immersion depth : Up to 2~2.5mm from terminal root.  FL06BT : Solder temperature : 230±5°C Duration : 3±1 sec. Immersion depth : Up to 0.5~1.0mm from terminal root.

Item	Specified Value								Test Method and Remarks
	LA02 Type/ LA03 Type	LA04 Type	LA05 Type	LHL□□□□/ LHF15BB/ LHFP□□BB	FBA/FBR	LAV35	FL05□ Type	FL06BT Type	
21. Resistance to soldering heat	No significant abnormality in appearance		△L/L : Within ±5% Q : 15min.	No significant abnormality in appearance Inductance change : Within±5% Q change : Within±30%	No significant abnormality in appearance Impedance change : Within±20%	△L/L : Within±5% Q : 30min.	Refer to individual specification	No significant abnormality in appearance Impedance change : Within±20%	<p>LA :</p> <p>Solder temperature : 260±5°C(LA02) 270±5°C(LA03 · LA04 · LA05)</p> <p>Duration : 5±0.5 sec. One time</p> <p>Immersion conditions : Inserted into substrate with t = 1.6mm</p> <p>Recovery : At least 1hr of recovery under the standard condition after the test, followed by the measurement within 2hrs.</p> <p>LHL · LHF · LHFP :</p> <p>Solder bath method</p> <p>Solder temperature : 260±5°C</p> <p>Duration : 10±1 sec.</p> <ul style="list-style-type: none"> <li>: Up to 1.5mm from bottom of kinked part. [LHL06, LHLC06, LHLZ06]</li> <li>: Up to 1.5mm from bottom of case. [LHL08, LHL10, LHL13, LHL16]</li> <li>: Up to 1.5mm from bottom of base. [LHF15BB, LHFP□□BB]</li> </ul> <p>Manual soldering</p> <p>Solder temperature : 350±10°C(At the tip of soldering iron)</p> <p>Duration : 5±1 sec.</p> <ul style="list-style-type: none"> <li>: Up to 1.5mm from bottom of kinked part. [LHL06, LHLC06, LHLZ06]</li> <li>: Up to 1.5mm from bottom of case. [LHL08, LHL10, LHL13, LHL16]</li> <li>: Up to 1.5mm from bottom of base. [LHF15BB, LHFP□□BB]</li> </ul> <p>Caution : No excessive pressing shall be applied to terminal</p> <p>Recovery : 4 to 24hrs of recovery under the standard condition after the test.</p> <p>FB :</p> <p>Solder bath method</p> <p>Condition 1</p> <p>Solder temperature : 260±5°C</p> <p>Duration : 10±1 sec.</p> <p>Immersion depth : Up to 1.5mm from terminal root.</p> <p>Condition 2</p> <p>Solder temperature : 350±5°C</p> <p>Duration : 3±1 sec.</p> <p>Immersion depth : Up to 1.5mm from terminal root.</p> <p>Recovery : 3hrs of recovery under the standard condition after the test.</p> <p>LAV35 :</p> <p>Solder temperature : 260±5°C</p> <p>Duration : 5±0.5 sec.</p> <p>Immersion depth : Up to 2.0 to 2.5mm from bottom of kinked part.</p> <p>Recovery : 4 to 24hrs of recovery under the standard condition after the test.</p> <p>FL :</p> <p>Solder condition : 260±5°C 10±1 sec.</p> <p>Immersion depth : Up to 0.5 to 1.0mm from terminal root.</p> <p>Recovery : 3hrs of recovery under the standard condition after the test.</p>

Item	Specified Value								Test Method and Remarks																																																												
	LA02 Type/ LA03 Type	LA04 Type	LA05 Type	LHL□□□/ LHF15BB/ LHFP□□BB	FBA/FBR	LAV35	FL05□ Type	FL06BT Type																																																													
22. Resisittance to solvent	Pleasa avoid the ultrasonic cleaning of this product.				No signifi- cant abnor- mality in ap- pearance Impedance change : Within±20%	P l e a s e avoid the ul- tr a s o n i c cleaning of this product.			FB : Solvent temperature : 20~25°C Duration : 30±5 sec. Solvent type : Acetone, trichloroethylene Recovery : 3hrs of recovery under the standard condition after the test.																																																												
23. Thermnal shock	△L/L : Within±10% Q : 30min.	△L/L : Within±10% △Q/Q : Within±30%	△L/L : Within±10% Q : 15min.	Appearance : No abnor- mality Inductance change : Within±10% Q change : Within±30%	Appearance : No abnor- mality Impedance change : Within±20%	△L/L : Within±10% Q : 20min.	Refer to individual specifica- tion	Appearance : No abnor- mality Impedance change : Within±20%	LA : Conditions for 1cycle <table border="1"> <thead> <tr> <th>Step</th> <th>Temperature(°C)</th> <th>Duration(min)</th> </tr> </thead> <tbody> <tr> <td>1</td> <td>-25<sup>+0</sup><sub>-3</sub></td> <td>30±3</td> </tr> <tr> <td>2</td> <td>Room temperature</td> <td>Within 3</td> </tr> <tr> <td>3</td> <td>+85<sup>+2</sup><sub>-0</sub></td> <td>30±3</td> </tr> <tr> <td>4</td> <td>Room temperature</td> <td>Within 3</td> </tr> </tbody> </table> <p>Number of cycles : 5 cycles Recovery : At least 1hr of recovery under the standard condition after the removal from test chamber, followed by the measurement within 2hrs.</p> <p>LHL · LHF · FB : Accoding to JIS C0025 Conditions for 1 cycle  <table border="1"> <thead> <tr> <th>Step</th> <th>Temperature(°C)</th> <th>Duration(min)</th> </tr> </thead> <tbody> <tr> <td>1</td> <td>Minimum operating temperature<sup>+0</sup><sub>-3</sub></td> <td>30±3</td> </tr> <tr> <td>2</td> <td>Room temperature</td> <td>Within 3</td> </tr> <tr> <td>3</td> <td>Maximum oparating temperature<sup>+2</sup><sub>-0</sub></td> <td>30±3</td> </tr> <tr> <td>4</td> <td>Room temperature</td> <td>Within 3</td> </tr> </tbody> </table> <p>Number of cycles : 10 cycles (LHL□□□, LHF□□BB, LHF15BB) : 5 cycles(FBA, FBR) Recovery : 4 to 24hrs of recovery under the standard condition after the removal from the test cfamber. (LHL□□□, LHF□□BB, LHF15BB) : 3hrs of recovery under the standard condition af- ter the removal from the test cfamber.(FBA, FBR)</p> <p>LAV : Conditions for 1 cycle  <table border="1"> <thead> <tr> <th>Step</th> <th>Temperature(°C)</th> <th>Duration(min)</th> </tr> </thead> <tbody> <tr> <td>1</td> <td>Minimum operating temperature<sup>+0</sup><sub>-3</sub></td> <td>30±3</td> </tr> <tr> <td>2</td> <td>Room temperature</td> <td>Within 3</td> </tr> <tr> <td>3</td> <td>Maximum oparating temperature<sup>+2</sup><sub>-0</sub></td> <td>30±3</td> </tr> <tr> <td>4</td> <td>Room temperature</td> <td>Within 3</td> </tr> </tbody> </table> <p>Number of cycles : 10 cycles Recovery : At least 1hr of recovery under the standard condition after the removal from test chamber, followed by the measurement within 2hrs.</p> <p>FL : Accoding to JIS C0025 Conditions for 1 cycle  <table border="1"> <thead> <tr> <th>Step</th> <th>Temperature(°C)</th> <th>Duration(min)</th> </tr> </thead> <tbody> <tr> <td>1</td> <td>-25<sup>+0</sup><sub>-3</sub></td> <td>30±3</td> </tr> <tr> <td>2</td> <td>Room temperature</td> <td>Within 3</td> </tr> <tr> <td>3</td> <td>+85<sup>+2</sup><sub>-0</sub></td> <td>30±3</td> </tr> <tr> <td>4</td> <td>Room temperature</td> <td>Within 3</td> </tr> </tbody> </table> <p>Number of cycles : 10 cycles Recovery : 1 to 2hrs of recovery under the standard condition after the removal from the test cfamber.</p></p></p></p>	Step	Temperature(°C)	Duration(min)	1	-25 <sup>+0</sup> <sub>-3</sub>	30±3	2	Room temperature	Within 3	3	+85 <sup>+2</sup> <sub>-0</sub>	30±3	4	Room temperature	Within 3	Step	Temperature(°C)	Duration(min)	1	Minimum operating temperature <sup>+0</sup> <sub>-3</sub>	30±3	2	Room temperature	Within 3	3	Maximum oparating temperature <sup>+2</sup> <sub>-0</sub>	30±3	4	Room temperature	Within 3	Step	Temperature(°C)	Duration(min)	1	Minimum operating temperature <sup>+0</sup> <sub>-3</sub>	30±3	2	Room temperature	Within 3	3	Maximum oparating temperature <sup>+2</sup> <sub>-0</sub>	30±3	4	Room temperature	Within 3	Step	Temperature(°C)	Duration(min)	1	-25 <sup>+0</sup> <sub>-3</sub>	30±3	2	Room temperature	Within 3	3	+85 <sup>+2</sup> <sub>-0</sub>	30±3	4	Room temperature	Within 3
Step	Temperature(°C)	Duration(min)																																																																			
1	-25 <sup>+0</sup> <sub>-3</sub>	30±3																																																																			
2	Room temperature	Within 3																																																																			
3	+85 <sup>+2</sup> <sub>-0</sub>	30±3																																																																			
4	Room temperature	Within 3																																																																			
Step	Temperature(°C)	Duration(min)																																																																			
1	Minimum operating temperature <sup>+0</sup> <sub>-3</sub>	30±3																																																																			
2	Room temperature	Within 3																																																																			
3	Maximum oparating temperature <sup>+2</sup> <sub>-0</sub>	30±3																																																																			
4	Room temperature	Within 3																																																																			
Step	Temperature(°C)	Duration(min)																																																																			
1	Minimum operating temperature <sup>+0</sup> <sub>-3</sub>	30±3																																																																			
2	Room temperature	Within 3																																																																			
3	Maximum oparating temperature <sup>+2</sup> <sub>-0</sub>	30±3																																																																			
4	Room temperature	Within 3																																																																			
Step	Temperature(°C)	Duration(min)																																																																			
1	-25 <sup>+0</sup> <sub>-3</sub>	30±3																																																																			
2	Room temperature	Within 3																																																																			
3	+85 <sup>+2</sup> <sub>-0</sub>	30±3																																																																			
4	Room temperature	Within 3																																																																			

Item	Specified Value								Test Method and Remarks
	LA02 Type/ LA03 Type	LA04 Type	LA05 Type	LHL□□□/ LHF15BB/ LHFP□□BB	FBA/FBR	LAV35	FL05□ Type	FL06BT Type	
24.Damp heat	ΔL/L : Within±10% Q : 30min.	ΔL/L : Within±10% ΔQ/Q : Within±30%	ΔL/L : Within±10% Q : 15min.		Appearance : No abnormality Impedance change : Within±20%	ΔL/L : Within±10% Q : 20min.			LA · LAV35 : Temperature : 40±2°C Humidity : 90~95%RH Duration : 1000 hrs Recovery : At least 1hr of recovery under the standard removal from test chamber, followed by the measurement within 2hrs.  FB : Temperature : 60±2°C Humidity : 90~95%RH Duration : 1000 hrs Recovery : 1 to 2hrs of recovery under the standard condition after the removal from the test chamber.
25.Loading under damp heat	ΔL/L : Within±10% Q : 30min.	ΔL/L : Within±10% ΔQ/Q : Within±30%	ΔL/L : Within±10% Q : 15min.	Appearance : No abnormality Inductance change : Within±10% Q change : Within±30%		ΔL/L : Within±10% Q : 20min.	Refer to individual specification	Appearance : No abnormality Impedance change : Within±20%	LA · LAV35 : Temperature : 40±2°C Humidity : 90~95%RH Duration : 1000 hrs Applied current : Rated current Recovery : At least 1hr of recovery under the standard removal from test chamber, followed by the measurement within 2hrs.  LHL · LHF · LHFP : Temperature : 40±2°C Humidity : 90~95%RH Duration : 1000±24 hrs Applied current : Rated current Recovery : 1 to 2hrs of recovery under the standard condition after the removal from the test chamber.  FL : Temperature : 60±3°C Humidity : 90~95%RH Duration : 500 (+12, -0)hrs Applied current : Rated current Recovery : 1 to 2hrs of recovery under the standard condition after the removal from the test chamber.
26.Loading at high temperature	ΔL/L : Within±10% Q : 30min.	ΔL/L : Within±10% ΔQ/Q : Within±30%	ΔL/L : Within±10% Q : 15min.			ΔL/L : Within±10% Q : 20min.			LA · LAV35 : Temperature : 85±2°C Duration : 1000 hrs Applied current : Rated current Recovery : At least 1hr of recovery under the standard removal from test chamber, followed by the measurement within 2hrs.



Item	Specified Value								Test Method and Remarks
	LA02 Type/ LA03 Type	LA04 Type	LA05 Type	LHL□□□/ LHF15BB/ LHFP□□BB	FBA/FBR	LAV35	FL05□ Type	FL06BT Type	
27.Low temperature life test	△L/L : Within±10% Q : 30min.	△L/L : Within±10% △Q/Q : Within±30%	△L/L : Within±10% Q : 15min.	Appearance : No abnormality Inductance change : Within±10% Q change : Within±30%		△L/L : Within±10% Q : 20min.	Refer to individual specification	Appearance : No abnormality Impedance change : Within±20%	LA : Temperature : -25±2°C Duration : 1000 hrs Recovery : At least 1hr of recovery under the standard removal from test chamber, followed by the measurement within 2hrs.  LHL · LHF · LHFP : Temperature : -40±3°C Duration : 1000±24 hrs Recovery : 1 to 2hrs of recovery under the standard condition after the removal from the test chamber.  LAV35 : Temperature : -40±3°C Duration : 1000 hrs Recovery : At least 1hr of recovery under the standard removal from test chamber, followed by the measurement within 2hrs.  FL : Temperature : -40±3°C Duration : 500(+12, -0)hrs Recovery : 1 to 2hrs of recovery under the standard condition after the removal from the test chamber.
28.High temperature life test				Appearance : No abnormality Inductance change : Within±10% Q change : Within±30%			Refer to individual specification	Appearance : No abnormality Impedance change : Within±20%	LHL · LHF · LHFP : Temperature : 105±3°C Duration : 1000±24 hrs Recovery : 1 to 2hrs of recovery under the standard condition after the removal from the test chamber.  FL : Temperature : 85±3°C Duration : 500(+12, -0)hrs Recovery : 1 to 2hrs of recovery under the standard condition after the removal from the test chamber.

# PRECAUTIONS

LA Type, LH Type, FB Type, FL Type

Stages	Precautions	Technical considerations
1.Circuit Design	<p>Operating environment,</p> <p>1.The products described in this specification are intended for use in general electronic equipment,(office supply equipment, telecommunications systems, measuring equipment, and household equipment). They are not intended for use in mission-critical equipment or systems requiring special quality and high reliability (traffic systems, safety equipment, aerospace systems, nuclear control systems and medical equipment including life-support systems,) where product failure might result in loss of life, injury or damage. For such uses, contact TAIYO YUDEN Sales Department in advance.</p>	
2.PCB Design	<p>Design</p> <p>1.Please design insertion pitches of a base in the pitches that fitted a terminal interval.</p>	<p>1.When Inductors are mounted onto a PC board, hole dimensions on the board should match the lead pitch of the component, if not, it will cause breakage of the terminals or cracking of terminal roots covered with resin as excess stress travels through the terminal legs.</p>
3.Considerations for automatic placement	<p>Adjustment of mounting machine</p> <p>1.Excessive impact load should not be imposed on the products when mounting onto the PC boards.</p> <p>2.Mounting and soldering conditions should be checked beforehand.</p>	<p>1. When installing products, care should be taken not to apply distortion stress as it may deform the products.</p>
4.Soldering	<p>Wave soldering</p> <p>1.Please refer to the specifications in the catalog for a wave soldering.</p> <p>2.Do not immerse the entire Inductors in the flux during the soldering operation.</p> <p>Lead free soldering</p> <p>1.When using products with lead free soldering, we request to use them after confirming of adhesion, temperature of resistance to soldering heat, soldering etc sufficiently.</p> <p>Recommended conditions for using a soldering iron: Put the soldering iron on the land-pattern. Soldering iron's temperature - Below 350 °C Duration - 3 seconds or less The soldering iron should not directly touch the inductor.</p>	<p>1.If products are used beyond the range of the recommended conditions, heat stresses may deform the products, and consequently degrade the reliability of the products.</p>
5.Cleaning	<p>Cleaning conditions</p> <p>1.LA type, LH type Please do not do cleaning by a supersonic wave.</p>	<p>LA type, LH type</p> <p>1.If washing by supersonic waves, supersonic waves may deform products.</p>
6.Handling	<p>Handling</p> <p>1.Keep the inductors away from all magnets and magnetic objects.</p> <p>Mechanical considerations</p> <p>1.Please do not give the inductors any excessive mechanical shocks.</p> <p>2.LH type If inductors are dropped onto the floor or a hard surface they should not be used.</p> <p>Packing</p> <p>1.Please do not give the inductors any excessive mechanical shocks.</p> <p>In loading, please pay attention to handling indication mentioned in a packing box (a loading direction / number of maximum loading / fragile item).</p>	<p>1.There is a case that a characteristic varies with magnetic influence.</p> <p>1.There is a case to be damaged by a mechanical shock.</p> <p>2.LH type There is a case to be broken by a fall.</p> <p>1.There is a case that a lead route turns at by a fall or an excessive shock.</p>
7.Storage conditions	<p>Storage</p> <p>Storage</p> <p>1.To maintain the solderability of terminal electrodes and to keep the packing material in good condition, temperature and humidity in the storage area should be controlled..</p> <p>• Recommended conditions</p> <p>Ambient temperature           0~40°C</p> <p>Humidity                        Below 70 % RH</p> <p>The ambient temperature must be kept below 30°C. Even under ideal storage conditions, solderability of products electrodes may decrease as time passes. For this reason, inductors should be used within one year from the time of delivery.</p> <p>In case of storage over 6 months, solderability shall be checked before actual usage.</p>	<p>1. Under a high temperature and humidity environment, problems such as reduced solderability caused by oxidation of terminal electrodes and deterioration of taping/package materials may take place.</p>