



LIGITEK

www.DataSheet4U.com

LIGITEK ELECTRONICS CO.,LTD.  
Property of Ligitek Only

---

INFRARED EMITTING DIODES



Lead-Free Parts

LHIR2342-PF

# DATA SHEET

DOC. NO : QW0905-LHIR2342-PF

REV. : A

DATE : 10 - Jul. - 2008



### Package Dimensions

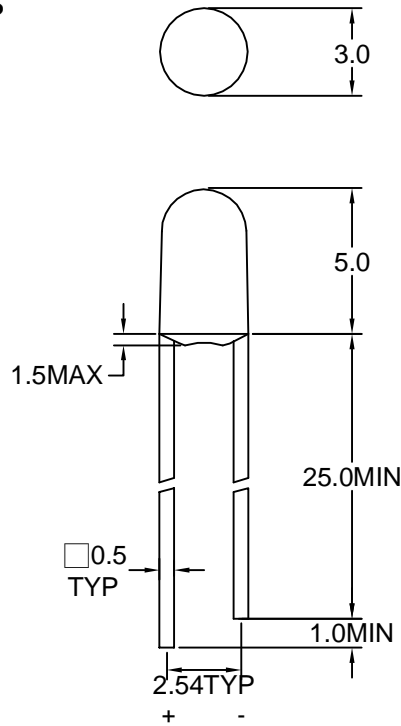

Note : 1.All dimension are in millimeter tolerance is  $\pm 0.25\text{mm}$  unless otherwise noted.  
 2.Specifications are subject to change without notice.

### Features:

1. High radiant intensity.
2. Suitable for pulsed applications.
3. Low average degradation.

### Descriptions:

emitting diodes encapsulated in white diffused plastic T-1 package individually  
 The LHIR2042/S78-PF series are super-high efficiency Gallium Aluminum Arsenide infrared

### Device Selection Guide:

PART NO	MATERIAL	LENS COLOR
LHIR2342-PF	GaAlAs	White Diffused

**Absolute Maximum Ratings at Ta=25 °C**

Parameter	Symbol	Ratings	UNIT
		HIR	
Forward Current	IF	50	mA
Peak Forward Current (300PPS, 1 μs Pulse)	IFP	3	A
Power Dissipation	PD	100	mW
Reverse Voltage	Vr	5	V
Electrostatic Discharge	ESD	2000	V
Operating Temperature	Topr	-40 ~ +85	°C
Storage Temperature	Tstg	-40 ~ +85	°C

**Electrical Optical Characteristics (Aa=25°C)**

PARAMETER	SYMBOL	Min.	Typ.	Max.	UNIT	TEST CONDITION
Radiant Intensity	Le	4.5	8.0		mW/sr	IF=20mA
Aperture Radiant Incidence	Ee	0.34	0.57		mW/cm <sup>2</sup>	IF=20mA
Peak Emission Wavelength	λ peak		850		nm	IF=20mA
Spectral Line Half Width	Δλ		50		nm	IF=20mA
Forward Voltage	VF		1.2	1.6	V	IF=20mA
Reverse Current	IR			100	μA	VR=5V
Viewing Angle	2θ 1/2		58		deg	

Note : 1. The forward voltage data did not including ±0.1V testing tolerance.

2. The radiant intensity data did not including ±15% testing tolerance.



### Typical Electro-Optical Characteristics Curve

HIR CHIP

Fig.1 Forward Current vs. Forward Voltage

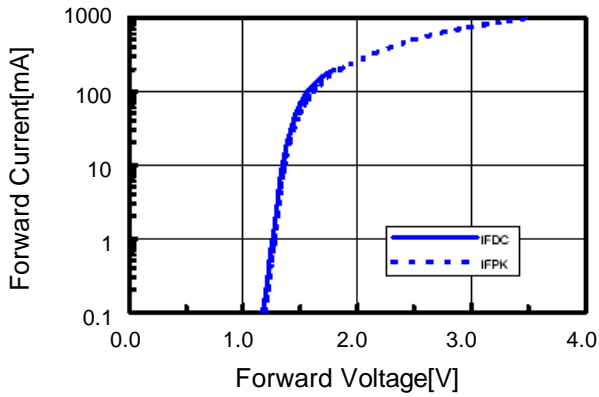

Fig.2 Relative Radiant Power vs. Wavelength

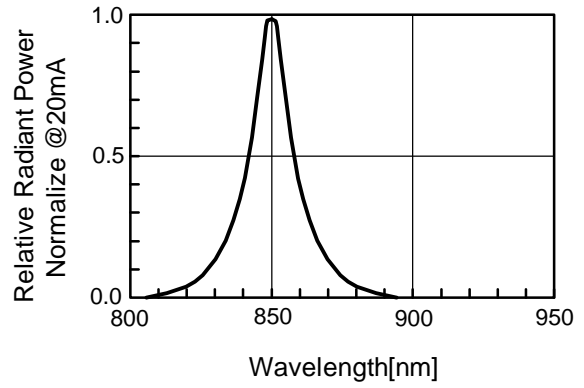

Fig.3 Relative Radiant Power vs. Forward DC Current

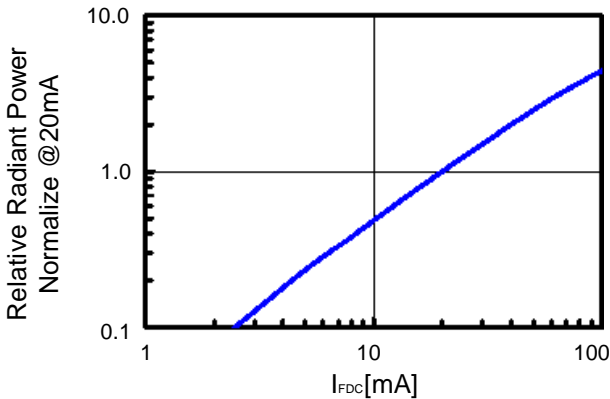

Fig.4 Relative Radiant Power vs. Forward Peak Current

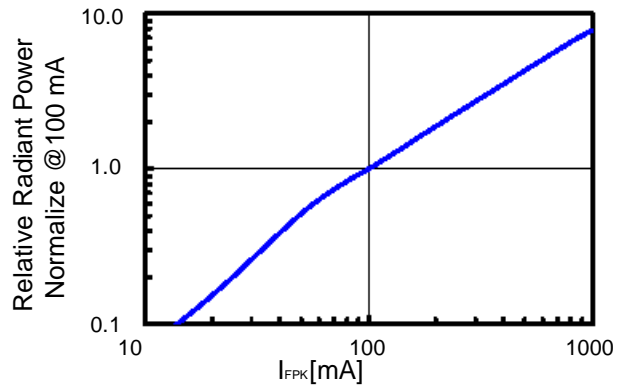

Fig.5 Forward DC Voltage vs. Temperature

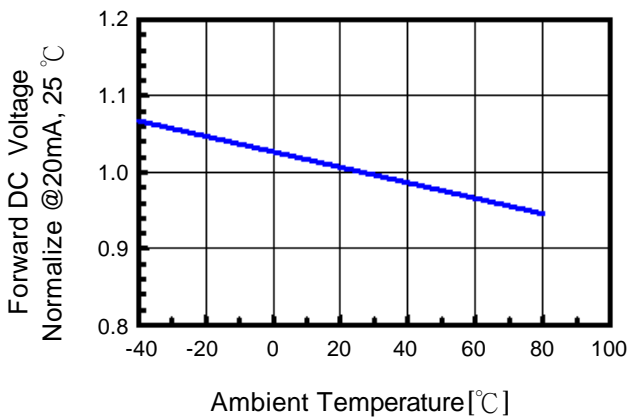
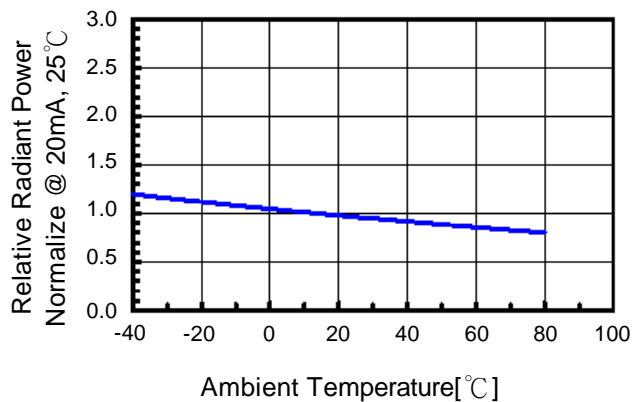

Fig.6 Relative Radiant Power vs. Temperature





### Soldering Condition(Pb-Free)

#### 1.Iron:

- Soldering Iron:30W Max
- Temperature 350 ° C Max
- Soldering Time:3 Seconds Max(One time only)
- Distance:2mm Min(From solder joint to body)

#### 2.Wave Soldering Profile

- Dip Soldering
- Preheat: 120° C Max
- Preheat time: 60seconds Max
- Ramp-up
- 2° C/sec(max)
- Ramp-Down:-5° C/sec(max)
- Solder Bath:260° C Max
- Dipping Time:3 seconds Max
- Distance:2mm Min(From solder joint to body)

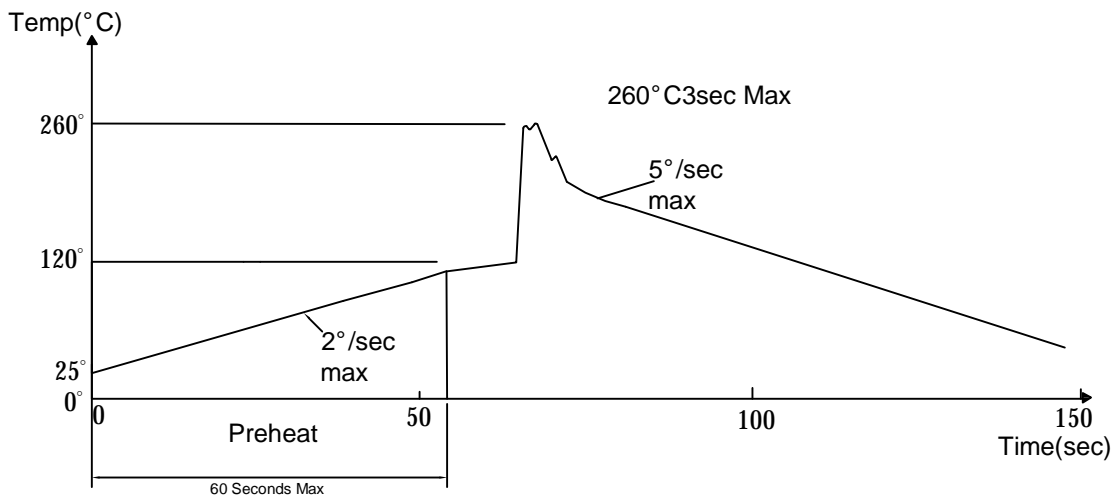

Note: 1.Wave solder should not be made more than one time.  
2.You can just only select one of the soldering conditions as above.



Reliability Test:

Test Item	Test Condition	Description	Reference Standard
Operating Life Test	1.Under Room Temperature 2.If=20mA 3.t=1000 hrs (-24hrs, +72hrs)	This test is conducted for the purpose of determining the resistance of a part in electrical and thermal stressed.	MIL-STD-750: 1026 MIL-STD-883: 1005 JIS C 7021: B-1
High Temperature Storage Test	1.Ta=85°C±5°C 2.t=1000 hrs (-24hrs, +72hrs)	The purpose of this is the resistance of the device which is laid under condition of high temperature for hours.	MIL-STD-883:1008 JIS C 7021: B-10
Low Temperature Storage Test	1.Ta=-40°C±5°C 2.t=1000 hrs (-24hrs, +72hrs)	The purpose of this is the resistance of the device which is laid under condition of low temperature for hours.	JIS C 7021: B-12
High Temperature High Humidity Test	1.Ta=65°C±5°C 2.RH=90%~95% 3.t=240hrs±2hrs	The purpose of this test is the resistance of the device under tropical for hours.	MIL-STD-202:103B JIS C 7021: B-11
Thermal Shock Test	1.Ta=105°C±5°C&-40°C±5°C (10min) (10min) 2.total 10 cycles	The purpose of this is the resistance of the device to sudden extreme changes in high and low temperature.	MIL-STD-202: 107D MIL-STD-750: 1051 MIL-STD-883: 1011
Solder Resistance Test	1.T.Sol=260°C±5°C 2.Dwell time= 10±1sec.	This test intended to determine the thermal characteristic resistance of the device to sudden exposures at extreme changes in temperature when soldering the lead wire.	MIL-STD-202: 210A MIL-STD-750: 2031 JIS C 7021: A-1
Solderability Test	1.T.Sol=230°C±5°C 2.Dwell time=5±1sec	This test intended to see soldering well performed or not.	MIL-STD-202: 208D MIL-STD-750: 2026 MIL-STD-883: 2003 JIS C 7021: A-2