

PREPARED BY: _____	DATE _____	SHARP	SPEC No. LD-K21Z19
APPROVED BY: _____	DATE _____		FILE No.
			ISSUE: December, 10, 2009
			PAGE : 24 pages
		AVC LIQUID CRYSTAL DISPLAY GROUP SHARP CORPORATION	APPLICABLE GROUP AVC LIQUID CRYSTAL DISPLAY GROUP
		SPECIFICATION	

DEVICE SPECIFICATION FOR

TFT - LCD module

MODEL No. LK315D3LA57

CUSTOMER'S APPROVAL

DATE _____

BY _____

PRESENTED

BY  _____

T. SUZUKI

GENERAL MANAGER

MODULE DEVELOPMENT CENTER

AVC LIQUID CRYSTAL DISPLAY GROUP

SHARP CORPORATION

1. Application

This specification applies to the color 31.5" TFT-LCD module LK315D3LA57

- * These specifications are proprietary products of SHARP CORPORATION ("SHARP") and include materials protected under copyright of SHARP. Do not reproduce or cause any third party to reproduce them in any form or by any means, electronic or mechanical, for any purpose, in whole or in part, without the express written permission of SHARP.
- * In case of using the device for applications such as control and safety equipment for transportation (aircraft, trains, automobiles, etc.), rescue and security equipment and various safety related equipment which require higher reliability and safety, take into consideration that appropriate measures such as fail-safe functions and redundant system design should be taken.
- * Do not use the device for equipment that requires an extreme level of reliability, such as aerospace applications, telecommunication equipment (trunk lines), nuclear power control equipment and medical or other equipment for life support.
- * SHARP assumes no responsibility for any damage resulting from the use of the device that does not comply with the instructions and the precautions specified in these specifications.
- * Contact and consult with a SHARP sales representative for any questions about this device.

2. Overview

This module is a color active matrix LCD module incorporating amorphous silicon TFT (Thin Film Transistor). It is composed of a color TFT-LCD panel, driver ICs, control circuit, power supply circuit, balancer circuit and back light system etc. Graphics and texts can be displayed on a 1920×RGB×1080 dots panel 8bit+2FRC LVDS (Low Voltage Differential Signaling) to interface, +12V of DC supply voltages.

This module also includes the balancer board. (Circuit for balancing of CCFT current)

And in order to improve the response time of LCD, this module applies the Over Shoot driving (O/S driving) technology for the control circuit. In the O/S driving technology, signals are being applied to the Liquid Crystal according to a pre-fixed process as an image signal of the present frame when a difference is found between image signal of the previous frame and that of the current frame after comparing them.

With this technology, image signals can be set so that liquid crystal response completes within one frame. As a result, motion blur reduces and clearer display performance can be realized.

This LCD module also adopts Double Frame Rate driving method.

With combination of these technologies, motion blur can be reduced and clearer display performance can be realized.

3. Mechanical Specifications

Parameter	Specifications	Unit
Display size	80.039 (Diagonal)	cm
	31.5 (Diagonal)	inch
Active area	698.40 (H) × 392.85 (V)	mm
Pixel Format	1920(H) x 1080(V) (1pixel = R + G + B dot)	pixel
Pixel pitch	0.36375(H) x 0.36375 (V)	mm
Pixel configuration	R, G, B vertical stripe	
Display mode	Normally black	
Unit Outline Dimensions (*1)	760.0(W) x 450.0(H) x 50.0(D) * Excluding protruding portion	mm
Mass	5.0kg ± 0.5kg	kg
Surface treatment	Half glare Hard coating: (3H)	

(*1) Outline dimensions are shown in Fig.1 (excluding protruding portion)

4. Input Terminals

4.1. TFT panel driving

CN1 (Interface signals and +12V DC power supply) (Shown in Fig.1)

Using connector : FI-RE51S-HF (Japan Aviation Electronics Ind., Ltd.)

Mating connector : FI-RE51HL, FI-RE51CL (Japan Aviation Electronics Ind., Ltd.)

Mating LVDS transmitter : THC63LVD1023 or equivalent device

Pin No.	Symbol	Function	Remark
1	GND		
2	Reserved	It is required to set non-connection(OPEN)	Pull up 3.3V
3	Reserved	It is required to set non-connection(OPEN)	Pull up 3.3V
4	Reserved	It is required to set non-connection(OPEN)	Pull up 3.3V
5	FRAME	Frame frequency setting 1:120Hz 0:100Hz [Note 1]	Default :Pull down (GND)
6	O/S set	O/S operation setting H:O/S_ON, L:O/S_OFF [Note 3]	Default :Pull up (3.3V)
7	SELLVDS	Select LVDS data order [Note 1] [Note 2]	Default :Pull down (GND)
8	Reserved	It is required to set non-connection(OPEN)	Pull down : (GND)
9	Reserved	It is required to set non-connection(OPEN)	Pull down : (GND)
10	Reserved	It is required to set non-connection(OPEN)	Pull down : (GND)
11	GND		
12	AIN0-	Aport (-)LVDS CH0 differential data input	
13	AIN0+	Aport (+)LVDS CH0 differential data input	
14	AIN1-	Aport (-)LVDS CH1 differential data input	
15	AIN1+	Aport (+)LVDS CH1 differential data input	
16	AIN2-	Aport (-)LVDS CH2 differential data input	
17	AIN2+	Aport (+)LVDS CH2 differential data input	
18	GND		
19	ACK-	Aport LVDS Clock signal(-)	
20	ACK+	Aport LVDS Clock signal(+)	
21	GND		
22	AIN3-	Aport (-)LVDS CH3 differential data input	
23	AIN3+	Aport (+)LVDS CH3 differential data input	
24	AIN4-	Aport (-)LVDS CH4 differential data input	
25	AIN4+	Aport (+)LVDS CH4 differential data input	
26	GND		
27	GND		
28	BIN0-	Bport (-)LVDS CH0 differential data input	
29	BIN0+	Bport (+)LVDS CH0 differential data input	
30	BIN1-	Bport (-)LVDS CH1 differential data input	
31	BIN1+	Bport (+)LVDS CH1 differential data input	
32	BIN2-	Bport (-)LVDS CH2 differential data input	
33	BIN2+	Bport (+)LVDS CH2 differential data input	
34	GND		
35	BCK-	Bport LVDS Clock signal(-)	
36	BCK+	Bport LVDS Clock signal(+)	
37	GND		
38	BIN3-	Bport (-)LVDS CH3 differential data input	
39	BIN3+	Bport (+)LVDS CH3 differential data input	
40	BIN4-	Bport (-)LVDS CH4 differential data input	
41	BIN4+	Bport (+)LVDS CH4 differential data input	
42	GND		
43	GND		
44	GND		
45	GND		
46	GND		
47	Reserved (VCC)	(+12V Power Supply)	
48	VCC	+12V Power Supply	
49	VCC	+12V Power Supply	
50	VCC	+12V Power Supply	
51	VCC	+12V Power Supply	

CN2 (Interface signals) (Shown in Fig1)

Using connector : FI-RE41S-HF (Japan Aviation Electronics Ind., Ltd.)

Mating connector : FI-RE41HL, FI-RE41CL (Japan Aviation Electronics Ind., Ltd.)

Pin No.	Symbol	Function	Remark
1	Reserved (VCC)	(+12V Power Supply)	
2	Reserved (VCC)	(+12V Power Supply)	
3	Reserved (VCC)	(+12V Power Supply)	
4	Reserved (VCC)	(+12V Power Supply)	
5	Reserved		
6	Reserved		
7	Reserved		
8	Reserved		
9	GND		
10	CIN0-	Cport (-)LVDS CH0 differential data input	
11	CIN0+	Cport (+)LVDS CH0 differential data input	
12	CIN1-	Cport (-)LVDS CH1 differential data input	
13	CIN1+	Cport (+)LVDS CH1 differential data input	
14	CIN2-	Cport (-)LVDS CH2 differential data input	
15	CIN2+	Cport (+)LVDS CH2 differential data input	
16	GND		
17	CCK-	Cport LVDS Clock signal(-)	
18	CCK+	Cport LVDS Clock signal(+)	
19	GND		
20	CIN3-	Cport (-)LVDS CH3 differential data input	
21	CIN3+	Cport (+)LVDS CH3 differential data input	
22	CIN4-	Cport (-)LVDS CH4 differential data input	
23	CIN4+	Cport (+)LVDS CH4 differential data input	
24	GND		
25	GND		
26	DIN0-	Dport (-)LVDS CH0 differential data input	
27	DIN0+	Dport (+)LVDS CH0 differential data input	
28	DIN1-	Dport (-)LVDS CH1 differential data input	
29	DIN1+	Dport (+)LVDS CH1 differential data input	
30	DIN2-	Dport (-)LVDS CH2 differential data input	
31	DIN2+	Dport (+)LVDS CH2 differential data input	
32	GND		
33	DCK-	Dport LVDS Clock signal(-)	
34	DCK+	Dport LVDS Clock signal(+)	
35	GND		
36	DIN3-	Dport (-)LVDS CH3 differential data input	
37	DIN3+	Dport (+)LVDS CH3 differential data input	
38	DIN4-	Dport (-)LVDS CH4 differential data input	
39	DIN4+	Dport (+)LVDS CH4 differential data input	
40	GND		
41	GND		

[Note] GND of a liquid crystal panel drive part has connected with a module chassis.

[Note 1] The equivalent circuit figure of the terminal

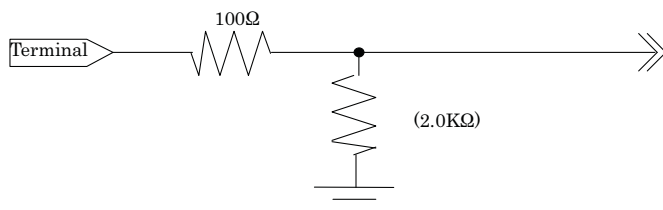

[Note 2] LVDS Data order

SELLVDS		
Data	L(GND) or Open [VESA]	H(3.3V) [JEIDA]
TA0	R0(LSB)	R4
TA1	R1	R5
TA2	R2	R6
TA3	R3	R7
TA4	R4	R8
TA5	R5	R9(MSB)
TA6	G0(LSB)	G4
TB0	G1	G5
TB1	G2	G6
TB2	G3	G7
TB3	G4	G8
TB4	G5	G9(MSB)
TB5	B0(LSB)	B4
TB6	B1	B5
TC0	B2	B6
TC1	B3	B7
TC2	B4	B8
TC3	B5	B9(MSB)
TC4	NA	NA
TC5	NA	NA
TC6	DE(*)	DE(*)
TD0	R6	R2
TD1	R7	R3
TD2	G6	G2
TD3	G7	G3
TD4	B6	B2
TD5	B7	B3
TD6	N/A	N/A
TE0	R8	R0(LSB)
TE1	R9(MSB)	R1
TE2	G8	G0(LSB)
TE3	G9(MSB)	G1
TE4	B8	B0(LSB)
TE5	B9(MSB)	B1
TE6	N/A	N/A

NA: Not Available

(*) Since the display position is prescribed by the rise of DE(Display Enable) signal, please do not fix DE signal during operation at "High".

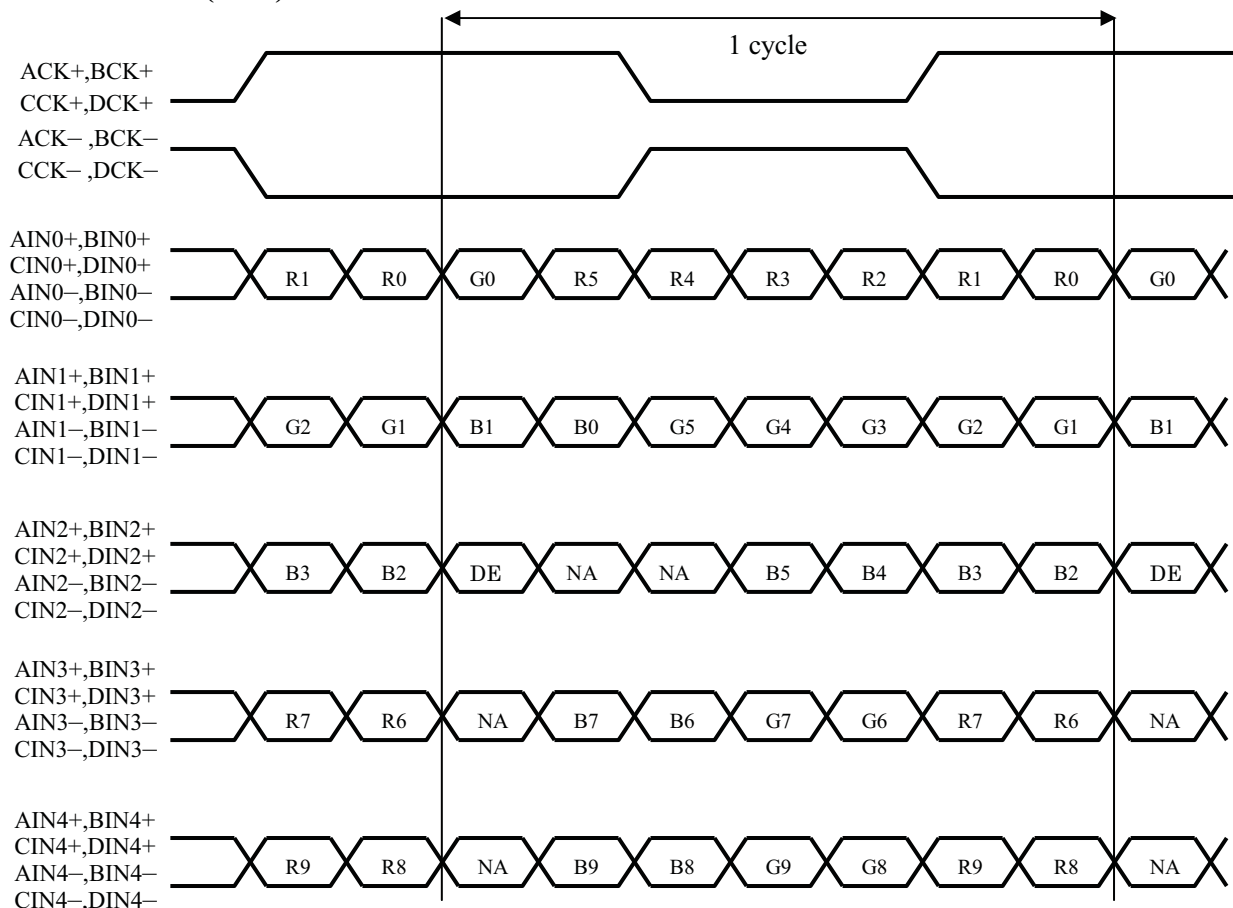
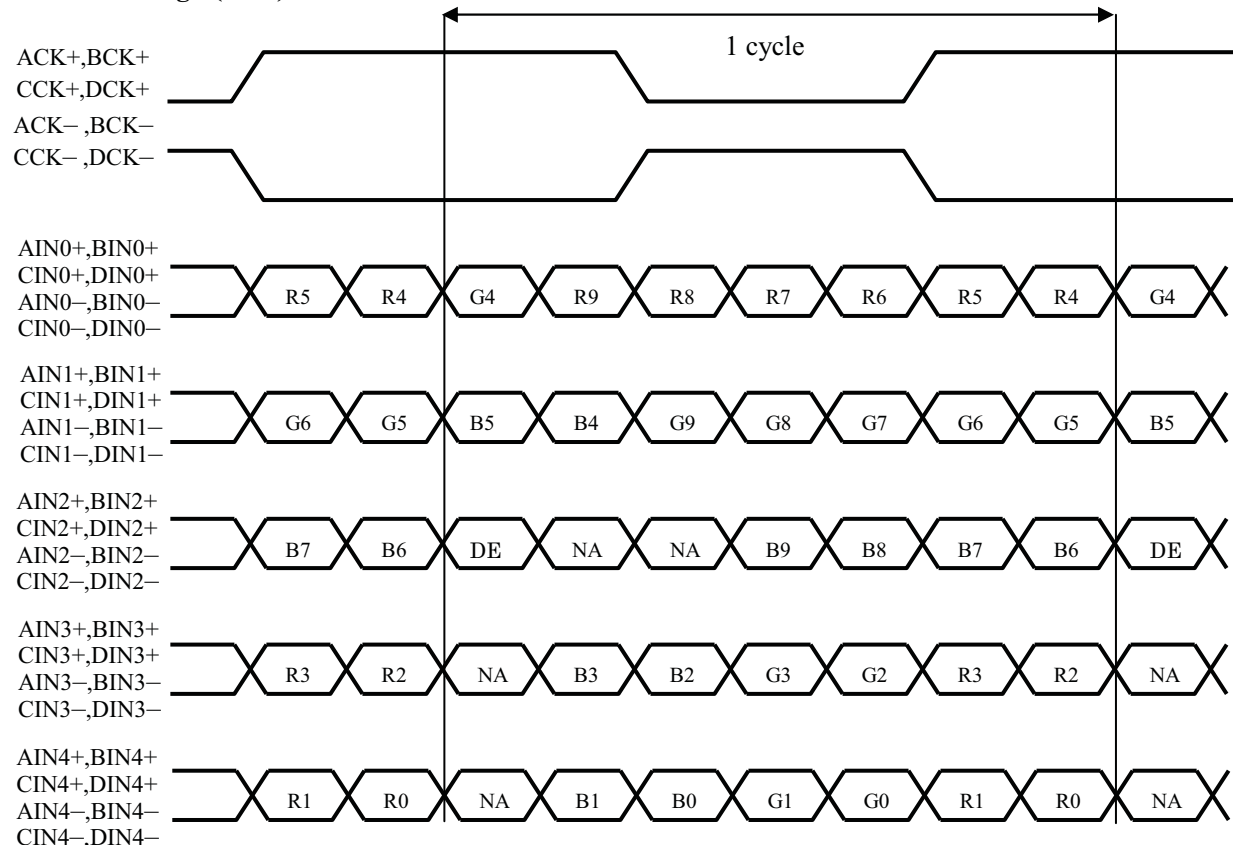
SELLVDS= Low (GND) or OPEN**SELLVDS= High (3.3V)**

DE: Display Enable, NA: Not Available (Fixed Low)

[Note 3] The equivalent circuit figure of the terminal

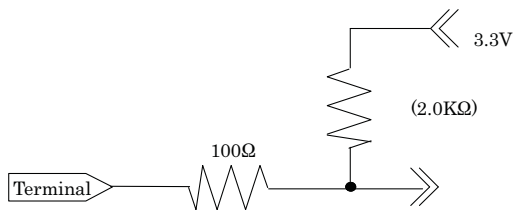

4.2. Balancer board

CN101 (High Voltage Input)

Using connector: 35001HS-02L(YeonHo)/Mating connector ; 35002WS-02L(YeonHo)

Pin No.	Symbol	Function	Remark
1	HV1	High voltage input (+)	
2	FB	N.C.	

CN102 (High Voltage Input)

Using connector: 65002WS-03L(YeonHo)/Mating connector ; 65002HS-03L(YeonHo)

Pin No.	Symbol	Function	Remark
1	HV2	High voltage input (-)	
2	HV2	High voltage input (-)	
3	FB	N.C.	

4.3. Interface block diagram

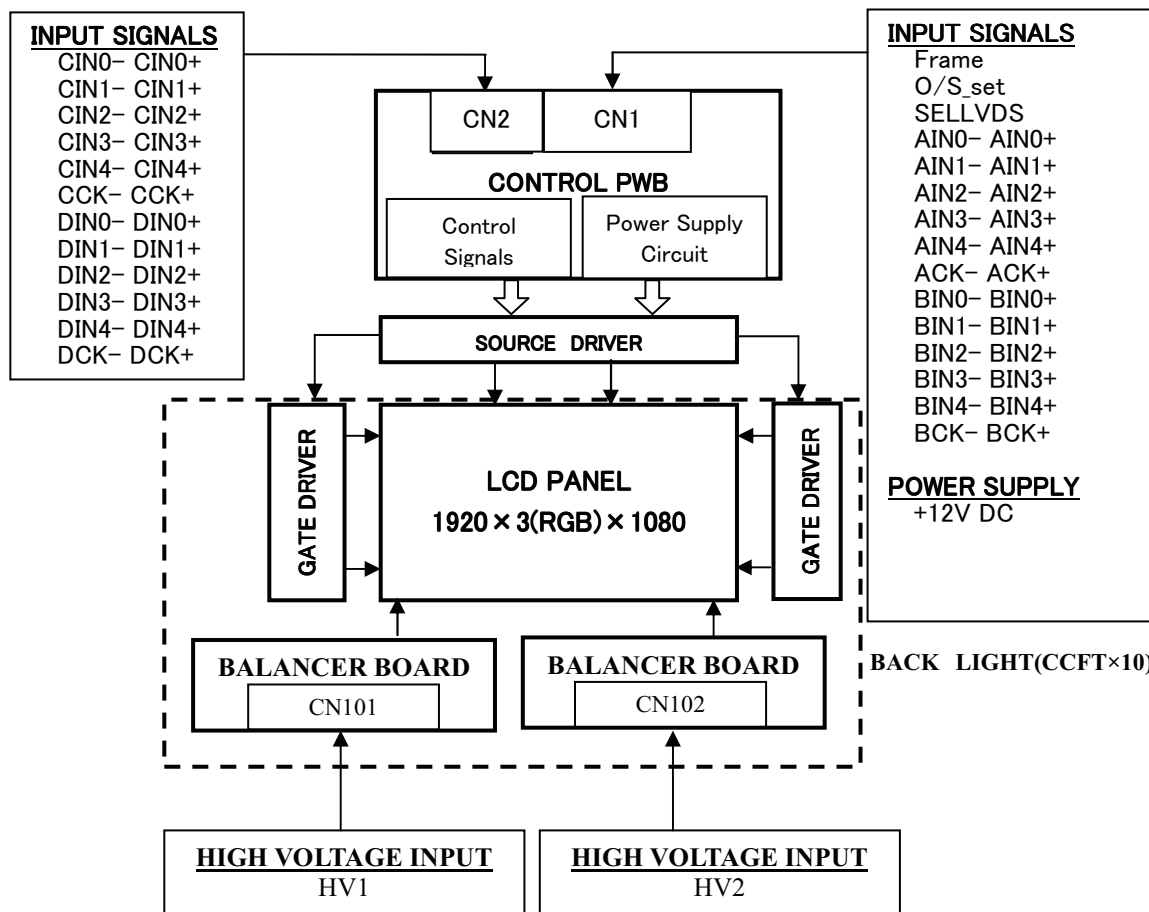

4.4. Equivalent circuit of backlight unit

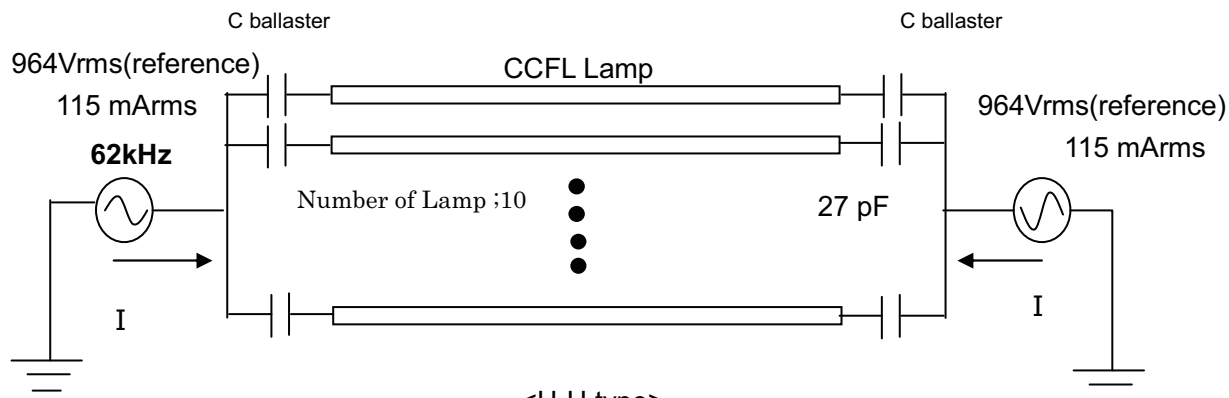

<H-H type>

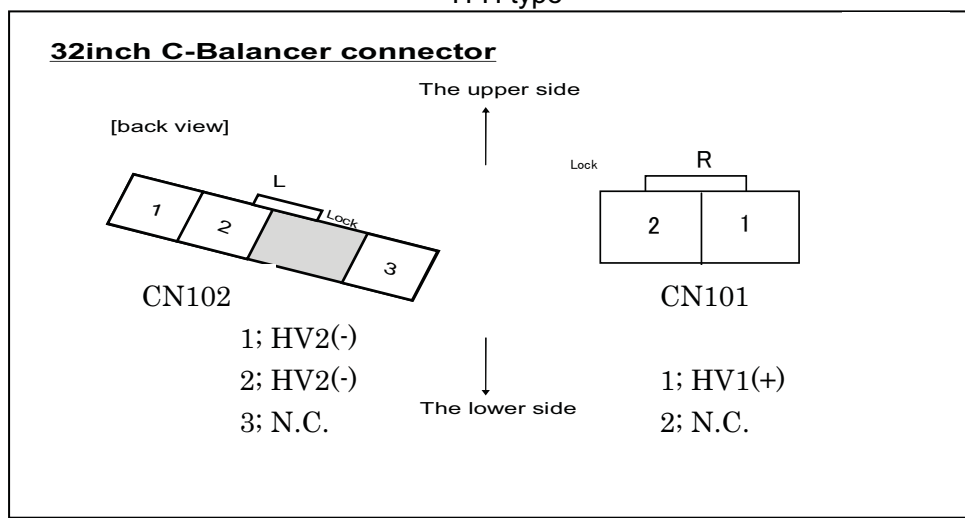

- *1 : •Lamp life time is defined as the time when brightness becomes 50% of the original value in the continuous operation under the condition of Ta=25 °C.
- Above value is applicable when the long side of LCD module is placed horizontally.(Landscape position).
(Lamp lifetime may vary if LCD module is in portrait position due to the change of mercury density inside the lamp.)
- *2 : •Dimming range(=On Time/All Time) is 10%-100%. It is based on the condition that lamp current amplitude is 100% all time.

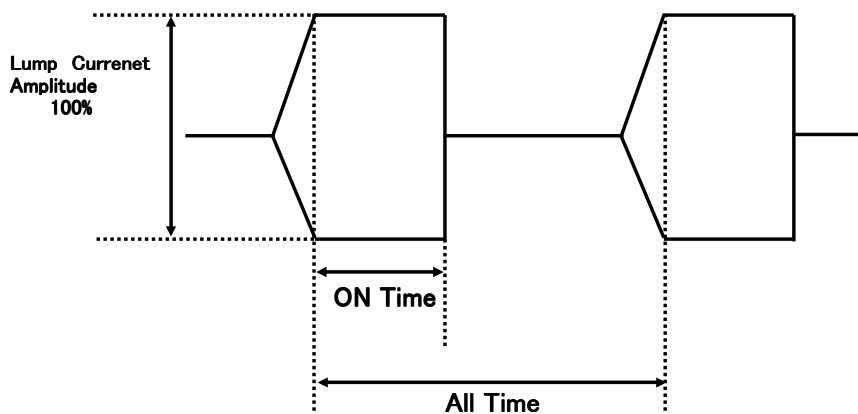

4.5 The back light system characteristics

The back light system is direct type with 10 CCFTs (Cold Cathode Fluorescent Tube).

The characteristics of the lamp are shown in the following table.

BLU assembly condition

Description		Min	Typ	Max	Unit	Condition	Note	
1	BLU Voltage (reference value)	$V_{BL(L)}$	764	964	1,164	V_{rms}	left side of back view, $f_{BL}=62kHz$, $I_{BL(L)}=115mA_{rms}$, $C_B=27pF$ at LG IPB, $t=25^{\circ}C \pm 2^{\circ}C$, Duty=100% more than 60min after turn on.	This value is not guaranteed.
		$V_{BL(R)}$	765	965	1,165		right side of back view, $f_{BL}=62kHz$, $I_{BL(R)}=122mA_{rms}$, $C_B=27pF$ at LG IPB, $t=25^{\circ}C \pm 2^{\circ}C$, Duty=100% more than 60min after turn on.	
2	BLU Current	$I_{BL(L)}$	105	115	125	mA_{rms}	left side of back view, $f_{BL}=62kHz$, $C_B=27pF$ at SHARP IPB, $t=25^{\circ}C \pm 2^{\circ}C$, Duty=100% more than 60min after turn on.	
		$I_{BL(R)}$	112	122	132		right side of back view, $f_{BL}=62kHz$, $C_B=27pF$ at SHARP IPB, $t=25^{\circ}C \pm 2^{\circ}C$, Duty=100% more than 60min after turn on.	
3	BLU Total Power	P_O	85	95	105	W	$f_{BL}=62kHz$, $I_{BL(L)}=115mA_{rms}$, $I_{BL(R)}=122mA_{rms}$, $C_B=27pF$ at SHARP IPB, $t=25^{\circ}C \pm 2^{\circ}C$, Duty=100% more than 60min after turn on.	
4	Striking Voltage	V_S	-	-	1,265	V_{rms}	At 25°C / one side	not exceed absolute maximum ratings (2,500V _{rms})
			-	-	1,270		At 0°C / one side	
5	Lamp frequency	f_{BL}	59	62	65	kHz		
6	Striking time	T_S	-	-	1	sec		
7	Lamp Type		CCFL					
8	Number of lamps		10			Pcs		
9	Type of current balance		C type					
10	C ballaster	C_B	26	27	28	pF	$t=25^{\circ}C \pm 2^{\circ}C$	
11	Life Time		50,000	-	-	Hrs		*1
12	PWM dimming on duty	PWM duty	20	-	100	%	pulse input (at SHARP IPB)	
13	BLU current on duty	I_{BL} duty	10	-	100	%		*2
14	PWM dimming frequency	f_{PWM}	90	-	350	Hz		

Pure lamp components specification

Description		Min	Typ	Max	Unit	Condition	Note
1	Lamp Voltage	V_{lamp}	755	795	835	V_{rms}	($I_L=11.5mA_{rms}$)
2	Lamp Current	I_{lamp}	7	-	12.5	mA_{rms}	
3	Lamp frequency	f_L	30	40	70	kHz	
4	Striking Voltage	V_{Slamp}	-	-	1,050	V_{rms}	At 25°C
			-	-	1,260		At 0°C
5	Striking time	T_{Slamp}	-	-	1	sec	

5. Absolute Maximum Ratings

Parameter	Symbol	Condition	Ratings	Unit	Remark
Input voltage (for Control)	VI	Ta=25 °C	-0.3 ~ 3.6	V	[Note 1]
12V supply voltage (for Control)	VCC	Ta=25 °C	0 ~ + 14	V	
Input high voltage (for balancer board)	HV1,HV2	Ta=25 °C	2500	V_{rms}	
Storage temperature	Tstg	-	-25 ~ +60	°C	[Note 2]
Operation temperature (Ambient)	Topa	-	0 ~ +50	°C	

[Note 1] SELLVDS, FRAME, O/S_set,

[Note 2] Humidity 95%RH Max.(Ta ≤ 40°C)

Maximum wet-bulb temperature at 39 °C or less.(Ta > 40°C)

No condensation.

6. Electrical Characteristics

6.1. Control circuit driving

Ta=25 °C

Parameter	Symbol	Min.	Typ.	Max.	Unit	Remark	
+12V supply voltage	Supply voltage	Vcc	11.4	12	12.6	V	[Note 1]
	Current dissipation	Icc	-	660	2000	mA	[Note 2]
	Inrush current	I _{RUSH}	-	5.8	-	A	t1=500us [Note 7]
Permissible input ripple voltage	VRP	-	-	100	mVP-P	Vcc = +12.0V	
Input Low voltage	VIL	0	-	1.0	V	[Note 3]	
Input High voltage	VIH	2.3	-	3.3	V		
Input leak current (Low)	IIL1	-	-	400	μA	VI = 0V [Note 4]	
	IIL2	-	-	40	μA	VI = 0V [Note 5]	
Input leak current (High)	IHH1	-	-	40	μA	VI = 3.3V [Note 4]	
	IHH2	-	-	400	μA	VI = 3.3V [Note 5]	
Terminal resistor	RT	-	100	-	Ω	Differential input	
Input Differential voltage	VID	200	400	600	mV	[Note 6]	
Differential input common mode voltage	VCM	VID /2	1.2	2.4- VID /2	V	[Note 6]	

[Note]VCM: Common mode voltage of LVDS driver.

[Note 1]

Input voltage sequences

$$0 < t1 < 20\text{ms}$$

$$20\text{ms} < t2 < 5\text{s}$$

$$20\text{ms} < t3 < 5\text{s}$$

$$0 < t4 < 1\text{s}$$

$$t5-1 > 1\text{s}$$

$$t5-2 > 1\text{s}$$

$$t6-1 > 0$$

$$t6-2 > 0$$

$$t7 > 1\text{s}$$

Dip conditions for supply voltage

$$\text{a) } 9.1\text{V} \leq V_{cc} < 10.8\text{V}$$

$$t_d < 10\text{ms}$$

$$\text{b) } V_{cc} < 9.1\text{V}$$

Dip conditions for supply voltage is based on input voltage sequence.

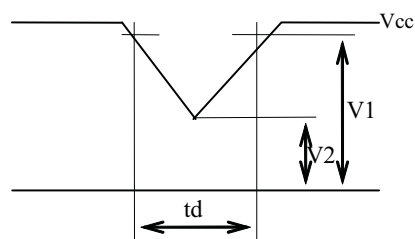
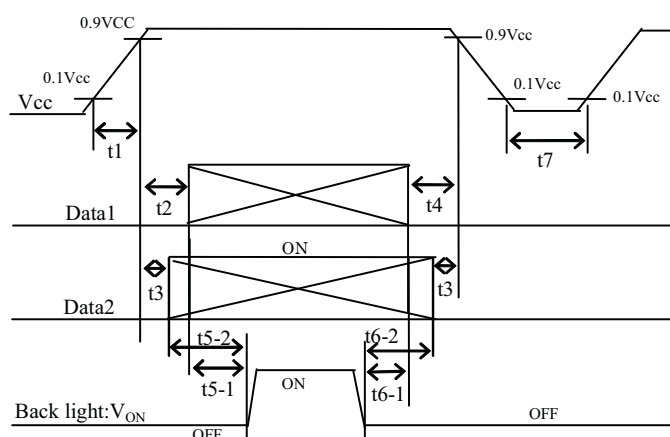

- ※ Data1: ACK±, AIN0±, AIN1±, AIN2±, AIN3±, AIN4±, BCK±, BIN0±, BIN1±, BIN2±, BIN3±, BIN4±
CCK±, CIN0±, CIN1±, CIN2±, CIN3±, CIN4±, DCK±, DIN0±, DIN1±, DIN2±, DIN3±, DIN4±
*V_{CM} voltage pursues the sequence mentioned above
- ※ Data2: SELLVDS, FRAME, O/S_SET

[Note] About the relation between data input and back light lighting, please base on the above-mentioned input sequence. When back light is switched on before panel operation or after a panel operation stop, it may not display normally. But this phenomenon is not based on change of an incoming signal, and does not give damage to a liquid crystal display.

[Note 2] Typical current situation: 1024 gray-bar patterns. (V_{cc} = +12.0V)

The explanation of RGB gray scale is seen in section 8.

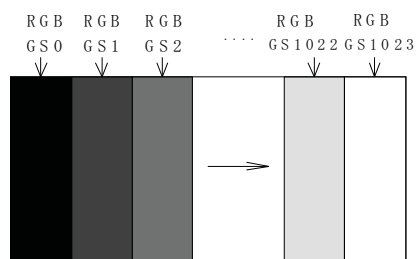

V_{cc} = +12.0V
CK = 74.25MHz
Th = 7.41μs

[Note 3] SELLVDS, FRAME, O/S_SET

[Note 4] O/S_SET

[Note 5] FRAME, SELLVDS

[Note 6] ACK±, AIN0±, AIN1±, AIN2±, AIN3±, AIN4±, BCK±, BIN0±, BIN1±, BIN2±, BIN3±, BIN4±
CCK±, CIN0±, CIN1±, CIN2±, CIN3±, CIN4±, DCK±, DIN0±, DIN1±, DIN2±, BDIN3±, DIN4±

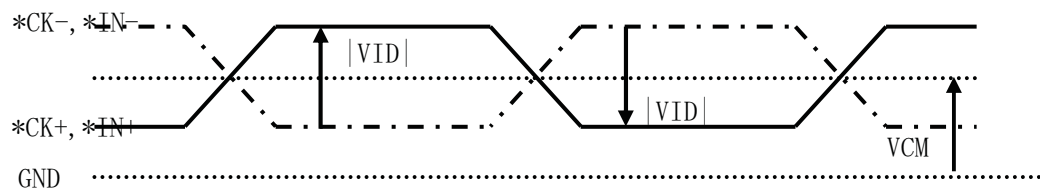

[Note 7] Vcc12V inrush current waveform

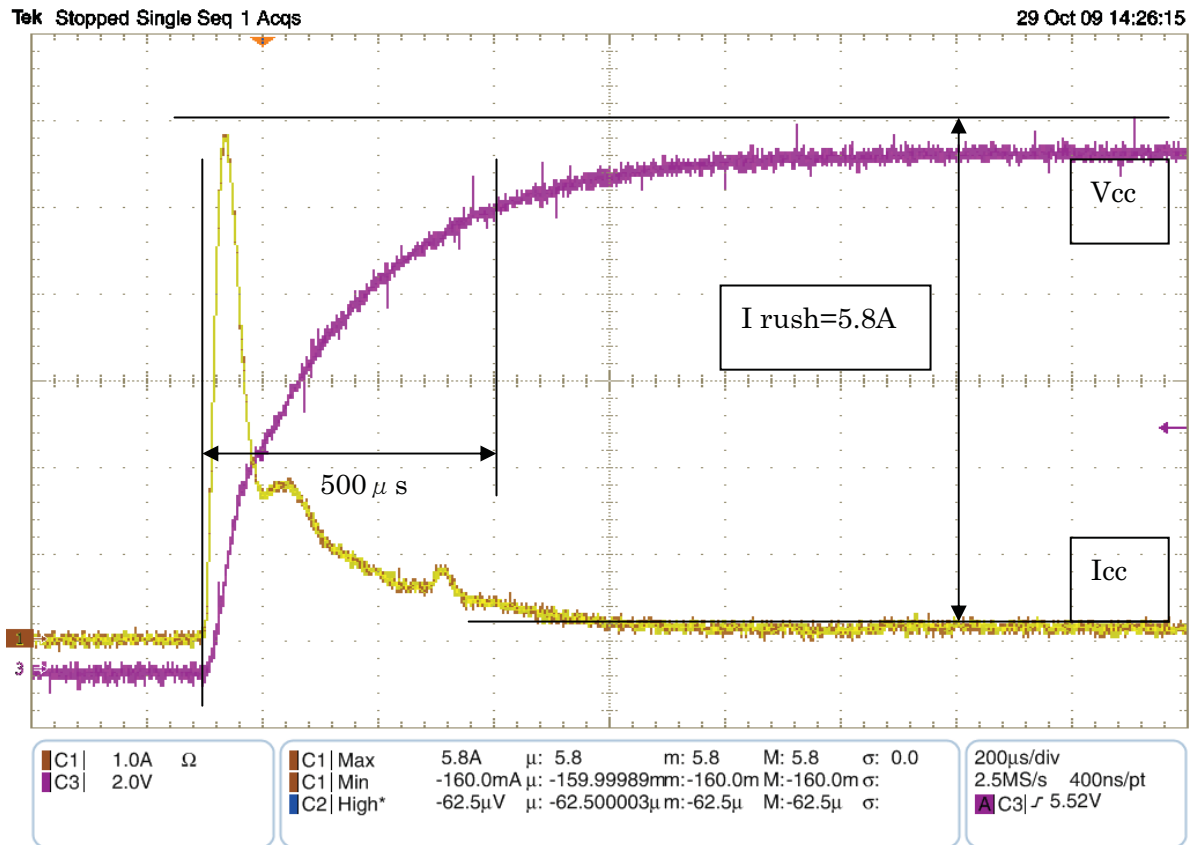

7. Timing characteristics of input signals

7.1. Timing characteristics

Timing diagrams of input signal are shown in Fig.2.

Parameter	Symbol	Min.	Typ.		Max.	Unit	Remark
			NTSC	PAL			
Clock	Frequency	55	74.25	74.25	80	MHz	
Data enable signal	Horizontal period	515	550	550	825	clock	
		7.10	7.41	7.41	11.1	μ s	
	Horizontal period (High)	480	480	480	480	clock	
	Vertical period	1120	1125	1350	1400	line	
		73.052	120	120	123.00	Hz	
Vertical period (High)	1080	1080	1080	1080	line		

[Note]-When vertical period is very long, flicker and etc. may occur.

-Please turn off the module after it shows the black screen.

-Please make sure that length of vertical period should become of an integral multiple of horizontal length of period.

Otherwise, the screen may not display properly.

-As for your final setting of driving timing, we will conduct operation check test at our side, please inform your final setting.

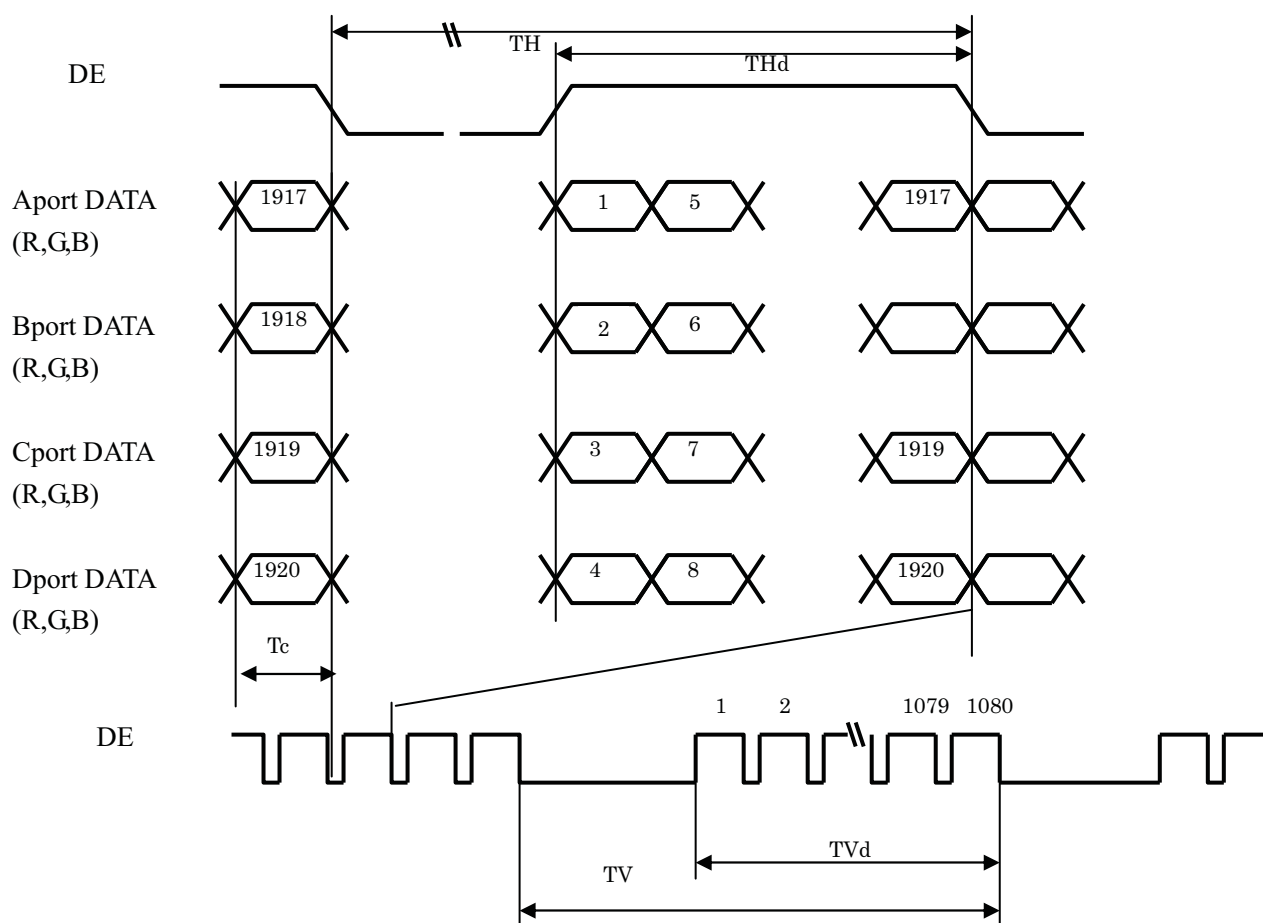
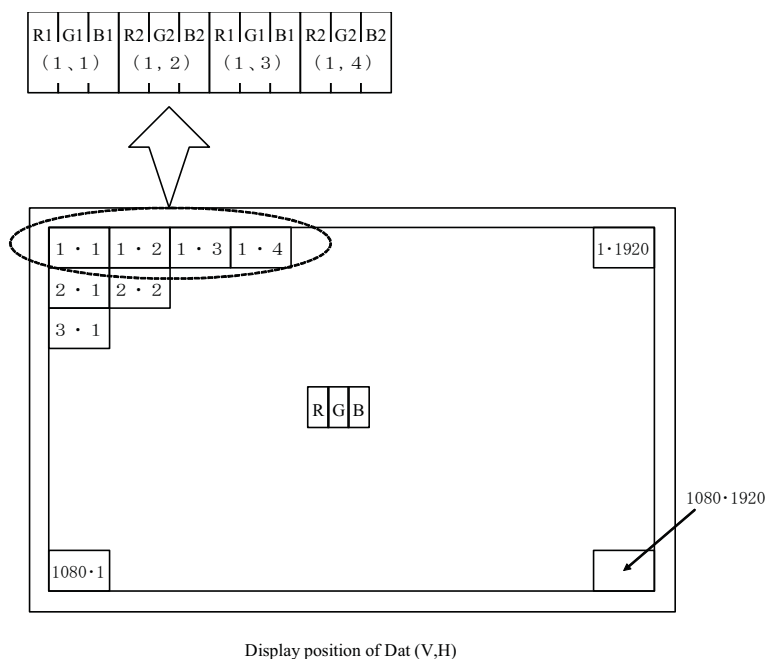
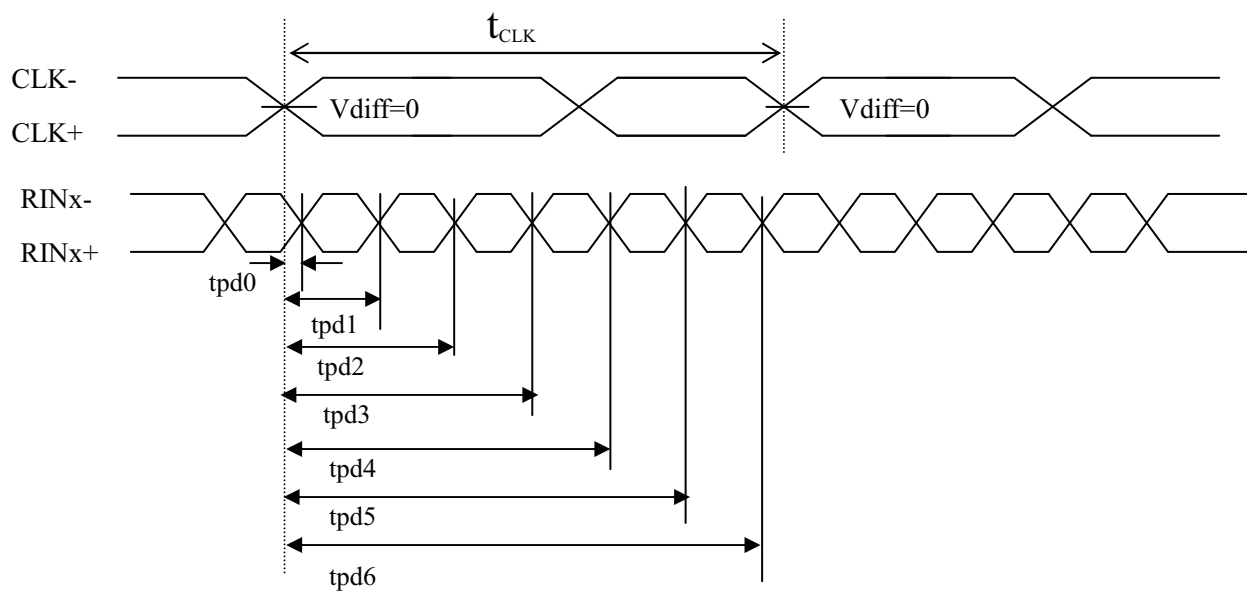

Fig.2 Timing characteristics of input signals

7.2. Input data signal and display position on the screen



7.3. LVDS signal characteristics (1)



The item		Symbol	min.	typ.	max.	unit
Data position	Delay time, CLK rising edge to serial bit position 0	tpd0	-0.25	0	0.25	ns
	Delay time, CLK rising edge to serial bit position 1	tpd1	$1 * t_{CLK} / 7 - 0.25$	$1 * t_{CLK} / 7$	$1 * t_{CLK} / 7 + 0.25$	
	Delay time, CLK rising edge to serial bit position 2	tpd2	$2 * t_{CLK} / 7 - 0.25$	$2 * t_{CLK} / 7$	$2 * t_{CLK} / 7 + 0.25$	
	Delay time, CLK rising edge to serial bit position 3	tpd3	$3 * t_{CLK} / 7 - 0.25$	$3 * t_{CLK} / 7$	$3 * t_{CLK} / 7 + 0.25$	
	Delay time, CLK rising edge to serial bit position 4	tpd4	$4 * t_{CLK} / 7 - 0.25$	$4 * t_{CLK} / 7$	$4 * t_{CLK} / 7 + 0.25$	
	Delay time, CLK rising edge to serial bit position 5	tpd5	$5 * t_{CLK} / 7 - 0.25$	$5 * t_{CLK} / 7$	$5 * t_{CLK} / 7 + 0.25$	
	Delay time, CLK rising edge to serial bit position 6	tpd6	$6 * t_{CLK} / 7 - 0.25$	$6 * t_{CLK} / 7$	$6 * t_{CLK} / 7 + 0.25$	

7.3. LVDS signal characteristics (2)

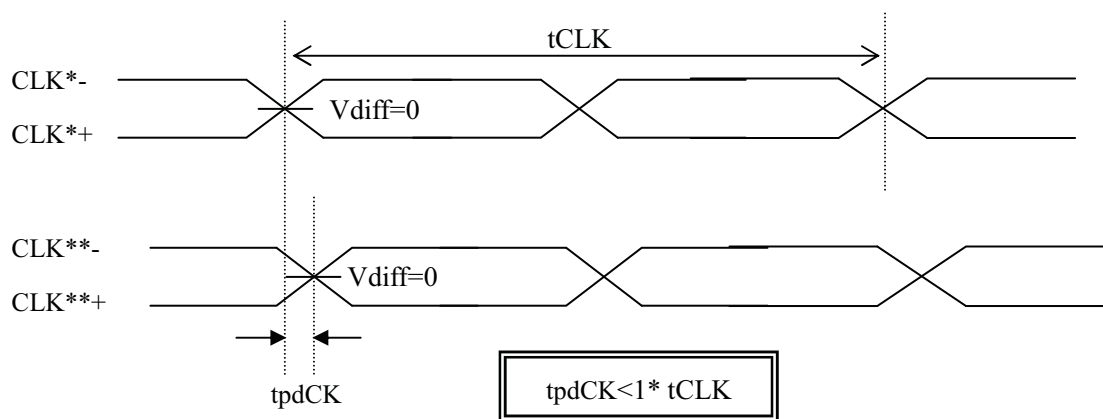

8. Input Signal, Basic Display Colors and Gray Scale of Each Color

Colors & Gray scale	Data signal																																				
	Gray Scale	R0	R1	R2	R3	R4	R5	R6	R7	R8	R9	G0	G1	G2	G3	G4	G5	G6	G7	G8	G9	B0	B1	B2	B3	B4	B5	B6	B7	B8	B9						
Basic Color	Black	-	0	0	0	0	0	0	0	0	0	0	0	0	0	0	0	0	0	0	0	0	0	0	0	0	0	0	0	0	0	0	0	0			
	Blue	-	0	0	0	0	0	0	0	0	0	0	0	0	0	0	0	0	0	0	0	0	1	1	1	1	1	1	1	1	1	1	1	1			
	Green	-	0	0	0	0	0	0	0	0	0	0	1	1	1	1	1	1	1	1	1	1	0	0	0	0	0	0	0	0	0	0	0	0			
	Cyan	-	0	0	0	0	0	0	0	0	0	0	1	1	1	1	1	1	1	1	1	1	1	1	1	1	1	1	1	1	1	1	1	1			
	Red	-	1	1	1	1	1	1	1	1	1	1	0	0	0	0	0	0	0	0	0	0	0	0	0	0	0	0	0	0	0	0	0	0	0		
	Magenta	-	1	1	1	1	1	1	1	1	1	1	0	0	0	0	0	0	0	0	0	0	1	1	1	1	1	1	1	1	1	1	1	1	1		
	Yellow	-	1	1	1	1	1	1	1	1	1	1	1	1	1	1	1	1	1	1	1	1	0	0	0	0	0	0	0	0	0	0	0	0	0	0	
	White	-	1	1	1	1	1	1	1	1	1	1	1	1	1	1	1	1	1	1	1	1	1	1	1	1	1	1	1	1	1	1	1	1	1	1	
Gray Scale of Red	Black	GS0	0	0	0	0	0	0	0	0	0	0	0	0	0	0	0	0	0	0	0	0	0	0	0	0	0	0	0	0	0	0	0	0	0		
	↑	GS1	1	0	0	0	0	0	0	0	0	0	0	0	0	0	0	0	0	0	0	0	0	0	0	0	0	0	0	0	0	0	0	0	0	0	
	Darker	GS2	0	1	0	0	0	0	0	0	0	0	0	0	0	0	0	0	0	0	0	0	0	0	0	0	0	0	0	0	0	0	0	0	0	0	
	↑	↓																																			
	↓	↓																																			
	Brighter	GS1021	1	0	1	1	1	1	1	1	1	1	0	0	0	0	0	0	0	0	0	0	0	0	0	0	0	0	0	0	0	0	0	0	0	0	
	↓	GS1022	0	1	1	1	1	1	1	1	1	1	0	0	0	0	0	0	0	0	0	0	0	0	0	0	0	0	0	0	0	0	0	0	0	0	0
	Red	GS1023	1	1	1	1	1	1	1	1	1	1	0	0	0	0	0	0	0	0	0	0	0	0	0	0	0	0	0	0	0	0	0	0	0	0	0
Gray Scale of Green	Black	GS0	0	0	0	0	0	0	0	0	0	0	0	0	0	0	0	0	0	0	0	0	0	0	0	0	0	0	0	0	0	0	0	0	0	0	
	↑	GS1	0	0	0	0	0	0	0	0	0	1	0	0	0	0	0	0	0	0	0	0	0	0	0	0	0	0	0	0	0	0	0	0	0	0	0
	Darker	GS2	0	0	0	0	0	0	0	0	0	0	1	0	0	0	0	0	0	0	0	0	0	0	0	0	0	0	0	0	0	0	0	0	0	0	0
	↑	↓																																			
	↓	↓																																			
	Brighter	GS1021	0	0	0	0	0	0	0	0	0	1	0	1	1	1	1	1	1	1	1	1	0	0	0	0	0	0	0	0	0	0	0	0	0	0	0
	↓	GS1022	0	0	0	0	0	0	0	0	0	0	1	1	1	1	1	1	1	1	1	1	0	0	0	0	0	0	0	0	0	0	0	0	0	0	0
	Green	GS1023	0	0	0	0	0	0	0	0	0	1	1	1	1	1	1	1	1	1	1	1	0	0	0	0	0	0	0	0	0	0	0	0	0	0	0
Gray Scale of Blue	Black	GS0	0	0	0	0	0	0	0	0	0	0	0	0	0	0	0	0	0	0	0	0	0	0	0	0	0	0	0	0	0	0	0	0	0	0	
	↑	GS1	0	0	0	0	0	0	0	0	0	0	0	0	0	0	0	0	0	0	0	1	0	0	0	0	0	0	0	0	0	0	0	0	0	0	0
	Darker	GS2	0	0	0	0	0	0	0	0	0	0	0	0	0	0	0	0	0	0	0	0	1	0	0	0	0	0	0	0	0	0	0	0	0	0	0
	↑	↓																																			
	↓	↓																																			
	Brighter	GS1021	0	0	0	0	0	0	0	0	0	0	0	0	0	0	0	0	0	0	0	1	0	1	1	1	1	1	1	1	1	1	1	1	1	1	1
	↓	GS1022	0	0	0	0	0	0	0	0	0	0	0	0	0	0	0	0	0	0	0	0	1	1	1	1	1	1	1	1	1	1	1	1	1	1	1
	Blue	GS1023	0	0	0	0	0	0	0	0	0	0	0	0	0	0	0	0	0	0	0	1	1	1	1	1	1	1	1	1	1	1	1	1	1	1	1

0: Low level voltage, 1: High level voltage.

Each basic color can be displayed in 1024 gray scales from 10 bits data signals. According to the combination of total 30 bits data signals, about one billion-color display can be achieved on the screen.

9. Optical characteristics

Ta=25°C, Vcc=12.0V, Brightness=100%, Timing:120Hz(typ. value)

Parameter		Symbol	Condition	Min.	Typ.	Max.	Unit	Remark
Viewing angle range	Horizontal	θ_{21} θ_{22}	CR \geq 10	70	88	-	Deg.	[Note1,4]
	Vertical	θ_{11} θ_{12}		70	88	-	Deg.	
Contrast ratio		CRn		3600	4500	-		[Note2,4]
Response time		τ_{DRV}			5		ms	[Note3,4,5]
Chromaticity	White	x	$\theta=0$ deg.	0.248	0.278	0.308	-	[Note4]
		y		0.255	0.285	0.315	-	
	Red	x		0.611	0.641	0.671	-	
		y		0.314	0.344	0.374	-	
	Green	x		0.250	0.280	0.310	-	
		y		0.577	0.607	0.637	-	
	Blue	x		0.114	0.144	0.174	-	
		y		0.042	0.072	0.102	-	
Luminance	White	Y_L		345	430		cd/m ²	[Note4]
Luminance uniformity	White	δw				1.25		[Note 6]

Measurement condition: - BLU Current(IBL): 115mA_{rms},

Lamp frequency(fBL): 62KHz, PWM dimming range(Dim): 100%

- Maximum luminance of white.

- The measurement shall be executed 60 minutes after lighting at rating.

[Note]The optical characteristics are measured using the following equipment.

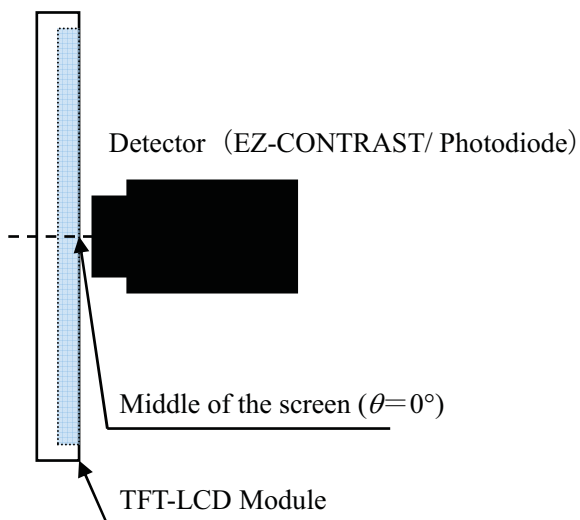

Fig.3-1 Measurement of viewing angle range and response time.

(Viewing angle range: EZ-CONTRAST
Response time: Photo Diode)

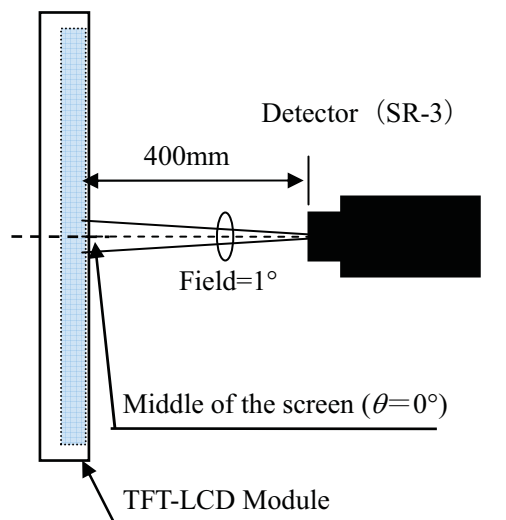
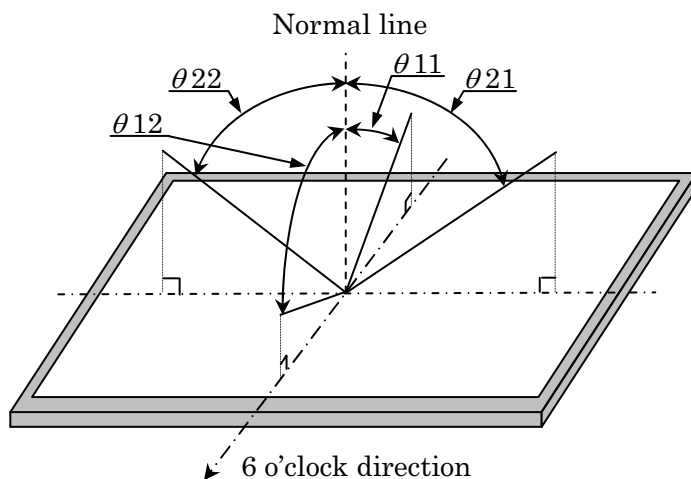

Fig.3-2 Measurement of Contrast, Luminance, Chromaticity.

(Contrast, Luminance and Chromaticity: SR-3)

[Note 1]Definitions of viewing angle range :



[Note 2]Definition of contrast ratio :

The contrast ratio is defined as the following.

$$\text{Contrast Ratio} = \frac{\text{Luminance (brightness) with all pixels white}}{\text{Luminance (brightness) with all pixels black}}$$

[Note 3]Definition of response time

The response time (τ_d and τ_r) is defined as the following figure and shall be measured by switching the input signal for “any level of gray (0%, 25%, 50%, 75% and 100%)” and “any level of gray (0%, 25%, 50%, 75% and 100%)”.

	0%	25%	50%	75%	100%
0%		tr:0%-25%	tr:0%-50%	tr:0%-75%	tr:0%-100%
25%	td: 25%-0%		tr: 25%-50%	tr25%-75%	tr: 25%-100%
50%	td: 50%-0%	td: 50%-25%		tr: 50%-75%	tr: 50%-100%
75%	td: 75%-0%	td: 75%-25%	td: 75%-50%		tr: 75%-100%
100%	td: 100%-0%	td: 100%-25%	td: 100%-50%	td:100%-75%	

t*:x-y...response time from level of gray(x) to level of gray(y)

$$\tau_r = \Sigma(\text{tr:x-y})/10, \tau_d = \Sigma(\text{td:x-y})/10$$

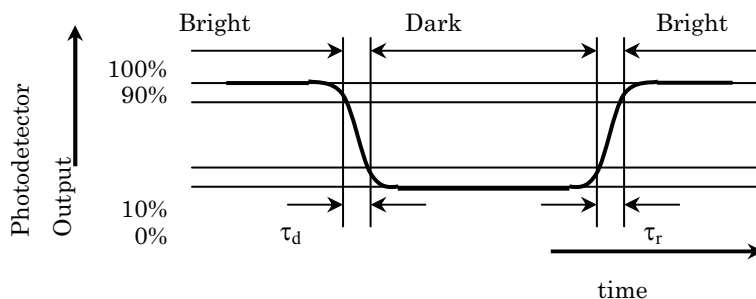

[Note 4]This shall be measured at center of the screen.

[Note 5] This value is valid when O/S driving is used at typical input time value.

[Note 6] Definition of white uniformity ;

White uniformity is defined as the following with five measurements. (A~E)

$$\delta_w = \frac{\text{Maximum luminance of five points (brightness)}}{\text{Minimum luminance of five points (brightness)}}$$

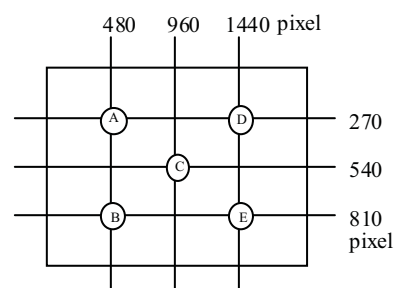

10. Handling Precautions of the module

- a) Be sure to turn off the power supply when inserting or disconnecting the cable.
- b) This product is using the parts (balancer board, CCFT etc), which generate the high voltage. Therefore, during operating, please don't touch these parts.
- c) Be sure to design the cabinet so that the module can be installed without any extra stress such as warp or twist.
- d) Since the front polarizer is easily damaged, pay attention not to scratch it.
- e) Since long contact with water may cause discoloration or spots, wipe off water drop immediately.
- f) When the panel surface is soiled, wipe it with absorbent cotton or other soft cloth.
- g) Since the panel is made of glass, it may break or crack if dropped or bumped on hard surface. Handle with care.
- h) Since CMOS LSI is used in this module, take care of static electricity and take the human earth into consideration when handling.
- i) The module has some printed circuit boards (PCBs) on the back side, take care to keep them form any stress or pressure when handling or installing the module; otherwise some of electronic parts on the PCBs may be damaged.
- j) Observe all other precautionary requirements in handling components.
- k) When some pressure is added onto the module from rear side constantly, it causes display non-uniformity issue, functional defect, etc. So, please avoid such design.
- l) When giving a touch to the panel at power on supply, it may cause some kinds of degradation. In that case, once turn off the power supply, and turn on after several seconds again, and that is disappear.
- m) When handling LCD modules and assembling them into cabinets, please be noted that long-term storage in the environment of oxidization or deoxidization gas and the use of such materials as reagent, solvent, adhesive, resin, etc. which generate these gasses, may cause corrosion and discoloration of the LCD modules.
- n) This LCD module is designed to prevent dust from entering into it. However, there would be a possibility to have a bad effect on display performance in case of having dust inside of LCD module. Therefore, please ensure to design your TV set to keep dust away around LCD module.
- o) Please set black image on display just before LCD module is switched off.

11. Packing form

- Piling number of cartons: (2 packages / 1 palette) × 2 maximum
- Packing quantity in one carton: 14 pcs.
- Carton size: 1140(W) × 890(D) × 1208(H)
- Total mass of one carton filled with full modules: 161.1 kg(Max)

12. Reliability test item

No.	Test item	Condition
1	High temperature storage test	Ta=60°C 240h
2	Low temperature storage test	Ta=-25°C 240h
3	High temperature and high humidity operation test	Ta=40°C ; 95%RH 240h (No condensation)
4	High temperature operation test	Ta=50°C 240h
5	Low temperature operation test	Ta=0°C 240h
6	Vibration test (non-operation)	Frequency: 10~57Hz/Vibration width (one side): 0.075mm : 58~500Hz/Acceleration: 9.8 m/s ² Sweep time: 11 minutes Test period: 3 hours (1h for each direction of X, Y, Z)
7	Shock test (non-operation)	Test spec: 50Grms / 11ms Direction: +/-X, +/-Y, +/-Z, once for each direction.
8	ESD	* At the following conditions, it is a thing without incorrect operation and destruction. (1)Non-operation: Contact electric discharge ±10kV Non-contact electric discharge ±20kV (2)Operation Contact electric discharge ±8kV Non-contact electric discharge ±15kV Conditions: 150pF, 330ohm

[Result evaluation criteria]

Under the display quality test condition with normal operation state, there shall be no change, which may affect practical display function.

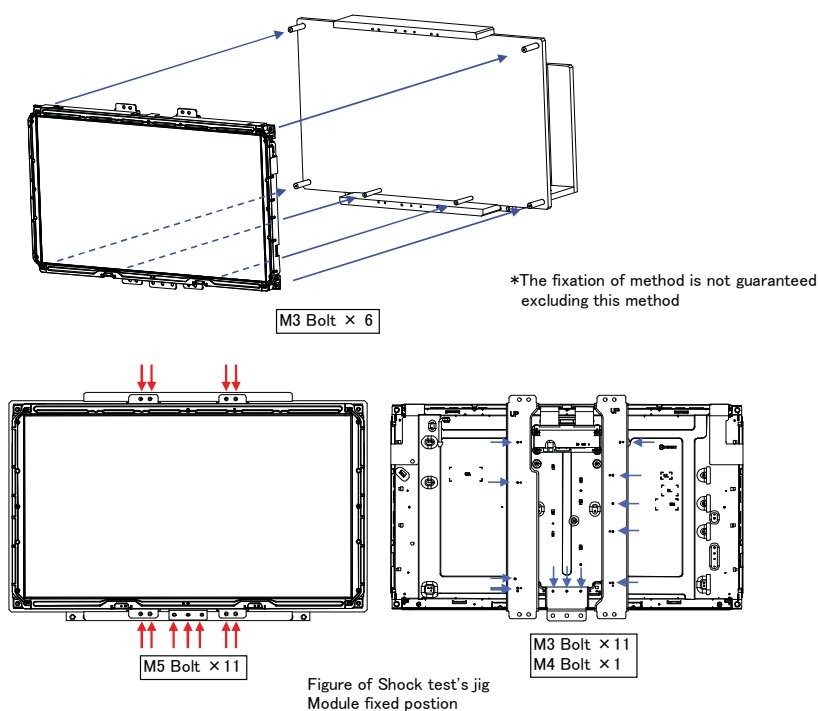

13. Others

1) Lot No. Label ;

The label that displays SHARP, product model (LK315D3LA57), a product number is stuck on the back of the module.

[LK315D3LA57] SMPL/JABIL PRODUCTION

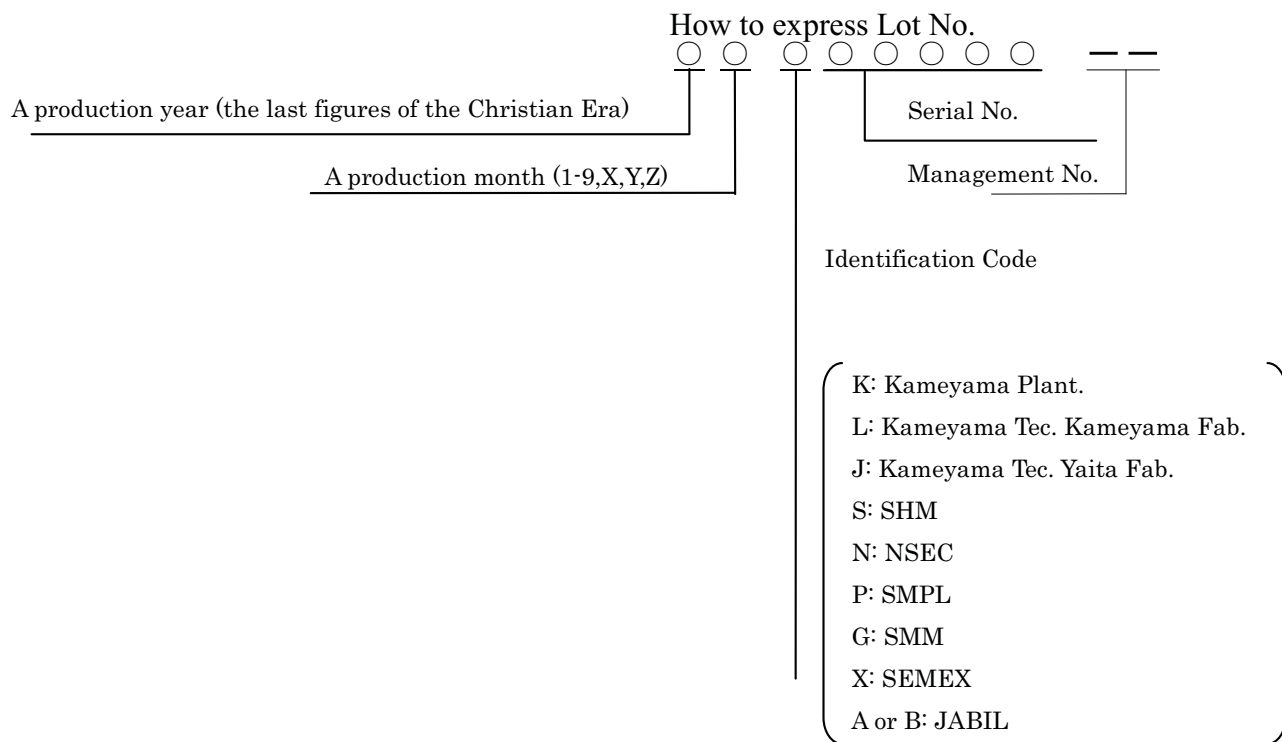
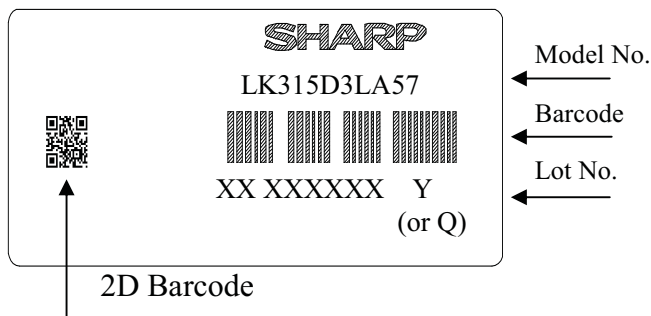

2) Packing Label

[LK315D3LA57Y (or Q)] SMPL PRODUCTION

社内品番 : (4 S) LK315D3LA57Y (or Q) ①	
Bar code	
Lot NO. · (1 T) 2009. *.*.* ②	
Bar code	
Quantity :	14 pcs ③
Bar code	
ユーザ品番	
Bar code	
シャープ物流用ラベルです。	

[LK315D3LA17Y(Q)] JABIL RODUCTION

社内品番 : (4 S) LK315D3LA57Y (or Q) ①	
Bar code	
Lot NO. · (1 T) 2009. *.*.* ②	
Bar code	
Quantity :	14 pcs ③
Bar code	
CUSTOMER MODEL	

- ① Management No
 ② Lot No. (Date)
 ③ Quantity

3) Adjusting volume have been set optimally before shipment, so do not change any adjusted value.

If adjusted value is changed, the specification may not be satisfied.

4) Disassembling the module can cause permanent damage and should be strictly avoided.

5) Please be careful since image retention may occur when a fixed pattern is displayed for a long time.

6) The chemical compound, which causes the destruction of ozone layer, is not being used.

7) Cold cathode fluorescent lamp in LCD PANEL contains a small amount of mercury. Please follow local ordinances or regulations for disposal. The below figure shows the label.

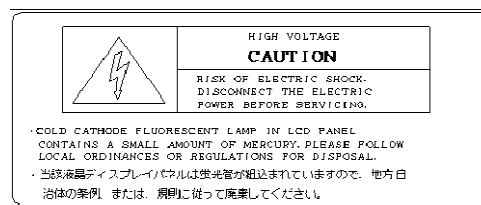

8) This LCD is appropriate to UL. Below figure shows the UL label.

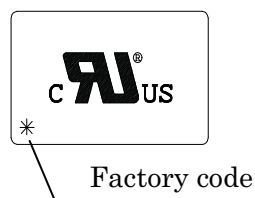

9) When any question or issue occurs, it shall be solved by mutual discussion.

10) Rust on the module is not taken up a problem.

11) Source-PWB(S-PWB) must be on upper side of LCD module when it is in the TV-set.

*:Please inform SHARP if S-PWB is at bottom side of LCD module when it is in the TV-set

12) This module is corresponded to RoHS.

14. Carton storage condition

Temperature	0°C to 40°C
Humidity	95%RH or less
Reference condition	: 20°C to 35°C, 85%RH or less (summer) : 5°C to 15°C, 85%RH or less (winter) • the total storage time (40°C,95%RH) : 240H or less
Sunlight	Be sure to shelter a product from the direct sunlight.
Atmosphere	Harmful gas, such as acid and alkali which bites electronic components and/or wires must not be detected.
Notes	Be sure to put cartons on palette or base, don't put it on floor, and store them with removing from wall Please take care of ventilation in storehouse and around cartons, and control changing temperature is within limits of natural environment
Storage life	1 year



品名	材質
Packing Case(Bottom)	Cardboard
Packing Case(Top)	Cardboard
Pack Ado(BottomA)	PS
Pack Ado(BottomB)	PS
Pack Ado(TopA)	PS
Pack Ado(TopB)	PS
Packing Case(Trunk frame)	Cardboard
Plywood Palette	Plywoods
Antistatic Bag	PE(t=20μ)

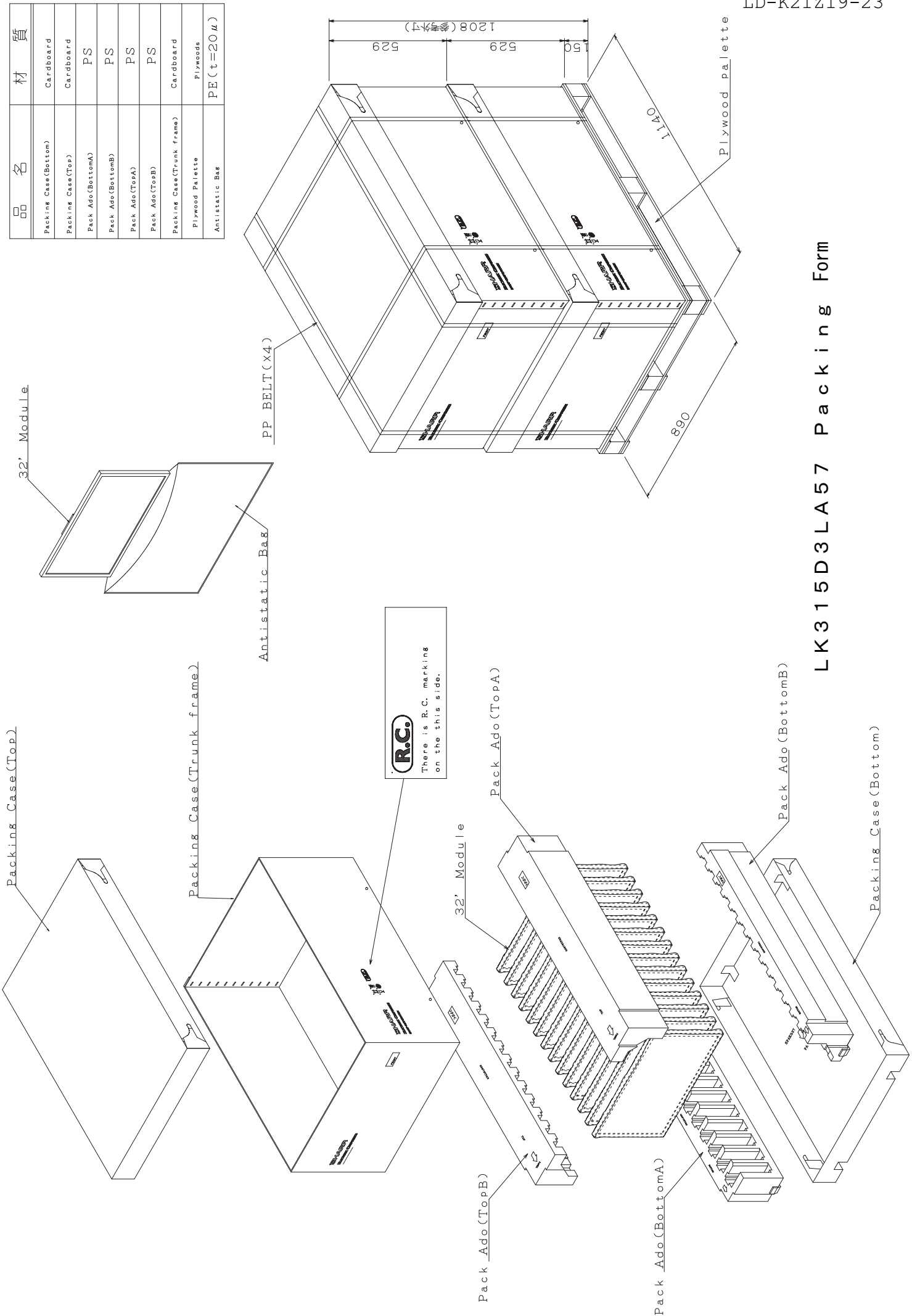

LK315D3LA57 Packing Form

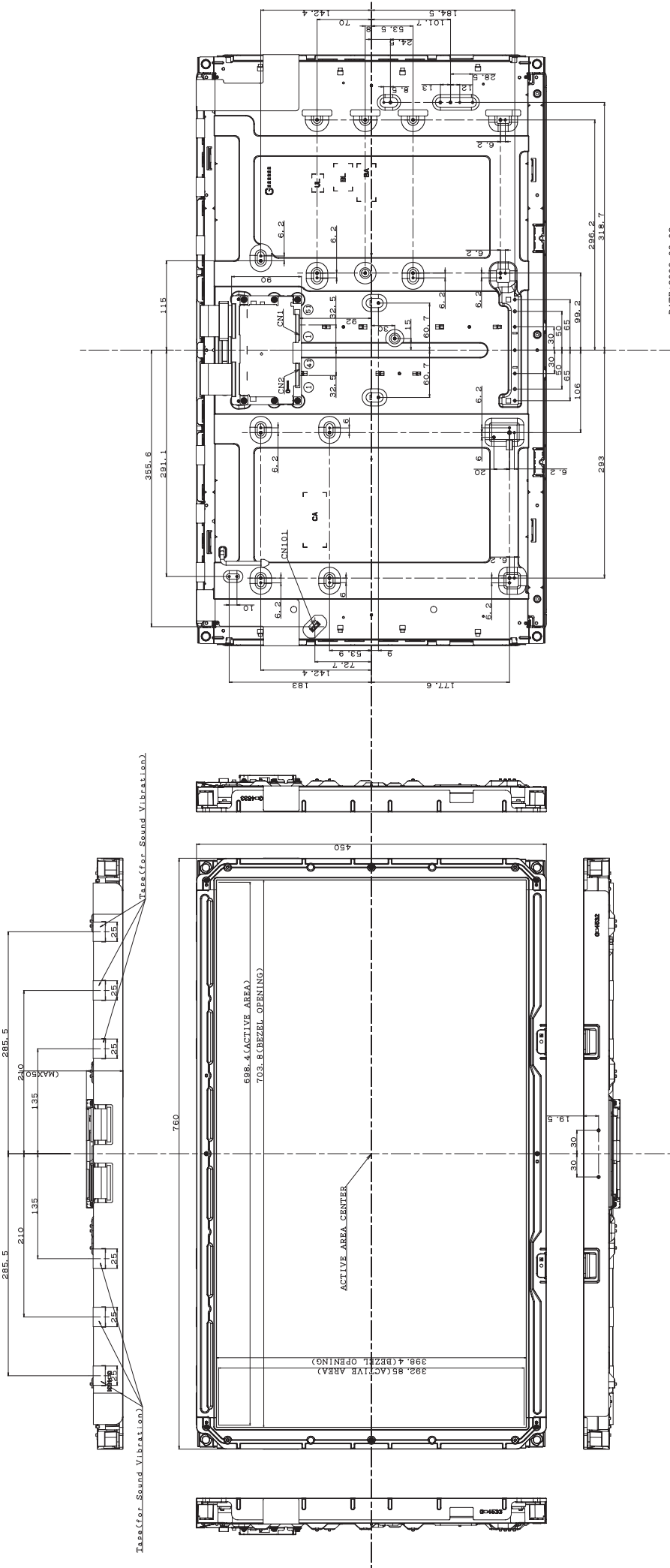

DATE:2009.05.08
 1. UNSPECIFIED TOLERANCE IS TO BE ± 1.0 mm.
 2. M4 TAPPING: TORQUE 0.88N·m(8Kgf·cm)
 3. M3 TAPPING: TORQUE 0.69N·m(6Kgf·cm)

Fig. 1 TFT-LCD MODULE OUTLINE DIMENSIONS
 LK315D3LA57