

# NAN YA PLASTICS CORPORATION

---

SPECIFICATION OF  
LCD MODULE  
PRODUCT NO.: LKCEAZ740Y1KS\_

SPEC. NO.: LM740-1A-1

CUSTOMER
APPROVED BY
DATE:

LCD DEPARTMENT  
ELECTRONIC MATERIALS DIVISION  
NAN YA PLASTICS CORPORATION  
201, TUNG HWA N. ROAD, TAIPEI  
TEL: 886-2-27122211 EXT. 5993~5995  
FAX: 886-2-27178253  
E-mail: lcdsales@npc.com.tw

EDITED ON : SEP.05, 2007

Q.C. DEPT.	DESIGN MANAGER	DESIGN CHECK	DESIGNER
			J.P Weng



# 1. MECHANICAL DATA

NO	ITEM	CONTENTS	UNIT
1	Product No.	LKCEAZ740Y1KS_	-
2	Module Size	143.7 (W) x 104.4 (H) x 13.85 (D)	mm
3	Dot Size	-- (W) x -- (H)	mm
4	Dot Pitch	0.12 (W) x 0.36 (H)	mm
5	Active Area	115.2 (W) x 86.4 (H)	Dot
6	Number of Dots	320 RGB (W) x 240 (H)	-
7	LCD Display Mode	TFT Module	-
8	Rear Polarizer	Transmissive	-
9	Viewing Direction	12	O'clock
10	Backlight	LED	-
11	Controller	Source:HX8218-C01(COG);Gate:HX8615-C(COG)	-
12	Touch Panel	Included	-
13	Weight	235 (Approx.)	g
14	Soldering	Lead Free	-

Note :

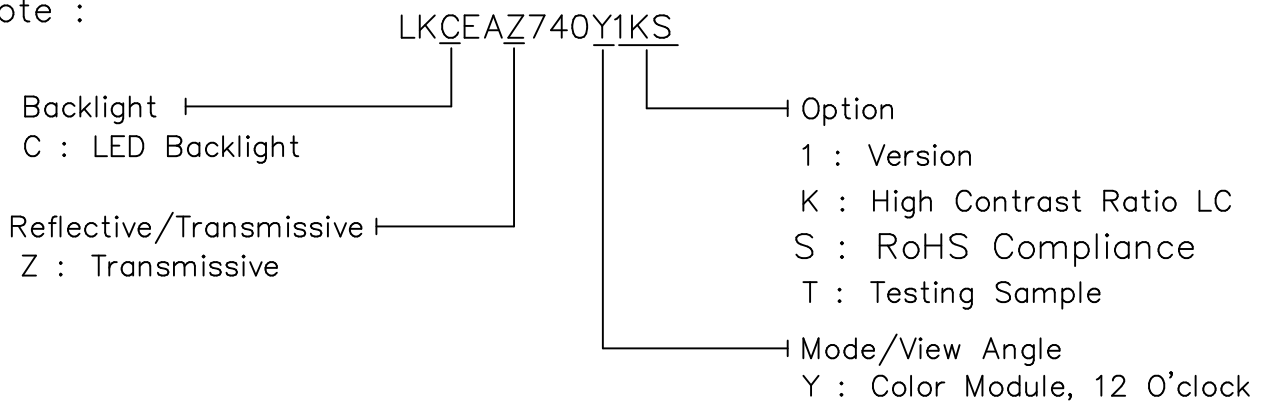

**RoHS Compliance.**

Nan Ya guarantees that this project doesn't include any materials (6 materials) or includes less than specified quantities which are regulated by RoHS Compliance.

## 2. ABSOLUTE MAXIMUM RATINGS

### (1) ELECTRICAL ABSOLUTE RATINGS

V<sub>ss</sub>=GND=0 Vdc

	SYMBOL	MIN.	MAX.	UNIT	COMMENT
Power Supply for Logic	VCC-GND	-0.3	7.0	V	
Input Voltage	V <sub>I</sub>	-0.3	VCC	V	
Static Electricity	-	-	-	-	Note 1

Note 1 LCM should be grounded during handling LCM.

### (2) ENVIRONMENTAL ABSOLUTE MAXIMUM RATINGS

ITEM	WIDE TEMP.			
	OPERATING		STORAGE	
	MIN.	MAX.	MIN.	MAX.
Ambient Temperature	-20	70	-40	80
Humidity (Without Condensation)	Note 2,4		Note 3,4	

Note 2  $T_a \leq 70^\circ\text{C}$  : 75%RH max

Note 3 Please refer to item of reliability test

Note 4 Background color will change slightly depending on ambient temperature.  
That phenomenon is reversible.

### 3. ELECTRICAL CHARACTERISTICS

#### 3-1. ELECTRICAL CHARACTERISTICS OF LCM

V<sub>SS</sub>=GND=0 V<sub>DC</sub>

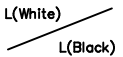
ITEM	SYMBOL	CONDITION	MIN.	TYP.	MAX.	UNIT		
Power Supply Voltage	VCC	-	3.0	3.3	3.6	V		
Input Voltage	V <sub>IH</sub>	H level	0.7VCC	-	VCC	V		
	V <sub>IO</sub>	L level	GND	-	0.3VCC			
LC Driving Voltage	V <sub>GH</sub> *1)	-	-	15	-	V *3)		
	V <sub>GL</sub> *2)		-	-10	-			
	V <sub>comH</sub>		2.5	-	5.5			
	V <sub>comL</sub>		-2.0	-	0			
Power Supply Current	I <sub>DD</sub> /T <sub>a</sub> =25°C	Normal Picture	-	100	160	mA		
Surface Luminance	L T <sub>a</sub> =25°C	Pattern:Dots All On I <sub>AK</sub> =140mA	280	320	-	cd/m <sup>2</sup>		
		Pattern:Dots All Off I <sub>AK</sub> =140mA	-	0.8	-			
Contrast Ratio(LCM)	LCM	Cr T <sub>a</sub> =25°C			250	400	-	-

Notes:

- \*1) V<sub>GH</sub> is TFT Gate on operating Voltage.
- \*2) V<sub>GL</sub> is TFT Gate off operating Voltage, V<sub>GL</sub> signal must be fluctuates with same phase as V<sub>com</sub> when Storage on Gate structure.
- \*3) V<sub>com</sub> must be adjusted to optimize display quality\_Crosstalk, Contrast Ratio and etc.

### 3-2.ELECTRICAL CHARACTERISTICS OF BACKLIGHT

Used LED Rating (Constant Current Driving)

Temp.=25°C

ITEM	SYMBOL	MIN.	TYP.	MAX.	UNIT	REMARK
Peak forward current	IP	-	-	210	mA	-
Maximum reverse voltage	VR	-	-	15	V	-
Applied forward current	IF	-	140	-	mA	-
Applied forward voltage	VF	-	10.2	10.8	V	-
LED power consumption	PF	-	-	2.25	W	-
LED life time	LL	-	40000	-	hrs	at IAK = 140mA (*1)

(\*1) LED life time is defined as follows : The final brightness is at 50% of original brightness.

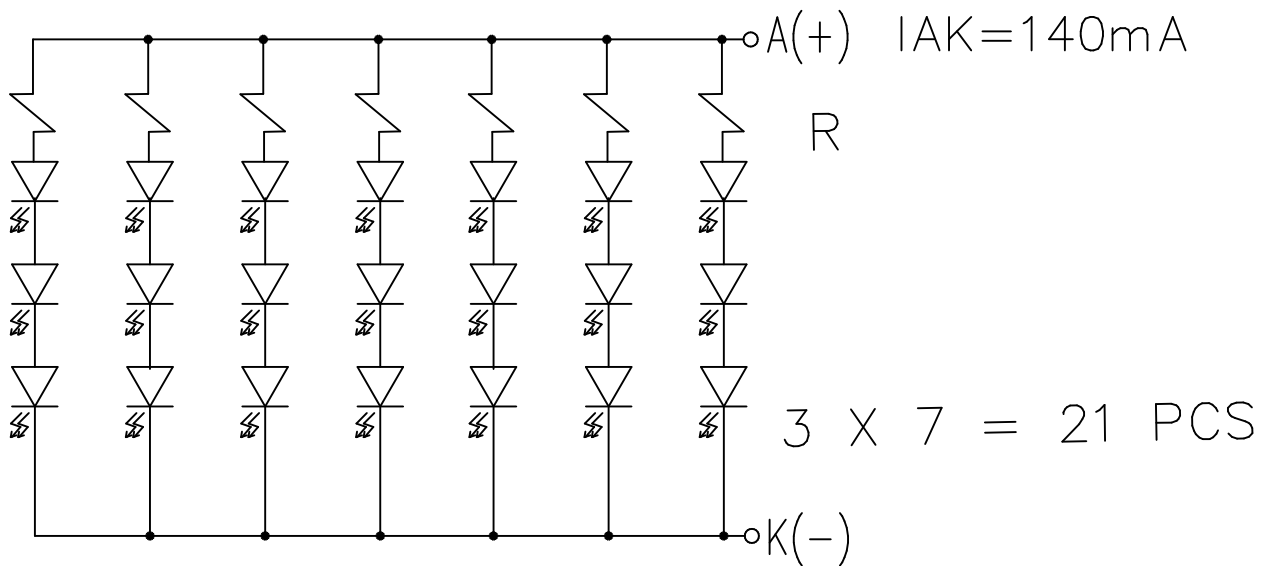

### 3-3.ELECTRICAL CHARACTERISTICS OF TOUCH PANEL

Used Touch screen Rating

Temp.=25°C

ITEM	SYMBOL	CONDITION	MIN.	TYP.	MAX.	UNIT
Operating Temperature	T <sub>OPR</sub>	20%~85% R.H. Max. Avoid Dew Condensation at Any Time	-20	-	70	°C
Storage Temperature	T <sub>STO</sub>		-30	-	80	
Resistance of Terminal Electrodes	R <sub>ETD</sub>	X Electrode	100	-	1100	Ω
		Y Electrode	100	-	1100	
Linearity	L	-	-	-	1.5	%
Insulation Resistance	R <sub>OFF</sub>	V <sub>DC</sub> =25V	20	-	-	MΩ
Transparency	T	According to JIS-K7015	80	-	-	%
Surface Hardness	S <sub>H</sub>	According to JIS-K5400	3	-	-	H

Test condition : Touch screen is placed horizontally in a vessel and no power is supplied to T/P.  
Normal state is temperature : 25±10°C, relative humidity : 60±25°C

## 4. OPTICAL CHARACTERISTICS

### 4.1 Optical Char. of LCD Panel

Parameter	SYMBOL	Values			Unit	NOTE		
		MIN.	TYP.	MAX.				
Response Time	Tr+Tf	-	50	-	ms	NOTE 2,3		
Contrast Ratio	C/R	-	250	-		*1)		
$\theta$ (Viewing Angle)	CR=10	-	F: 40 R: 60	-		NOTE 3,5		
$\phi$ (Viewing Angle)		-	L: 60 R: 60	-				
$\theta$ (Viewing Angle)	CR=5	-	F: 60 R: 70	-				
$\phi$ (Viewing Angle)		-	L: 70 R: 70	-				
Degree of Saturation	NTSC	-	58	-			%	

\*1) Contrast Ratio(CR) is define mathematically as :

$$\text{Contrast Ratio} = \frac{\text{Surface Luminance with all white pixels}}{\text{Surface Luminance with all black pixels}}$$



4.2 Color of CIE Coordinate

Ta = 25°C Tolerance : ±0.05

ITEM		SYMBOL	CONDITION	VALUE	NOTE
Color of CIE Coordinate	Red	X	$\phi=0^\circ, \theta=0^\circ$	0.55	Note*
		y		0.31	
	Green	X		0.30	
		y		0.58	
	Blue	X		0.15	
		y		0.10	
	White	X		0.31	
		y		0.34	

Note\* Measuring at position 3 on Fig.1 CIE chromaticity diagram

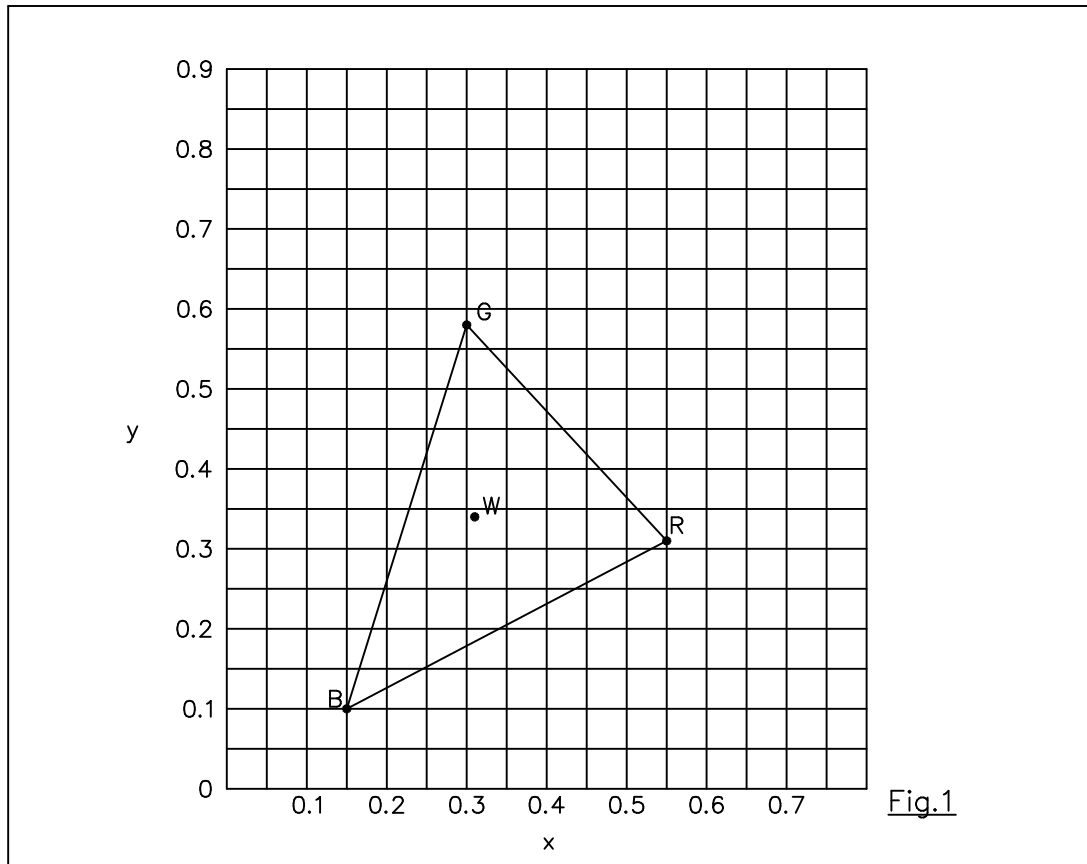

(NOTE 1)

Definition of Operation Voltage(Vop)

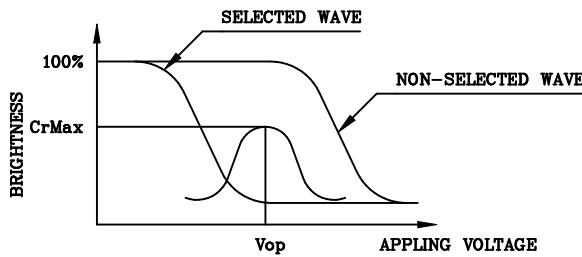

(positive type)

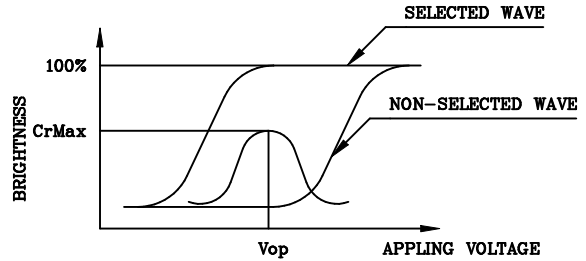

(negative type)

\*Conditions

Viewing Angle : 0  
Frame Frequency : 70Hz  
Applying Waveform : 1/N duty 1/a bias

(NOTE 2)

Definition of Response Time(Tr,Tf)

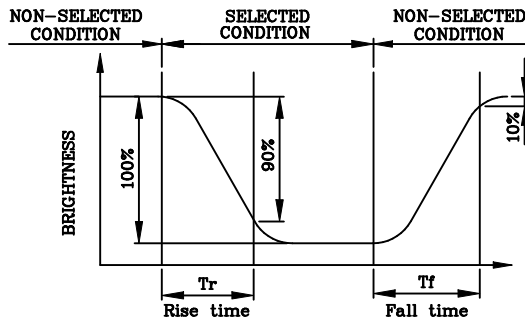

(positive type)

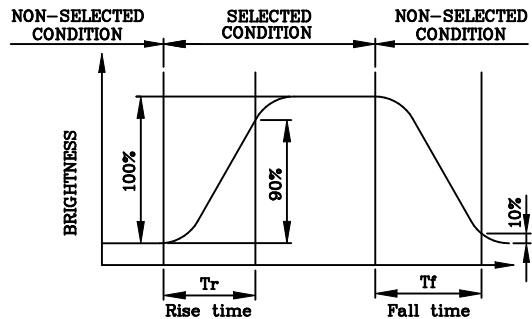

(negative type)

\*Conditions

Operating Voltage : Vop  
Viewing Angle (θ,φ) : (0,0)  
Frame Frequency : 70Hz  
Applying Waveform : 1/N duty 1/a bias

(NOTE 3)

Description of Measuring Equipment and Driving Waveforms

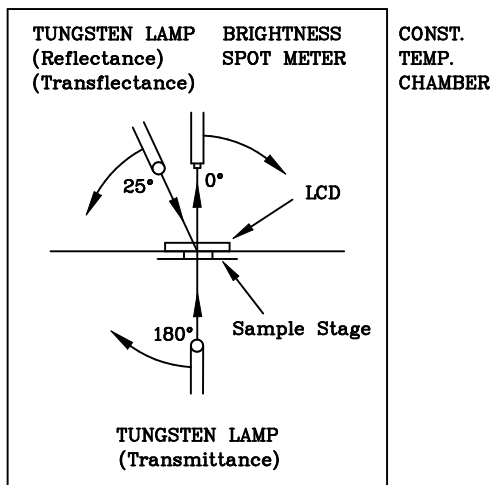

(NOTE 4)

Definition of Viewing Direction

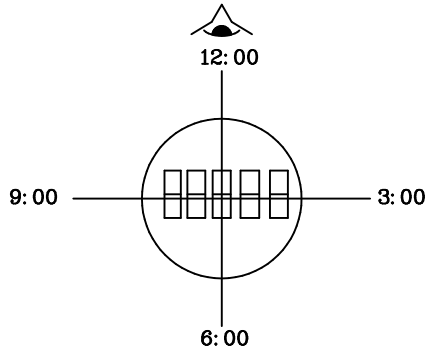

(NOTE 5)

Definition of Viewing Angle

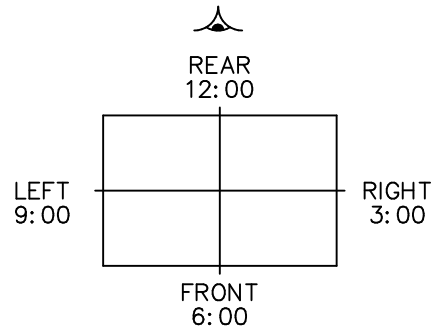
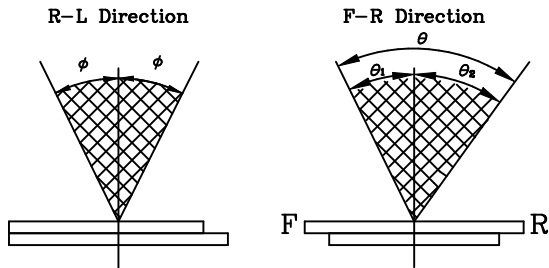

$$\theta = \theta_1 + \theta_2$$

\*Conditions

Operating Voltage :  $V_{op}$   
 Applying Waveform : 1/N duty 1/a bias  
 Contrast Ratio : larger than 10

(NOTE 6)

Definition of Contrast Ratio (Cr)

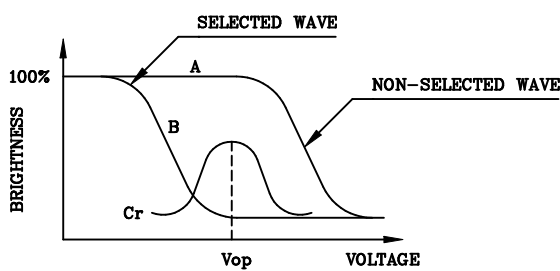

(positive type)

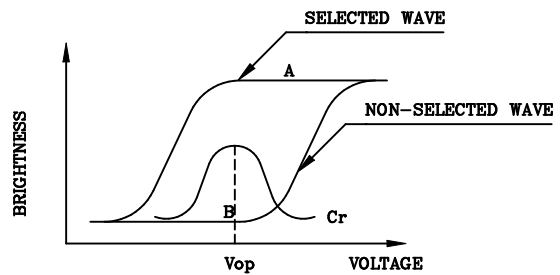

(negative type)

$$\text{Contrast Ratio : } Cr = A/B$$

\*Conditions

Viewing Angle : 0  
 Applying Waveform : 1/N duty 1/a bias

# 5. BLOCK DIAGRAM

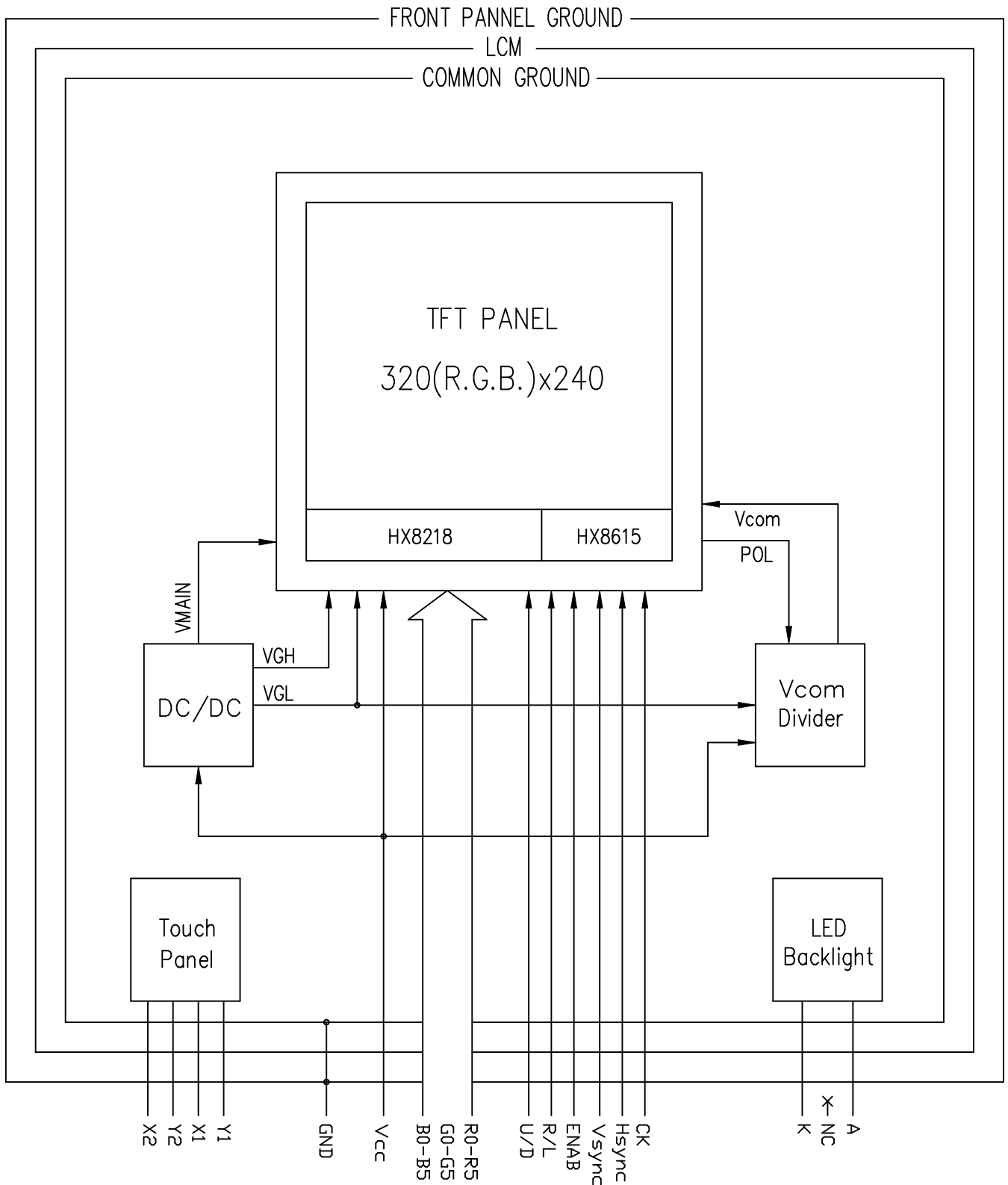

## 6. INTERNAL PIN CONNECTION

CN1 Connector : HIROSE FH12-33S-0.5SH

Mating FPC/FFC : Pitch 0.5mm/33 pin,T=0.3mm,W=17mm

PIN NO.	SYMBOL	FUNCTION
1	GND	Ground
2	CK	Clock Signal for Sampling Each Data Signal
3	Hsync	Horizontal Synchronous Signal
3	Vsync	Vertical Synchronous Signal
5	GND	Ground
6	R0	Red Data Signal (LSB)
7	R1	Red Data Signal
8	R2	Red Data Signal
9	R3	Red Data Signal
10	R4	Red Data Signal
11	R5	Red Data Signal (MSB)
12	GND	Ground
13	G0	Green Data Signal (LSB)
14	G1	Green Data Signal
15	G2	Green Data Signal
16	G3	Green Data Signal
17	G4	Green Data Signal
18	G5	Green Data Signal (MSB)
19	GND	Ground
20	B0	Blue Data Signal (LSB)
21	B1	Blue Data Signal
22	B2	Blue Data Signal
23	B3	Blue Data Signal
24	B4	Blue Data Signal
25	B5	Blue Data Signal (MSB)
26	GND	Ground
27	ENAB	Signal to Settle the Horizontal Display Position
28	Vcc	+3.3V Power Supply
29	Vcc	+3.3V Power Supply
30	R/L	Selection Signal for Horizontal Scanning Direction
31	U/D	Selection Signal for Vertical Scanning Direction
32	NC	Non-connection
33	GND	Ground

CN2 Connector : JST BHR-03VS-1  
Mating Connector : JST BHMR-03V

PIN NO.	SYMBOL	FUNCTION
1	K	Backlight LED Anode
2	NC	Non-connection
3	A	Backlight LED Cathode

CN3( FPC) : Pitch 1.0mm , thickness 0.3mm.  
Mating Connector :  
ELCO 04-6227-004-100-800+ or Compatible.

PIN NO.	SYMBOL	FUNCTION
1	Y1	Down Direction
2	X1	Left Direction
3	Y2	Up Direction
4	X2	Right Direction

# 7. POWER SUPPLY

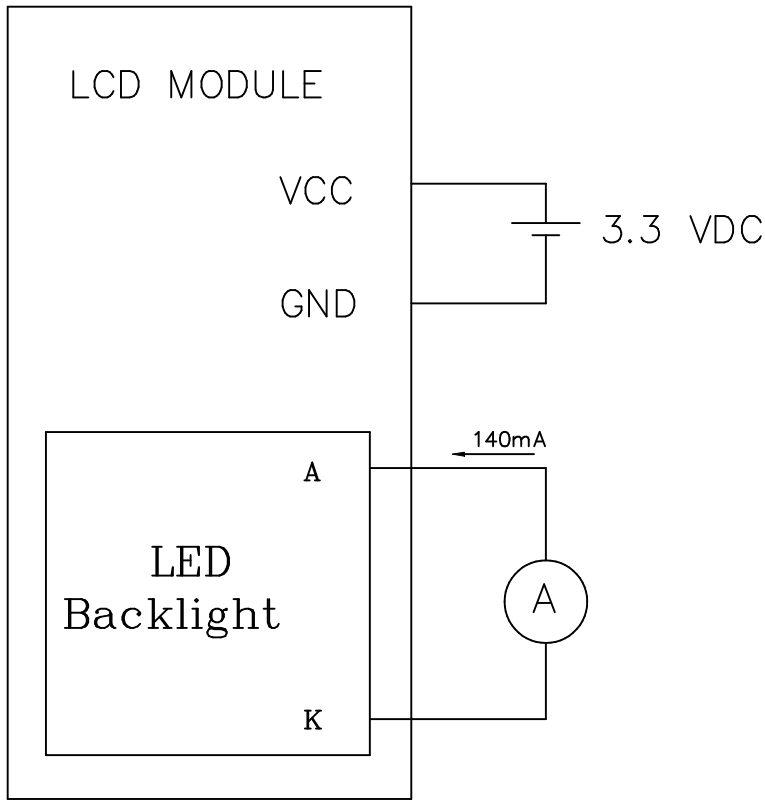

## 8. TIMING CHARACTERISTICS

### 8-1. INTERFACE TIMING

Refer Himax IC SPEC

Source: HX8218-C01(COG)

Gate: HX8615-C(COG)

### 8-2. DISPLAY SEQUENCE

	COLUMN 1			COLUMN 2		
ROW1	R1	G1	B1	R2	G2	B2
ROW2	R1	G1	B1	R2	G2	B2

COLUMN 319			COLUMN 320		
R319	G319	B319	R320	G320	B320
R319	G319	B319	R320	G320	B320

ROW239	R1	G1	B1	R2	G2	B2
ROW240	R1	G1	B1	R2	G2	B2

R319	G319	B319	R320	G320	B320
R319	G319	B319	R320	G320	B320

## 9. RELIABILITY TEST

NO	ITEM	CONDITION			STANDARD	NOTE
1	High Temp. Storage	80°C	120Hrs		Appearance without defect	
2	Low Temp. Storage	-40°C	120Hrs		Appearance without defect	
3	High Temp. & High Humi. Storage	60°C 90%RH	120Hrs		Appearance without defect	
4	High Temp. Operating Display	70°C	120Hrs		Appearance without defect	
5	Low Temp. Operating Display	-20°C	120Hrs		Appearance without defect	
6	Thermal Shock	-20°C,30min → 70°C,30min ↑ (1cycle)			Appearance without defect	10 cycles

1. Purpose

The NAN YA inspection provision provides outgoing inspection provision and its expected quality level based on our outgoing inspection of NAN YA LCD produces.

2. Applicable Scope

The NAN YA inspection provision is applicable to the arrangement in regard to outgoing inspection and quality assurance after outgoing.

3. Technical Terms

3-1 NAN YA Technical Terms

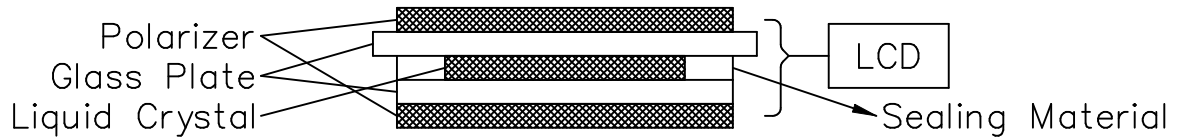

4. Outgoing Inspection

4-1 Inspection Method

MIL-STD-105E Level II Regular inspection

4-2 Inspection Standard

	Item		AQL(%)	Remarks
Major Defect	Dots	Opens, shorts Erroneous operation	0.4	Faults which substantially lower the practicality and the initial purpose difficult to achieve.
	Solder appearance	Shorts Loose		
	Cracks	Display surface cracks		
	Dimensions	External from dimensions (Should be within the tolerance)		
Minor Defect	Inside the glass	Black spots	0.65	Faults which appear to pose almost no obstacle to the practicality, effective use, and operation.
	Polarizing plate	Scratches, foreign, matter, air bubbles, and peeling.		
	Dots	Pinhole, deformation		
	Color tone	Color unevenness		
	Solder appearance	Cold solder Solder projections		



4-3 Inspection Provisions  
\*Viewing Area Definition

Fig. 1

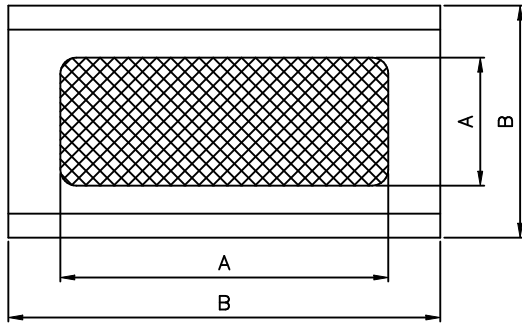

A : Zone Viewing Area  
B : Zone Glass Plate Outline

\*Inspection place to be 500 to 1000 lux illuminance uniformly without glaring.  
The distance between luminous source(daylight fluorescent lamp and cool white fluorescent lamp) and sample to be 30cm to 50cm.

\*Test and measurement are performed under the following conditions, unless otherwise specified.

Temperature	20± 15°C
Humidity	65± 20%R.H.
Pressure	860~1060hPa(mmbar)

In case of doubtful judgment, it is performed under the following conditions.

Temperature	20± 2°C
Humidity	65± 5%R.H.
Pressure	860~1060hPa(mmbar)

## 5. Specification for quality check

### 5-1-1 Electrical characteristics

NO.	Item	Criterion
1	Non operational	Fail
2	Miss operating	Fail
3	Contrast irregular	Fail
4	Response time	Within Specified value
5	Backlight turn on/off	Within Specified value
6	Touch Panel turn on/off	Within Specified value

### 5-1-2 Components soldering :

Should be no defective soldering such as shorting, loose terminal cold solder, peeling of printed circuit board pattern, improper mounting position, etc.

### 5-2 Inspection Standard for TFT panel

#### 5-2-1 The environmental condition of inspection

The environmental condition and visual inspection shall be conducted as below.

- (1) Ambient temperature :  $25 \pm 5^{\circ}\text{C}$
- (2) Humidity : 25~75% RH
- (3) External appearance inspection shall be conducted by using a single 20W fluorescent lamp or equivalent illumination.
- (4) Visual inspection on the operation condition for cosmetic shall be conducted at the distance 30cm or more between the LCD panels and eyes of inspector. The viewing angle shall be 90 degree to the front surface of display panel.
- (5) Ambient Illumination : 300~500 Lux for external appearance inspection.
- (6) Ambient Illumination : 100~200 Lux for light on inspection.

(1) Definition of dot defect induced from the panel inside

- a) The definition of dot : The size of a defective dot over 1/2 of whole dot is regarded as one defective dot.
- b) Bright dot : Dots appear bright and unchanged in size in which LCD panel is displaying under black pattern.
- c) Dark dot : Dots appear dark and unchanged in size in which LCD panel is displaying under pure red, green, blue pattern.
- d) 2 dot adjacent = 1 pair = 2 dots

Picture :



2 dot adjacent



2 dot adjacent  
(vertical)

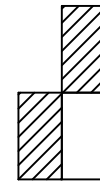

2 dot adjacent  
(slant)

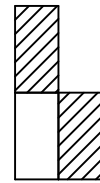

(2) Display Inspection

NO.	Item		Acceptable Count
1	Bright Dot	Random	$N \leq 2$
		2 dots adjacent	$N \leq 0$
	Dark Dot	Random	$N \leq 3$
		2 dots adjacent	$N \leq 1$
	Total bright and dark dot		$N \leq 4$
	Functional failure (V-line/ H-line/Cross line etc.)		Not allowable
Mura	It's OK if mura is slight visible through 6% ND filter. (Judged by limit sample if it is necessary)		
2	Newton ring (touch panel)	Orbicular of interference fringes is not allowed in the optimum contrast within the active area under viewing angle.	

(3) Appearance inspection

NO.	Item	Standards
1	Panel Crack	Not allow. It is shown in Fig.1.
2	Broken CF/Non-lead Side of TFT	The broken in the area of $W > 2\text{mm}$ is ignored, L is ignored. It is shown in Fig.2.
3	Broken Lead Side of TFT	FPC lead, electrical line or alignment mark can't be damaged. It is shown in Fig.3.
4	Broken Corner of TFT at Lead Side	FPC lead. electrical line or alignment mark can't be damaged. It is shown in Fig.4.
5	Burr of TFT/CF Edge	The distance of burr from the edge of TFT / CF, $W \leq 0.3\text{mm}$ . It is shown in Fig.5.
6	Foreign Black/White /Bright Spot	(1) $0.15 < D \leq 0.5 \text{ mm}$ , $N \leq 4$ (2) $D \leq 0.15\text{mm}$ , Ignore. It is shown in Fig.6.
7	Foreign Black/White /Bright Line	(1) $0.05 < W \leq 0.1 \text{ mm}$ , $0.3 < L \leq 2 \text{ mm}$ , $N \leq 4$ . (2) $W \leq 0.05\text{mm}$ and $L \leq 0.3\text{mm}$ Ignore. It is shown in Fig.7.
8	Color irregular	Not remarkable color irregular.

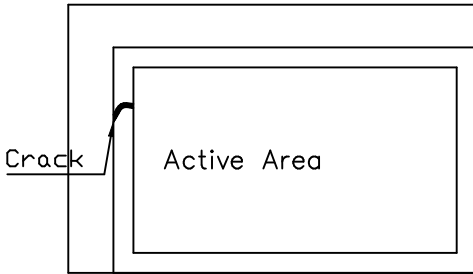

Fig.1.

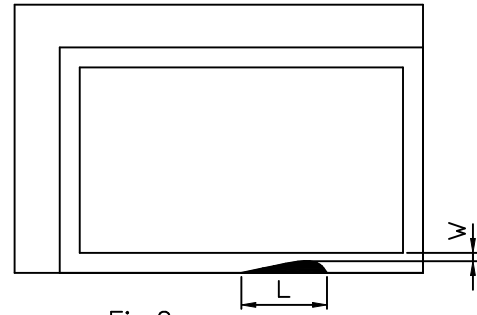

Fig.2.

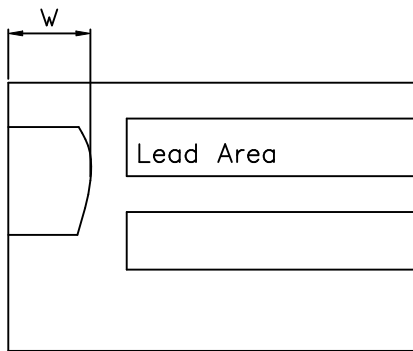

Fig.3.

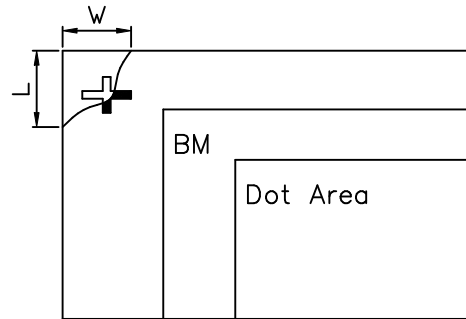

Fig.4.

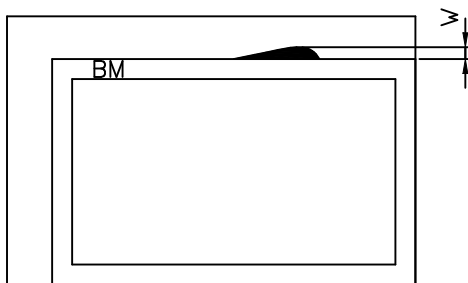
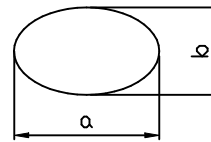

Fig.5.



$$D = (a+b)/2$$

Fig.6.

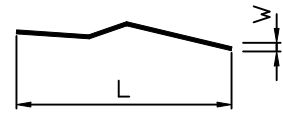

Fig.7.

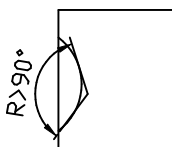

Fig.8.

Notes :

1. W : Width
2. L : Length
3. D : Average Diameter
4. N : Count
5. All the angle of the broken must be larger than 90°. It is shown in Fig.8.( $R > 90^\circ$ )

NOTICE:

• SAFETY

- 1.If the LCD panel breaks, be careful not to get the liquid crystal to touch your skin.
- 2.If the liquid crystal touches your skin or clothes, please wash it off immediately by using soap and water.

• HANDLING

- 1.Avoid static electricity which can damage the CMOS LSI.
- 2.Do not remove the panel or frame from the module.
- 3.The polarizing plate of the display is very fragile. So, please handle it very carefully.
- 4.Do not wipe the polarizing plate with a dry cloth, as it may easily scratch the surface of plate.
- 5.Do not use ketonics solvent & Aromatic solvent. Use a soft cloth soaked with a cleaning naphtha solvent.

• STORAGE

- 1.Store the panel or module in a dark place where the temperature is  $25^{\circ}\text{C}\pm 5^{\circ}\text{C}$  and the humidity is below 65% RH.
- 2.Do not place the module near organics solvents or corrosive gases.
- 3.Do not crush, shake, or jolt the module.

• TERMS OF WARRANT

- 1.Acceptance inspection period  
The period is within one month after the arrival of contracted commodity at the buyer's factory site.
- 2.Applicable warrant period  
The period is within twelve months since the date of shipping out under normal using and storage conditions.

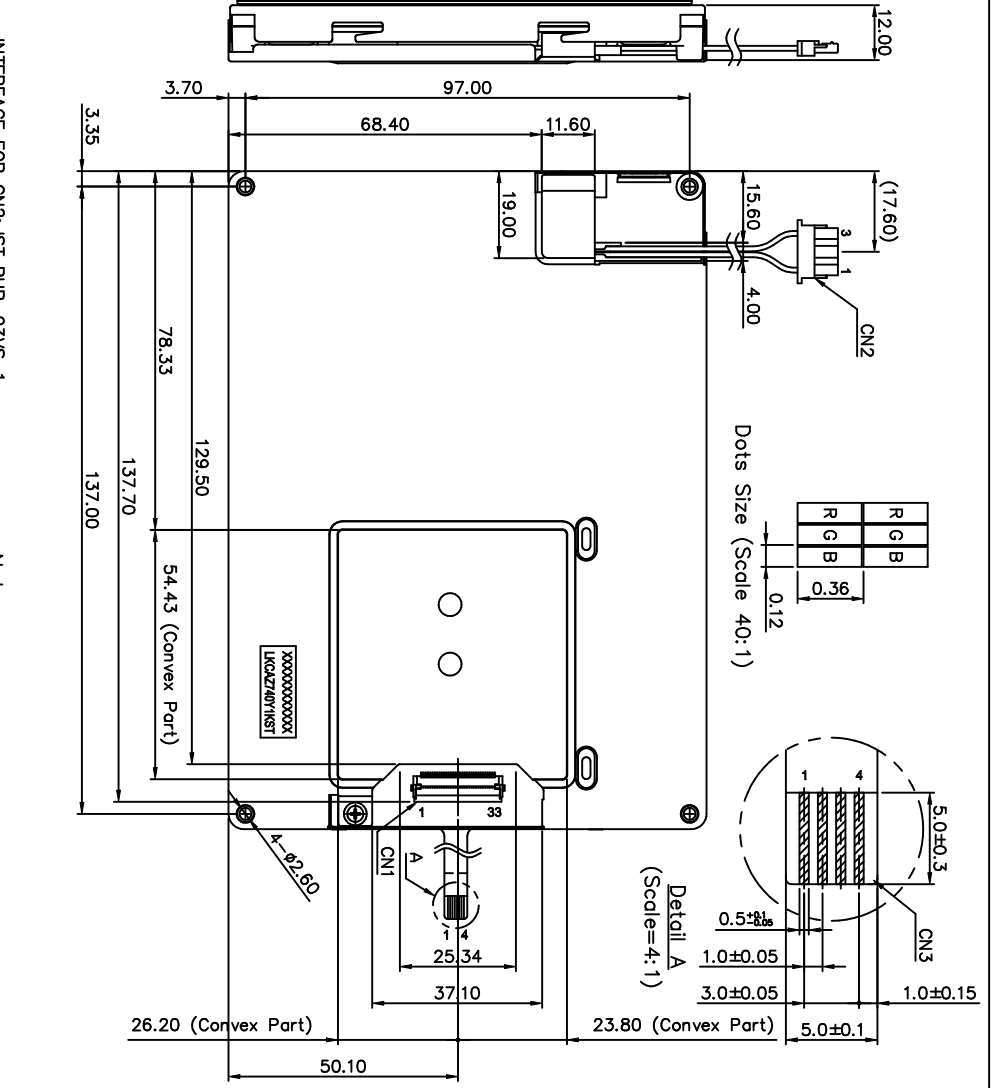
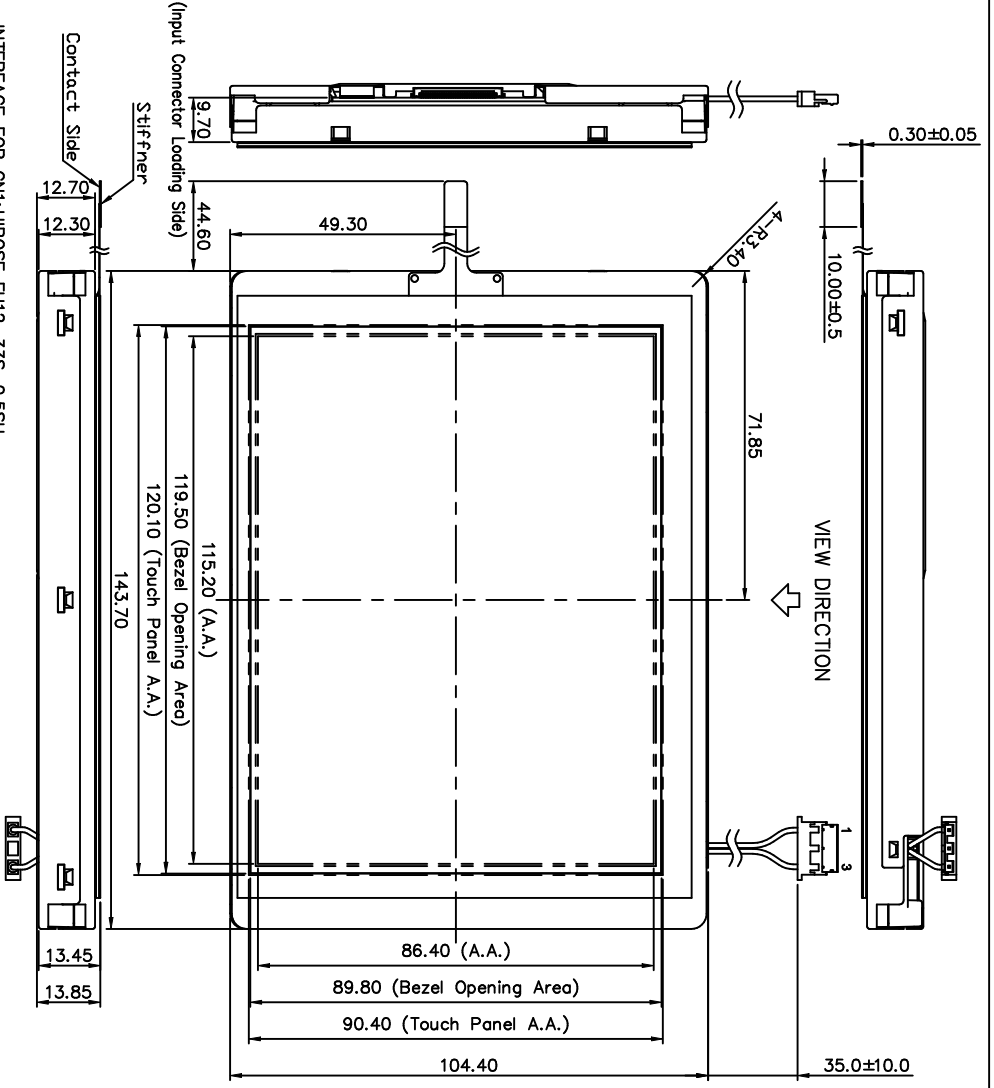

INTERFACE FOR CN1: HIROSE FH12-33S-0.5SH

PIN NO.	SYMBOL	FUNCTION
1	GND	Ground
2	CK	Clock Signal for Sampling Each Data Signal
3	Hsync	Horizontal Synchronous Signal
3	Vsync	Vertical Synchronous Signal
5	GND	Ground
6	R0	Red Data Signal (LSB)
7	R1	Red Data Signal
8	R2	Red Data Signal
9	R3	Red Data Signal
10	R4	Red Data Signal
11	R5	Red Data Signal (MSB)
12	GND	Ground
13	G0	Green Data Signal (LSB)
14	G1	Green Data Signal
15	G2	Green Data Signal
16	G3	Green Data Signal
17	G4	Green Data Signal

PIN NO.	SYMBOL	FUNCTION
18	G5	Green Data Signal (MSB)
19	GND	Ground
20	B0	Blue Data Signal (LSB)
21	B1	Blue Data Signal
22	B2	Blue Data Signal
23	B3	Blue Data Signal
24	B4	Blue Data Signal
25	B5	Blue Data Signal (MSB)
26	GND	Ground
27	ENAB	Signal to Settle the Horizontal Display Position
28	Vcc	+3.3V Power Supply
29	Vcc	+3.3V Power Supply
30	R/L	Selection Signal for Horizontal Scanning Direction
31	U/D	Selection Signal for Vertical Scanning Direction
32	NC	Non-connection
33	GND	Ground

INTERFACE FOR CN2: JST BHR-03VS-1

PIN NO.	SYMBOL	FUNCTION
1	K	Backlight LED Anode
2	NC	Non-connection
3	A	Backlight LED Cathode

INTERFACE FOR CN3:

PIN NO.	SYMBOL	FUNCTION
1	Y1	Down Direction
2	X1	Left Direction
3	Y2	Up Direction
4	X2	Right Direction

Notes:

- Resolution : (320x3) x 240 Dots
- Backlight : LED (White)
- Frame Material : SUS430 (t=0.3 mm)
- Touch Panel : Anti-Glare (t=1.0 mm)

GENERAL TOLERANCE LIST

DIMENSION	TOLERANCE
L ≤ 6	±0.25 (mm)
6 < L ≤ 18	±0.3 (mm)
18 < L ≤ 50	±0.4 (mm)
50 < L ≤ 125	±0.5 (mm)
125 < L	±0.6 (mm)
ANGLE	±1° (DEG)

南亞塑膠工業股份有限公司  
NAN YA PLASTICS CORPORATION  
製品圖  
LKCFE, AZ740Y1KS

REV. NO.	DESCRIPTION	DATE	DESIGN	CHECK	APPROVE

DWG NO. M7410AD1A

# THE NOTES OF LCM USING

LCM is easy to damage.

Please follow the notes as bellows, and be careful of handling!

## Correct handling

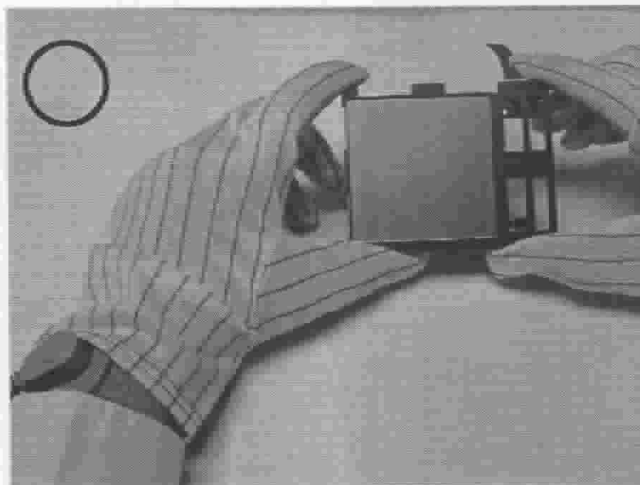
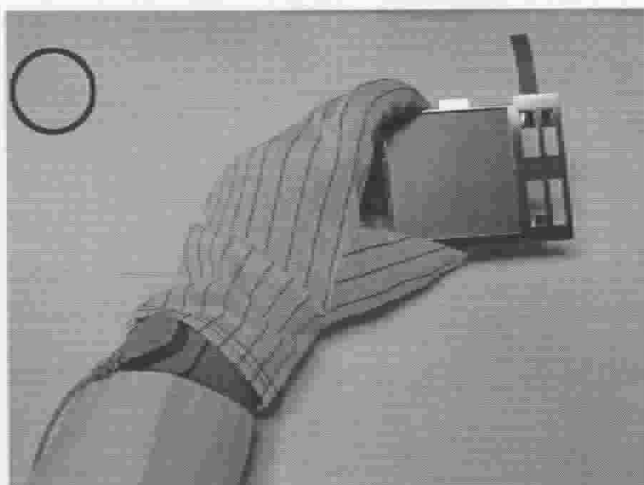

As above picture, please handle with glove by LCM edges and full EOS/ESD protection.

## Incorrect handling

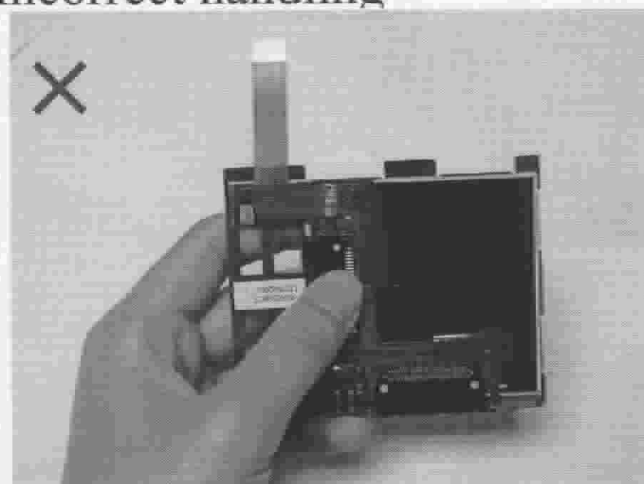

Please don't touch IC directly.

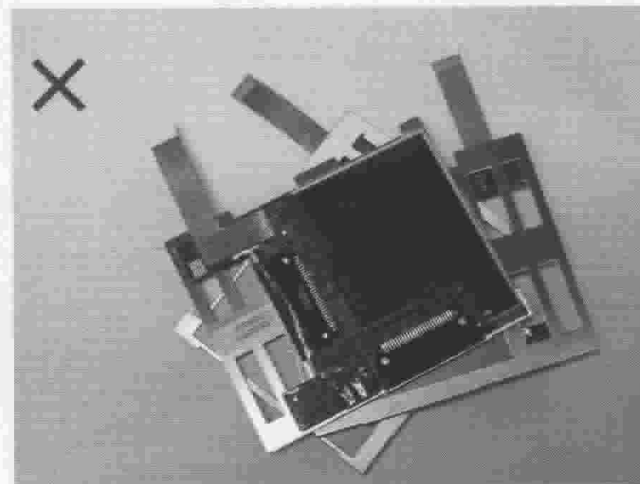

Please don't put one on another LCM.

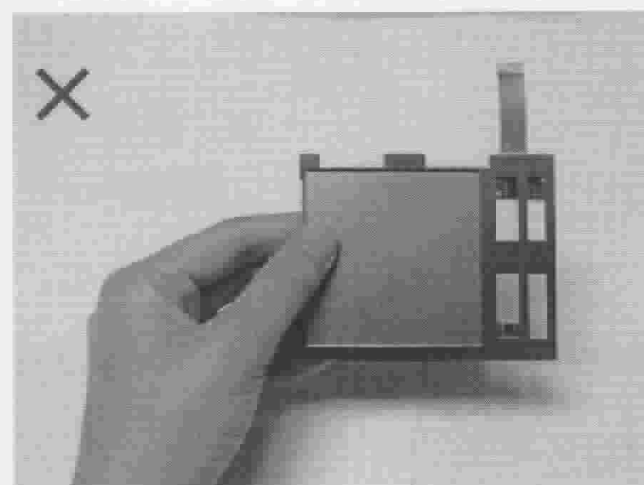

Please don't hold the surface of LCM.

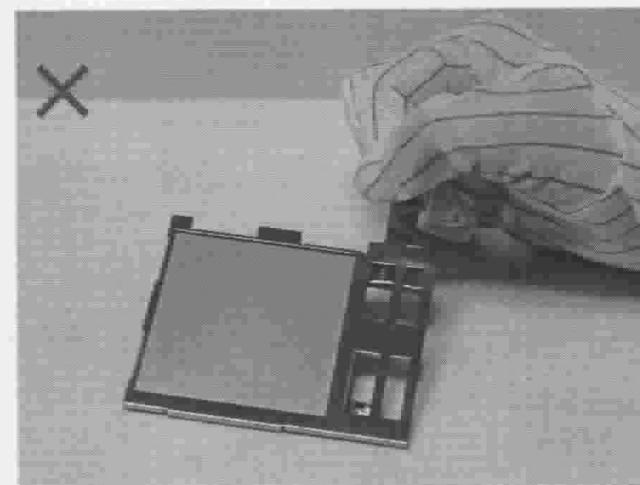

Please don't stretch interface of output.



# THE NOTES OF LCD USING

LCD is easy damage.

Please follow notes as bellows, and be careful of handling!

## Correct handling

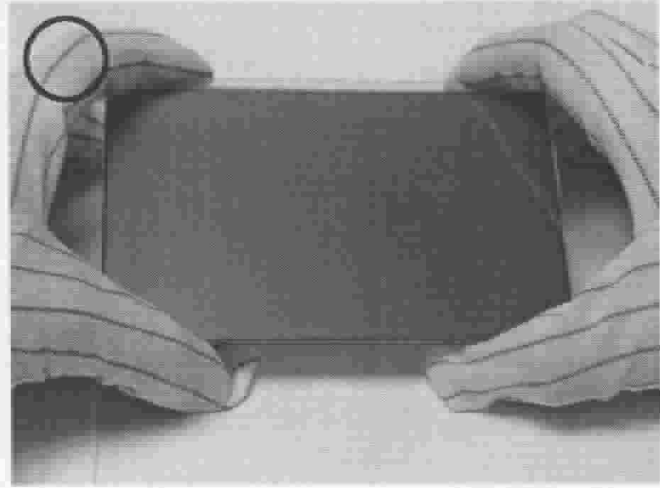
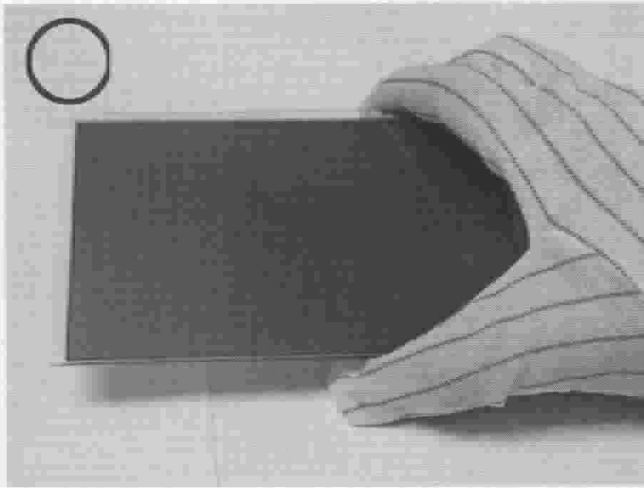

As above picture, please handle with glove by LCD edges and full EOS/ESD protection.

## Incorrect handling

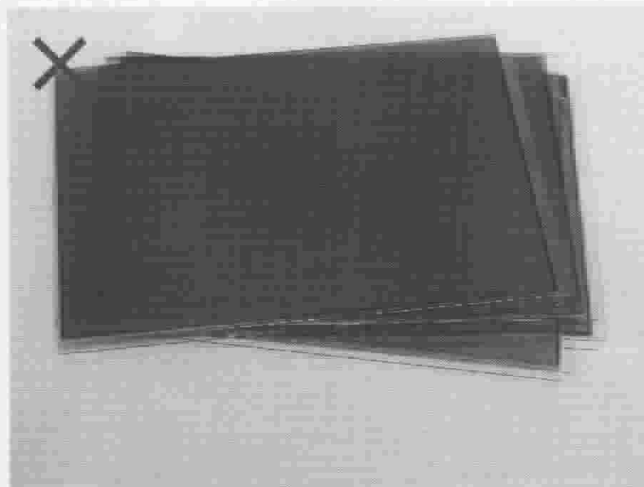

Please don't put one on another LCD.

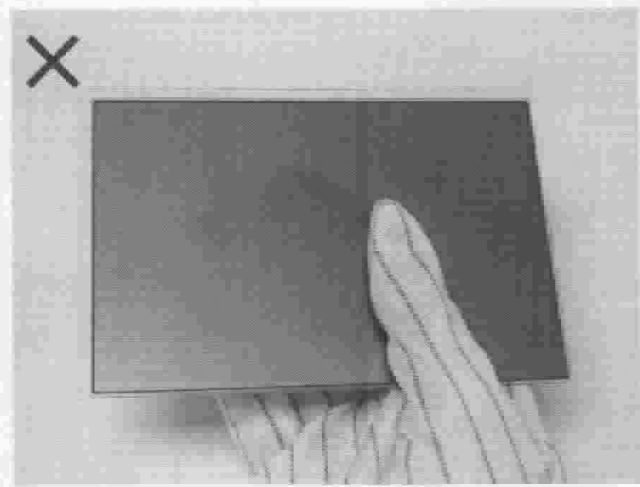

Please don't hold the surface of LCD.

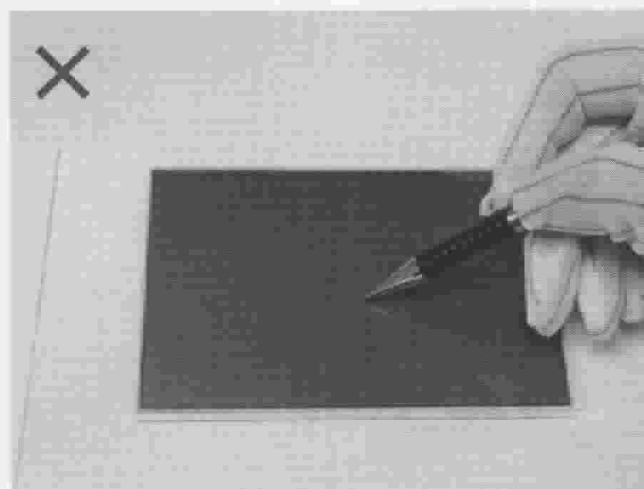

Please don't operate with sharp stick such as sharp pencil.

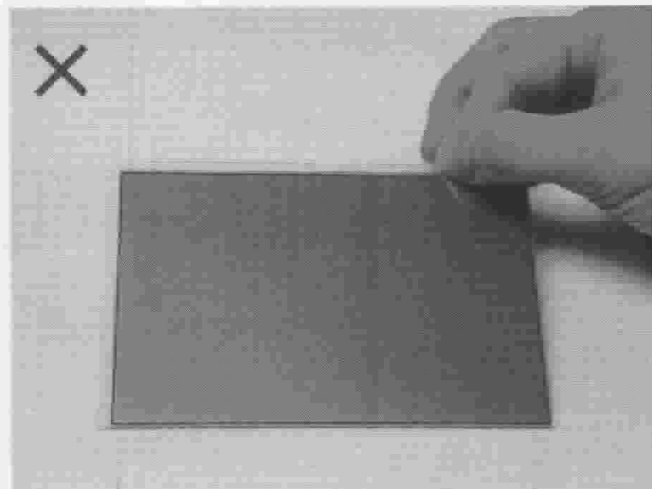

Please don't touch ITO glass without anti-static gloves.