

## ULTRA LOW CAPACITANCE TVS DIODE ARRAY

### Features

- Ultra low capacitance: 0.3pF typical (I/O to I/O)
- Ultra low leakage: nA level
- Low operating voltage: 5V
- Low clamping voltage
- Up to 4 lines protects
- Leadless flow-through package
- Complies with following standards:
  - IEC 61000-4-2 (ESD) immunity test
    - Air discharge:  $\pm 30\text{kV}$
    - Contact discharge:  $\pm 25\text{kV}$
  - IEC61000-4-5 (Lightning) 5A (8/20 $\mu\text{s}$ )
- RoHS Compliant

### Applications

- HDMI 1.3 & 1.4& 2.0, USB 2.0 & 3.0 and MDDI ports
- 10/100/1000 Ethernet
- Monitors and flat panel displays
- Set-top box and Digital TV
- Video graphics cards
- Digital Video Interface (DVI)
- Notebook Computers
- PCI Express and Serial SATA Ports

### Mechanical Characteristics

- Package: DFN2510-10 (2.5x1.0x0.5mm)
- Lead Finish: Matte Tin
- Case Material: "Green" Molding Compound.
- UL Flammability Classification Rating 94V-0
- Moisture Sensitivity: Level 1 per J-STD-020
- Terminal Connections: See Diagram Below
- Marking Information: See Below

### Dimensions DFN2510P10



### Pin Configuration

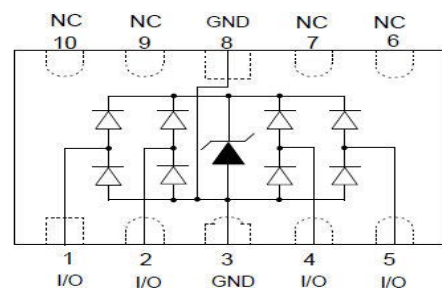

### Marking Information



0524S = Device Marking  
Code YYWW = Code  
Dot denotes Pin1

### Ordering Information

Part Number	Packaging	Reel Size
LM-ESDA6V8UD-10	3000/Tape & Reel	7 inch

## Absolute Maximum Ratings ( $T_A=25^{\circ}\text{C}$ unless otherwise specified)

Parameter	Symbol	Value	Unit
Peak Pulse Power (8/20 $\mu\text{s}$ )	Ppk	75	W
Peak Pulse Current (8/20 $\mu\text{s}$ )	I <sub>PP</sub>	5	A
ESD per IEC 61000-4-2 (Air)	V <sub>ESD</sub>	$\pm 30$	kV
ESD per IEC 61000-4-2 (Contact)		$\pm 25$	
Operating Temperature Range	T <sub>J</sub>	-55 to +125	$^{\circ}\text{C}$
Storage Temperature Range	T <sub>stg</sub>	-55 to +150	$^{\circ}\text{C}$

## Electrical Characteristics ( $T_A=25^{\circ}\text{C}$ unless otherwise specified)

Parameter	Symbol	Min	Typ	Max	Unit	Test Condition
Reverse Working Voltage	V <sub>RWM</sub>			5	V	Any I/O pin to ground
Breakdown Voltage	V <sub>BR</sub>	6			V	I <sub>T</sub> = 1mA, any I/O pin to ground
Reverse Leakage Current	I <sub>R</sub>			0.1	$\mu\text{A}$	V <sub>RWM</sub> = 5V, any I/O pin to ground
Clamping Voltage	V <sub>C</sub>			9.8	V	I <sub>PP</sub> = 1A (8 x 20 $\mu\text{s}$ pulse), any I/O pin to ground
Clamping Voltage	V <sub>C</sub>			15	V	I <sub>PP</sub> = 5A (8 x 20 $\mu\text{s}$ pulse), any I/O pin to ground
Junction Capacitance	C <sub>J</sub>		0.3	0.4	pF	V <sub>R</sub> = 0V, f = 1MHz, between I/O pins
Junction Capacitance	C <sub>J</sub>			0.8	pF	V <sub>R</sub> = 0V, f = 1MHz, any I/O pin to ground

## Typical Performance Characteristics ( $T_A=25^\circ\text{C}$ unless otherwise Specified)

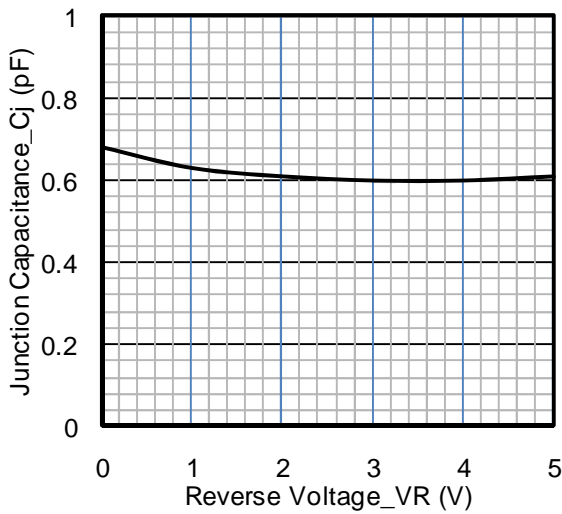

**Junction Capacitance vs. Reverse Voltage**

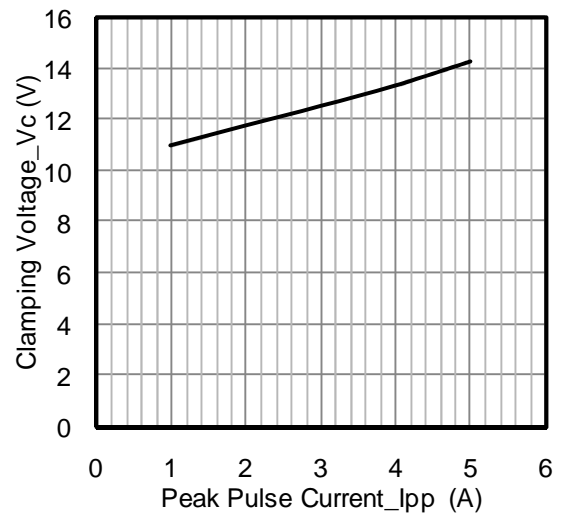

**Clamping Voltage vs. Peak Pulse Current**

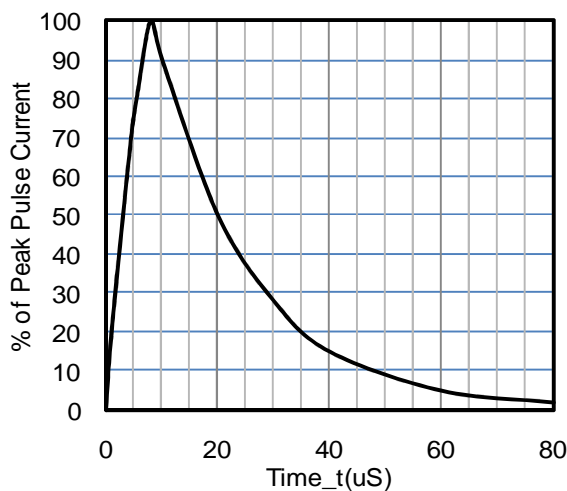

**8 X 20uS Pulse Waveform**



**Power Derating Curve**

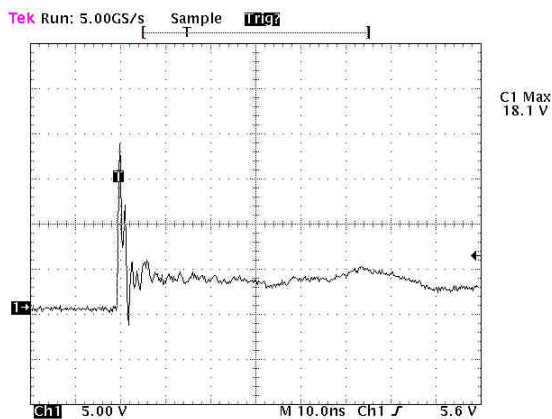

**ESD Clamping Voltage**

8 kV Contact per IEC61000-4-2

## Typical Application

The LM-ESDA6V8UD-10 is designed for easy PCB layout by allowing the traces to run straight through the device. The PCB traces could be used to connect the pin pairs for each line. For example, line 1 enters at pin 1 and exits at pin 10 and the PCB trace connects Pin 1 and Pin 10 together. Ground is connected at Pin 3 and Pin 8.



## LM-ESDA6V8UD-10 on USB 3.0 Port Application



## LM-ESDA6V8UD-10 on DVI Port Application



## LM-ESDA6V8UD-10 on HDMI Port Application



## LM-ESDA6V8UD-10 on VGA Port Application



## LM-ESDA6V8UD-10 on eSATA Port Application



## LM-ESDA6V8UD-10 on MDDI Port Application

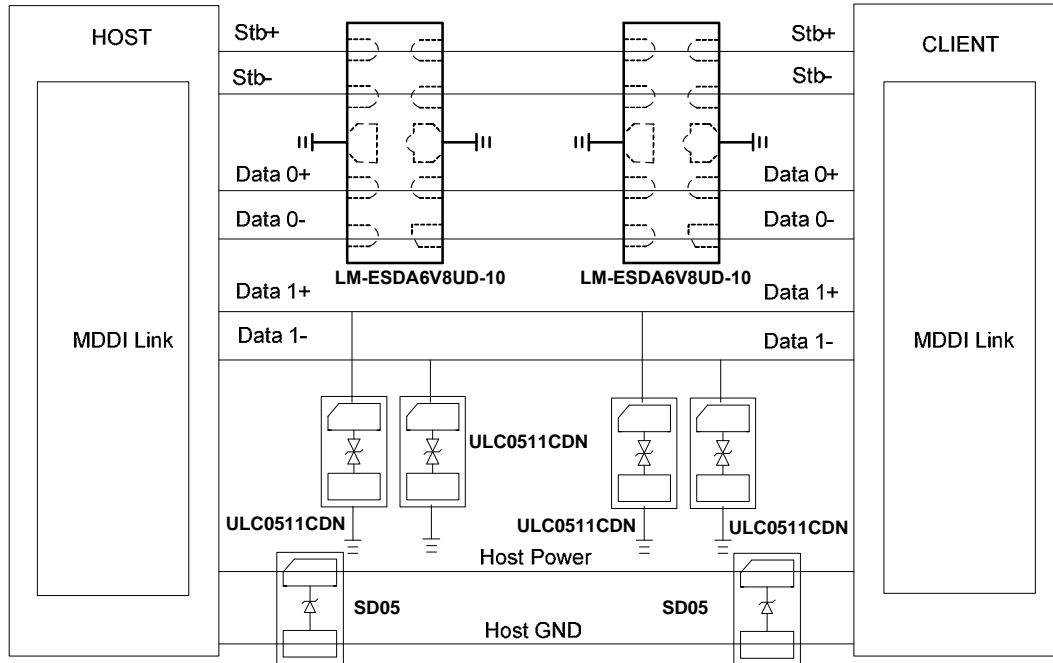

## LM-ESDA6V8UD-10 on 10/100 Base Ethernet Port Application





## DFN2510-10 Package Outline Drawing

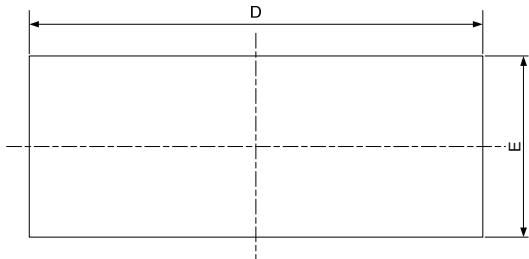

TOP VIEW

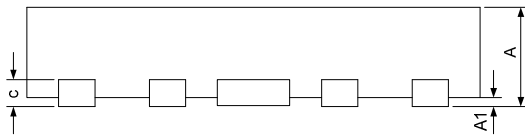

SIDE VIEW

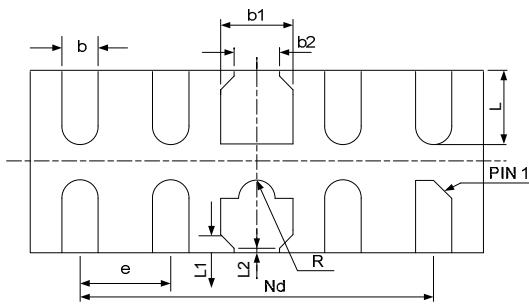

BOTTOM VIEW

SYM	DIMENSIONS					
	MILLIMETERS			INCHES		
	MIN	NOM	MAX	MIN	NOM	MAX
A	0.45	0.50	0.55	0.018	0.020	0.022
A1	0.00	0.02	0.05	0.000	0.001	0.002
b	0.15	0.20	0.25	0.006	0.008	0.010
b1	0.35	0.40	0.45	0.014	0.016	0.018
b2	0.20	0.25	0.30	0.008	0.010	0.012
c	0.10	0.15	0.20	0.004	0.006	0.008
D	2.45	2.50	2.55	0.098	0.100	0.102
e	0.50BSC			0.020BSC		
Nd	2.00BSC			0.080BSC		
E	0.95	1.00	1.05	0.038	0.040	0.042
L	0.35	0.40	0.45	0.014	0.016	0.018
L1	0.075REF			0.003REF		
L2	0.050REF			0.002REF		
h	0.08	0.12	0.15	0.003	0.005	0.006
R	0.05	0.10	0.15	0.002	0.004	0.006

## Suggested Land Pattern

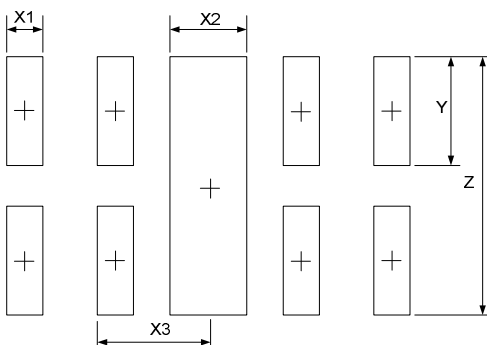

SYM	DIMENSIONS	
	MILLIMETERS	INCHES
X1	0.200	0.008
X2	0.400	0.016
X3	0.500	0.020
Y	0.600	0.024
Z	1.400	0.056