

FEATURES

- Inherently Matched LED Current
- Drives Up to 27 LEDs from a 5V Supply
- 36V Rugged Bipolar Switch
- Fast 1.3MHz Switching Frequency
- Variable Dead-Time Provides Control over Total Range
- $V_{OVP(MAX)} = 29V$
- Moisture Sensitivity Level 3
- Available in SOT-23-6 Package

APPLICATION

- Cellular Phones
- PDAs, Handheld Computers
- 36V Rugged Bipolar Switch
- MP3 Players
- GPS Receivers

DESCRIPTION

The LM1938 is a step-up DC/DC converter specifically designed to drive white LEDs with a constant current. The device can drive up to 27 LEDs from a 5V supply. Additional features include output voltage limiting when LEDs are disconnected.

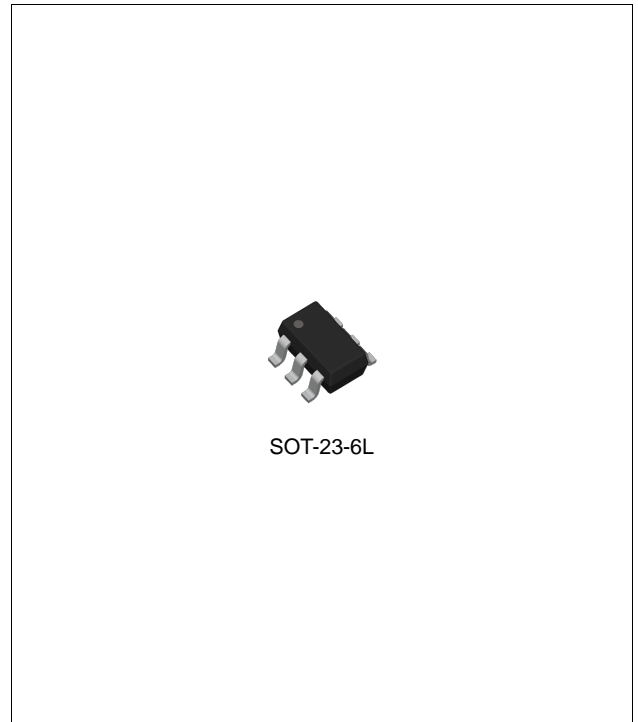

ORDERING INFORMATION

Device	Package
LM1938SF6	SOT-23-6L

ABSOLUTE MAXIMUM RATINGS (Note 1)

CHARACTERISTIC	SYMBOL	MIN	MAX	UNIT
IN Voltage	V_{IN}	-0.3	10	V
SW voltage	V_{SW}	-0.3	36	V
FB Voltage	V_{FB}	-0.3	10	V
\overline{SHDN} Voltage	V_{EN}	-0.3	10	V
Operating Temperature Range	T_{OPR}	-40	85	°C
Junction Temperature Range	T_J	-40	125	°C
Storage Temperature Range	T_{STG}	-65	150	°C

Note 1. Absolute Maximum Ratings are those values beyond which the life of the device may be impaired.

ORDERING INFORMATION

Package	Order No.	Description	Supplied As	Status
SOT-23-6L	LM1938SF6	Over Voltage Protection, Enable	Tape & Reel	Active

PIN CONFIGURATION

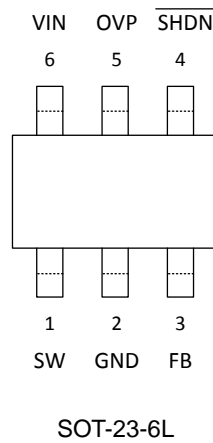

PIN DESCRIPTION

Pin No.	Pin Name	Pin Function
1	SW	Switching Pin. This is the collector of the internal NPN power switch. Connect to inductor and diode. Minimize the metal trace area connected to this pin to reduce EMI.
2	GND	Ground Pin. Connect directly to local ground plane.
3	FB	Feedback Pin. Reference voltage is 95mV. Connect LEDs and a resistor at this pin.
4	$\overline{\text{SHDN}}$ (EN)	IC Enable Control. Active High. Connect to 1.5V or higher to enable device. 0.4V or less to disable device.
5	OVP	Over Voltage Protection. Float the pin if not used.
6	VIN	Input Supply Pin. Bypass this pin with a capacitor as close to the device as possible.

BLOCK DIAGRAM

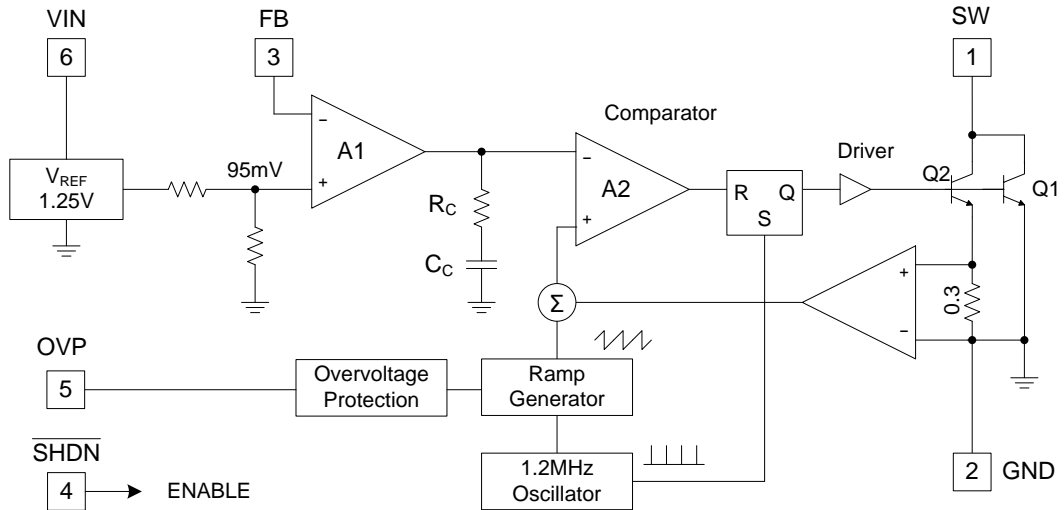

TYPICAL APPLICATION CIRCUIT

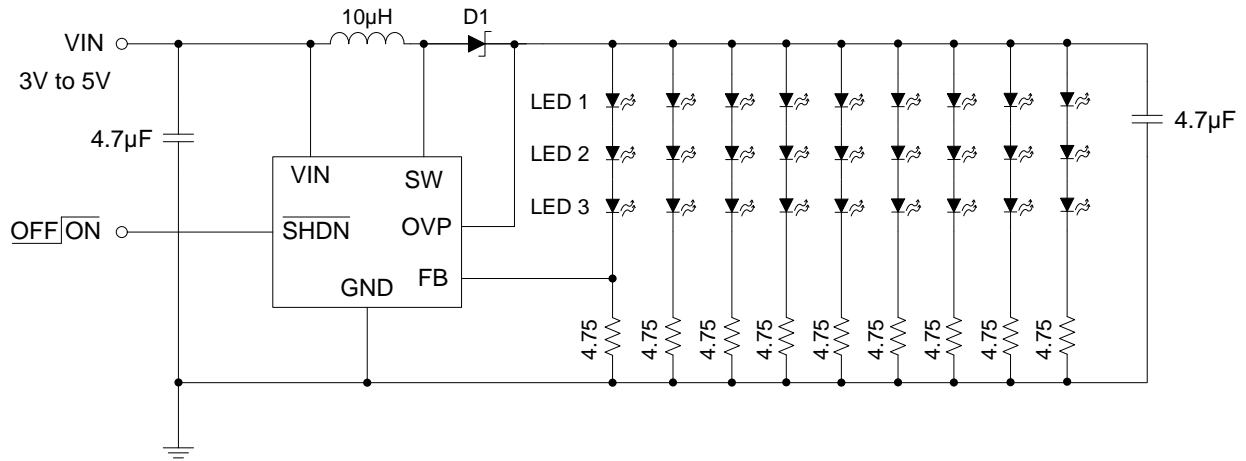

Li-Ion Powered Driver for 27 White LEDs

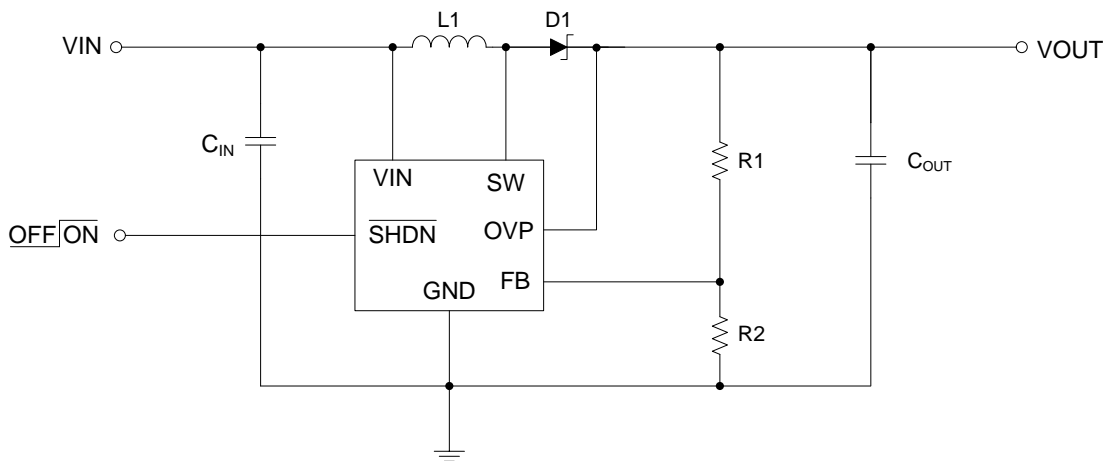

$$V_{OUT} = V_{FB} \left(1 + \frac{R1}{R2} \right), \text{ where } V_{FB} = 95 \text{ mV}$$

Powered Driver for Step-Up Converter

ELECTRICAL CHARACTERISTICS

$T_A = 25^\circ\text{C}$, $V_{IN} = 5\text{V}$, $V_{\overline{\text{SHDN}}} = 5\text{V}$, unless otherwise noted.

PARAMETER	SYMBOL	TEST CONDITIONS	MIN	TYP	MAX	UNIT
Operating Voltage Range	V_{IN}		2.5	-	10	V
Feedback Voltage	V_{FB}	$I_{LOAD} = 100\text{ mA}$, $V_{IN} = 5.0\text{ V}$	86	95	104	mV
		$I_{LOAD} = 180\text{ mA}$, $V_{IN} = 5.0\text{ V}$	83	95	107	mV
Feedback Pin Bias Current	I_{FB}		10	45	100	nA
Supply Current	I_{CC}		-	2.1	3.0	mA
Standby Supply Current	I_{STBY}	$\overline{\text{SHDN}} = 0\text{ V}$	-	0.1	1.0	μA
Switching Frequency	f_{SW}		1.1	1.3	1.6	MHz
Maximum Duty Cycle	D_{MAX}		85	90	-	%
Switch Current Limit	I_{CL}		-	650	-	mA
Switch Saturation Voltage	V_{CESAT}	$I_{SW} = 250\text{ mA}$	-	350	-	mV
Switch Leakage Current	I_{LEAK}	$V_{SW} = 5.0\text{ V}$	-	0.01	5.0	μA
$\overline{\text{SHDN}}$ Voltage High	V_{ENH}		1.5	-	-	V
$\overline{\text{SHDN}}$ Voltage Low	V_{ENL}		-	-	0.4	V
$\overline{\text{SHDN}}$ Pin Bias Current	I_{EN}		-	65	-	μA
OVP Threshold	V_{OVP}		-	29	-	V

TYPICAL OPERATING CHARACTERISTICS

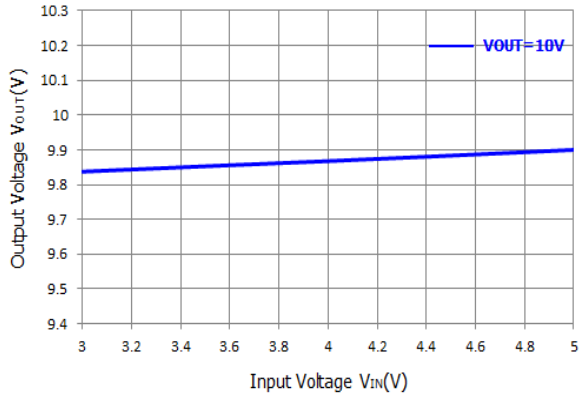

Output Voltage vs Input Voltage (VOUT=10V)

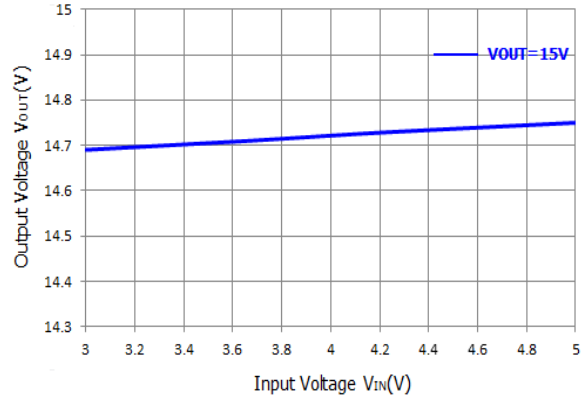

Output Voltage vs Input Voltage (VOUT=15V)

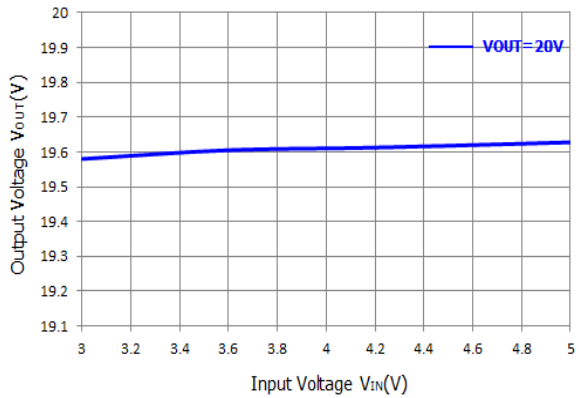

Output Voltage vs Input Voltage (VOUT=20V)

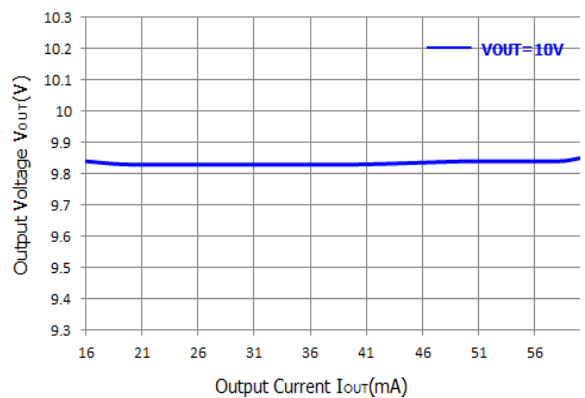

Output Voltage vs Output Current (VIN=3.0V)

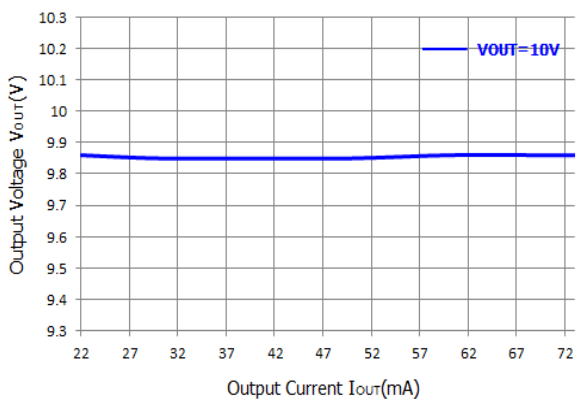

Output Voltage vs Output Current (VIN=3.6V)

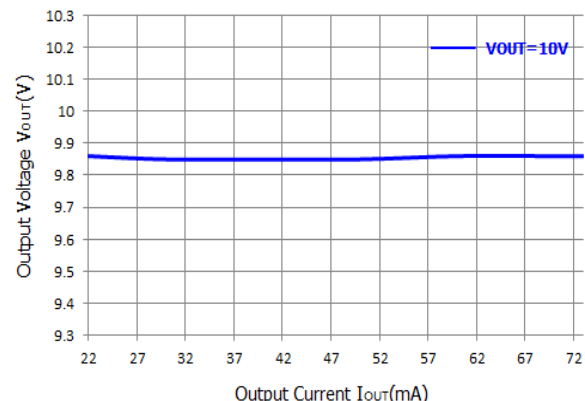

Output Voltage vs Output Current (VIN=4.2V)

TYPICAL OPERATING CHARACTERISTICS (Continued)

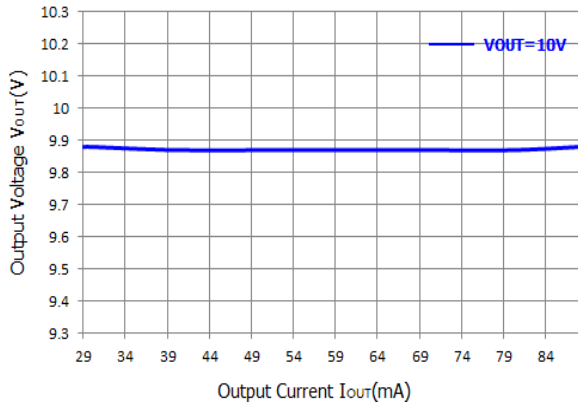

Output Voltage vs Output Current (VIN=5.0V)

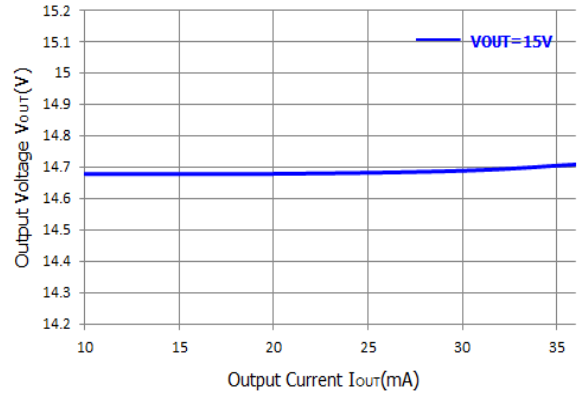

Output Voltage vs Output Current (VIN=3.0V)

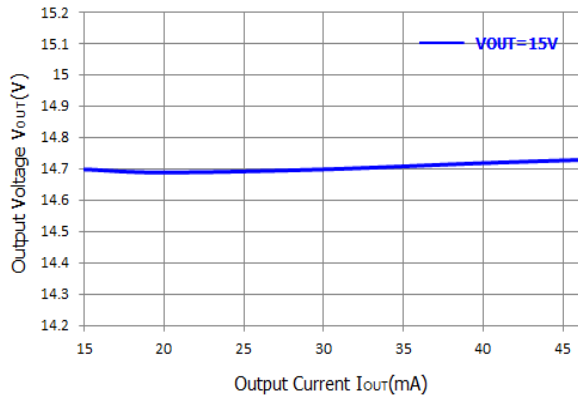

Output Voltage vs Output Current (VIN=3.6V)

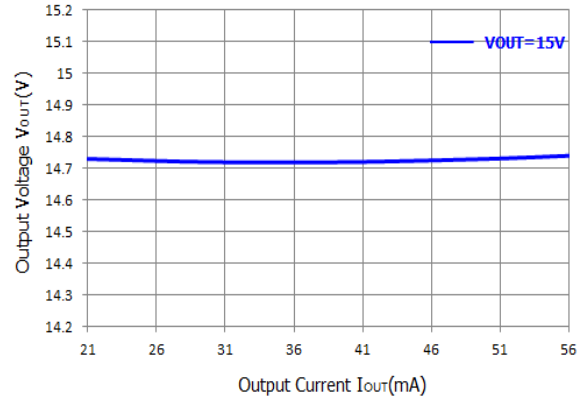

Output Voltage vs Output Current (VIN=4.2V)

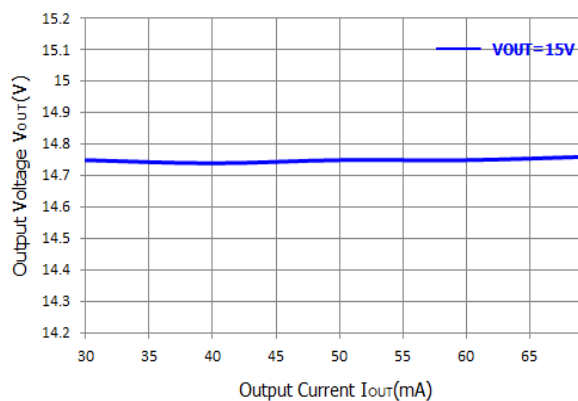

Output Voltage vs Output Current (VIN=5.0V)

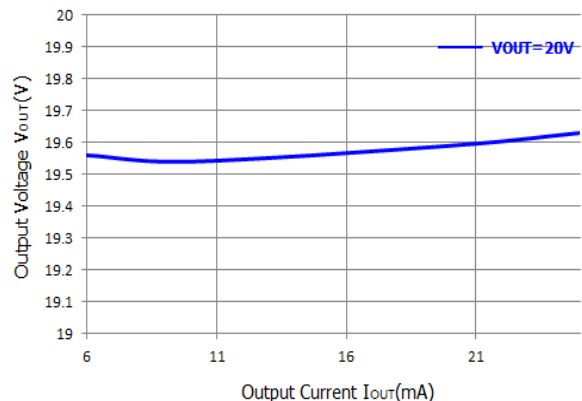

Output Voltage vs Output Current (VIN=3.0V)

TYPICAL OPERATING CHARACTERISTICS (Continued)

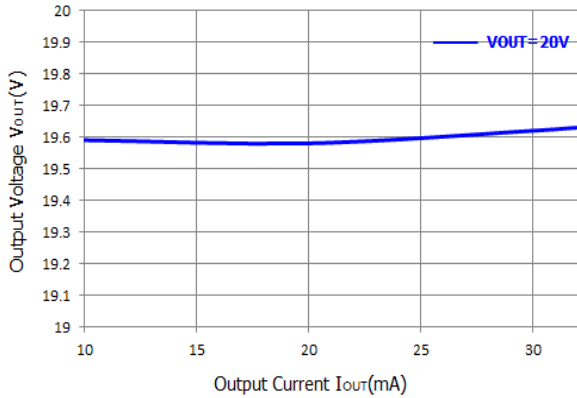

Output Voltage vs Output Current (VIN=3.6V)

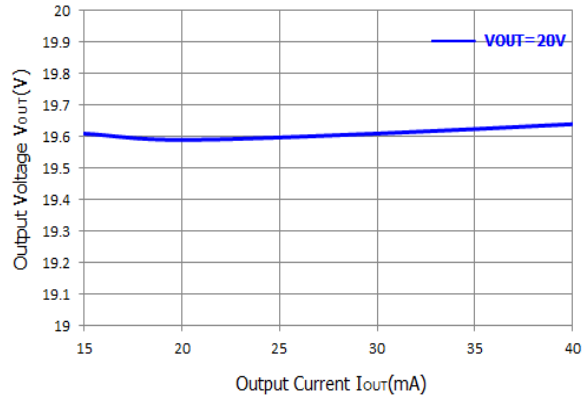

Output Voltage vs Output Current (VIN=4.2V)

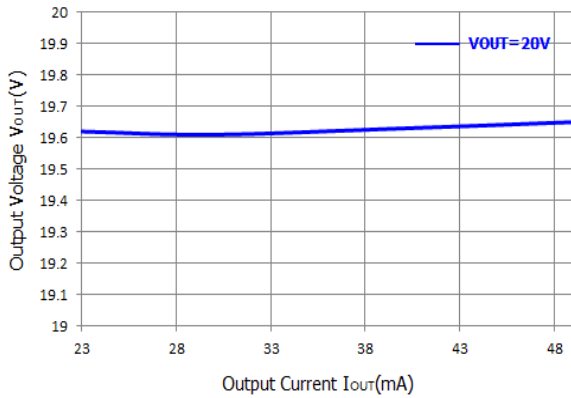

Output Voltage vs Output Current (VIN=5.0V)

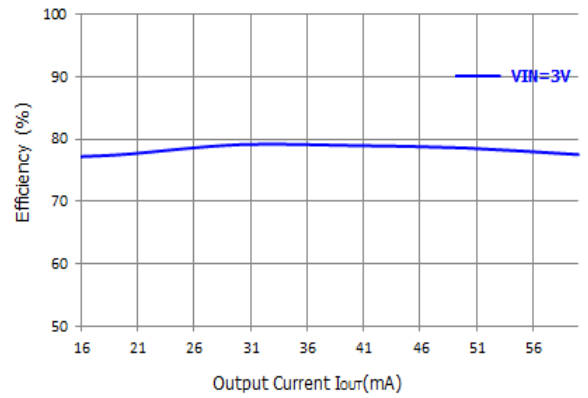

Efficiency vs Output Current (VOUT=10V)

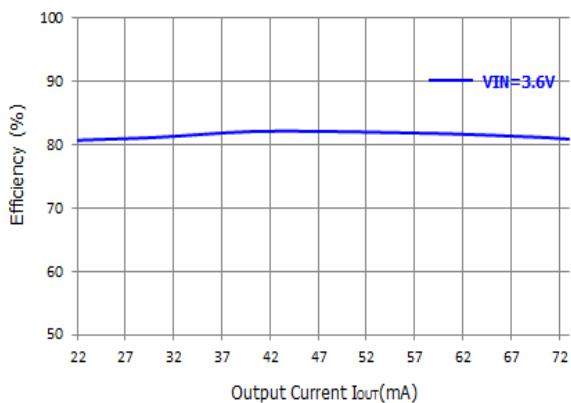

Efficiency vs Output Current (VOUT=10V)

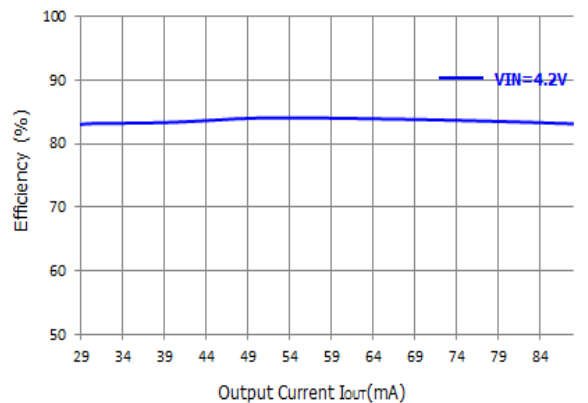

Efficiency vs Output Current (VOUT=10V)

TYPICAL OPERATING CHARACTERISTICS (Continued)

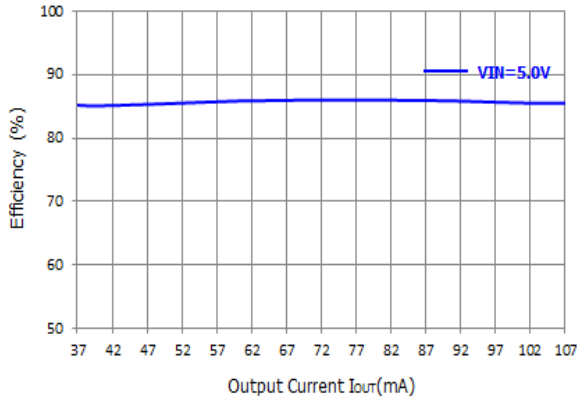

Efficiency vs Output Current (VOUT=10V)

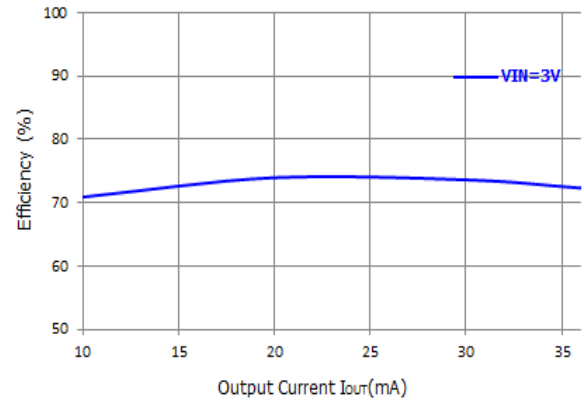

Efficiency vs Output Current (VOUT=15V)

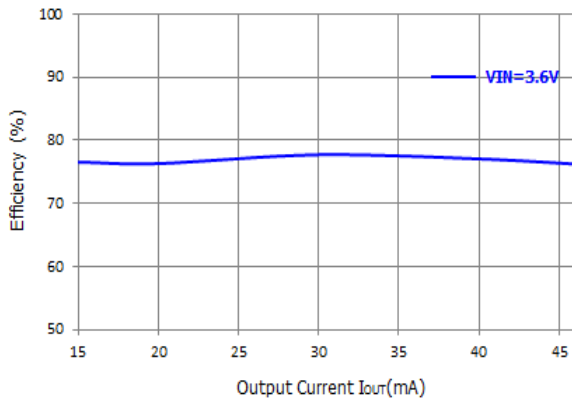

Efficiency vs Output Current (VOUT=15V)

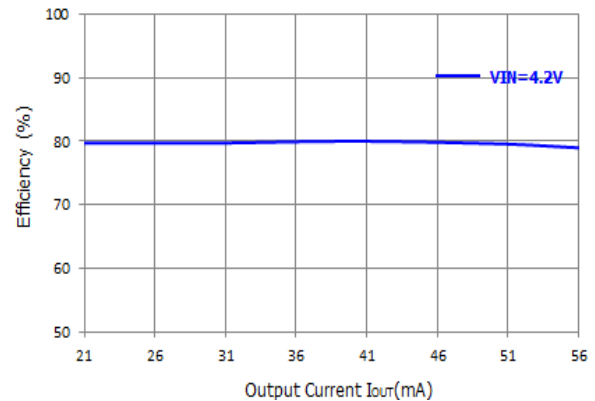

Efficiency vs Output Current (VOUT=15V)

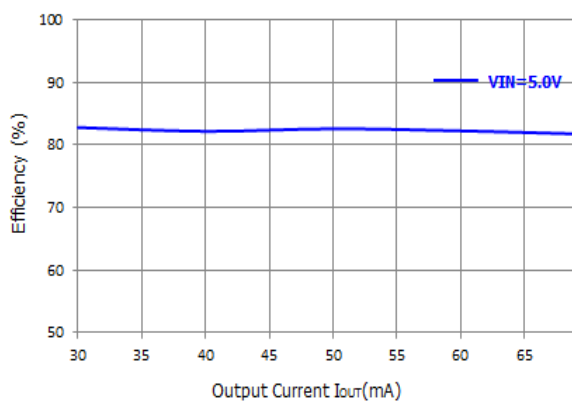

Efficiency vs Output Current (VOUT=15V)

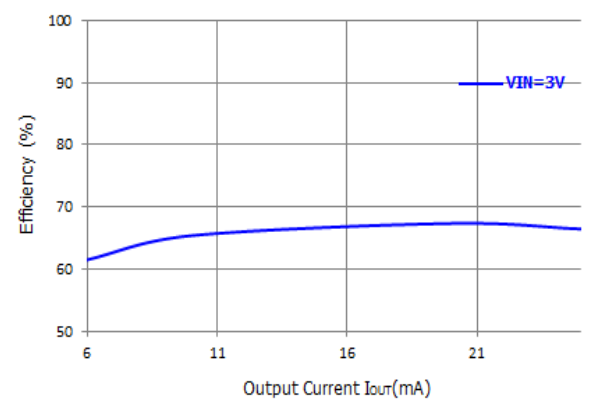

Efficiency vs Output Current (VOUT=20V)

TYPICAL OPERATING CHARACTERISTICS (Continued)

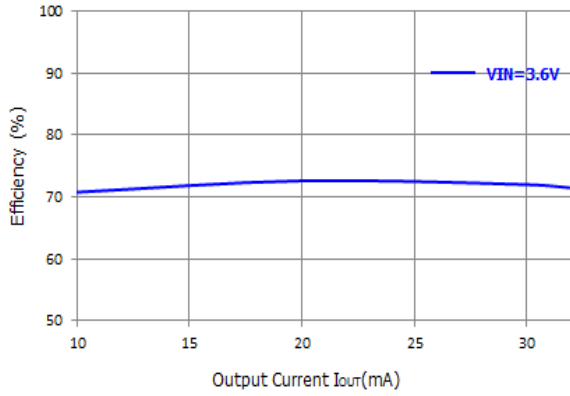

Efficiency vs Output Current (VOUT=20V)

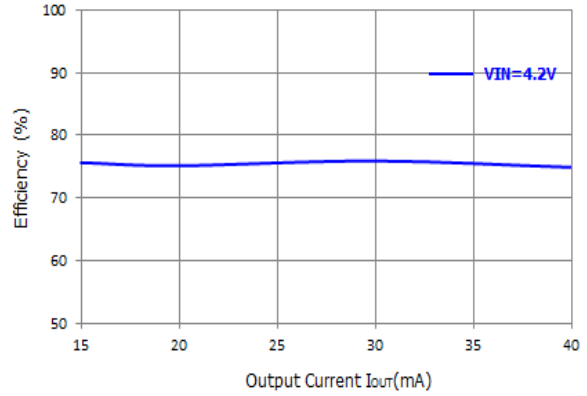

Efficiency vs Output Current (VOUT=20V)

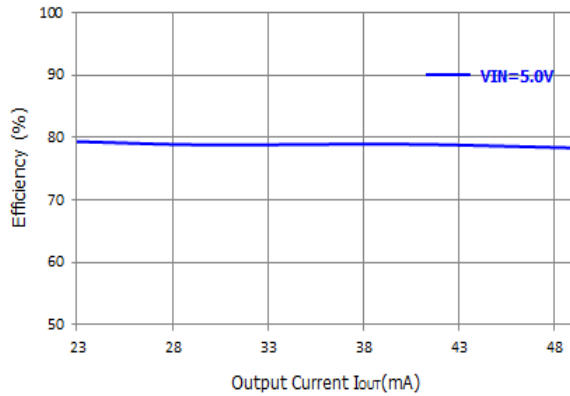

Efficiency vs Output Current (VOUT=20V)

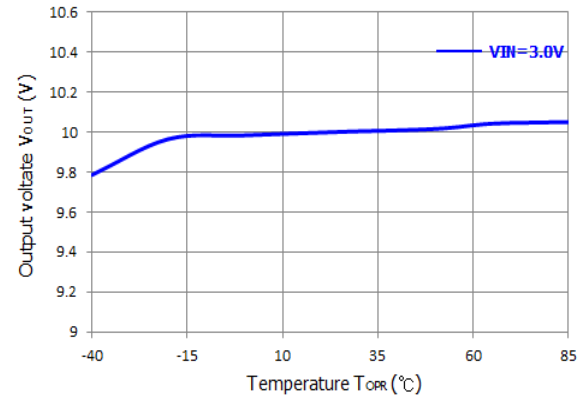

Output voltage vs Temperature (VOUT=10V)

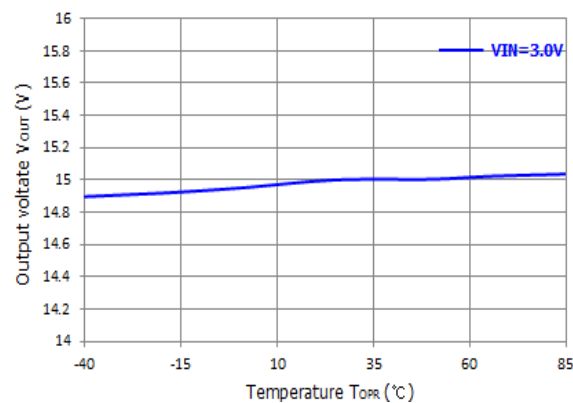

Output voltage vs Temperature (VOUT=15V)

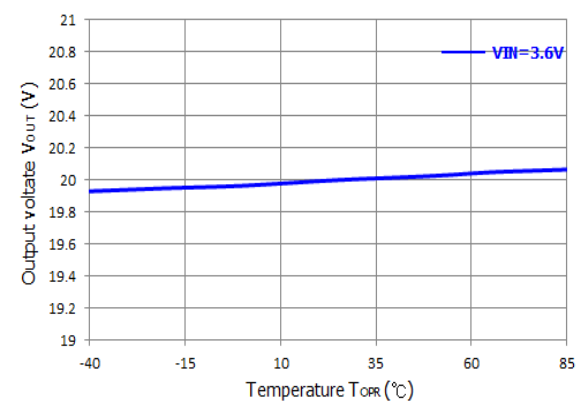

Output voltage vs Temperature (VOUT=20V)

TYPICAL OPERATING CHARACTERISTICS (Continued)

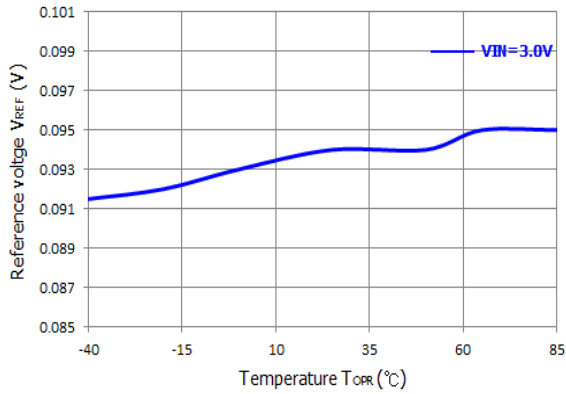

Reference voltage vs Temperature (VOUT=10V)

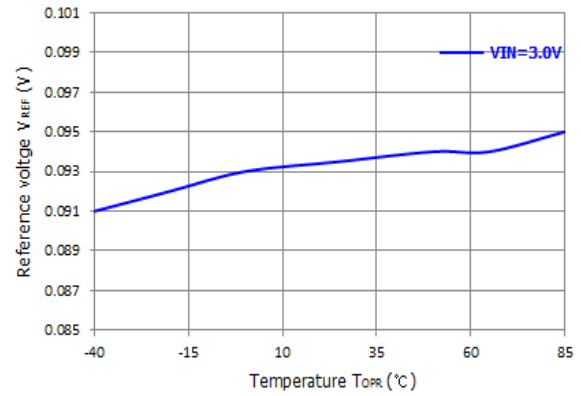

Reference voltage vs Temperature (VOUT=15V)

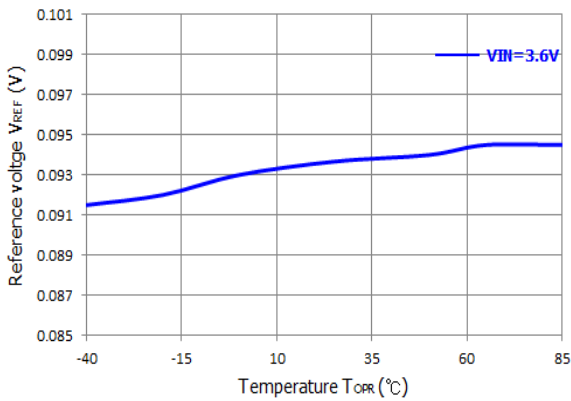

Reference voltage vs Temperature (VOUT=20V)

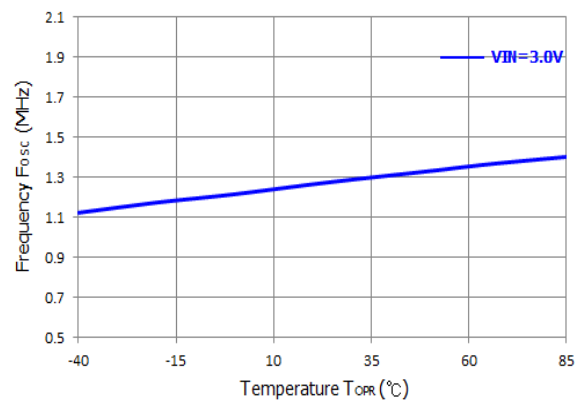

Oscillator Frequency vs Temperature (VOUT=10V)

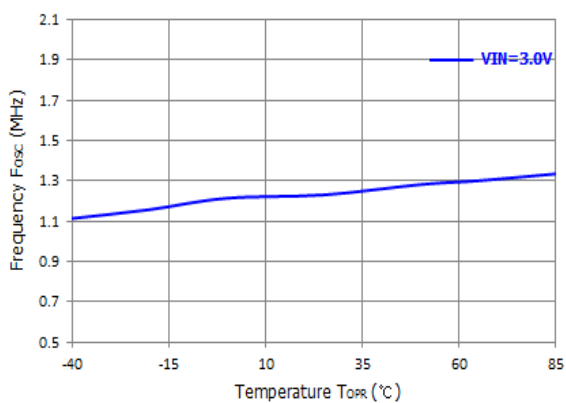

Oscillator Frequency vs Temperature (VOUT=15V)

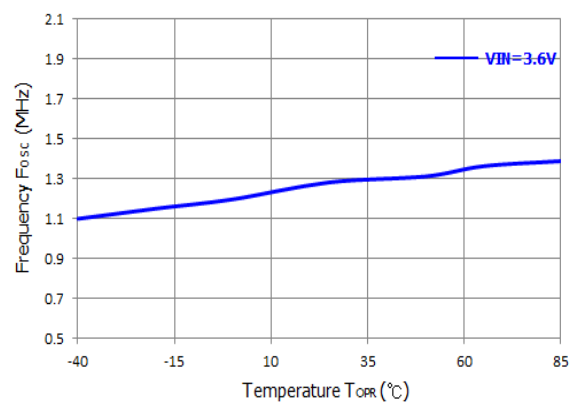

Oscillator Frequency vs Temperature (VOUT=20V)

TYPICAL OPERATING CHARACTERISTICS (Continued)

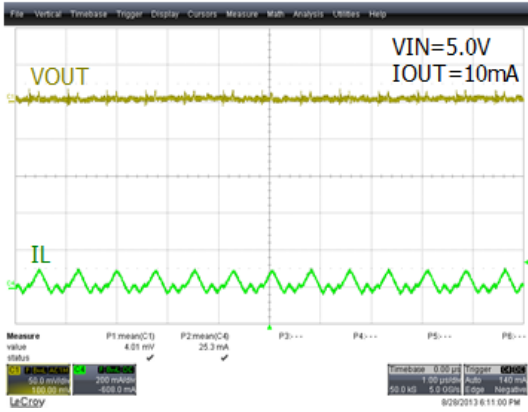

Output Waveform (VOUT=10V)

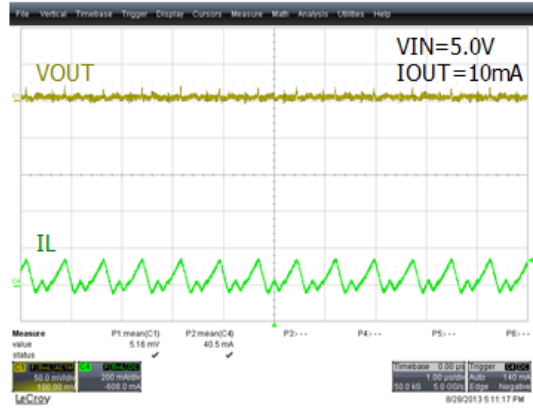

Output Waveform (VOUT=15V)

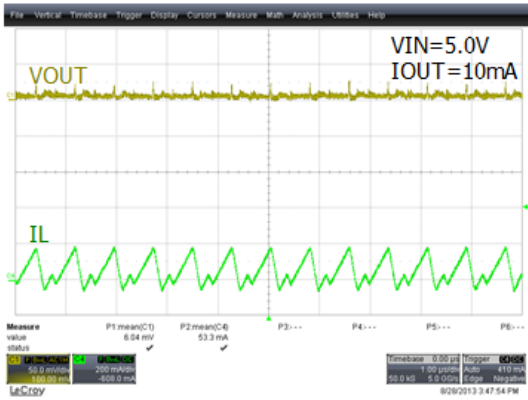

Output Waveform (VOUT=20V)

APPLICATION INFORMATION

OVERVIEW

The LM1938 uses a constant frequency, current mode control scheme to provide excellent line and load regulation. Operation can be best understood by referring to the Block Diagram. At the start of each oscillator cycle, the RS latch is set, which turns on the power switch Q1. A voltage proportional to the switch current is added to a stabilizing ramp and the resulting sum is fed into the positive terminal of the PWM comparator A2. When this voltage exceeds the level at the negative input of A2, the RS latch is reset turning off the power switch. The level at the negative input of A2 is set by the error amplifier A1, and is simply an amplified version of the difference between the feedback voltage and the reference voltage of 95mV. In this manner, the error amplifier sets the correct peak current level to keep the output in regulation. If the error amplifier's output increases, more current is delivered to the output; if it decreases, less current is delivered.

INDUCTOR SELECTION

A 10µH inductor is recommended for most LM1938 applications. Although small size and high efficiency are major concerns, the inductor should have low core losses at 1.3 MHz and low DCR (wire resistance).

CAPACITOR SELECTION

The small size of ceramic capacitors makes them ideal for LM1938 applications. X5R and X7R types are recommended because they retain their capacitance over wider voltage and temperature ranges than other types such as Y5V or Z5U. A 4.7µF input capacitor and a 4.7µF output capacitor are sufficient for most LM1938 applications.

DIODE SELECTION

Schottky diodes, with their low forward voltage drop and fast reverse recovery, are the ideal choices for LM1938 applications. The forward voltage drop of a Schottky diode represents the conduction losses in the diode, while the diode capacitance represents the switching losses. For diode selection, both forward voltage drop and diode capacitance need to be considered. Schottky diodes with higher current ratings usually have lower forward voltage drop and larger diode capacitance, which can cause significant switching losses at the 1.3 MHz switching frequency of the LM1938. A Schottky diode rated at 1000mA is sufficient for most LM1938 applications.

LED CURRENT CONTROL

The LED current is controlled by the feedback resistor (R1 in Typical Application Circuit). The feedback reference is 95mV. The LED current is $95\text{mV} / R1$. In order to have accurate LED current, precision resistors are preferred (1% is recommended). The formula and table for R1 selection are shown below.

$$R1 = \frac{95\text{mV}}{I_{\text{LED}}}$$

I_{LED}	R1
5 mA	19.1 ohm
10 mA	9.53 ohm
12 mA	7.87 ohm
15 mA	6.34 ohm
20 mA	4.75 ohm

DIMMING CONTROL

There are some different types of dimming control circuits:

Using a PWM Signal to $\overline{\text{SHDN}}$ Pin

With the PWM signal applied to the $\overline{\text{SHDN}}$ pin, the LM1938 is turned on or off by the PWM signal. The LEDs operate at either zero or full current. The average LED current increases proportionally with the duty cycle of the PWM signal. A 0% duty cycle will turn off the LM1938 and corresponds to zero LED current. A 100% duty cycle corresponds to full current. The typical frequency range of the PWM signal is 1.0 kHz to 10 kHz. The magnitude of the PWM signal should be higher than the minimum $\overline{\text{SHDN}}$ voltage high.

Using a DC Voltage

For some applications, the preferred method of brightness control is a variable DC voltage to adjust the LED current. The dimming control using a DC voltage is shown in figure below. As the DC voltage increases, the voltage drop on R2 increases and the voltage drop on R1 decreases. Thus, the LED current decreases. The selection of R2 and R3 will make the current from the variable DC source much smaller than the LED current and much larger than the FB pin bias current. For V_{DC} range from 0V to 2.0V, the selection of resistors in the figure gives dimming control of LED current from 0mA to 15mA.

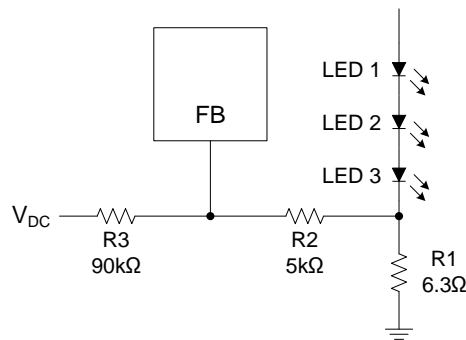

Dimming Control Using a DC Voltage

Using a Filtered PWM Signal

The filtered PWM signal can be considered as an adjustable DC voltage. It can be used to replace the variable DC voltage source in dimming control. The circuit is shown in figure below.

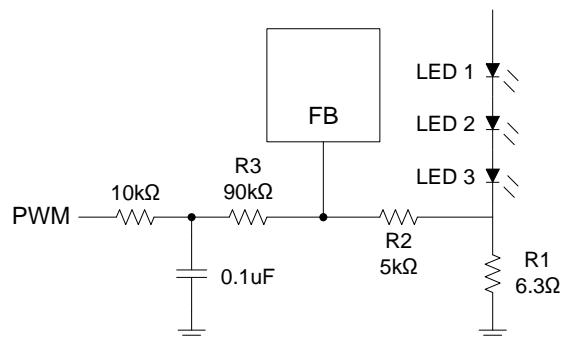

Dimming Control Using a Filtered PWM Signal

REVISION NOTICE

The description in this datasheet is subject to change without any notice to describe its electrical characteristics properly.