

## LM1973 $\mu$ Pot3-Channel 76dB Audio Attenuator with Mute

Check for Samples: [LM1973](#)

### FEATURES

- 3-Wire Serial Interface
- Daisy-Chain Capability
- 104dB Mute Attenuation
- Pop and Click Free Attenuation Changes

### APPLICATIONS

- Automated Studio Mixing Consoles
- Music Reproduction Systems
- Sound Reinforcement Systems
- Electronic Music (MIDI)
- Personal Computer Audio Control

### KEY SPECIFICATIONS

- Total Harmonic Distortion + Noise: 0.003 % (max)
- Frequency response: 100 kHz (–3dB) (min)
- Attenuation range (excluding mute): 76 dB (typ)
- Differential attenuation:  $\pm 0.25$  dB (max)
- Signal-to-noise ratio (ref. 4 Vrms): 110 dB (min)
- Channel separation: 110 dB (typ)

### TYPICAL APPLICATION

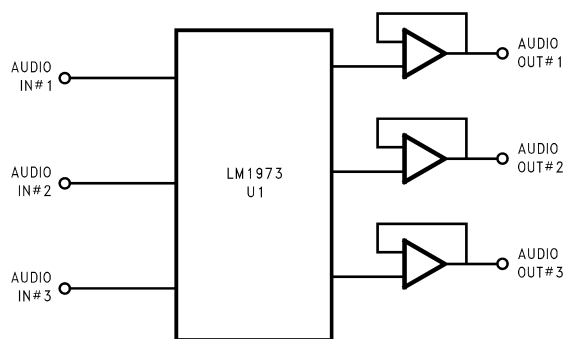

**Figure 1. Typical Audio Attenuator Application Circuit**

### DESCRIPTION

The LM1973 is a digitally controlled 3-channel 76dB audio attenuator fabricated on a CMOS process. Each channel has attenuation steps of 0.5dB from 0dB–15.5dB, 1.0dB steps from 16dB–47dB, and 2.0dB steps from 48dB–76dB, with a mute function attenuating 104dB. Its logarithmic attenuation curve can be customized through software to fit the desired application.

The performance of a  $\mu$ Pot is demonstrated through its excellent Signal-to-Noise Ratio, extremely low (THD+N), and high channel separation. Each  $\mu$ Pot contains a mute function that disconnects the input signal from the output, providing a minimum attenuation of 96dB. Transitions between any attenuation settings are pop free.

The LM1973's 3-wire serial digital interface is TTL and CMOS compatible; receiving data that selects a channel and the desired attenuation level. The Data-Out pin of the LM1973 allows multiple  $\mu$ Pots to be daisy-chained together, reducing the number of enable and data lines to be routed for a given application.

### CONNECTION DIAGRAM

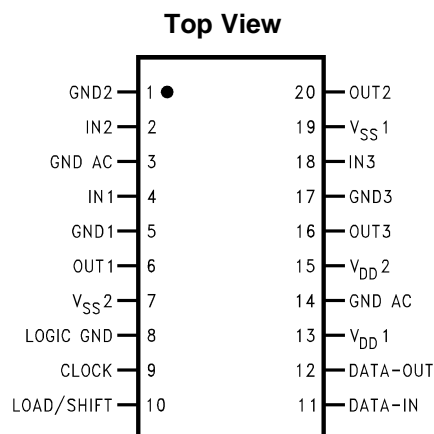

**Figure 2. PDIP and SOIC Packages  
See Package Numbers NFH0020A and DW0020B**



Please be aware that an important notice concerning availability, standard warranty, and use in critical applications of Texas Instruments semiconductor products and disclaimers thereto appears at the end of this data sheet.

All trademarks are the property of their respective owners.



These devices have limited built-in ESD protection. The leads should be shorted together or the device placed in conductive foam during storage or handling to prevent electrostatic damage to the MOS gates.

### ABSOLUTE MAXIMUM RATINGS <sup>(1)(2)(3)</sup>

Supply Voltage ( $V_{DD}-V_{SS}$ )		15V
Voltage at Any Pin		$V_{SS} - 0.2V$ to $V_{DD} + 0.2V$
Power Dissipation <sup>(4)</sup>		150 mW
ESD Susceptibility <sup>(5)</sup>		1800V
Junction Temperature		150°C
Soldering Information	NFH0020A Package (10 sec.)	+260°C
Storage Temperature		-65°C to +150°C

- (1) All voltages are measured with respect to GND (pins 1, 3, 5, 14, 17), unless otherwise specified.
- (2) *Absolute Maximum Ratings* indicate limits beyond which damage to the device may occur. *Operating Ratings* indicate conditions for which the device is functional, but do not guarantee specific performance limits. *Electrical Characteristics* state DC and AC electrical specifications under particular test conditions which guarantee specific performance limits. This assumes that the device is within the Operating Ratings. Specifications are not guaranteed for parameters where no limit is given, however, the typical value is a good indication of device performance.
- (3) If Military/Aerospace specified devices are required, please contact the Texas Instruments Sales Office/ Distributors for availability and specifications.
- (4) The maximum power dissipation must be derated at elevated temperatures and is dictated by  $T_{JMAX}$ ,  $\theta_{JA}$ , and the ambient temperature  $T_A$ . The maximum allowable power dissipation is  $PD = (T_{JMAX} - T_A)/\theta_{JA}$  or the number given in the Absolute Maximum Ratings, whichever is lower. For the LM1973N,  $T_{JMAX} = +150^\circ\text{C}$ , and the typical junction-to-ambient thermal resistance, when board mounted, is  $65^\circ\text{C/W}$ .
- (5) Human body model, 100 pF discharged through a 1.5 k $\Omega$  resistor.

### OPERATING RATINGS <sup>(1)(2)</sup>

	$T_{MIN}$	$T_A$	$T_{MAX}$
Temperature Range	$T_{MIN} \leq T_A \leq T_{MAX}$		$0^\circ\text{C}$
Supply Voltage ( $V_{DD} - V_{SS}$ )		$\leq T_A$	$\leq +70^\circ\text{C}$
			4.5V to 12V

- (1) *Absolute Maximum Ratings* indicate limits beyond which damage to the device may occur. *Operating Ratings* indicate conditions for which the device is functional, but do not guarantee specific performance limits. *Electrical Characteristics* state DC and AC electrical specifications under particular test conditions which guarantee specific performance limits. This assumes that the device is within the Operating Ratings. Specifications are not guaranteed for parameters where no limit is given, however, the typical value is a good indication of device performance.
- (2) All voltages are measured with respect to GND (pins 1, 3, 5, 14, 17), unless otherwise specified.

**ELECTRICAL CHARACTERISTICS** <sup>(1)(2)</sup>

The following specifications apply for all channels with  $V_{DD} = +6V$ ,  $V_{SS} = -6V$ ,  $V_{IN} = 5.5$  Vpk, and  $f = 1$  kHz, unless otherwise specified. Limits apply for  $T_A = 25^\circ C$ . Digital inputs are TTL and CMOS compatible.

Parameter		Test Conditions	LM1973		Units (Limits)	
			Typical <sup>(3)</sup>	Limit <sup>(4)</sup>		
$I_S$	Supply Current	Inputs are AC Grounded	3	5	mA (max)	
THD+N	Total Harmonic Distortion plus Noise	$V_{IN} = 0.5$ Vpk at 0dB Attenuation	0.0008	0.003	% (max)	
XTalk	Crosstalk (Channel Separation)	0dB Attenuation for $V_{IN}$	110		dB	
	<sup>(5)</sup>	$V_{CH}$ measured at -76dB				
SNR	Signal-to-Noise Ratio	Inputs are AC Grounded at -12dB Attenuation A-Weighted	120	110	dB (min)	
$A_M$	Mute Attenuation		104	96	dB (min)	
	Attenuation Step Size Error	0dB to -16dB		$\pm 0.05$	dB (max)	
		-17dB to -48dB		$\pm 0.1$	dB (max)	
		-49dB to -76dB		$\pm 0.25$	dB (max)	
	Absolute Attenuation Error	Attenuation at 0dB		0.01	0.5	dB (min)
		Attenuation at -20dB		19.8	19.0	dB (min)
		Attenuation at -40dB		39.5	38.5	dB (min)
Attenuation at -60dB			59.3	58.0	dB (min)	
Attenuation at -76dB			74.5	73.0	dB (min)	
Channel-to-Channel Attenuation	Attenuation at 0dB, -20dB, -40dB, -60dB			$\pm 0.5$	dB (max)	
Tracking Error	Attenuation at -76dB			$\pm 0.75$	dB (max)	
$I_{LEAK}$	Analog Input Leakage Current	Inputs are AC Grounded	10.0	100	nA (max)	
$R_{IN}$	AC Input Impedance	Pins 2, 4, 18, $V_{IN} = 1.0$ Vpk, $f = 1$ kHz	40	20	k $\Omega$ (min)	
				60	k $\Omega$ (max)	
$I_{IN}$	Input Current	at Pins 9, 10, 11 at $0V < V_{IN} < 5V$	1.0	$\pm 100$	nA (max)	
$f_{CLK}$	Clock Frequency		3	2	MHz (max)	
$V_{IH}$	High-Level Input Voltage	at Pins 9, 10, 11		2.0	V (min)	
$V_{IL}$	Low-Level Input Voltage Data-Out Levels (Pin 12)	$V_{DD} = 6V$ , $V_{SS} = 0V$		0.8	V (max)	
				0.1	V (max)	
				5.9	V (min)	

- (1) *Absolute Maximum Ratings* indicate limits beyond which damage to the device may occur. *Operating Ratings* indicate conditions for which the device is functional, but do not guarantee specific performance limits. *Electrical Characteristics* state DC and AC electrical specifications under particular test conditions which guarantee specific performance limits. This assumes that the device is within the Operating Ratings. Specifications are not guaranteed for parameters where no limit is given, however, the typical value is a good indication of device performance.
- (2) All voltages are measured with respect to GND (pins 1, 3, 5, 14, 17), unless otherwise specified.
- (3) Typicals are measured at  $25^\circ C$  and represent the parametric norm.
- (4) Limits are guaranteed to TI's AOQL (Average Output Quality Level).
- (5) At the present time the Crosstalk measurement is specified as a typical only, which is due to a hardware limitation of the automated test equipment.

### TEST CIRCUIT DIAGRAMS

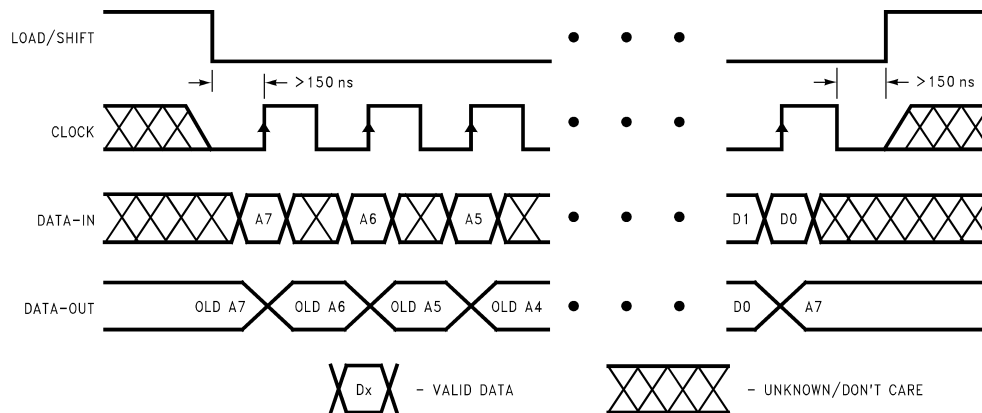

**Figure 3. Timing Diagram**

### PIN DESCRIPTIONS

**Signal Ground (1, 5, 17):** Each input has its own independent ground, GND1, GND2, and GND3.

**Signal Input (2, 4, 18):** There are 3 independent signal inputs, IN1, IN2, and IN3.

**Signal Output (6, 16, 20):** There are 3 independent signal outputs, OUT1, OUT2, and OUT3.

**Voltage Supply (13, 15):**

**Voltage Supply (7, 19):** Negative voltage supply pins,  $V_{SS1}$  and  $V_{SS2}$ . To be tied to ground in a single supply configuration.

**AC Ground (3, 14):** These two pins are not physically connected to the die in any way (i.e., No bondwires). These pins must be AC grounded to prevent signal coupling between any of the pins nearby. Pin 14 should be connected to pins 13 and 15 for ease of wiring and the best isolation.

**Logic Ground (8):** Digital signal ground for the interface lines; CLOCK, LOAD/SHIFT, DATA-IN and DATA-OUT.

**Clock (9):** The clock input accepts a TTL or CMOS level signal. The clock input is used to load data into the internal shift register on the rising edge of the input clock waveform.

**Load/Shift (10):** The load/shift input accepts a TTL or CMOS level signal. This is the enable pin of the device, allowing data to be clocked in while this input is low (0V).

**Data-In (11):** The data-in input accepts a TTL or CMOS level signal. This pin is used to accept serial data from a microcontroller that will be latched and decoded to change a channel's attenuation level.

**Data-Out (12):** This pin is used in daisy-chain mode where more than one  $\mu$ Pot is controlled via the same data line. As the data is clocked into the chain from the  $\mu$ C, the preceding data in the shift register is shifted out the DATA-OUT pin to the next  $\mu$ Pot in the chain or to ground if it is the last  $\mu$ Pot in the chain. The LOAD/SHIFT line goes high once all of the new data has been shifted into each of its respective registers.

TYPICAL PERFORMANCE CHARACTERISTICS

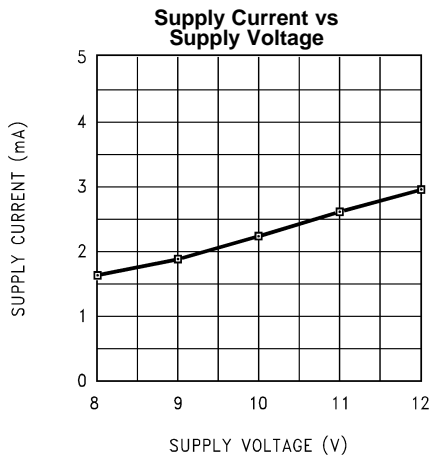

Figure 4.

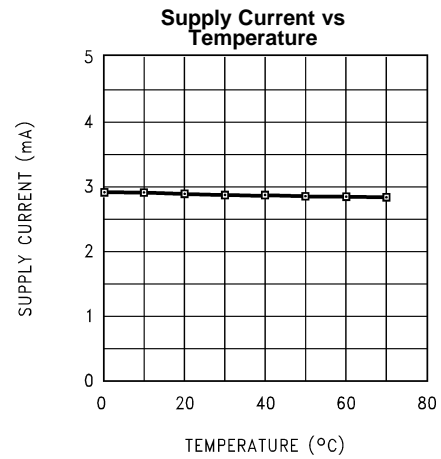

Figure 5.

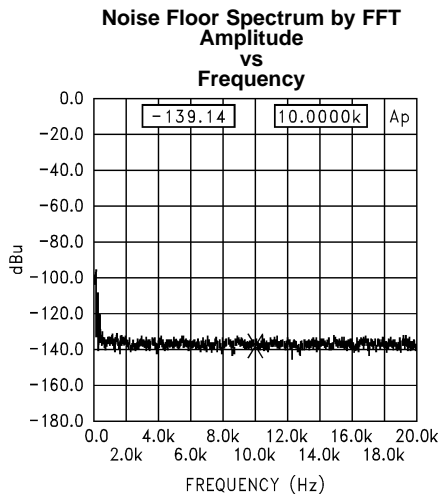

Figure 6.

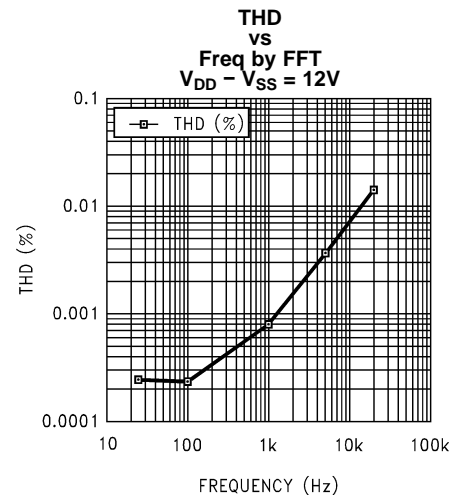

Figure 7.

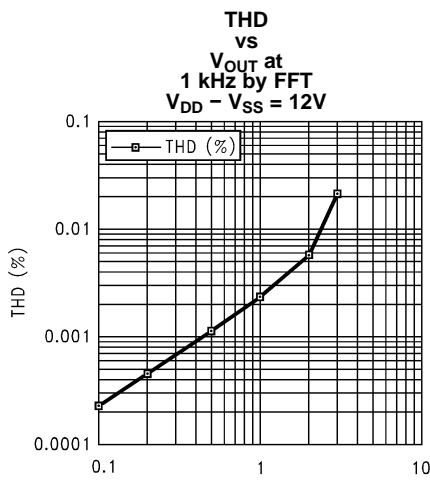

Figure 8.

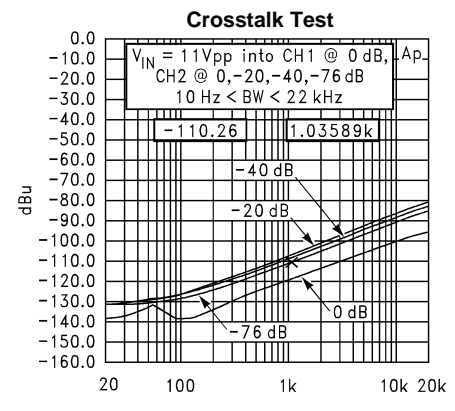

Figure 9.

**TYPICAL PERFORMANCE CHARACTERISTICS (continued)**

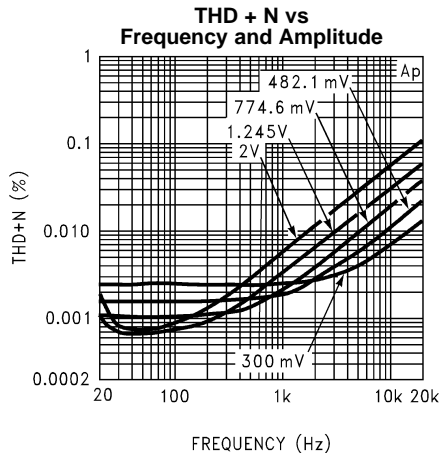

Figure 10.

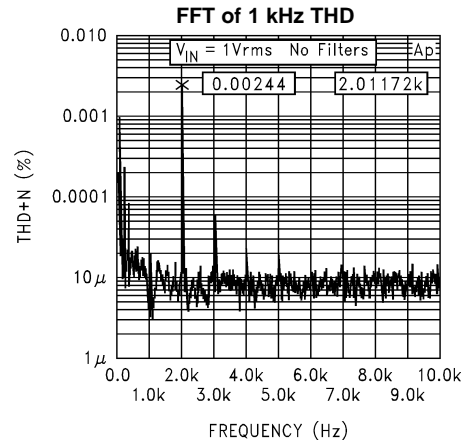

Figure 11.

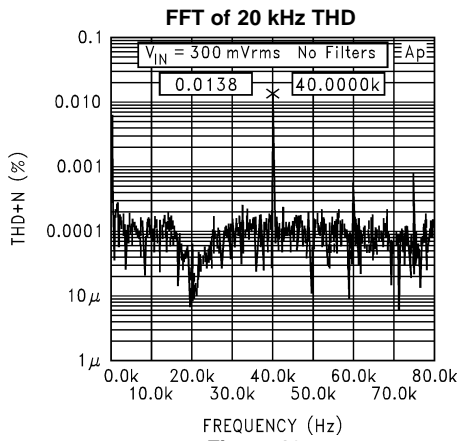

Figure 12.

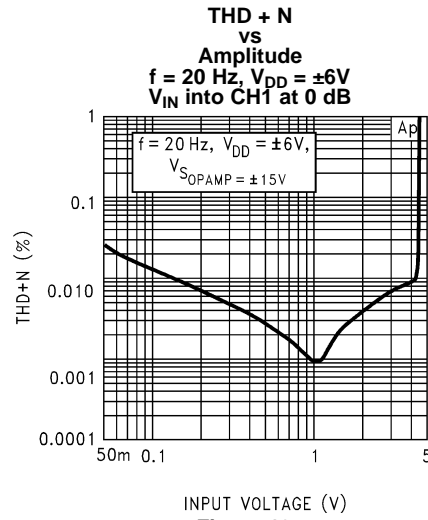

Figure 13.

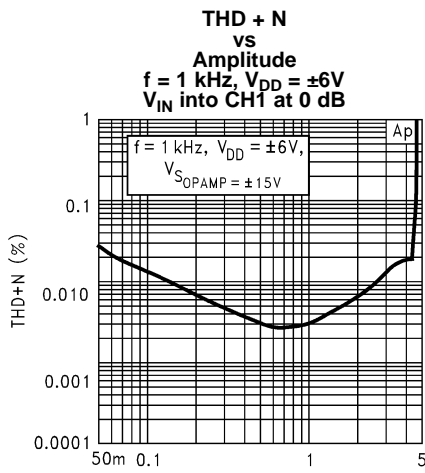

Figure 14.

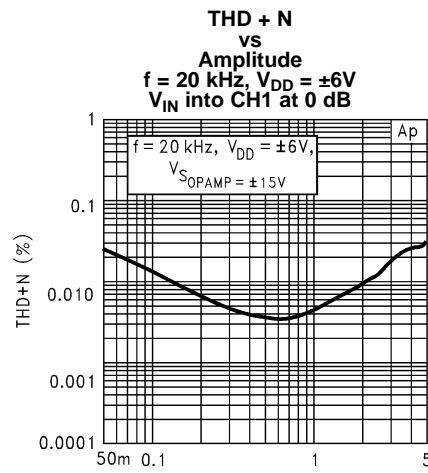

Figure 15.

## APPLICATION INFORMATION

### ATTENUATION STEP SCHEME

The fundamental attenuation step scheme for the LM1973  $\mu$ Pot is shown in Figure 16. This attenuation step scheme, however, can be changed through programming techniques to fit different application requirements. One such example would be a constant logarithmic attenuation scheme of 2dB steps for a panning function as shown in Figure 18. The only restriction to the customization of attenuation schemes are the given attenuation levels and their corresponding data bits shown in Table 1. The device will change attenuation levels only when a channel address is recognized. When recognized, the attenuation level will be changed corresponding to the data bits shown in Table 1. As shown in Figure 19, an LM1973 can be configured with a mono audio signal level control and with a panning control which separates the mono signal into left and right channels. This circuit may utilize the fundamental attenuation scheme of the LM1973 for the level control, but also possess a constant 2dB panning control for the left and right channels as stated earlier.

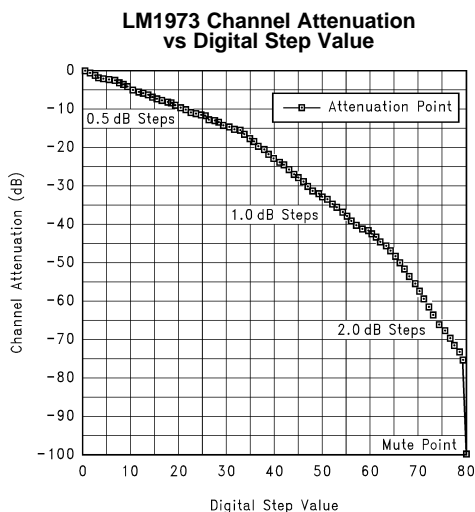

Figure 16.

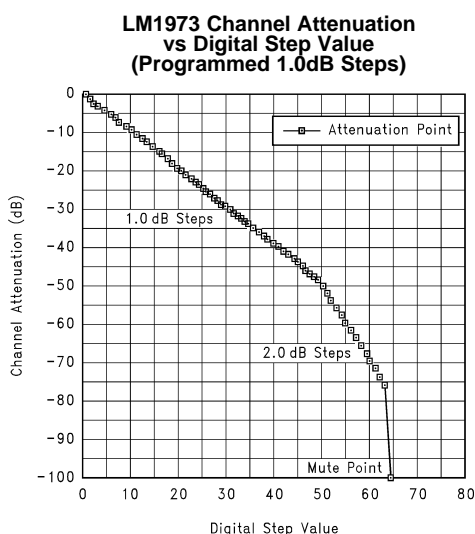
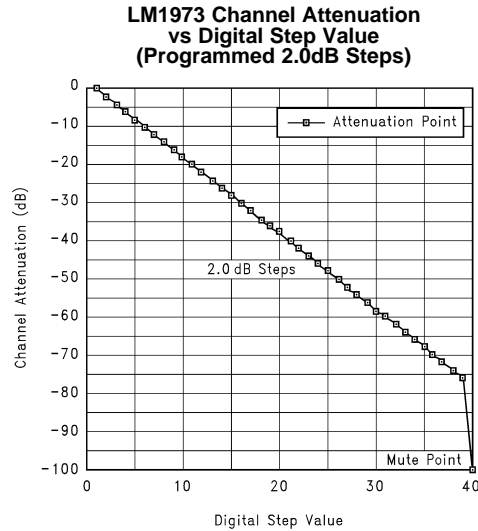
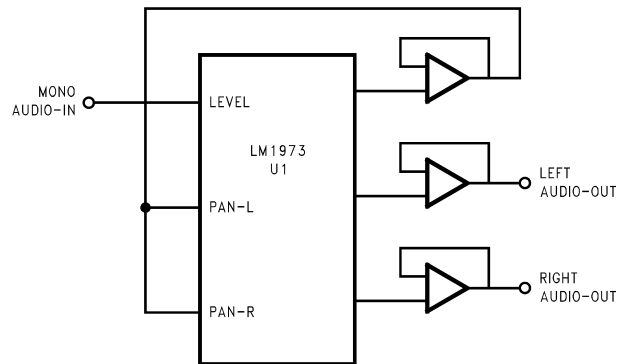

Figure 17. LM1973 1.0dB and 2.0dB Attenuation Step Scheme



**Figure 18. LM1973 2.0dB Attenuation Step Scheme**



**Figure 19. Mono Level Control with Panning Circuit**

## INPUT IMPEDANCE

The input impedance of a  $\mu$ Pot is constant at a nominal 40 k $\Omega$ . To eliminate any unwanted DC components from propagating through the device it is common to use 1  $\mu$ F input coupling caps. This is not necessary, however, if the dc offset from the previous stage is negligible. For higher performance systems, input coupling caps are preferred.

## OUTPUT IMPEDANCE

The output of a  $\mu$ Pot varies typically between 25 k $\Omega$  and 35 k $\Omega$  and changes nonlinearly with step changes. Since a  $\mu$ Pot is made up of a resistor ladder network with a logarithmic attenuation, the output impedance is nonlinear. Due to this configuration, a  $\mu$ Pot cannot be considered as a linear potentiometer, but can be considered only as a logarithmic attenuator.

It should be noted that the linearity of a  $\mu$ Pot cannot be measured directly without a buffer because the input impedance of most measurement systems is not high enough to provide the required accuracy. Due to the low impedance of the measurement system, the output of the  $\mu$ Pot would be loaded down and an incorrect reading will result. To prevent loading from occurring, a JFET input op amp should be used as the buffer/amplifier. The performance of a  $\mu$ Pot is limited only by the performance of the external buffer/amplifier.

## MUTE FUNCTION

One major feature of a  $\mu$ Pot is its ability to mute the input signal to an attenuation level of 104dB as shown in [Figure 16](#). This is accomplished internally by physically isolating the output from the input while also grounding the output pin through approximately 2 k $\Omega$ .



The mute function is obtained during power-up of the device or by sending any binary data of 01001111 and above (to 11111111) serially to the device. The device may be placed into mute from a previous attenuation setting by sending any of the above data. This allows the designer to place a mute button onto his system which could cause a microcontroller to send the appropriate data to a  $\mu$ Pot and thus mute any or all channels. Since this function is achieved through software, the designer has a great amount of flexibility in configuring the system.

## DC INPUTS

Although the  $\mu$ Pot was designed to be used as an attenuator for signals within the audio spectrum, the device is capable of tracking an input DC voltage. The device will track DC voltages to a diode drop above each supply rail.

One point to remember about DC tracking is that with a buffer at the output of the  $\mu$ Pot, the resolution of DC tracking will depend upon the gain configuration of that output buffer and its supply voltage. It should also be remembered that the output buffer's supply voltage does not have to be the same as the  $\mu$ Pot's supply voltage. This could allow for more resolution when DC tracking.

## SERIAL DATA FORMAT

The LM1973 uses a 3-wire serial communication format that is easily controlled by a microcontroller. The timing for the 3-wire set, comprised of DATA-IN, CLOCK, and LOAD/SHIFT is shown in Figure 3. Figure 22 exhibits in block diagram form how the digital interface controls the tap switches which select the appropriate attenuation level. As depicted in Figure 3, the LOAD/SHIFT line is to go low at least 150 ns before the rising edge of the first clock pulse and is to remain low throughout the transmission of each set of 16 data bits. The serial data is comprised of 8 bits for channel selection and 8 bits for attenuation setting. For both address data and attenuation setting data, the MSB is sent first and the 8 bits of address data are to be sent before the 8 bits of attenuation data. Please refer to Figure 20 to confirm the serial data format transfer process.

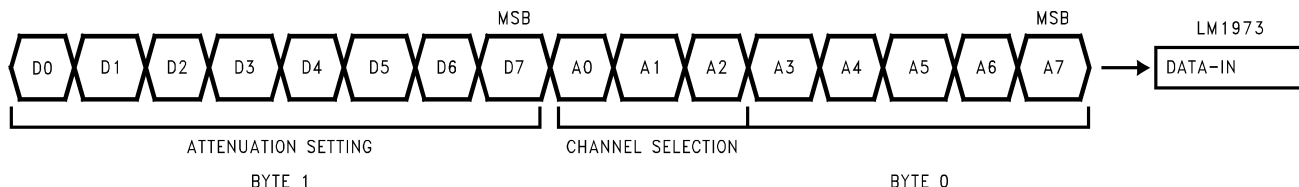

Figure 20. Serial Data Format Transfer Process

Table 1. LM1973 Micropot Attenuator Register Set Description

MSB: LSB	
<b>Address Register (Byte 0)</b>	
0000 0000	Channel 1
0000 0001	Channel 2
0000 0010	Channel 3
<b>Data Register (Byte 1)</b>	
<b>Contents</b>	<b>Attenuation Level dB</b>
0000 0000	0.0
0000 0001	0.5
0000 0010	1.0
0000 0011	1.5
.....	::
0001 1110	15.0
0001 1111	15.5
0010 0000	16.0
0010 0001	17.0
0010 0010	18.0

**Table 1. LM1973 Micropot Attenuator  
Register Set Description (continued)**

MSB: LSB	
Address Register (Byte 0)	
.....	::
0011 1110	46.0
0011 1111	47.0
0100 0000	48.0
0100 0001	50.0
0100 0010	52.0
.....	::
0100 1100	72.0
0100 1101	74.0
0100 1110	76.0
0100 1111	100.0 (Mute)
0101 0000	100.0 (Mute)
.....	::
1111 1110	100.0 (Mute)
1111 1111	100.0 (Mute)

## μPot SYSTEM ARCHITECTURE

The μPot's digital interface is essentially a shift register, where serial data is shifted in, latched, and then decoded. As new data is shifted into the DATA-IN pin, the previously latched data is shifted out the DATA-OUT pin. Once the data is shifted in, the LOAD/SHIFT line goes high, latching in the new data. The data is then decoded and the appropriate switch is activated to set the desired attenuation level for the selected channel. This process is continued each and every time an attenuation change is made. Each channel is updated, only, when that channel is selected for an attenuator change or the system is powered down and then back up again. When the μPot is powered up, each channel is placed into the muted mode.

## μPot LADDER ARCHITECTURE

Each channel of a μPot has its own independent resistor ladder network. As shown in [Figure 21](#), the ladder consists of multiple R1/R2 elements which make up the attenuation scheme. Within each element there are tap switches that select the appropriate attenuation level corresponding to the data bits in [Table 1](#). It can be seen in [Figure 21](#) that the input impedance for the channel is a constant value regardless of which tap switch is selected, while the output impedance varies according to the tap switch selected.

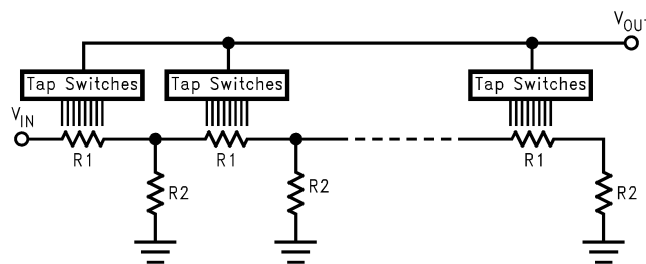
**Figure 21. μPot Ladder Architecture**

## DIGITAL LINE COMPATIBILITY

The μPot's digital interface section is compatible with either TTL or CMOS logic due to the shift register inputs acting upon a threshold voltage of 2 diode drops or approximately 1.4V.

## DIGITAL DATA-OUT PIN

The DATA-OUT pin is available for daisy-chain system configurations where multiple  $\mu$ Pots will be used. The use of the daisy-chain configuration allows the system designer to use only one DATA and one LOAD/SHIFT line per chain, thus simplifying PCB trace layouts.

In order to provide the highest level of channel separation and isolate any of the signal lines from digital noise, the DATA-OUT pin should be terminated through a 2 k $\Omega$  resistor if not used. The pin may be left floating, however, any signal noise on that line may couple to adjacent lines creating higher noise specs.

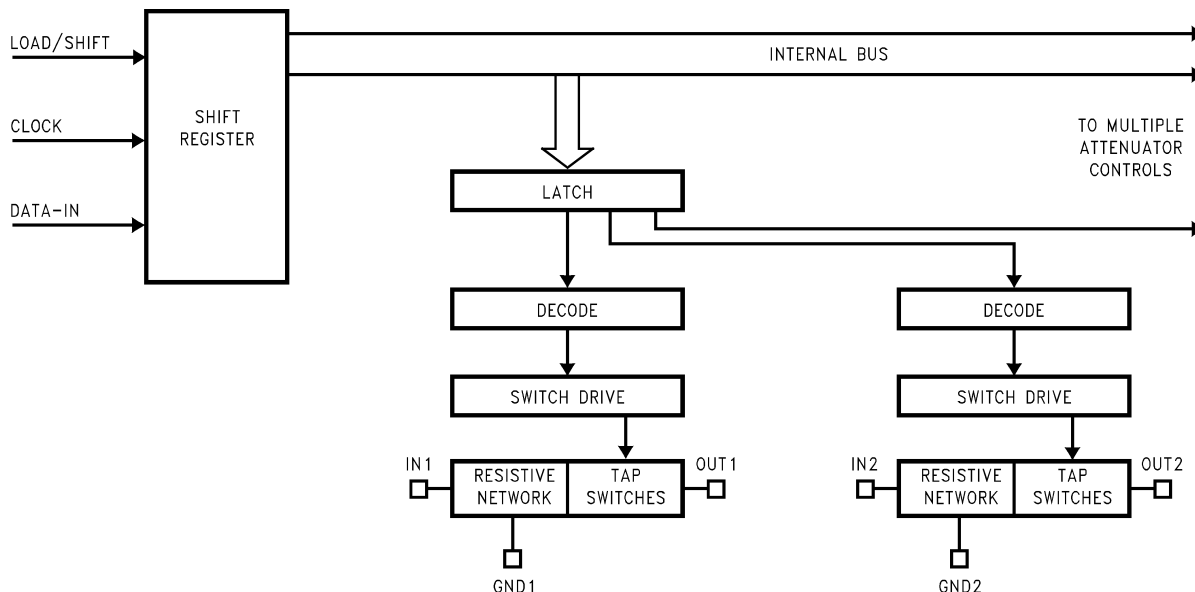

Figure 22.  $\mu$ Pot System Architecture

## DAISY-CHAIN CAPABILITY

Since the  $\mu$ Pot's digital interface is essentially a shift register, multiple  $\mu$ Pots can be programmed utilizing the same data and load/shift lines. As shown in Figure 24, for an n- $\mu$ Pot daisy-chain, there are 16n bits to be shifted and loaded for the chain. The data loading sequence is the same for n- $\mu$ Pots as it is for one  $\mu$ Pot. First the LOAD/SHIFT line goes low, then the data is clocked in sequentially while the preceding data in each  $\mu$ Pot is shifted out the DATA-OUT pin to the next  $\mu$ Pot in the chain or to ground if it is the last  $\mu$ Pot in the chain. Then the LOAD/SHIFT line goes high; latching the data into each of their corresponding  $\mu$ Pots. The data is then decoded according to the address (channel selection) and the appropriate tap switch controlling the attenuation level is selected.

## CROSSTALK MEASUREMENTS

The crosstalk of a  $\mu$ Pot as shown in Figure 9 in the TYPICAL PERFORMANCE CHARACTERISTICS was obtained by placing a signal on one channel and measuring the level at the output of another channel of the same frequency. It is important to be sure that the signal level being measured is of the same frequency such that a true indication of crosstalk may be obtained. Also, to ensure an accurate measurement, the measured channel's input should be AC grounded through a 1  $\mu$ F capacitor.

## CLICKS AND POPS

So, why is that output buffer needed anyway? There are three answers to this question, all of which are important from a system point of view.

1. The first reason to utilize a buffer/amplifier at the output of a  $\mu$ Pot is to ensure that there are no audible clicks or pops due to attenuation step changes in the device. If an on-board bipolar op amp had been used for the output stage, its requirement of a finite amount of DC bias current for operation would cause a DC voltage "pop" when the output impedance of the  $\mu$ Pot changes. Again, this phenomenon is due to the fact that the output impedance of the  $\mu$ Pot is changing with step changes and a bipolar amplifier requires a finite amount

of DC bias current for its operation. As the impedance changes, so does the DC bias current and thus there is a DC voltage “pop”.

2. Secondly, the  $\mu$ Pot has no drive capability, so any desired gain needs to be accomplished through a buffer/non-inverting amplifier.
3. Third, the output of a  $\mu$ Pot needs to see a high impedance to prevent loading and subsequent linearity errors from occurring. A JFET input buffer provides a high input impedance to the output of the  $\mu$ Pot so that this does not occur.

Clicks and pops can be avoided by using a JFET input buffer/amplifier such as an LF412ACN. The LF412 has a high input impedance and exhibits both a low noise floor and low THD+N throughout the audio spectrum which maintains signal integrity and linearity for the system. The performance of the system solution is entirely dependent upon the quality and performance of the JFET input buffer/amplifier.

## LOGARITHMIC GAIN AMPLIFIER

The  $\mu$ Pot is capable of being used in the feedback loop of an amplifier, however, as stated previously, the output of the  $\mu$ Pot needs to see a high impedance in order to maintain its high performance and linearity. Again, loading the output will change the values of attenuation for the device. As shown in Figure 23, a  $\mu$ Pot used in the feedback loop creates a logarithmic gain amplifier. In this configuration the attenuation levels from Table 1, now become gain levels with the largest possible gain value being 76dB. For most applications 76dB of gain will cause signal clipping to occur, however, because of the  $\mu$ Pot's versatility the gain can be controlled through programming such that the clipping level of the system is never obtained. An important point to remember is that when in mute mode the input is disconnected from the output. In this configuration this will place the amplifier in its open loop gain state, thus resulting in severe comparator action. Care should be taken with the programming and design of this type of circuit. To provide the best performance, a JFET input amplifier should be used.

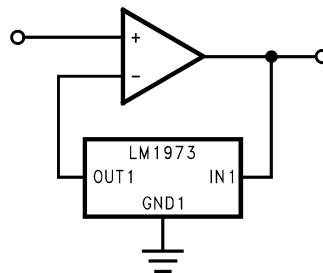

Figure 23. Digitally-Controlled Logarithmic Gain Amplifier Circuit

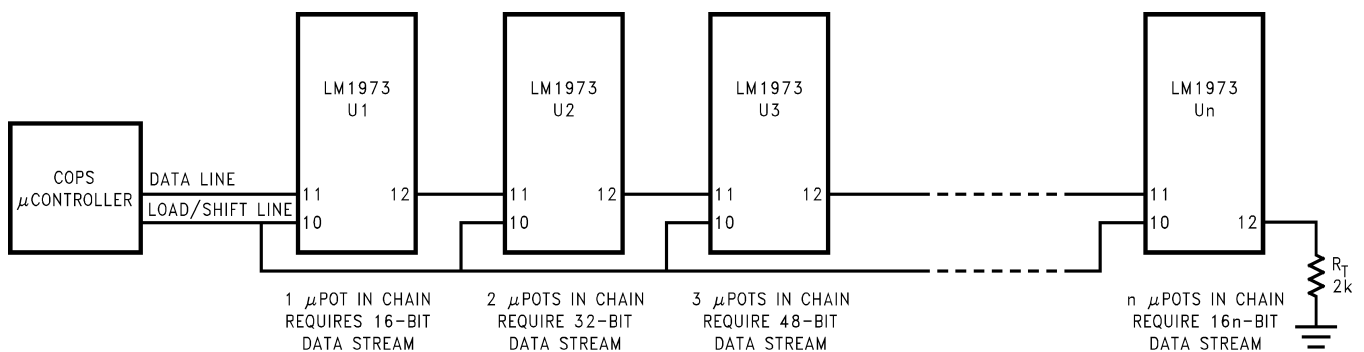



Figure 24. n- $\mu$ Pot Daisy-Chain Circuit

**PACKAGING INFORMATION**

Orderable Device	Status (1)	Package Type	Package Drawing	Pins	Package Qty	Eco Plan (2)	Lead/Ball Finish	MSL Peak Temp (3)	Op Temp (°C)	Top-Side Markings (4)	Samples
LM1973M/NOPB	ACTIVE	SOIC	DW	20	36	Green (RoHS & no Sb/Br)	CU SN	Level-3-260C-168 HR	0 to 70	LM1973M	
LM1973MX/NOPB	ACTIVE	SOIC	DW	20	1000	Green (RoHS & no Sb/Br)	CU SN	Level-3-260C-168 HR	0 to 70	LM1973M	

(1) The marketing status values are defined as follows:

**ACTIVE:** Product device recommended for new designs.

**LIFEBUY:** TI has announced that the device will be discontinued, and a lifetime-buy period is in effect.

**NRND:** Not recommended for new designs. Device is in production to support existing customers, but TI does not recommend using this part in a new design.

**PREVIEW:** Device has been announced but is not in production. Samples may or may not be available.

**OBSOLETE:** TI has discontinued the production of the device.

(2) Eco Plan - The planned eco-friendly classification: Pb-Free (RoHS), Pb-Free (RoHS Exempt), or Green (RoHS & no Sb/Br) - please check <http://www.ti.com/productcontent> for the latest availability information and additional product content details.

**TBD:** The Pb-Free/Green conversion plan has not been defined.

**Pb-Free (RoHS):** TI's terms "Lead-Free" or "Pb-Free" mean semiconductor products that are compatible with the current RoHS requirements for all 6 substances, including the requirement that lead not exceed 0.1% by weight in homogeneous materials. Where designed to be soldered at high temperatures, TI Pb-Free products are suitable for use in specified lead-free processes.

**Pb-Free (RoHS Exempt):** This component has a RoHS exemption for either 1) lead-based flip-chip solder bumps used between the die and package, or 2) lead-based die adhesive used between the die and leadframe. The component is otherwise considered Pb-Free (RoHS compatible) as defined above.

**Green (RoHS & no Sb/Br):** TI defines "Green" to mean Pb-Free (RoHS compatible), and free of Bromine (Br) and Antimony (Sb) based flame retardants (Br or Sb do not exceed 0.1% by weight in homogeneous material)

(3) MSL, Peak Temp. -- The Moisture Sensitivity Level rating according to the JEDEC industry standard classifications, and peak solder temperature.

(4) Only one of markings shown within the brackets will appear on the physical device.

**Important Information and Disclaimer:** The information provided on this page represents TI's knowledge and belief as of the date that it is provided. TI bases its knowledge and belief on information provided by third parties, and makes no representation or warranty as to the accuracy of such information. Efforts are underway to better integrate information from third parties. TI has taken and continues to take reasonable steps to provide representative and accurate information but may not have conducted destructive testing or chemical analysis on incoming materials and chemicals. TI and TI suppliers consider certain information to be proprietary, and thus CAS numbers and other limited information may not be available for release.

In no event shall TI's liability arising out of such information exceed the total purchase price of the TI part(s) at issue in this document sold by TI to Customer on an annual basis.

DW (R-PDSO-G20)

PLASTIC SMALL OUTLINE



- NOTES:
- A. All linear dimensions are in inches (millimeters). Dimensioning and tolerancing per ASME Y14.5M-1994.
  - B. This drawing is subject to change without notice.
  - C. Body dimensions do not include mold flash or protrusion not to exceed 0.006 (0,15).
  - D. Falls within JEDEC MS-013 variation AC.

## IMPORTANT NOTICE

Texas Instruments Incorporated and its subsidiaries (TI) reserve the right to make corrections, enhancements, improvements and other changes to its semiconductor products and services per JESD46, latest issue, and to discontinue any product or service per JESD48, latest issue. Buyers should obtain the latest relevant information before placing orders and should verify that such information is current and complete. All semiconductor products (also referred to herein as "components") are sold subject to TI's terms and conditions of sale supplied at the time of order acknowledgment.

TI warrants performance of its components to the specifications applicable at the time of sale, in accordance with the warranty in TI's terms and conditions of sale of semiconductor products. Testing and other quality control techniques are used to the extent TI deems necessary to support this warranty. Except where mandated by applicable law, testing of all parameters of each component is not necessarily performed.

TI assumes no liability for applications assistance or the design of Buyers' products. Buyers are responsible for their products and applications using TI components. To minimize the risks associated with Buyers' products and applications, Buyers should provide adequate design and operating safeguards.

TI does not warrant or represent that any license, either express or implied, is granted under any patent right, copyright, mask work right, or other intellectual property right relating to any combination, machine, or process in which TI components or services are used. Information published by TI regarding third-party products or services does not constitute a license to use such products or services or a warranty or endorsement thereof. Use of such information may require a license from a third party under the patents or other intellectual property of the third party, or a license from TI under the patents or other intellectual property of TI.

Reproduction of significant portions of TI information in TI data books or data sheets is permissible only if reproduction is without alteration and is accompanied by all associated warranties, conditions, limitations, and notices. TI is not responsible or liable for such altered documentation. Information of third parties may be subject to additional restrictions.

Resale of TI components or services with statements different from or beyond the parameters stated by TI for that component or service voids all express and any implied warranties for the associated TI component or service and is an unfair and deceptive business practice. TI is not responsible or liable for any such statements.

Buyer acknowledges and agrees that it is solely responsible for compliance with all legal, regulatory and safety-related requirements concerning its products, and any use of TI components in its applications, notwithstanding any applications-related information or support that may be provided by TI. Buyer represents and agrees that it has all the necessary expertise to create and implement safeguards which anticipate dangerous consequences of failures, monitor failures and their consequences, lessen the likelihood of failures that might cause harm and take appropriate remedial actions. Buyer will fully indemnify TI and its representatives against any damages arising out of the use of any TI components in safety-critical applications.

In some cases, TI components may be promoted specifically to facilitate safety-related applications. With such components, TI's goal is to help enable customers to design and create their own end-product solutions that meet applicable functional safety standards and requirements. Nonetheless, such components are subject to these terms.

No TI components are authorized for use in FDA Class III (or similar life-critical medical equipment) unless authorized officers of the parties have executed a special agreement specifically governing such use.

Only those TI components which TI has specifically designated as military grade or "enhanced plastic" are designed and intended for use in military/aerospace applications or environments. Buyer acknowledges and agrees that any military or aerospace use of TI components which have **not** been so designated is solely at the Buyer's risk, and that Buyer is solely responsible for compliance with all legal and regulatory requirements in connection with such use.

TI has specifically designated certain components as meeting ISO/TS16949 requirements, mainly for automotive use. In any case of use of non-designated products, TI will not be responsible for any failure to meet ISO/TS16949.

### Products

Audio	<a href="http://www.ti.com/audio">www.ti.com/audio</a>
Amplifiers	<a href="http://amplifier.ti.com">amplifier.ti.com</a>
Data Converters	<a href="http://dataconverter.ti.com">dataconverter.ti.com</a>
DLP® Products	<a href="http://www.dlp.com">www.dlp.com</a>
DSP	<a href="http://dsp.ti.com">dsp.ti.com</a>
Clocks and Timers	<a href="http://www.ti.com/clocks">www.ti.com/clocks</a>
Interface	<a href="http://interface.ti.com">interface.ti.com</a>
Logic	<a href="http://logic.ti.com">logic.ti.com</a>
Power Mgmt	<a href="http://power.ti.com">power.ti.com</a>
Microcontrollers	<a href="http://microcontroller.ti.com">microcontroller.ti.com</a>
RFID	<a href="http://www.ti-rfid.com">www.ti-rfid.com</a>
OMAP Applications Processors	<a href="http://www.ti.com/omap">www.ti.com/omap</a>
Wireless Connectivity	<a href="http://www.ti.com/wirelessconnectivity">www.ti.com/wirelessconnectivity</a>

### Applications

Automotive and Transportation	<a href="http://www.ti.com/automotive">www.ti.com/automotive</a>
Communications and Telecom	<a href="http://www.ti.com/communications">www.ti.com/communications</a>
Computers and Peripherals	<a href="http://www.ti.com/computers">www.ti.com/computers</a>
Consumer Electronics	<a href="http://www.ti.com/consumer-apps">www.ti.com/consumer-apps</a>
Energy and Lighting	<a href="http://www.ti.com/energy">www.ti.com/energy</a>
Industrial	<a href="http://www.ti.com/industrial">www.ti.com/industrial</a>
Medical	<a href="http://www.ti.com/medical">www.ti.com/medical</a>
Security	<a href="http://www.ti.com/security">www.ti.com/security</a>
Space, Avionics and Defense	<a href="http://www.ti.com/space-avionics-defense">www.ti.com/space-avionics-defense</a>
Video and Imaging	<a href="http://www.ti.com/video">www.ti.com/video</a>

### TI E2E Community

[e2e.ti.com](http://e2e.ti.com)