

THOMSON SEMICONDUCTORS

LM108,A
LM208,A
LM308,A

PRECISION SINGLE OP-AMPS

The LM108,A is a precision operational amplifier having specifications a factor ten better than FET amplifiers over a -55°C to $+125^{\circ}\text{C}$ temperature range. Selected units are available with offset voltages less than 1 mV and drifts less than $5\mu\text{V}/^{\circ}\text{C}$. This makes it possible to eliminate offset adjustments, in most cases.

The device operates with supply voltages from $\pm 2\text{ V}$ to $\pm 20\text{ V}$ (LM308 : $\pm 2\text{ V}$ to $\pm 15\text{ V}$) and has sufficient supply rejection to use unregulated supplies. Although the circuit is interchangeable with and uses the same compensation as the LM101A, an alternate compensation scheme can be used to make it particularly insensitive to power supply noise and to make supply bypass capacitors unnecessary.

Outstanding characteristics of LM108A :

- Input offset voltage : 0.5 mV maximum
- Input bias current : 3 nA maximum over full temperature range
- Input offset current : 0.4 nA maximum over full temperature range
- Power supply current : 600 μA maximum
- Guaranteed drift characteristics
- Slew rate of 10 V/ μs as inverting amplifier.

ORDERING INFORMATION

Hi-Rel versions available - See chapter 14

PART NUMBER	TEMPERATURE RANGE	PACKAGE				
		H	DG	DP	GC	FP
LM108,A	-55°C to $+125^{\circ}\text{C}$	•	•		•	
LM208,A	-25°C to $+85^{\circ}\text{C}$	•				
LM308,A	0°C to $+70^{\circ}\text{C}$	•	•	•		•

Examples : LM108H, LM108AH, LM308DG

PRECISION SINGLE OPERATIONAL AMPLIFIERS

CASES

CB-11
(TO-99)



H SUFFIX
METAL CAN

CB-705



GC SUFFIX
TRICECOP (LCC)

CB-98



DP SUFFIX
PLASTIC PACKAGE

DG SUFFIX
CERDIP PACKAGE

CB-342



FP SUFFIX
PLASTIC
MICROPACKAGE

PIN ASSIGNMENTS

(Top views)

CB-11

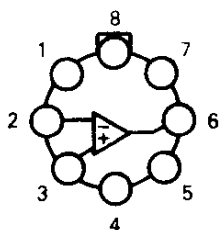

- 1 - Frequency compensation
- 2 - Inverting input
- 3 - Non-inverting input
- 4 - V_{CC}^-

CB-98
CB-342

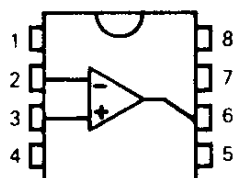

- 5 - NC
- 6 - Output
- 7 - V_{CC}^+
- 8 - Frequency compensation

- 1 - NC
- 2 - Frequency compensation
- 3 - NC
- 4 - NC
- 5 - Inverting input
- 6 - NC
- 7 - Non-inverting input
- 8 - NC
- 9 - NC
- 10 - V_{CC}^-

CB-705

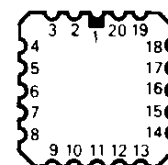

- 11 - NC
- 12 - NC
- 13 - NC
- 14 - NC
- 15 - Output
- 16 - NC
- 17 - V_{CC}^+
- 18 - NC
- 19 - NC
- 20 - Frequency compensation

THOMSON SEMICONDUCTORS

Sales headquarters
45, av. de l'Europe - 78120 VELIZY - FRANCE
Tel. : (3) 946 97 19 / Telex : 204780 F

MAXIMUM RATINGS

Rating	Symbol	LM108,A	LM208,A	LM308,A	Unit
Supply voltage	V _{CC}	± 20	± 20	± 18	V
Input voltage (Note 2)	V _I	± 15	± 15	± 15	V
Input offset current (Note 1)	I _{IO}	± 10	± 10	± 10	mA
Power dissipation LM108GC, LM108AGC	P _{tot}	500 665	500 —	500 —	mW
Output short-circuit duration	—	Indefinite	Indefinite	Indefinite	—
Operating free-air temperature range	T _{oper}	- 55 to + 125	- 25 to + 85	0 to + 70	°C
Storage temperature range	T _{stg}	- 65 to + 150	- 65 to + 150	- 55 to + 125	°C

Note 1 : The inputs are shunted with back-to-back diodes for overvoltage protection. Therefore, excessive current will flow if a differential input voltage in excess of 1 V is applied between the inputs unless some limiting resistance is used.

Note 2 : For supply voltages less than ± 15 V, the absolute maximum input voltage is equal to the supply voltage.

SCHEMATIC DIAGRAM

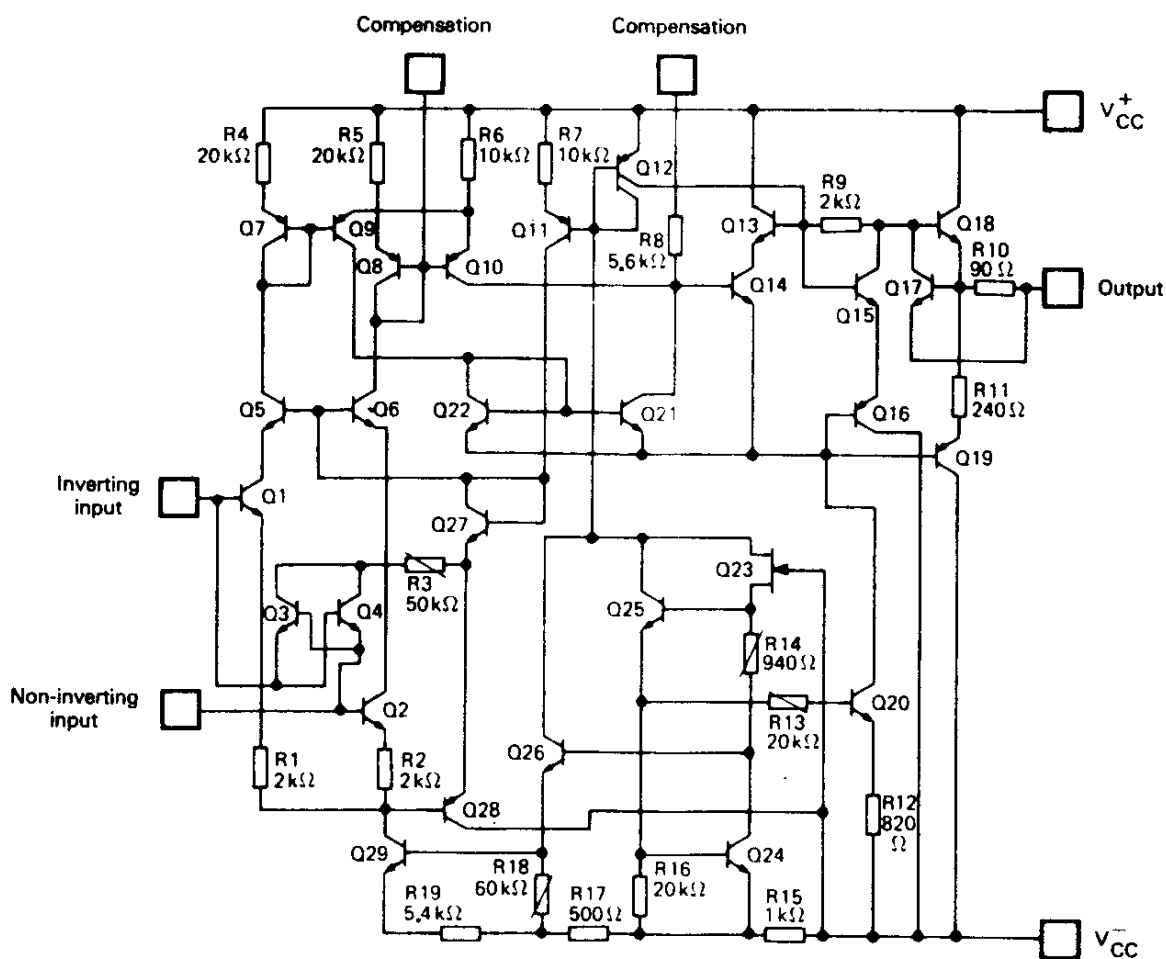

CASE	Frequency Compens.	Inverting input	Non-inverting input	V _{CC}	V _{CC}	Output	N.C.
CB-11 CB-98 CB-342	1, 8	2	3	4	7	6	5
CB-705	2, 20	5	7	10	17	15	*

* CB705 : Other pins are not connected.

ELECTRICAL CHARACTERISTICS

LM108A : $-55^{\circ}\text{C} \leq T_{\text{amb}} \leq +125^{\circ}\text{C}$, $\pm 5 \text{ V} \leq V_{\text{CC}} \leq \pm 20 \text{ V}$ LM208A : $-25^{\circ}\text{C} \leq T_{\text{amb}} \leq +85^{\circ}\text{C}$, $\pm 5 \text{ V} \leq V_{\text{CC}} \leq \pm 20 \text{ V}$ LM308A : $0^{\circ}\text{C} \leq T_{\text{amb}} \leq +70^{\circ}\text{C}$, $\pm 5 \text{ V} \leq V_{\text{CC}} \leq \pm 15 \text{ V}$

(Unless otherwise specified)

Characteristic	Symbol	LM108A - LM208A			LM308A			Unit
		Min	Typ	Max	Min	Typ	Max	
Input offset voltage $T_{\text{amb}} = +25^{\circ}\text{C}$ $T_{\text{min}} \leq T_{\text{amb}} \leq T_{\text{max}}$	V_{IO}	—	0.3	0.5	—	0.3	0.5	mV
		—	—	1	—	—	0.73	
Input offset current $T_{\text{amb}} = +25^{\circ}\text{C}$ $T_{\text{min}} \leq T_{\text{amb}} \leq T_{\text{max}}$	I_{IO}	—	0.05	0.2	—	0.2	1	nA
		—	—	0.4	—	—	1.5	
Input bias current $T_{\text{amb}} = +25^{\circ}\text{C}$ $T_{\text{min}} \leq T_{\text{amb}} \leq T_{\text{max}}$	I_{IB}	—	0.8	2	—	1.5	7	nA
		—	—	3	—	—	10	
Large signal voltage gain ($V_{\text{CC}} = \pm 15 \text{ V}$, $R_{\text{L}} \geq 10 \text{ k}\Omega$, $V_{\text{O}} = \pm 10 \text{ V}$) $T_{\text{amb}} = +25^{\circ}\text{C}$ $T_{\text{min}} \leq T_{\text{amb}} \leq T_{\text{max}}$	A_{VD}	80	300	—	80	300	—	V/mV
		40	—	—	60	—	—	
Supply voltage rejection ratio	SVR	96	110	—	96	110	—	dB
Supply current $T_{\text{amb}} = +25^{\circ}\text{C}$ $T_{\text{amb}} = T_{\text{max}}$	$I_{\text{CC}}^{+}, I_{\text{CC}}^{-}$	—	0.3	0.6	—	0.3	0.8	mA
		—	0.15	0.4	—	—	—	
Temperature coefficient of input offset voltage	αV_{IO}	—	1	5	—	1	5	$\mu\text{V}/^{\circ}\text{C}$
Temperature coefficient of input offset current	αI_{IO}	—	0.5	2.5	—	2	10	$\text{pA}/^{\circ}\text{C}$
Input voltage range ($V_{\text{CC}} = \pm 15 \text{ V}$)	V_{I}	± 13.5	—	—	± 14	—	—	V
Common-mode rejection ratio	CMR	96	110	—	96	110	—	dB
Output voltage swing ($V_{\text{CC}} = \pm 15 \text{ V}$, $R_{\text{L}} = 10 \text{ k}\Omega$)	V_{OPP}	± 13	± 14	—	± 13	± 14	—	V
Input resistance ($T_{\text{amb}} = +25^{\circ}\text{C}$)	R_{I}	30	70	—	10	40	—	$\text{M}\Omega$

LM108 : $-55^{\circ}\text{C} \leq T_{\text{amb}} \leq +125^{\circ}\text{C}$, $\pm 5 \text{ V} \leq V_{\text{CC}} \leq \pm 20 \text{ V}$ LM208 : $-25^{\circ}\text{C} \leq T_{\text{amb}} \leq +85^{\circ}\text{C}$, $\pm 5 \text{ V} \leq V_{\text{CC}} \leq \pm 20 \text{ V}$ LM308 : $0^{\circ}\text{C} \leq T_{\text{amb}} \leq +70^{\circ}\text{C}$, $\pm 5 \text{ V} \leq V_{\text{CC}} \leq \pm 15 \text{ V}$

(Unless otherwise specified)

Characteristic	Symbol	LM108 - LM208			LM308			Unit
		Min	Typ	Max	Min	Typ	Max	
Input offset voltage $T_{\text{amb}} = +25^{\circ}\text{C}$ $T_{\text{min}} \leq T_{\text{amb}} \leq T_{\text{max}}$	V_{IO}	—	0.7	2	—	2	7.5	mV
		—	—	3	—	—	10	
Input offset current $T_{\text{amb}} = +25^{\circ}\text{C}$ $T_{\text{min}} \leq T_{\text{amb}} \leq T_{\text{max}}$	I_{IO}	—	0.05	0.2	—	0.2	1	nA
		—	—	0.4	—	—	1.5	
Input bias current $T_{\text{amb}} = +25^{\circ}\text{C}$ $T_{\text{min}} \leq T_{\text{amb}} \leq T_{\text{max}}$	I_{IB}	—	0.8	2	—	1.5	7	nA
		—	—	3	—	—	10	
Large signal voltage gain ($V_{\text{CC}} = \pm 15 \text{ V}$, $R_{\text{L}} \geq 10 \text{ k}\Omega$, $V_{\text{O}} = \pm 10 \text{ V}$) $T_{\text{amb}} = +25^{\circ}\text{C}$ $T_{\text{min}} \leq T_{\text{amb}} \leq T_{\text{max}}$	A_{VD}	50 25	300 —	— —	25 15	300 —	— —	V/mV
Supply voltage rejection ratio	SVR	80	96	—	80	96	—	dB
Supply current $T_{\text{amb}} = +25^{\circ}\text{C}$ $T_{\text{amb}} = T_{\text{max}}$	$I_{\text{CC}}^{+}, I_{\text{CC}}^{-}$	—	0.3 0.15	0.6 0.4	—	0.3 —	0.8 —	mA
Temperature coefficient of input offset voltage	αV_{IO}	—	3	15	—	6	30	$\mu\text{V}/^{\circ}\text{C}$
Temperature coefficient of input offset current	αI_{IO}	—	0.5	2.5	—	2	10	$\text{pA}/^{\circ}\text{C}$
Input voltage range ($V_{\text{CC}} = \pm 15 \text{ V}$)	V_{I}	± 13.5	—	—	± 14	—	—	V
Common-mode rejection ratio	CMR	85	100	—	80	100	—	dB
Output voltage swing ($V_{\text{CC}} = \pm 15 \text{ V}$, $R_{\text{L}} = 10 \text{ k}\Omega$)	V_{OPP}	± 13	± 14	—	± 13	± 14	—	V
Input resistance ($T_{\text{amb}} = +25^{\circ}\text{C}$)	R_{I}	30	70	—	10	40	—	M Ω

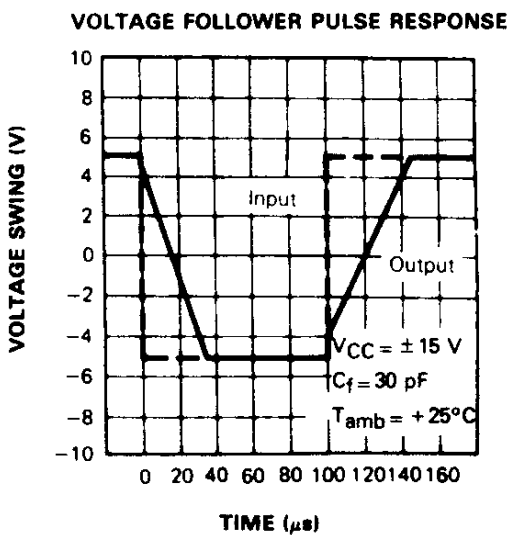
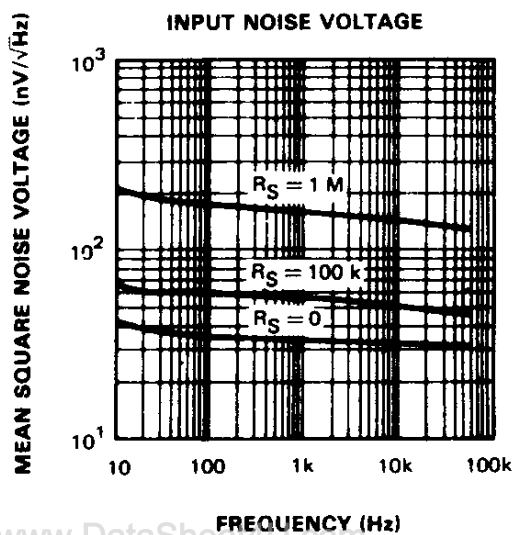
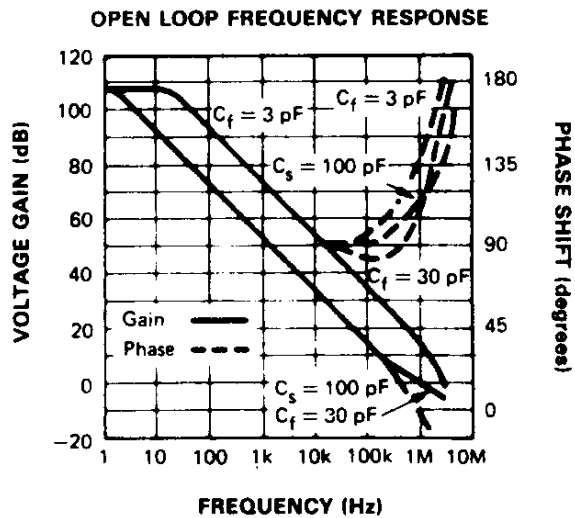
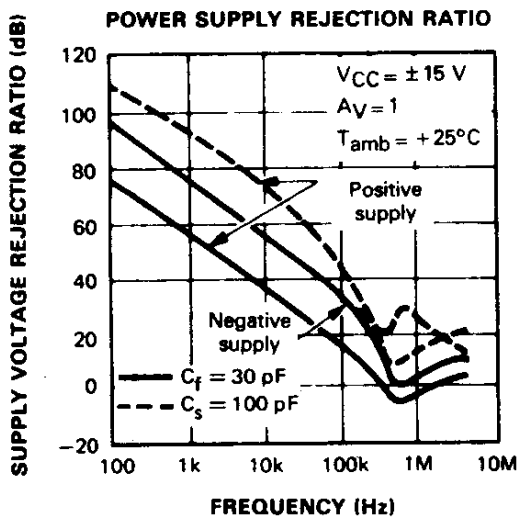
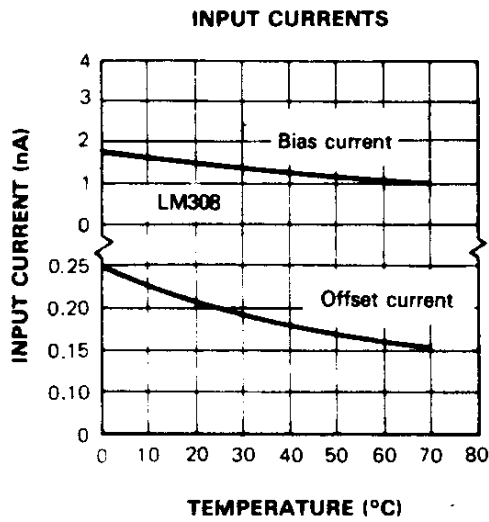
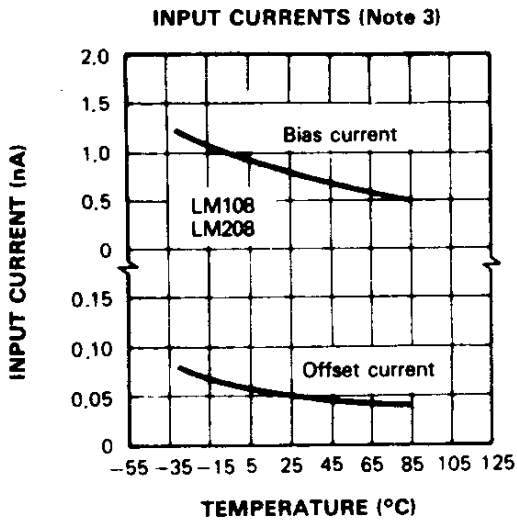

Note 3: LM108A: $-55^\circ\text{C} \leq T_{amb} \leq +125^\circ\text{C}$, $\pm 5\text{ V} \leq V_{CC} \leq \pm 20\text{ V}$.
LM208A: $-25^\circ\text{C} \leq T_{amb} \leq +85^\circ\text{C}$, $\pm 5\text{ V} \leq V_{CC} \leq \pm 20\text{ V}$.

LM108A

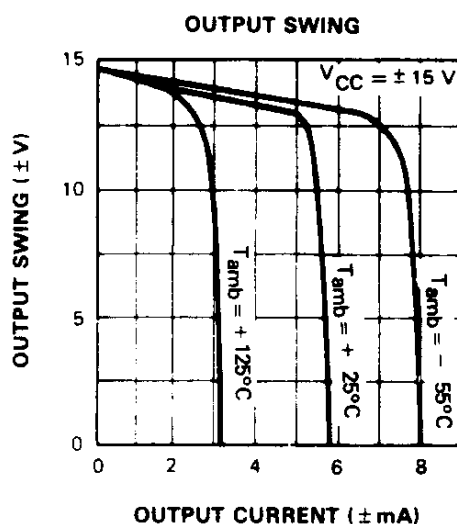
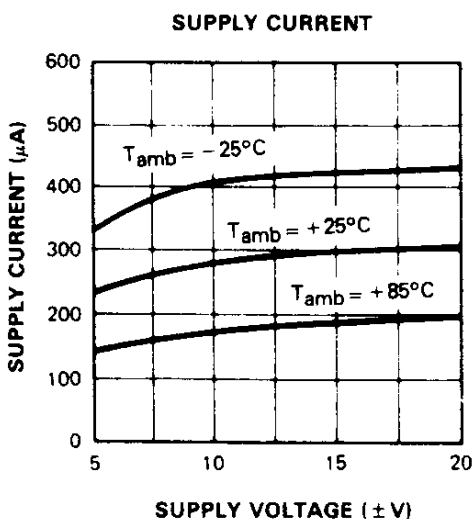

LM208A

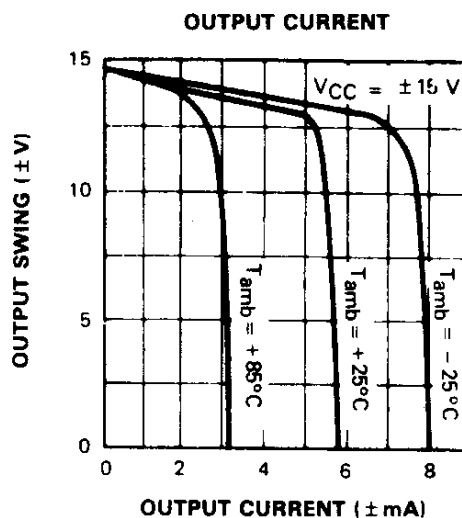
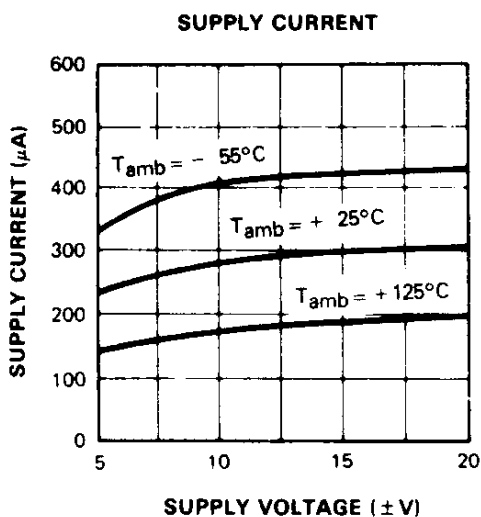

LM308A

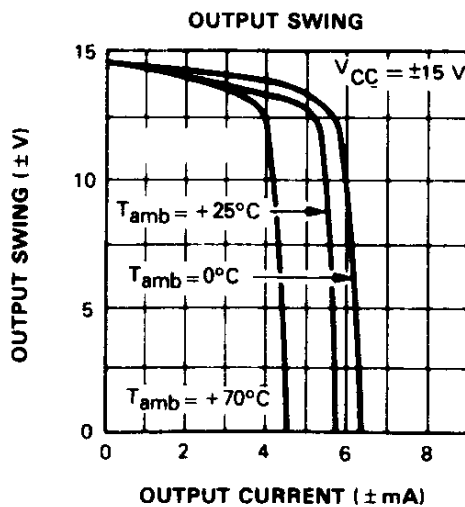
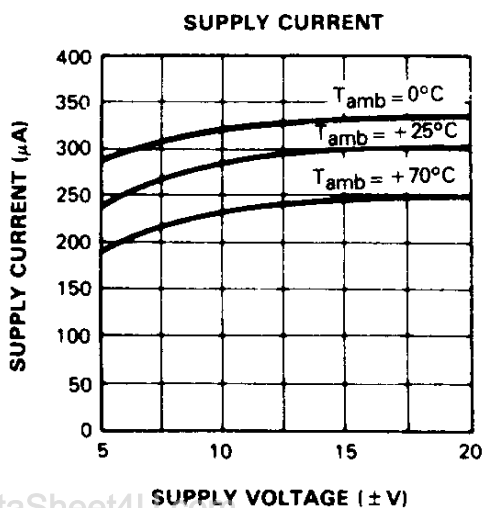

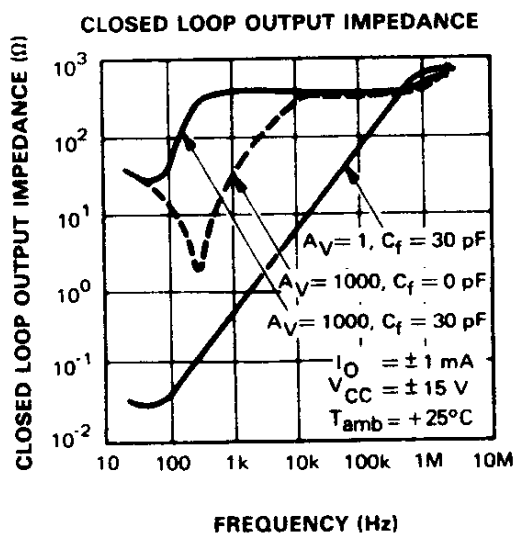
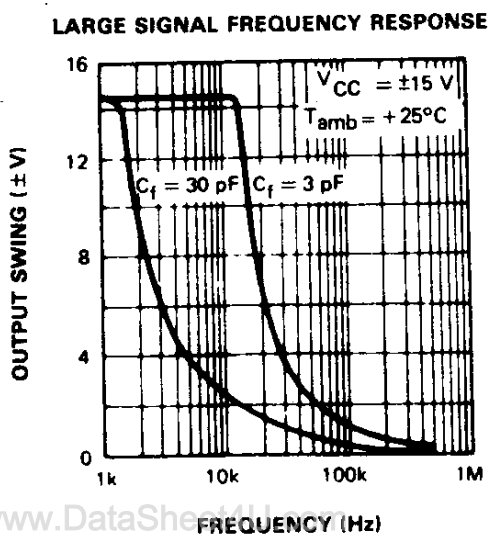
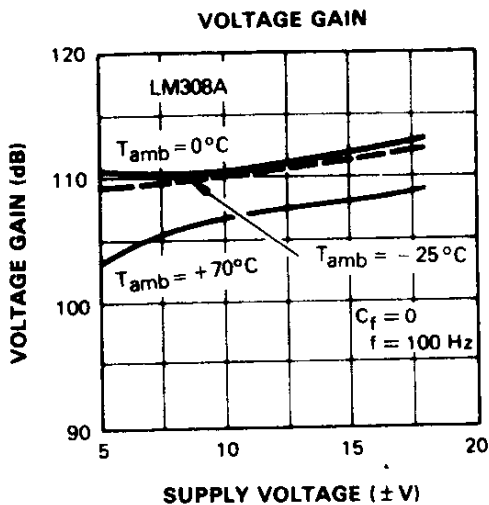
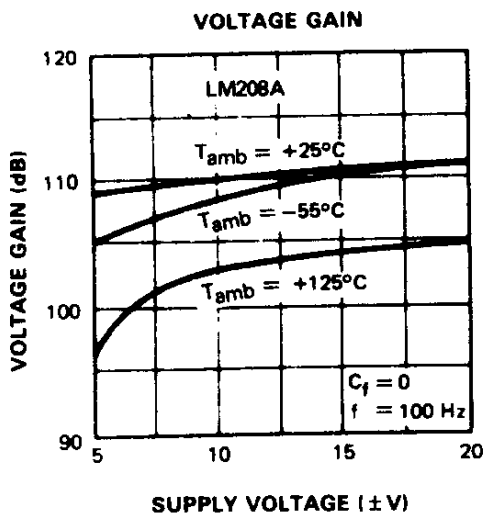
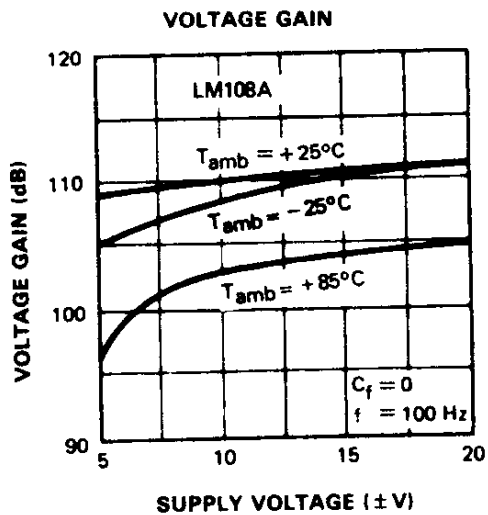

LM108A

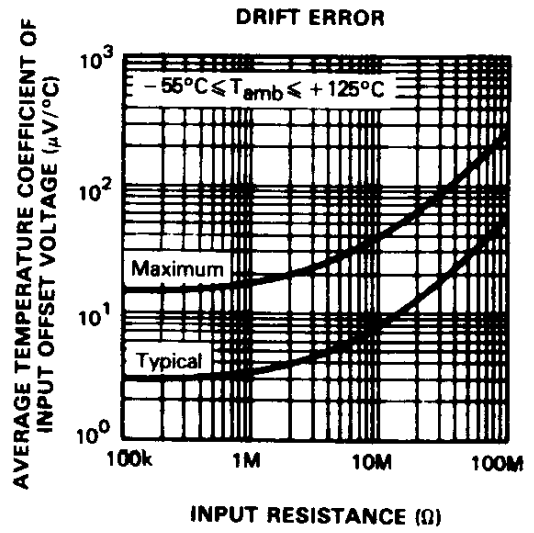
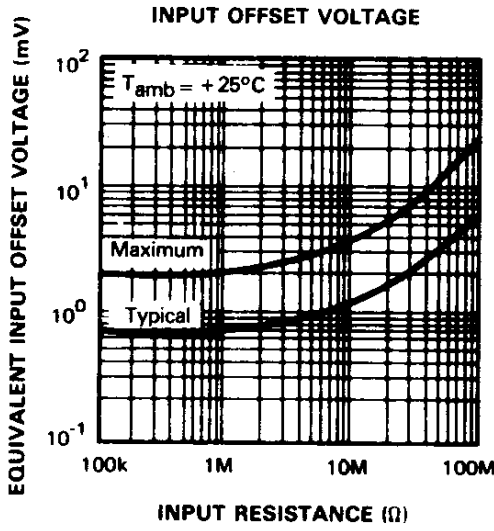

LM108

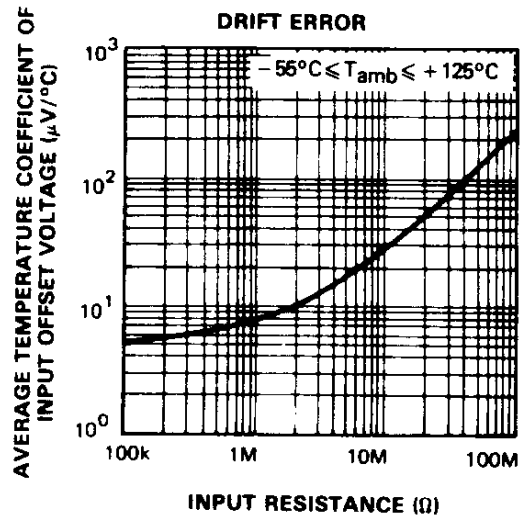
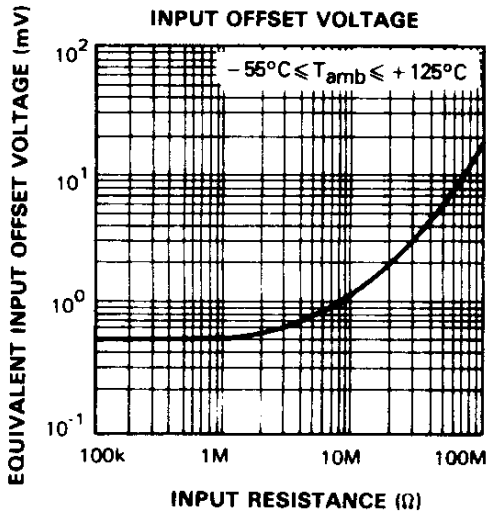

LM208

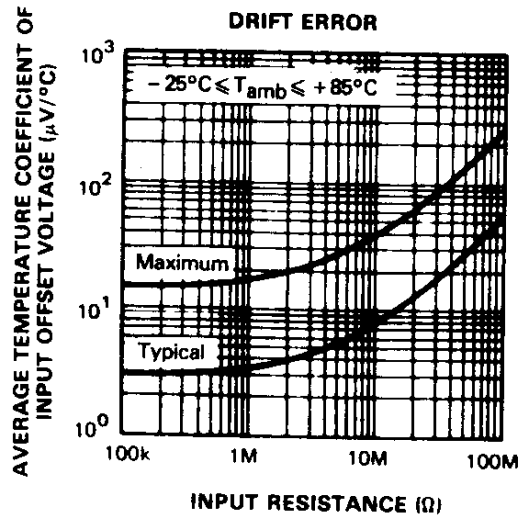
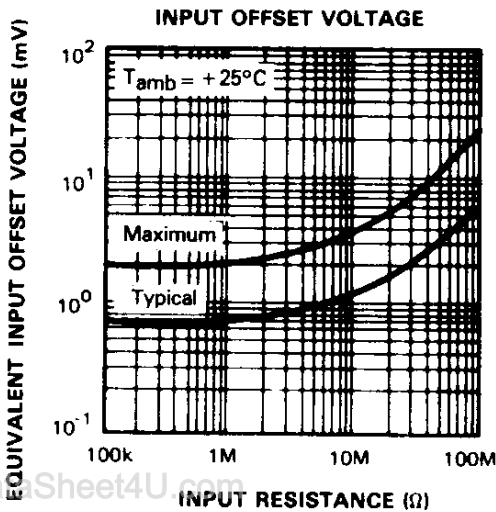

LM208A

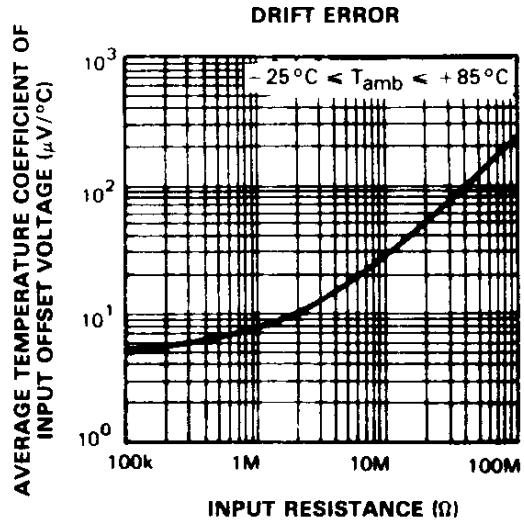
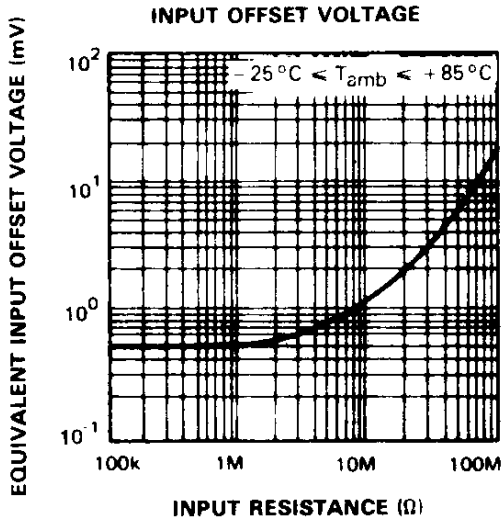

LM308

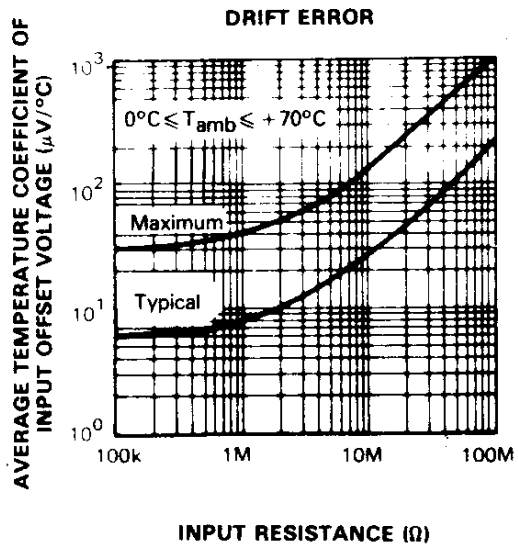
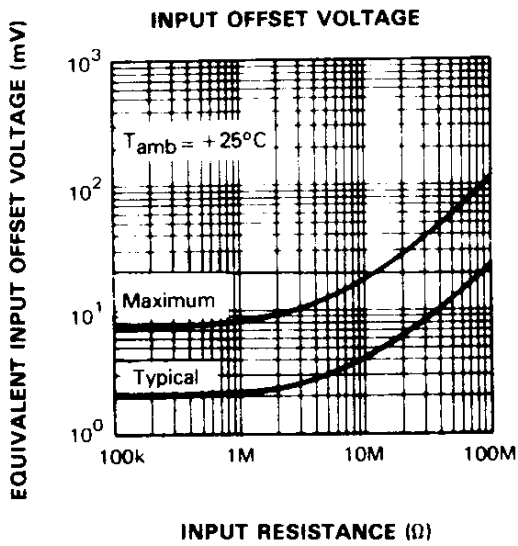

BASIC DIAGRAMS

STANDARD COMPENSATION CIRCUIT

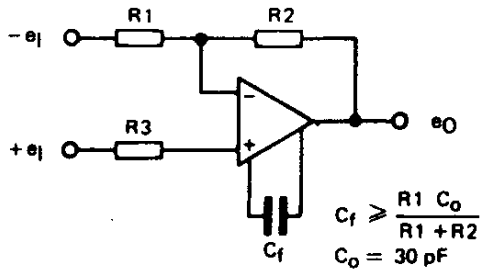

ALTERNATE FREQUENCY COMPENSATION*

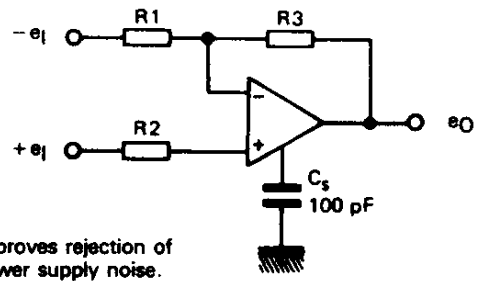

TYPICAL APPLICATIONS

STANDARD FEEDFORWARD

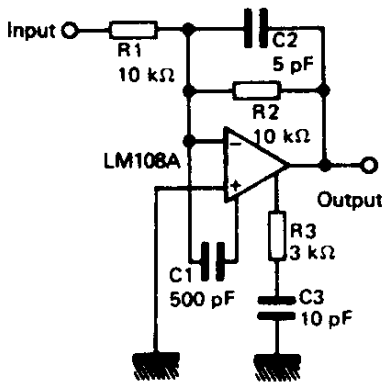

OPEN LOOP VOLTAGE GAIN

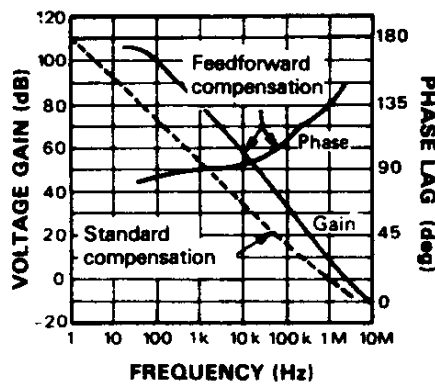

FEEDFORWARD COMPENSATION FOR DECOUPLING LOAD CAPACITANCE

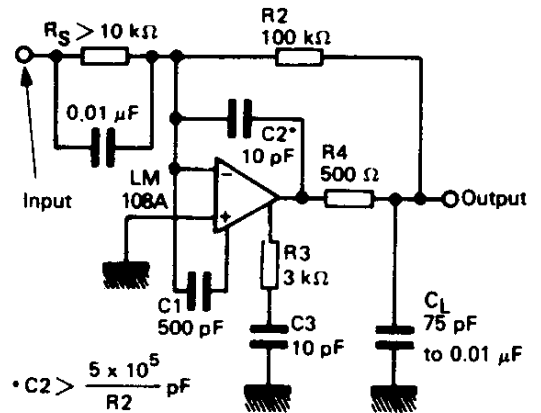

SAMPLE AND HOLD*

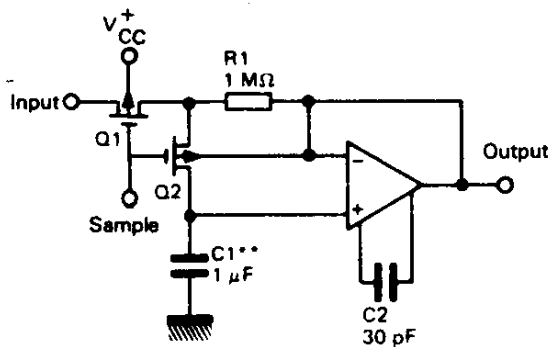

- * Worst case drift less than 2.5 mV/sec.
- ** Teflon, polyethylene or polycarbonate dielectric capacitor.

FAST SUMMING AMPLIFIER

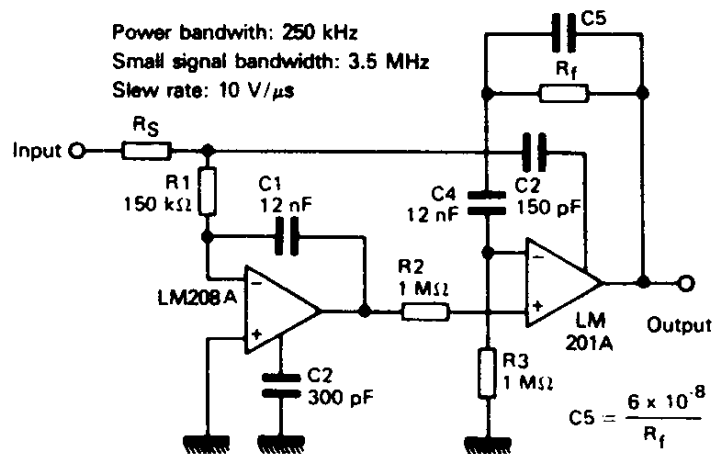

In addition to increasing speed the LM201A raises high and low frequency gain and eliminates thermal feedback.

TYPICAL APPLICATIONS (continued)

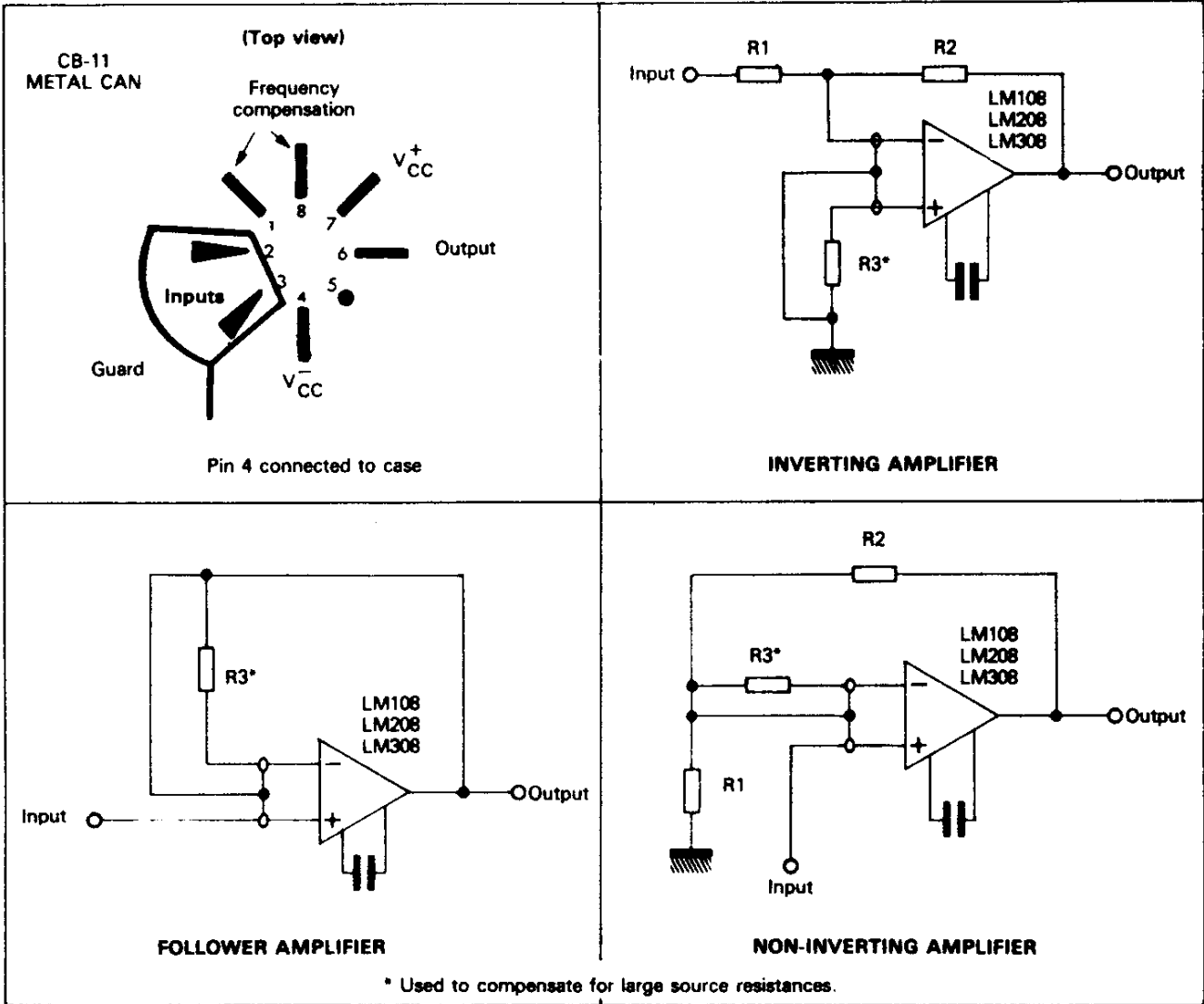

INPUT GUARDING

Leakage currents are on the verge of causing trouble at +125°C. The standard pin configuration of most IC op amps has the input pins adjacent to pins which are the supply potentials. Therefore, it is advisable to employ guarding to reduce the voltage difference between the inputs and adjacent metal runs. A ten-lead pin circle is used, and the leads of the IC are formed so that the holes adjacent to the inputs are vacant when it is inserted in the board. The guard, which is a conductive ring surrounding the inputs, is connected to a low impedance point that is at the same potential as the inputs.

TYPICAL APPLICATION DIAGRAMS

FAST SAMPLE AND HOLD

2N 4391 and 1N 4148 can be replaced by SF.T 7004 analog gate

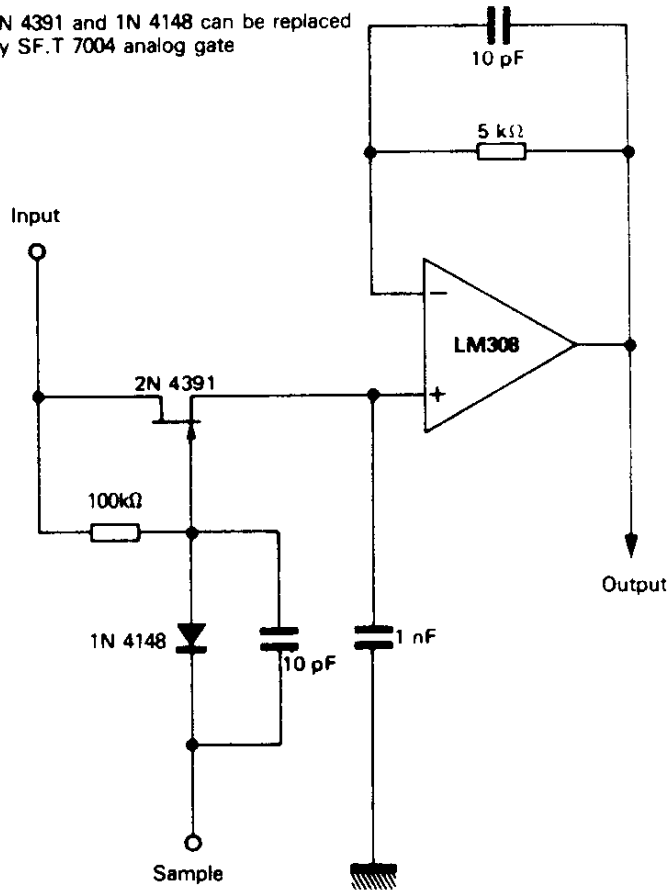

FAST SUMMING AMPLIFIER WITH LOW INPUT CURRENT

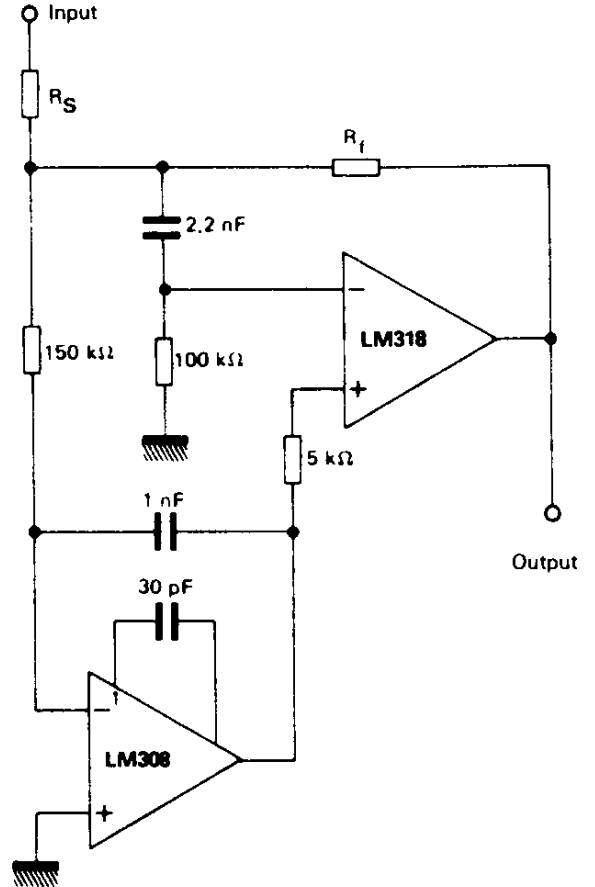

D/A CONVERTER USING LADDER NETWORK

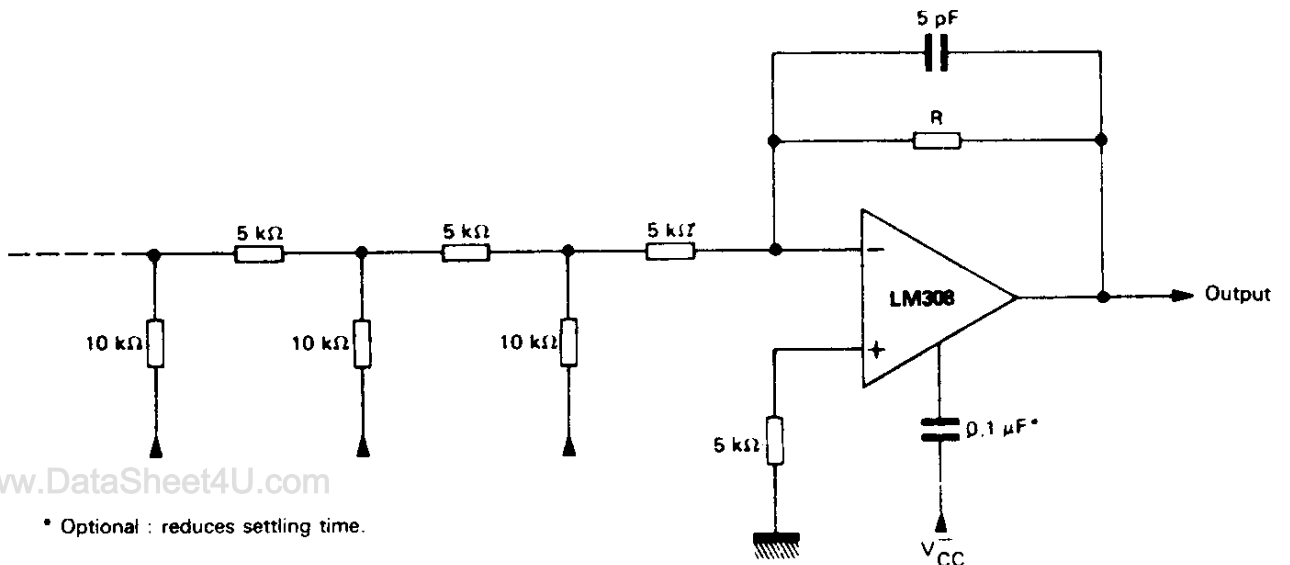

www.DataSheet4U.com

* Optional : reduces settling time.

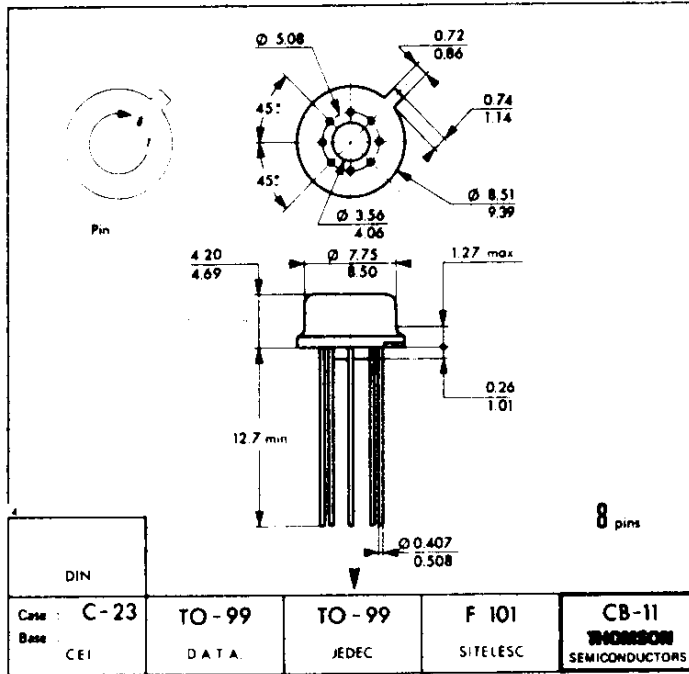

CB-11



H SUFFIX
METAL CAN

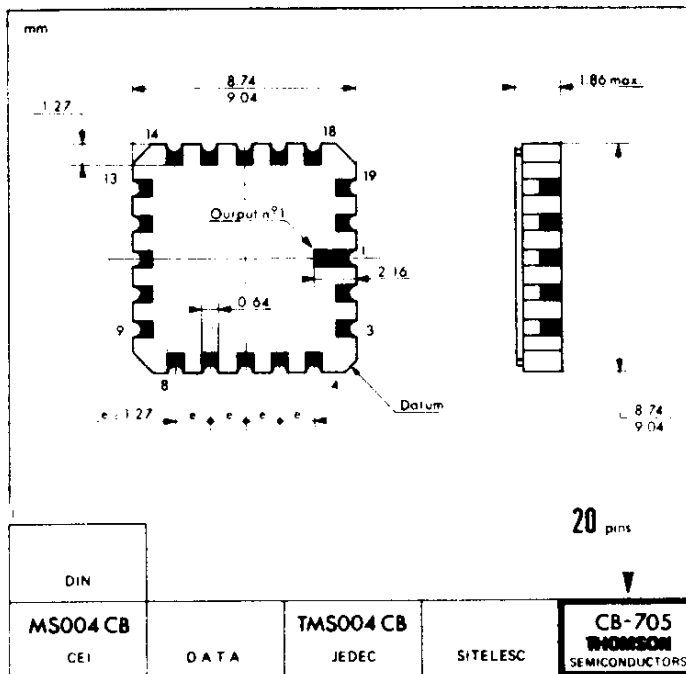

CB-705



GC SUFFIX
TRICOP (LCC)

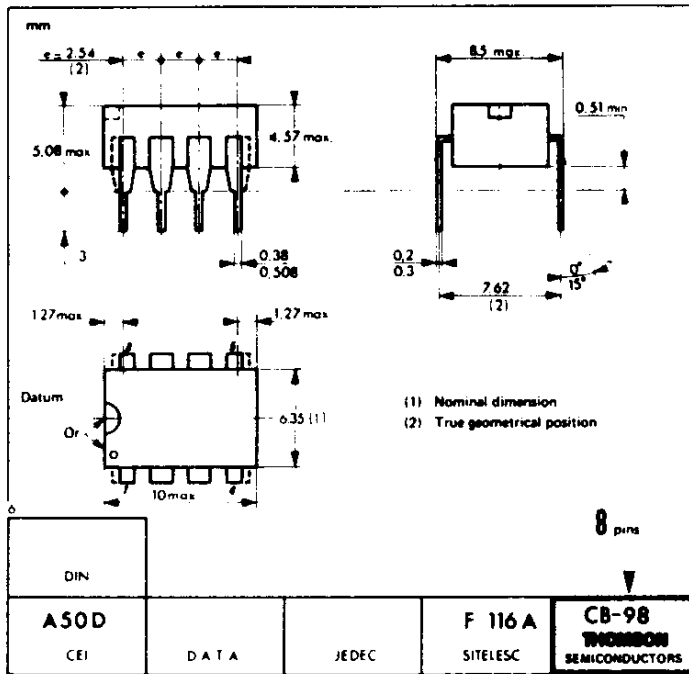

CB-98



DP SUFFIX
PLASTIC PACKAGE

DG SUFFIX
CERDIP PACKAGE

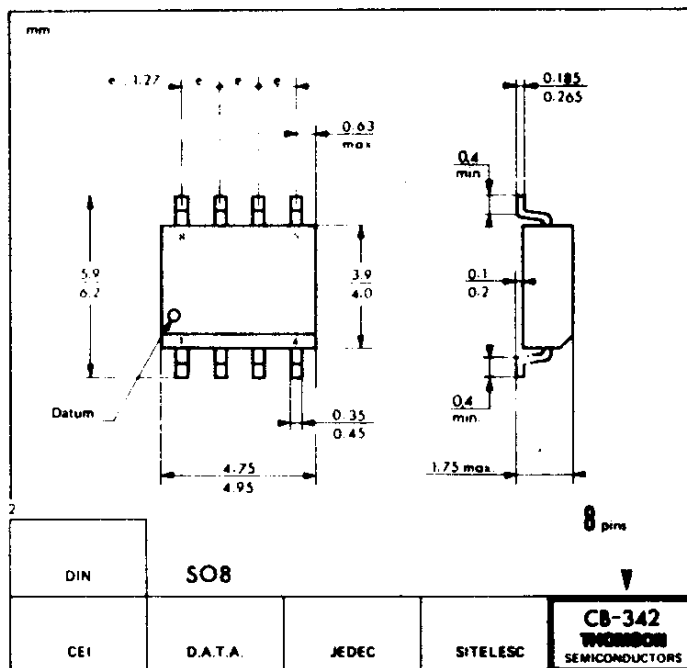

CB-342



FP SUFFIX
PLASTIC
MICROPACKAGE