

Product Specification

## SPECIFICATION FOR APPROVAL

- ( ) Preliminary Specification  
( ● ) Final Specification

<b>Title</b>	<b>26" WUXGA TFT LCD</b>
--------------	--------------------------



BUYER	
MODEL	

SUPPLIER	LG.Philips LCD Co., Ltd.
*MODEL	LM260WU2
SUFFIX	SLA1

\*When you obtain standard approval,  
please use the above model name without suffix.

APPROVED BY	SIGNATURE DATE
/	
/	
/	

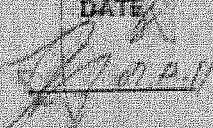
Please return 1 copy for your confirmation with your signature and comments.

APPROVED BY	SIGNATURE DATE
S.E. Hong / G. Manager	 02/12/11
REVIEWED BY	
D.H. Chung / Manager	 02/12/11
PREPARED BY	
K.H. Lee / Engineer	 02/12/11

**MNT Products Engineering Dept.**  
**LG. Philips LCD Co., Ltd**

Product Specification

Contents

No	ITEM	Page
	COVER	1
	CONTENTS	2
	RECORD OF REVISIONS	3
1	GENERAL DESCRIPTION	4
2	ABSOLUTE MAXIMUM RATINGS	5
3	ELECTRICAL SPECIFICATIONS	6
3-1	ELECTRICAL CHARACTREISTICS	6
3-2	INTERFACE CONNECTIONS	8
3-3	SIGNAL TIMING SPECIFICATIONS	12
3-4	SIGNAL TIMING WAVEFORMS	13
3-5	COLOR INPUT DATA REFERNECE	14
3-6	POWER SEQUENCE	15
4	OPTICAL SPECIFICATIONS	17
5	MECHANICAL CHARACTERISTICS	23
6	RELIABLITY	26
7	INTERNATIONAL STANDARDS	27
7-1	SAFETY	27
7-2	EMC	27
8	PACKING	28
8-1	DESIGNATION OF LOT MARK	28
8-2	PACKING FORM	28
9	PRECAUTIONS	29

Product Specification

**RECORD OF REVISIONS**

Revision No	Revision Date	Page	Description
0.0	May.31, 2007	--	First Draft(Preliminary)
0.1	July. 24, 2007	27, 28	Mechanic drawing
0.2	Aug. 8, 2007	4, 6	Electrical Characteristics are updated.
		4,26	LCM Weight is updated.
		18	Power sequence is updated.
0.3	Aug, 27, 2007	27, 28	Back mounting is updated
0.4	Oct, 16, 2007	4	TBD is updated. Typical error of weight is corrected from 3720g to 3270g.
		8	Inverter characteristics are updated.
		20	Color Coordinates are updated.
1.0	DEC,11,2007	20	Color gamut of CIE 1976 is added.

**Product Specification**

**1. General Description**

LM260WU2 is a Color Active Matrix Liquid Crystal Display with an integral Cold Cathode Fluorescent Lamp(CCFL) backlight system. The matrix employs a-Si Thin Film Transistor as the active element. It is a transmissive type display operating in the normally black mode. It has a 25.54 inch diagonally measured active display area with WUXGA resolution (1200 vertical by 1920 horizontal pixel array) Each pixel is divided into Red, Green and Blue sub-pixels or dots which are arranged in vertical stripes. Gray scale or the brightness of the sub-pixel color is determined with a 8-bit gray scale signal for each dot, thus, presenting a palette of more than 16,7M(True) colors. It has been designed to apply the 8Bit 2 port LVDS interface. It is intended to support displays where high brightness, super wide viewing angle, high color saturation, and high color are important.

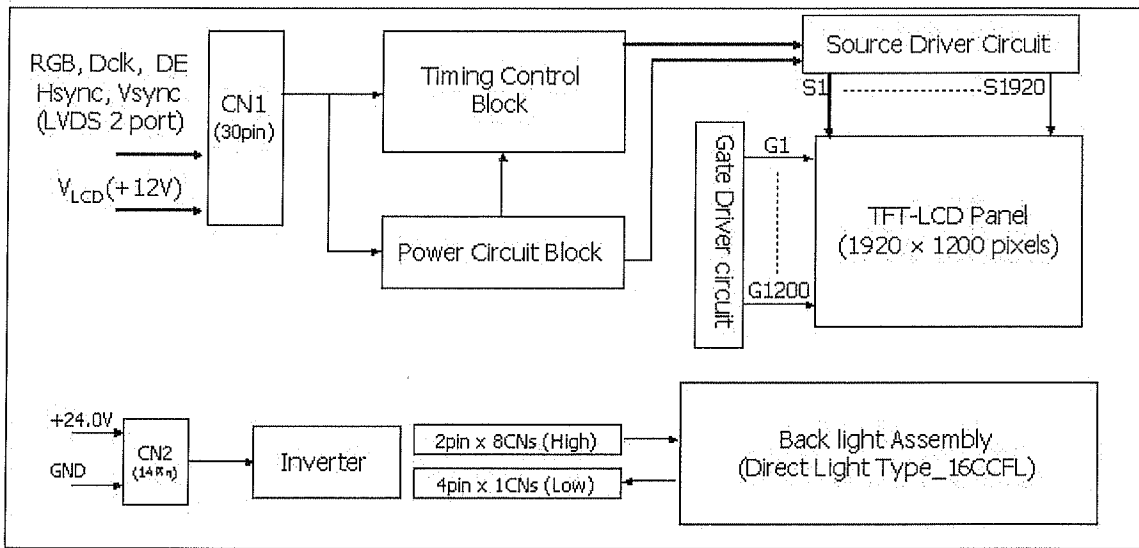

**General Features**

**Figure 1. Block diagram**

Active Screen Size	25.54 inches(64.87cm) diagonal
Outline Dimension	582(H) x 375.6(V) x 41.5(D) mm(Typ.)
Pixel Pitch	0.2865 mm x 0.2865 mm
Pixel Format	1920 horiz. By 1200 vert. Pixels RGB stripes arrangement
Color Depth	8-bit, 16,777,216 colors
Luminance, White	400 cd/m <sup>2</sup> (Center 1 point)
Viewing Angle(CR>10)	View Angle Free (R/L 178(Typ.), U/D 178(Typ.))
Power Consumption	Total 90.78 Watt (Typ.) (6.78 Watt @V <sub>LC</sub> ,84.0 Watt @400cd/m <sup>2</sup> )
Weight	3270 g(typ.)
Display Operating Mode	Transmissive mode, normally black
Surface Treatment	Hard coating(3H), Anti-glare treatment of the front polarizer

Product Specification

2. Absolute Maximum Ratings

The following are maximum values which, if exceeded, may cause faulty operation or damage to the unit.

Table 1. ABSOLUTE MAXIMUM RATINGS

Parameter	Symbol	Values		Units	Notes
		Min	Max		
Power Input Voltage	V <sub>lcd</sub>	-0.3	14	Vdc	at 25 ± 2°C
Operating Temperature	T <sub>op</sub>	0	50	°C	1
Storage Temperature	T <sub>st</sub>	-20	60	°C	
Operating Ambient Humidity	H <sub>op</sub>	10	90	%RH	
Storage Humidity	H <sub>st</sub>	10	90	%RH	

Note : 1. Temperature and relative humidity range are shown in the figure below.  
Wet bulb temperature should be 39 °C Max, and no condensation of water.

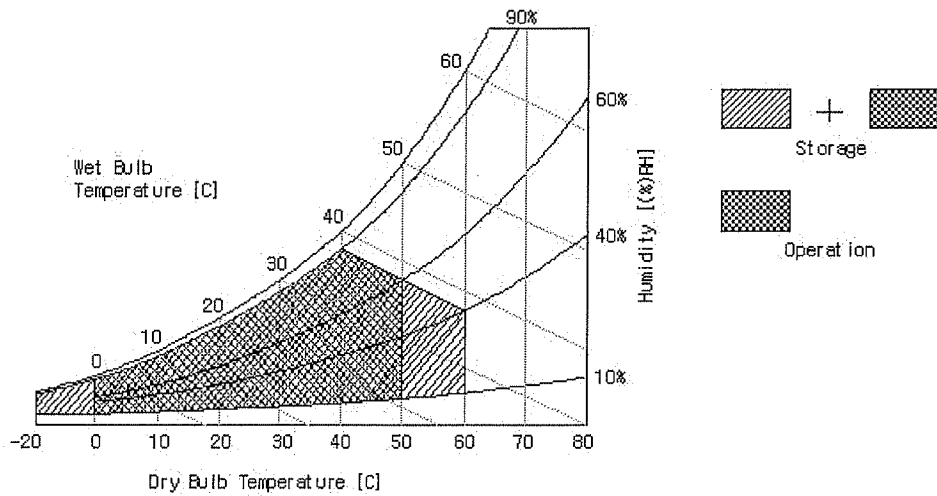

Figure 2. Temperature and relative humidity

Product Specification

**3. Electrical Specifications**

**3-1. Electrical Characteristics**

It requires two power inputs. One is employed to power the LCD electronics and to drive the TFT array and liquid crystal. The second input power for the CCFL, is typically generated by an inverter. The inverter is an external unit to the LCDs.

Table 2-1. ELECTRICAL CHARACTERISTICS

Parameter	Symbol	Values			Unit	Notes
		Min	Typ	Max		
MODULE :						
Power Supply Input Voltage	V <sub>LCD</sub>	11.4	12.0	12.6	V <sub>dc</sub>	
Permissive Power Input Ripple	V <sub>dRF</sub>			400	mV <sub>pp</sub>	1
Differential Impedance	Z <sub>m</sub>	90	100	110	Ohm	
Power Supply Input Current	I <sub>LCD</sub>	-	565	680	mA	2
		-	755	910	mA	3
Power Consumption	P <sub>c</sub> TYP	-	6.78	8.16	Watt	2
	P <sub>c</sub> MAX	-	9.06	10.92	Watt	3
Rush current	I <sub>RUSH</sub>	-	-	3.0	A	4

Note :

- Permissive power ripple should be measured under V<sub>CC</sub>=5.0V, 25°C, f<sub>V</sub>(frame frequency)=MAX condition and At that time, we recommend the bandwidth configuration of oscilloscope is to be under 20Mhz. See the next page.
- The specified current and power consumption are under the V<sub>LCD</sub>=12.0V, 25 ± 2°C, f<sub>V</sub>=60Hz condition whereas Mosaic and max power pattern shown in the [ Figure 3 ] is displayed.
- The current is specified at the maximum current pattern.
- Maximum Condition of Inrush current :  
The duration of rush current is about 2ms and rising time of Input Voltage is 1ms(min.).  
At any rising time of Input voltage, Keep the I2T Value by below Condition  
Condition : I2T < 32\*2ms

Product Specification

- **Permissive Power input ripple** (VCC=5.0V, 25°C, fV(frame frequency)=MAX condition)

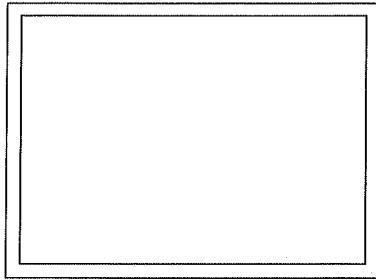

White pattern

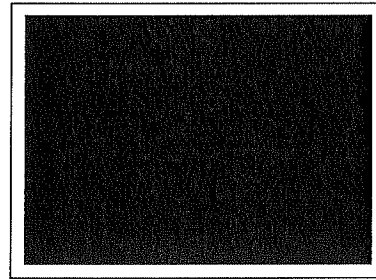

Black pattern

- **Power consumption** (VCC=5.0V, 25°C, fV (frame frequency)=60Hz condition)

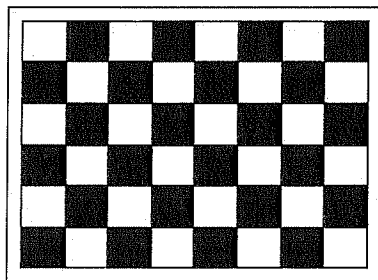

Typical power Pattern

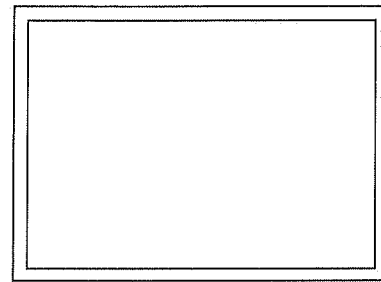

Max power Pattern

Figure 3. Mosaic pattern & Black Pattern for power consumption measurement

Product Specification

Table 2-2. INVERTER ELECTRICAL CHARACTERISTICS

Parameter	Symbol	Condition	Values			Unit	Notes
			Min.	Typ.	Max.		
<b>Inverter :</b>							
Input Voltage	$V_{DDB}$		22	24.0	26	V	1
Input Current	$I_{DDB}$	$V_{BR} = 3.3V$	-	3.35	4.0	A	2
Input Power	PB	$V_{BR} = 3.3V$	-	84.0	101.0	Watt	2
B/L on/off control	VON/OFF	Lamp ON = High	2.0	-	5.0	V	
		Lamp OFF =Low.	0.0	-	0.8	V	
Brightness Adj	VBR		0.5	-	3.3	V	
<b>LAMP :</b>							
Life time			40,000			Hrs	3

Notes :

1. The input voltage ripple is limited below 400mVp-p.
2. The specified current and power consumption are under the typical supply Input voltage, 24V.
3. The life is determined as the time at which luminance of the lamp is 50% compared to that of initial value at the typical lamp current on condition of continuous operating at  $25 \pm 2^{\circ}C$ .
4. Electrical characteristics are determined after the unit has been 'ON' and stable for approximately 30min in a dark environment at  $25^{\circ}C \pm 2^{\circ}C$ .



**Product Specification**

**3-2. Interface Connections**

This LCD employs Two interface connections, a 30 pin connector is used for the module electronics and a 14Pin Connector is used for the integral backlight system.

**3-2-1. LCD Module**

- LCD Connector(CN1): KDF71G-30S-1H, (Manufactured by Hirose )
- Mating Connector : FI-X30C2L (Manufactured by JAE) or Equivalent

**Table 3 MODULE CONNECTOR(CN1) PIN CONFIGURATION**

No	Symbol	Description	No	Symbol	Description
1	FR0M	Minus signal of odd channel 0 (LVDS)	16	SR1P	Plus signal of even channel 1 (LVDS)
2	FR0P	Plus signal of odd channel 0 (LVDS)	17	GND	Ground
3	FR1M	Minus signal of odd channel 1 (LVDS)	18	SR2M	Minus signal of even channel 2 (LVDS)
4	FR1P	Plus signal of odd channel 1 (LVDS)	19	SR2P	Plus signal of even channel 2 (LVDS)
5	FR2M	Minus signal of odd channel 2 (LVDS)	20	SCLKINM	Minus signal of even clock channel (LVDS)
6	FR2P	Plus signal of odd channel 2 (LVDS)	21	SCLKINP	Plus signal of even clock channel (LVDS)
7	GND	Ground	22	SR3M	Minus signal of even channel 3 (LVDS)
8	FCLKINM	Minus signal of odd clock channel (LVDS)	23	SR3P	Plus signal of even channel 3 (LVDS)
9	FCLKINP	Plus signal of odd clock channel (LVDS)	24	GND	Ground
10	FR3M	Minus signal of odd channel 3 (LVDS)	25	NC	No Connection
11	FR3P	Plus signal of odd channel 3 (LVDS)	26	NC	No Connection
12	SR0M	Minus signal of even channel 0 (LVDS)	27	DCR_OUT	Dynamic C/R output
13	SR0P	Plus signal of even channel 0 (LVDS)	28	NC	No Connection
14	GND	Ground	29	V <sub>Lcd</sub>	Power Supply +12.0V
15	SR1M	Minus signal of even channel 1 (LVDS)	30	V <sub>Lcd</sub>	Power Supply +12.0V

- Note:
1. All GND(ground) pins should be connected together and to V<sub>ss</sub> which should also be connected to the LCD's metal frame.
  2. All V<sub>Lcd</sub> (power input) pins should be connected together.
  3. Input Level of LVDS signal is based on the IEA 664 Standard.

**Rear view of LCM**

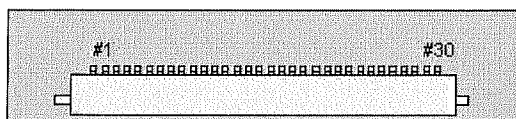

**KDF71G-30S-1H**



**[ Figure 4 ] Connector diagram**

Product Specification

**Table 4. REQUIRED SIGNAL ASSIGNMENT FOR Flat Link (TI:SN75LVDS83) Transmitter**

Pin #	Pin Name	Require Signal	Pin #	Pin Name	Require Signal
1	Vcc	Power Supply for TTL Input	29	GND	Ground pin for TTL
2	D5	TTL Input (R7)	30	D26	TTL Input (DE)
3	D6	TTL Input (R5)	31	Tx CLKIN	TTL Level clock Input
4	D7	TTL Input (G0)	32	PWR DWN	Power Down Input
5	GND	Ground pin for TTL	33	PLL GND	Ground pin for PLL
6	D8	TTL Input (G1)	34	PLL Vcc	Power Supply for PLL
7	D9	TTL Input (G2)	35	PLL GND	Ground pin for PLL
8	D10	TTL Input (G6)	36	LVDS GND	Ground pin for LVDS
9	Vcc	Power Supply for TTL Input	37	TxOUT3 +	Positive LVDS differential data output 3
10	D11	TTL Input (G7)	38	TxOUT3 -	Negative LVDS differential data output 3
11	D12	TTL Input (G3)	39	Tx CLKOUT +	Positive LVDS differential clock output
12	D13	TTL Input (G4)	40	Tx CLKOUT -	Negative LVDS differential clock output
13	GND	Ground pin for TTL	41	Tx OUT2 +	Positive LVDS differential data output 2
14	D14	TTL Input (G5)	42	Tx OUT2 -	Negative LVDS differential data output 2
15	D15	TTL Input (B0)	43	LVDS GND	Ground pin for LVDS
16	D16	TTL Input (B6)	44	LVDS Vcc	Power Supply for LVDS
17	Vcc	Power Supply for TTL Input	45	Tx OUT1 +	Positive LVDS differential data output 1
18	D17	TTL Input (B7)	46	Tx OUT1 -	Negative LVDS differential data output 1
19	D18	TTL Input (B1)	47	Tx OUT0 +	Positive LVDS differential data output 0
20	D19	TTL Input (B2)	48	Tx OUT0 -	Negative LVDS differential data output 0
21	GND	Ground pin for TTL Input	49	LVDS GND	Ground pin for LVDS
22	D20	TTL Input (B3)	50	D27	TTL Input (R6)
23	D21	TTL Input (B4)	51	D0	TTL Input (R0)
24	D22	TTL Input (B5)	52	D1	TTL Input (R1)
25	D23	TTL Input (RSVD)	53	GND	Ground pin for TTL
26	Vcc	Power Supply for TTL Input	54	D2	TTL Input (R2)
27	D24	TTL Input (HSYNC)	55	D3	TTL Input (R3)
28	D25	TTL Input (VSYNC)	56	D4	TTL Input (R4)

Notes : Refer to LVDS Transmitter Data Sheet for detail descriptions.

Product Specification

LVDS Input characteristics

1. DC Specification

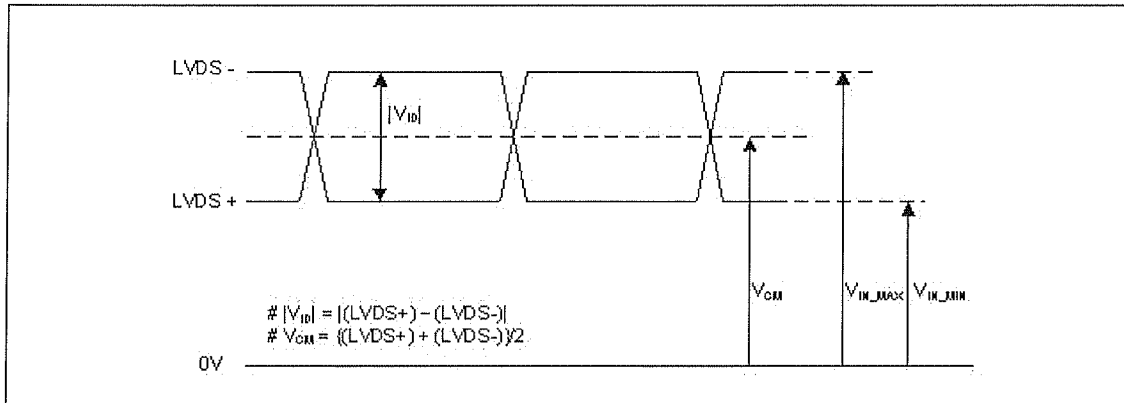

Description	Symbol	Min	Max	Unit	Notes
LVDS Differential Voltage	$ V_{ID} $	100	600	mV	-
LVDS Common mode Voltage	$V_{CM}$	0.6	1.8	V	-
LVDS Input Voltage Range	$V_{IN}$	0.3	2.1	V	-

2. AC Specification

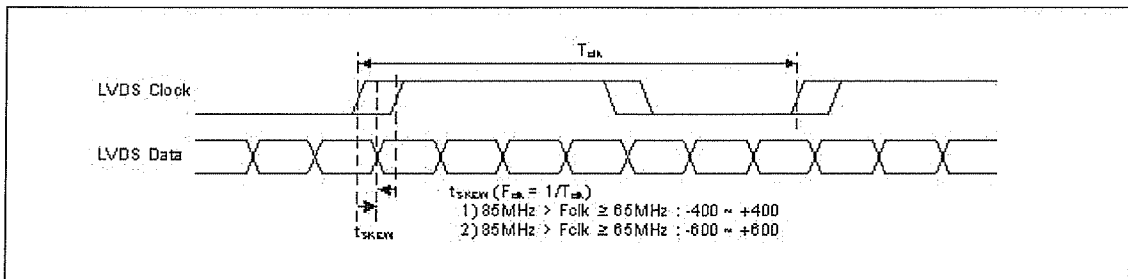

Description	Symbol	Min	Max	Unit	Notes
LVDS Clock to Data Skew Margin	$t_{SKEW}$	-400	+400	ps	85MHz > F <sub>clk</sub> ≥ 65MHz.
	$t_{SKEW}$	-600	+600	ps	65MHz > F <sub>clk</sub> ≥ 25MHz
LVDS Clock to Clock Skew Margin (Even to Odd)	$t_{SKEW\_EO}$	-1/7	+1/7	$T_{clk}$	-
Maximum deviation of input clock frequency during SSC	$F_{DEV}$	-	±3	%	-
Maximum modulation frequency of input clock during SSC	$F_{MOD}$	-	200	KHz	-

Product Specification

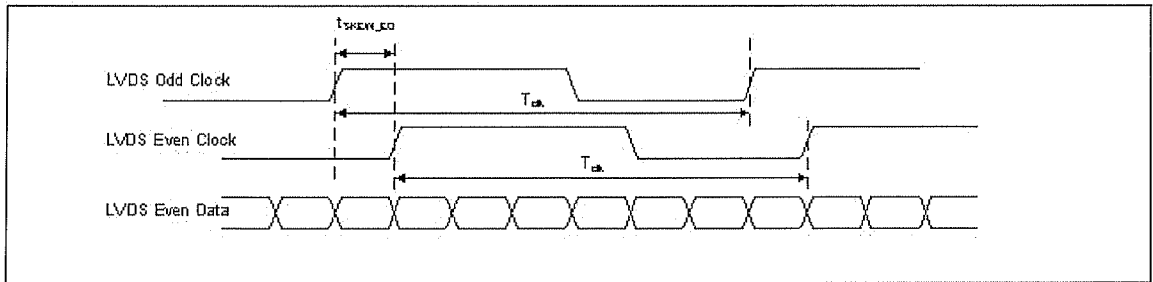

< Clock skew margin between channel >

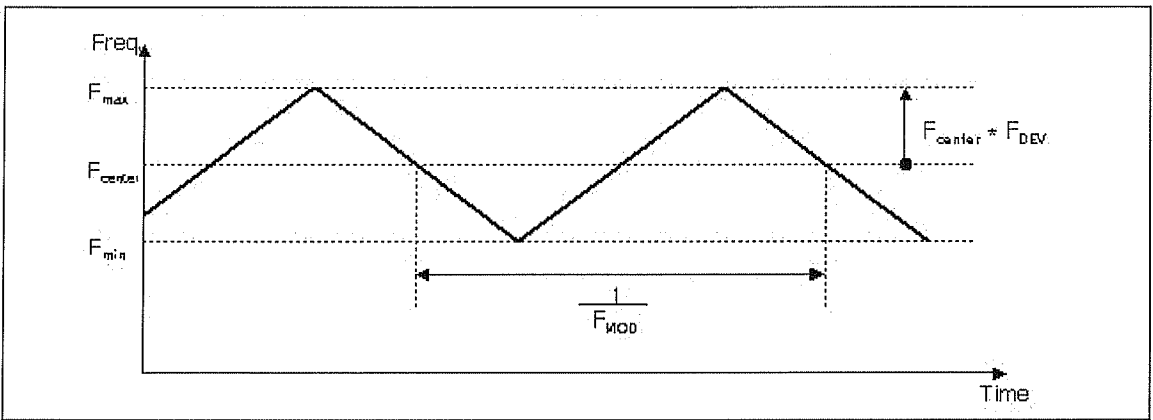

< Spread Spectrum >

3. Data Format  
1) LVDS 2 Port

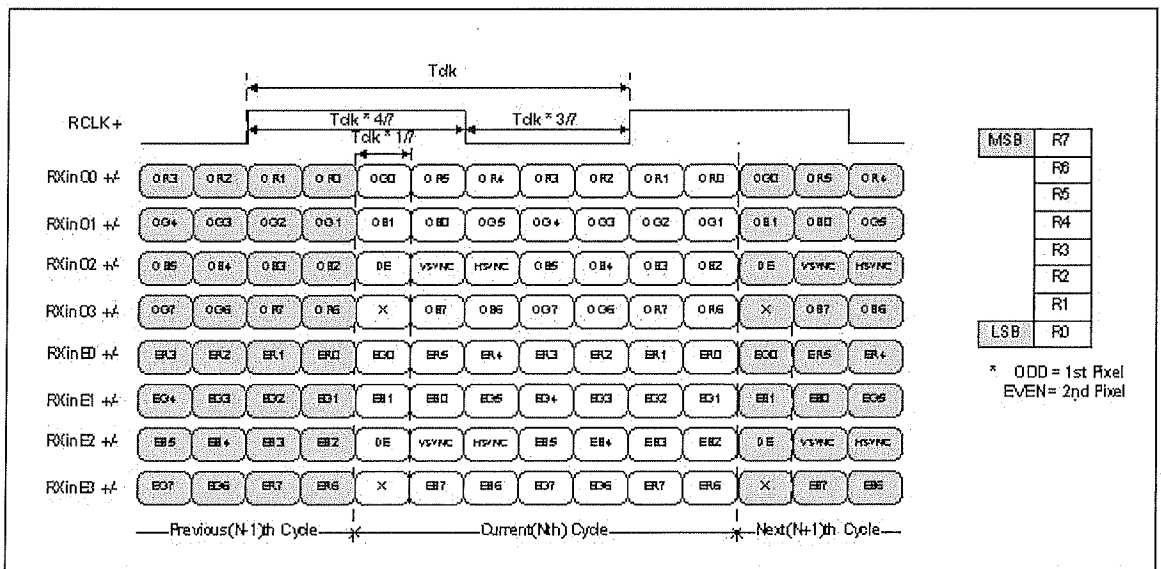

< LVDS Data Format >

**Product Specification**

2) LVDS 1 Port

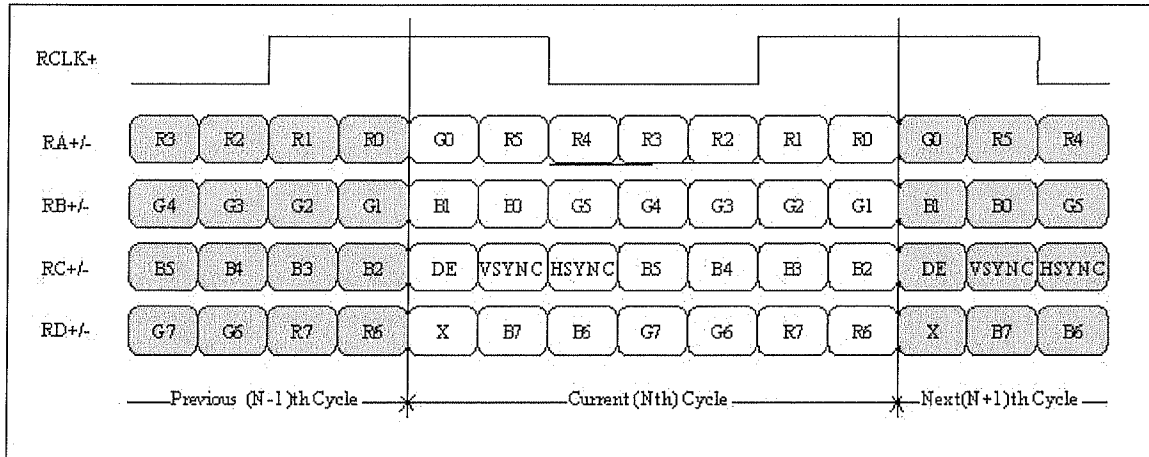

Product Specification

3-2-2. Backlight Interface

- Inverter Connector : S14B-PHA-SM3 Side entry type (Manufactured by JST) or Equivalent
- Mating Connector : PHR-14(Manufactured by JST) or Equivalent

Table 4. INVERTER CONNECTOR PIN CONFIGURATION

Pin No	Symbol	Description	Remarks
1	V <sub>BL</sub>	Power Supply +24.0V	
2	V <sub>BL</sub>	Power Supply +24.0V	
3	V <sub>BL</sub>	Power Supply +24.0V	
4	V <sub>BL</sub>	Power Supply +24.0V	
5	V <sub>BL</sub>	Power Supply +24.0V	
6	GND	Power Ground	Note 1
7	GND	Power Ground	
8	GND	Power Ground	
9	GND	Power Ground	
10	GND	Power Ground	
11	OPEN	NC	
12	V <sub>ON</sub>	Backlight On/off Signal	(On :2.0V~5V/Off :0.0~0.8V)
13	V <sub>BR</sub>	Brightness Adjustable Voltage	(Max :3.3V / Min :0.5V)
14	OPEN	NC	

Notes : 1. GND is connected to the LCD's metal frame.

Rear view of LCM

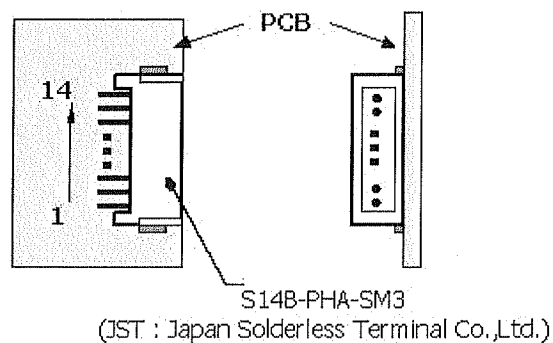

[ Figure 5 ] Inverter connector view

Product Specification

**3-3. Signal Timing Specifications**

This is signal timing required at the input of the TMDS transmitter. All of the interface signal timing should be satisfied with the following specifications for its proper operation.

**Table 5. TIMING TABLE (VESA COORDINATED VIDEO TIMING)**

ITEM		SYMBOL	Min	Typ	Max	Unit	Note
DCLK	Period	tCLK	6.58	6.49	6.41	ns	
	Frequency	fCLK	152	154	156	MHz	Pixel frequency 154MHz
Hsync	Period	tHP	2072	2080	2088	tCLK	
	Width-Active	tWH	32	32	32		
Vsync	Period	tVP	1233	1235	1237	tHP	
	Frequency	fV	58.85	59.95	61	Hz	
	Width-Active	tWV	6	6	6	tHP	
Data	Horizontal Valid	tHV	1920	1920	1920	tCLK	
	Horizontal Back Porch	tHBP	72	80	88		
	Horizontal Front Porch	tHFP	40	48	56		
	Horizontal Blank	-	152	160	168		tWH + tHBP + tHFP
Enable	Vertical Valid	tVW	1200	1200	1200	tHP	
	Vertical Back Porch	tVBP	25	26	27		
	Vertical Front Porch	tVFP	2	3	4		
	Vertical Blank	-	33	35	37		tWV + tVBP + tVFP

Note: Hsync period and Hsync width-active should be even number times of tCLK. If the value is odd number times of tCLK, display control signal can be asynchronous. In order to operate this LCM a Hsync, Vsyn, and DE(data enable) signals should be used.

1. The performance of the electro-optical characteristics may be influenced by variance of the vertical refresh rates.
2. Vsync and Hsync should be keep the above specification.
3. Hsync Period, Hsync Width, and Horizontal Back Porch should be any times of of character number(8).
4. The polarity of Hsync, Vsync is not restricted.

**Product Specification**

**3-4. Signal Timing Waveforms**

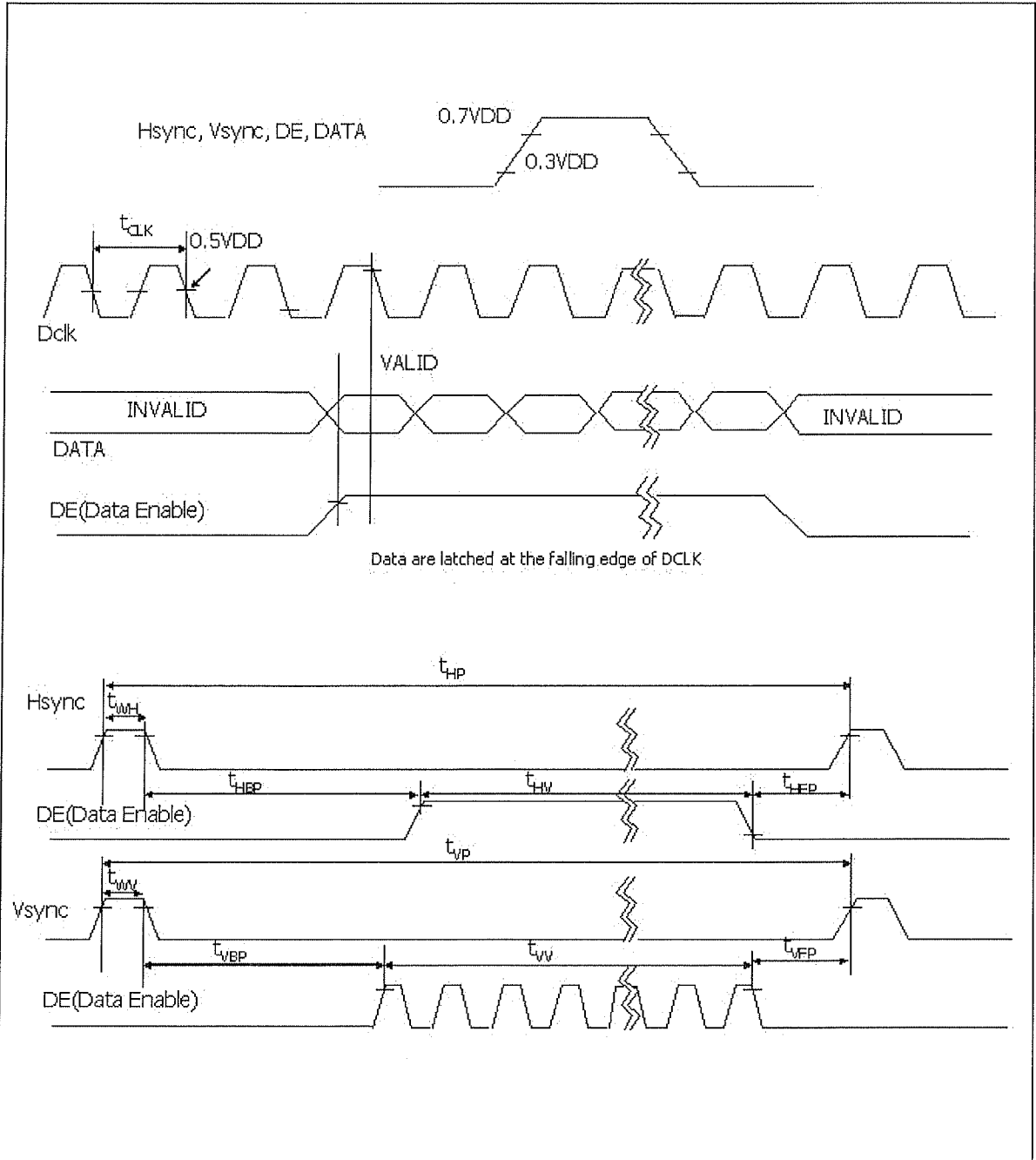



Product Specification

**3-5. Color Data Reference**

The Brightness of each primary color (red, green, blue) is based on the 8-bit gray scale data input for the color; the higher the binary input, the brighter the color. The table below provides a reference for color versus data input.

Table 6. COLOR DATA REFERENCE

Color		Input Color Data																							
		RED								GREEN								BLUE							
		MSB				LSB				MSB				LSB				MSB				LSB			
		R7	R6	R5	R4	R3	R2	R1	R0	G7	G6	G5	G4	G3	G2	G1	G0	B7	B6	B5	B4	B3	B2	B1	B0
Basic Color	Black	0	0	0	0	0	0	0	0	0	0	0	0	0	0	0	0	0	0	0	0	0	0	0	0
	Red (255)	1	1	1	1	1	1	1	1	0	0	0	0	0	0	0	0	0	0	0	0	0	0	0	0
	Green (255)	0	0	0	0	0	0	0	0	1	1	1	1	1	1	1	1	0	0	0	0	0	0	0	0
	Blue (255)	0	0	0	0	0	0	0	0	0	0	0	0	0	0	0	0	1	1	1	1	1	1	1	1
	Cyan	0	0	0	0	0	0	0	0	1	1	1	1	1	1	1	1	1	1	1	1	1	1	1	1
	Magenta	1	1	1	1	1	1	1	1	0	0	0	0	0	0	0	0	1	1	1	1	1	1	1	1
	Yellow	1	1	1	1	1	1	1	1	1	1	1	1	1	1	1	1	0	0	0	0	0	0	0	0
	White	1	1	1	1	1	1	1	1	1	1	1	1	1	1	1	1	1	1	1	1	1	1	1	1
RED	RED (000) Dark	0	0	0	0	0	0	0	0	0	0	0	0	0	0	0	0	0	0	0	0	0	0	0	0
	RED (001)	0	0	0	0	0	0	0	1	0	0	0	0	0	0	0	0	0	0	0	0	0	0	0	0
	...	...								...								...							
	RED (254)	1	1	1	1	1	1	1	0	0	0	0	0	0	0	0	0	0	0	0	0	0	0	0	0
	RED (255)	1	1	1	1	1	1	1	1	0	0	0	0	0	0	0	0	0	0	0	0	0	0	0	0
GREEN	GREEN (000) Dark	0	0	0	0	0	0	0	0	0	0	0	0	0	0	0	0	0	0	0	0	0	0	0	0
	GREEN (001)	0	0	0	0	0	0	0	0	0	0	0	0	0	0	0	1	0	0	0	0	0	0	0	0
	...	...								...								...							
	GREEN (254)	0	0	0	0	0	0	0	0	1	1	1	1	1	1	1	0	0	0	0	0	0	0	0	0
	GREEN (255)	0	0	0	0	0	0	0	0	1	1	1	1	1	1	1	1	0	0	0	0	0	0	0	0
BLUE	BLUE (000) Dark	0	0	0	0	0	0	0	0	0	0	0	0	0	0	0	0	0	0	0	0	0	0	0	0
	BLUE (001)	0	0	0	0	0	0	0	0	0	0	0	0	0	0	0	0	0	0	0	0	0	0	0	1
	...	...								...								...							
	BLUE (254)	0	0	0	0	0	0	0	0	0	0	0	0	0	0	0	0	1	1	1	1	1	1	1	0
	BLUE (255)	0	0	0	0	0	0	0	0	0	0	0	0	0	0	0	0	1	1	1	1	1	1	1	1

Product Specification

**3-6. Power Sequence**

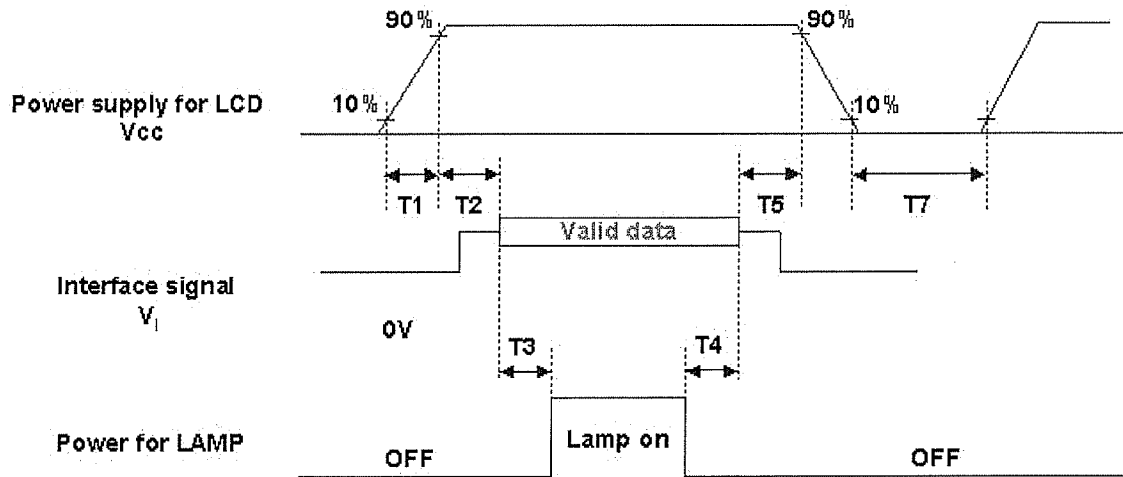

Table 7. POWER SEQUENCE

Parameter	Values			Units
	Min	Typ	Max	
T1	0.5	-	10	ms
T2	0.01	-	50	ms
T3	500	-	-	ms
T4	200	-	-	ms
T5	0.01	-	50	ms
T7	500	-	-	ms

- Notes :
1. Please avoid floating state of interface signal at invalid period.
  2. When the interface signal is invalid, be sure to pull down the power supply for LCD  $V_{LCD}$  to 0V.
  3. Lamp power must be turn on after power supply for LCD and interface signal are valid.

Product Specification

3-7. Power Sequence for Inverter

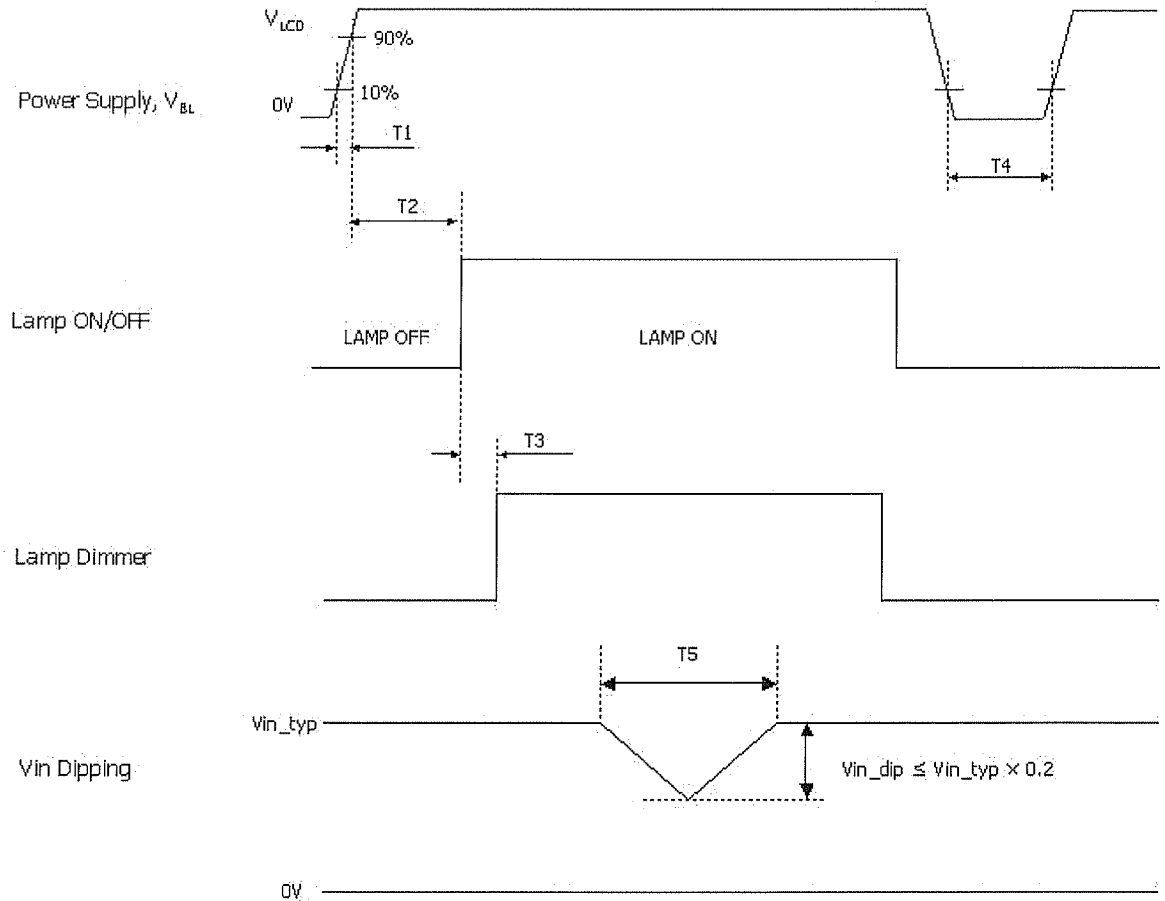

Table 8. POWER SEQUENCE

Parameter	Values			Units
	Min	Typ	Max	
T1	1	-	30	ms
T2	200	-	-	ms
T3	-	-	50	ms
T4	500	-	-	ms
T5	-	-	10	ms

Product Specification

4. Optical Specifications

Optical characteristics are determined after the unit has been 'ON' for approximately 30 minutes in a dark environment at  $25 \pm 2^\circ\text{C}$ . The values specified are at an approximate distance 50cm from the LCD surface at a viewing angle of  $\Phi$  and  $\theta$  equal to  $0^\circ$  and aperture 1 degree.

FIG. 1 presents additional information concerning the measurement equipment and method.

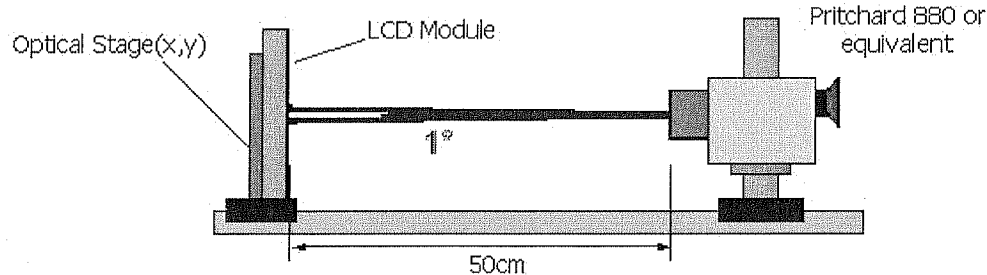

FIG. 6 Optical Characteristic Measurement Equipment and Method

Table 9. OPTICAL CHARACTERISTICS (Ta=25 °C, VLCD=12.0V, fv=60Hz Dclk=154MHz, VBR=3.3V)

Parameter	Symbol	Values			Units	Notes
		Min	Typ	Max		
Contrast Ratio	CR	700	1000			1
Surface Luminance, white	L <sub>WH</sub>	320	400		cd/m <sup>2</sup>	2
Luminance Variation	$\delta_{\text{WHITE}}$	75			%	3
Response Time	Rise Time	T <sub>R</sub>	5.5	12	ms	4
	Decay Time	T <sub>D</sub>	6.5	12	ms	4
	Gray to Gray	T <sub>GTG_AVR</sub>	5	-	ms	5
		T <sub>GTG_MAX</sub>	-	-	12	ms
Color Coordinates [CIE1931]	RED	Rx		0.677		
		Ry		0.312		
	GREEN	Gx		0.210		
		Gy	Typ	0.687	Typ	
	BLUE	Bx	-0.03	0.150	+0.03	
		By		0.054		
	WHITE	Wx		0.313		
	Wy		0.329			
Color Shift	Horizontal	$\theta_{\text{CST}_H}$	-	178	-	Degree
	Vertical	$\theta_{\text{CST}_V}$	-	178	-	Degree
Color gamut	CG	-	117.5	-	%	7
Viewing Angle (CR>10)						
General	Horizontal	$\theta_H$	170	178	-	Degree
	Vertical	$\theta_V$	170	178	-	Degree
Effective	Horizontal	$\theta_{\text{GMA}_H}$		178	-	Degree
	Vertical	$\theta_{\text{GMA}_V}$		178	-	Degree
Gray Scale				2.2		10

**Product Specification**

Notes 1. Contrast Ratio(CR) is defined mathematically as :

$$\text{Contrast Ratio} = \frac{\text{Surface Luminance with all white pixels}}{\text{Surface Luminance with all black pixels}}$$

It is measured at center point(Location P1)

2. Surface luminance(L<sub>WH</sub>)is luminance value at center point(P1) across the LCD surface 50cm from the surface with all pixels displaying white. For more information see FIG 2.

3. The variation in surface luminance , δ WHITE is defined as :

$$\delta_{\text{WHITE}} = \frac{\text{Minimum}(L_{\text{on1}}, L_{\text{on2}}, \dots, L_{\text{on9}})}{\text{Maximum}(L_{\text{on1}}, L_{\text{on2}}, \dots, L_{\text{on9}})} \times 100(\%)$$

Where L1 to L9 are the luminance with all pixels displaying white at 9 locations.  
For more information see FIG 2.

4. Response time is the time required for the display to transition from black to white (Rise Time, Tr<sub>R</sub>) and from white to black (Decay Time, Tr<sub>D</sub>). For additional information see FIG 3.

5. Gray to gray response time is the time required for the display to transition from gray to gray. For additional information see Table 10.

6. Color shift is the angle at which the color difference is lower than 0.04.  
For more information see FIG 4.

- Color difference (Δu'v')

$$u' = \frac{4x}{-2x+12y+3} \quad v' = \frac{9y}{-2x+12y+3}$$

$$\Delta u'v' = \sqrt{(u'_1 - u'_2)^2 + (v'_1 - v'_2)^2} \quad \begin{array}{l} u'_1, v'_1 : u'v' \text{ value at viewing angle direction} \\ u'_2, v'_2 : u'v' \text{ value at front } (\theta=0) \end{array}$$

- Pattern size : 25% Box size

- Viewing angle direction of color shift : Horizontal, Vertical

7, Color gamut is calculated from CIE1976.

8. Viewing angle is the angle at which the contrast ratio is greater than 10. The angles are determined for the horizontal or x axis and the vertical or y axis with respect to the z axis which is normal to the LCD surface. For more information see FIG 5.

9. Effective viewing angle is the angle at which the gamma shift of gray scale is lower than 0.3.  
For more information see FIG 6 and FIG 7.

10. Gray scale specification

Gamma Value is approximately 2.2. For more information see Table 11.

**Product Specification**

Measuring point for surface luminance & measuring point for luminance variation.

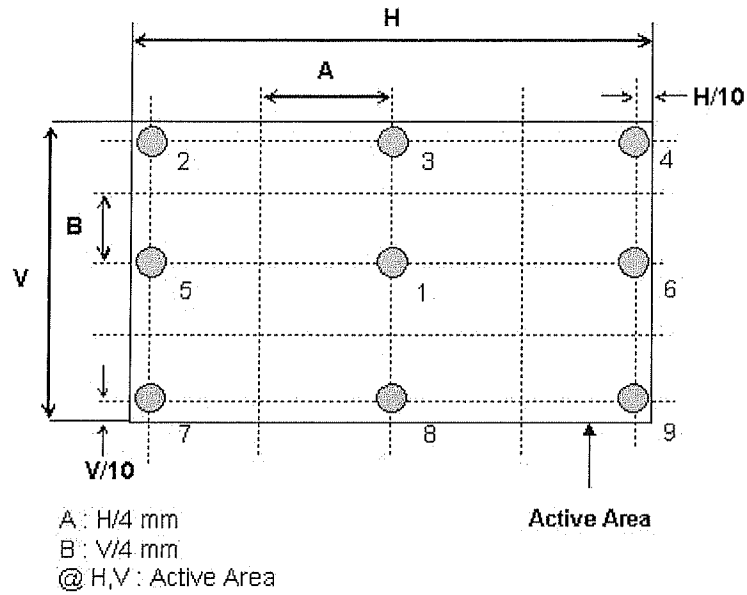

**FIG. 7 Measure Point for Luminance**

The response time is defined as the following figure and shall be measured by switching the input signal for "black" and "white".

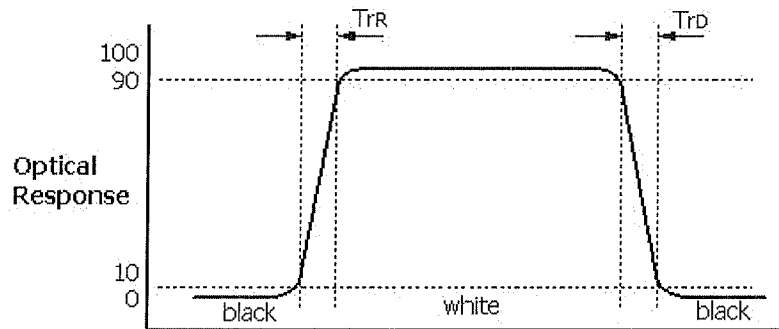

**FIG. 8 Response Time**

**Product Specification**

The gray to gray response time is defined as the following figure and shall be measured by switching the input signal for "Gray To Gray".

- Gray step : 5 step
- TGTG\_AVR is the total average time at rising time and falling time for "Gray To Gray".
- TGTG\_MAX is the max time at rising time or falling time for "Gray To Gray".

**Table 10. Gray to gray response time table**

Gray to Gray		Rising Time				
		G255	G191	G127	G63	G0
Falling Time	G255					
	G191					
	G127					
	G63					
	G0					

Color shift is defined as the following test pattern and color.

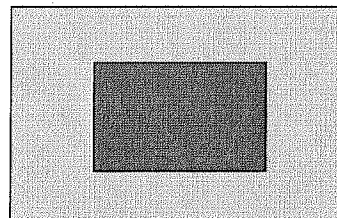

25% Box size

**FIG. 9 Test Pattern**

Average RGB values in Bruce RGB for Macbeth Chart

	Dark skin	Light skin	Blue sky	Foliage	Blue flower	Bluish green
R	98	206	85	77	129	114
G	56	142	112	102	118	199
B	45	123	161	46	185	178
	Orange	Purplish blue	Moderate red	Purple	Yellow green	Orange yellow
R	219	56	211	76	160	230
G	104	69	67	39	193	162
B	24	174	87	86	58	29
	Blue	Green	Red	Yellow	Magenta	Cyan
R	26	72	197	241	207	35
G	32	148	27	212	62	126
B	145	65	37	36	151	172
	White	Neutral 8	Neutral 6.5	Neutral 5	Neutral 3.5	black
R	240	206	155	110	63	22
G	240	206	155	110	63	22
B	240	206	155	110	63	22

Product Specification

Dimension of viewing angle.

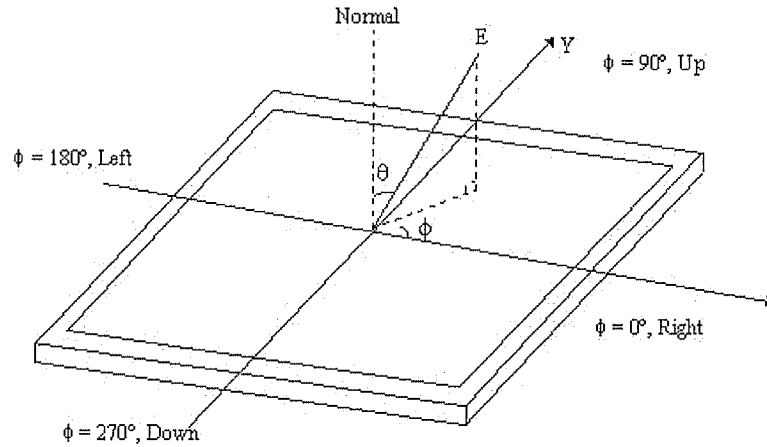

FIG. 10 Viewing angle

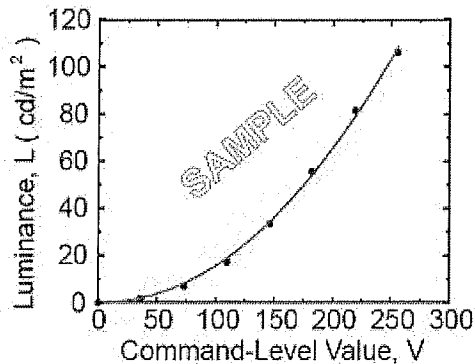

FIG. 11 Sample Luminance vs. gray scale (using a 256 bit gray scale)

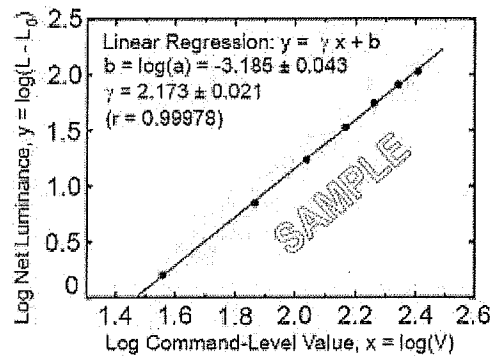

FIG. 12 Sample Log-log plot of luminance vs. gray scale

$$L = aV^\gamma + L_b$$

$$\log(L - L_b) = r \log(V) + \log(a)$$

Here the Parameter  $\alpha$  and  $\gamma$  relate the signal level  $V$  to the luminance  $L$ .  
The GAMMA we calculate from the log-log representation (FIG. 7)



**Product Specification**

**Table 11. Gray Scale Specification**

Gray Level	Relative Luminance [%] (Typ.)
0	0.1
31	1.2
63	4.7
95	11.7
127	21.2
159	35.2
191	53.0
223	75.4
255	100

**Product Specification**

**5. Mechanical Characteristics**

The contents provide general mechanical characteristics. In addition the figures in the next page are detailed mechanical drawing of the LCD.

Outline Dimension	Horizontal	582.0mm
	Vertical	375.6mm
	Depth	41.5mm
Bezel Area	Horizontal	554.1mm
	Vertical	347.8mm
Active Display Area	Horizontal	550.08mm
	Vertical	343.8mm
Weight	Typ : 3270 g , Max : 3400 g	
Surface Treatment	Hard coating(3H) Anti-glare treatment of the front polarizer	

Notes : Please refer to a mechanic drawing in terms of tolerance at the next page.

**Product Specification**

<FRONT VIEW>

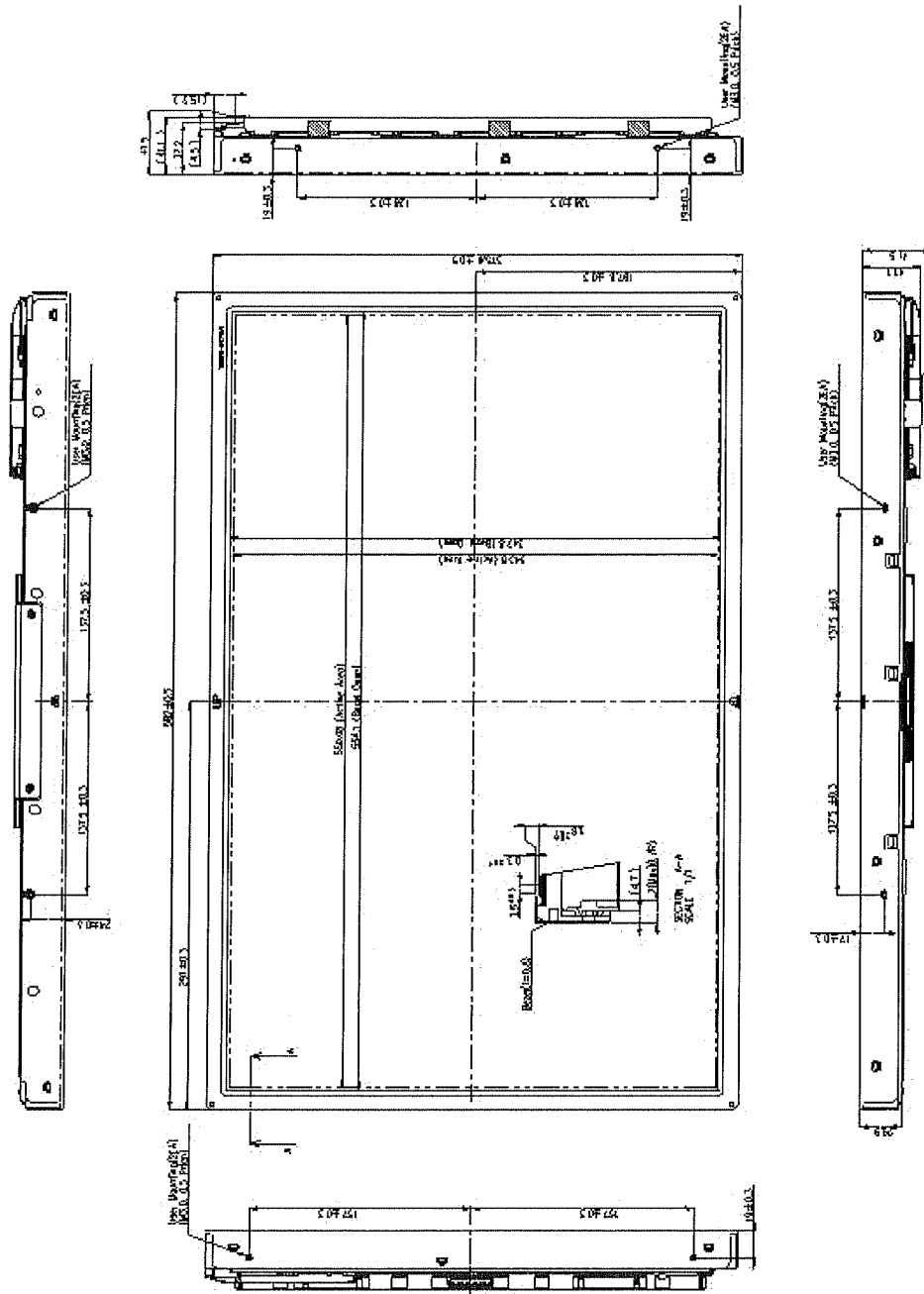

**Product Specification**

<REAR VIEW>

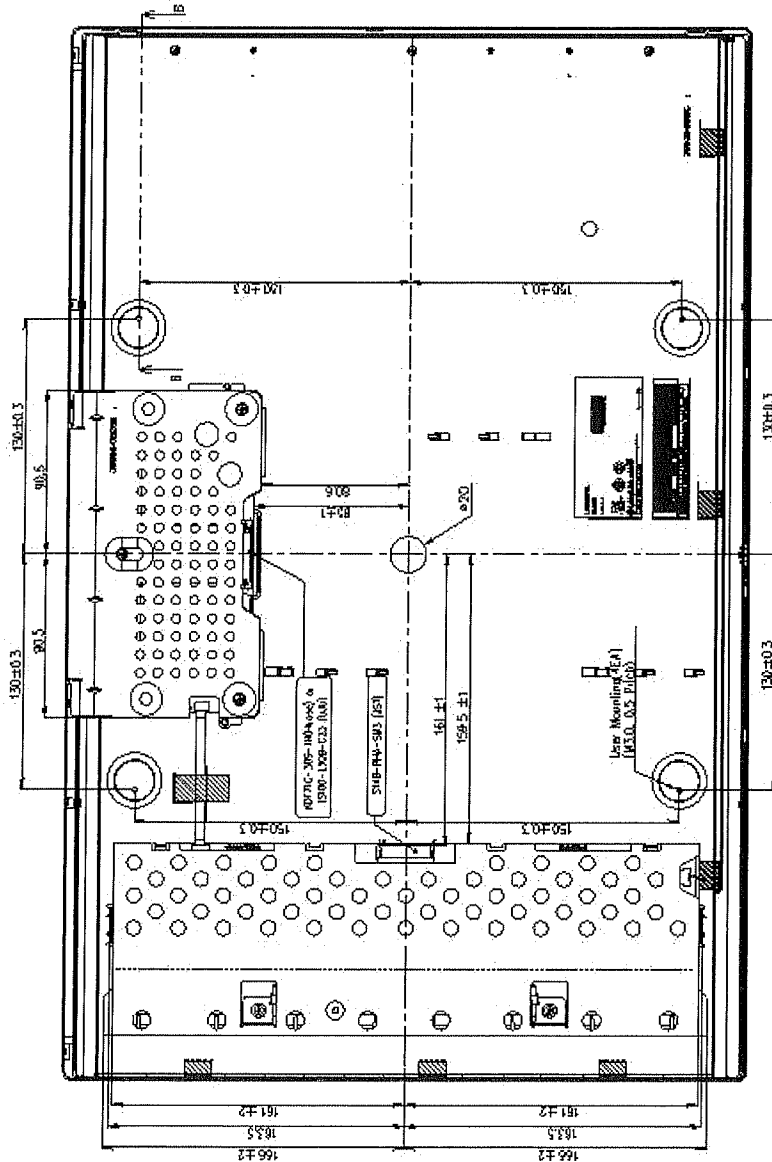

- Notes
1. Unspecified tolerances are to be ±0.5mm.
  2. Hll and portin disposition, tolerance of display area are as follows.
    - {1} V-direction B-FI ± 1.4mm
    - {2} X-direction C-FI ± 1.4mm

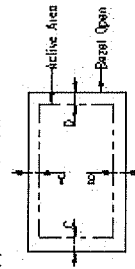

3. Torque SPEC of Mounting 6.0 ~ 7.0kgf cm

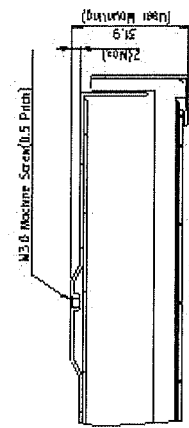

SECTION B-B  
SCALE 1/1

Product Specification

**6. Reliability**

Environment test condition

No	Test Item	Condition
1	High temperature storage test	Ta= 60°C 240h
2	Low temperature storage test	Ta= -20°C 240h
3	High temperature operation test	Ta= 50°C 50%RH 240h
4	Low temperature operation test	Ta= 0°C 240h
5	Vibration test (non-operating)	Wave form : random Vibration level : 1.47G RMS Bandwidth : 5-200Hz Duration : X,Y,Z, 33 min One time each direction
6	Shock test (non-operating)	Shock level : 100G Waveform : half sine wave, 2ms Direction : ±X, ±Y, ±Z One time each direction
7	Humidity condition Operation	Ta= 40 °C ,90%RH
8	Altitude storage / shipment	0 - 40,000 feet(12192m)
9	Maximum Storage Humidity for 4 corner light leakage Mura.	Max 70%RH , Ta=40°C

**Product Specification****7. International Standards****7-1. Safety**

- a) UL 60950-1:2003, First Edition, Underwriters Laboratories, Inc., Standard for Safety of Information Technology Equipment.
- b) CAN/CSA C22.2, No. 60950-1-03 1<sup>st</sup> Ed. April 1, 2003, Canadian Standards Association, Standard for Safety of Information Technology Equipment.
- c) EN 60950-1:2001, First Edition, European Committee for Electro technical Standardization(CENELEC) European Standard for Safety of Information Technology Equipment.

**7-2. EMC**

- a) ANSI C63.4 "Methods of Measurement of Radio-Noise Emissions from Low-Voltage Electrical and Electrical Equipment in the Range of 9kHz to 40GHz." American National Standards Institute(ANSI), 1992
- b) C.I.S.P.R. "Limits and Methods of Measurement of Radio Interface Characteristics of Information Technology Equipment." International Special Committee on Radio Interference.
- c) EN 55022 "Limits and Methods of Measurement of Radio Interface Characteristics of Information Technology Equipment." European Committee for Electro technical Standardization.(CENELEC), 1998 (Including A1: 2000 )

Product Specification

**8. Packing**

**8-1. Designation of Lot Mark**

a) Lot Mark

A	B	C	D	E	F	G	H	I	J	K	L	M
---	---	---	---	---	---	---	---	---	---	---	---	---

A,B,C : SIZE(INCH)  
E : MONTH

D : YEAR  
F ~ M : SERIAL NO.

Note

1. YEAR

Year	2001	2002	2003	2004	2005	2006	2007	2008	2009	2010
Mark	1	2	3	4	5	6	7	8	9	0

2. MONTH

Month	Jan	Feb	Mar	Apr	May	Jun	Jul	Aug	Sep	Oct	Nov	Dec
Mark	1	2	3	4	5	6	7	8	9	A	B	C

b) Location of Lot Mark

Serial No. is printed on the label. The label is attached to the backside of the LCD module.  
This is subject to change without prior notice.

**8-2. Packing Form**

a) Package quantity in one box : 5EA

b) Box Size : 452X376X660

**Product Specification****9. PRECAUTIONS**

Please pay attention to the followings when you use this TFT LCD module.

**9-1. MOUNTING PRECAUTIONS**

- (1) You must mount a module using holes arranged in four corners or four sides.
- (2) You should consider the mounting structure so that uneven force (ex. Twisted stress) is not applied to the module. And the case on which a module is mounted should have sufficient strength so that external force is not transmitted directly to the module.
- (3) Please attach the surface transparent protective plate to the surface in order to protect the polarizer. Transparent protective plate should have sufficient strength in order to resist external force.
- (4) You should adopt radiation structure to satisfy the temperature specification.
- (5) Acetic acid type and chlorine type materials for the cover case are not desirable because the former generates corrosive gas of attacking the polarizer at high temperature and the latter causes circuit break by electro-chemical reaction.
- (6) Do not touch, push or rub the exposed polarizers with glass, tweezers or anything harder than HB pencil lead. And please do not rub with dust clothes with chemical treatment. Do not touch the surface of polarizer for bare hand or greasy cloth. (Some cosmetics are detrimental to the polarizer.)
- (7) When the surface becomes dusty, please wipe gently with absorbent cotton or other soft materials like chamois soaks with petroleum benzene. Normal-hexane is recommended for cleaning the adhesives used to attach front / rear polarizers. Do not use acetone, toluene and alcohol because they cause chemical damage to the polarizer.
- (8) Wipe off saliva or water drops as soon as possible. Their long time contact with polarizer causes deformations and color fading.
- (9) Do not open the case because inside circuits do not have sufficient strength.

**9-2. OPERATING PRECAUTIONS**

- (1) The spike noise causes the mis-operation of circuits. It should be lower than following voltage :  
 $V = \pm 200\text{mV}$  (Over and under shoot voltage)
- (2) Response time depends on the temperature. (In lower temperature, it becomes longer.)
- (3) Brightness depends on the temperature. (In lower temperature, it becomes lower.)  
And in lower temperature, response time (required time that brightness is stable after turned on) becomes longer.
- (4) Be careful for condensation at sudden temperature change. Condensation makes damage to polarizer or electrical contacted parts. And after fading condensation, smear or spot will occur.
- (5) When fixed patterns are displayed for a long time, remnant image is likely to occur.
- (6) Module has high frequency circuits; Sufficient suppression to the electromagnetic interference shall be done by system manufacturers. Grounding and shielding methods may be important to minimize the interference.
- (7) Please do not give any mechanical and/or acoustical impact to LCM. Otherwise, LCM can't be operated its full characteristics perfectly.
- (8) A screw which is fastened up the steels should be a machine screw.  
(if not, it causes metallic foreign material and deal LCM a fatal blow)
- (9) Please do not set LCD on its edge.



**Product Specification****9-3. ELECTROSTATIC DISCHARGE CONTROL**

Since a module is composed of electronic circuits, it is not strong to electrostatic discharge. Make certain that treatment persons are connected to ground through wrist band etc. And don't touch interface pin directly.

**9-4. PRECAUTIONS FOR STRONG LIGHT EXPOSURE**

Strong light exposure causes degradation of polarizer and color filter.

**9-5. STORAGE**

When storing modules as spares for a long time, the following precautions are necessary.

- (1) Store them in a dark place. Do not expose the module to sunlight or fluorescent light. Keep the temperature between 5°C and 35°C at normal humidity.
- (2) The polarizer surface should not come in contact with any other object.  
It is recommended that they be stored in the container in which they were shipped.

**9-6. HANDLING PRECAUTIONS FOR PROTECTION FILM**

- (1) The protection film is attached to the bezel with a small masking tape.  
When the protection film is peeled off, static electricity is generated between the film and polarizer.  
This should be peeled off slowly and carefully by people who are electrically grounded and with well ion-blown equipment or in such a condition, etc.
- (2) When the module with protection film attached is stored for a long time, sometimes there remains a very small amount of glue still on the bezel after the protection film is peeled off.
- (3) You can remove the glue easily. When the glue remains on the bezel surface or its vestige is recognized, please wipe them off with absorbent cotton waste or other soft material like chamois soaked with normal-hexane.

Product Specification

Warranty for Non-Inclusion of Hazardous Substances  
in Products (ver.4.1)

Our company hereby warrants and guarantees that all of or part of products, including, but not limited to, the peripherals, accessories or (including your subsidiaries and affiliated company) directly or packages, manufactured and/ or delivered to your company indirectly by our company (including our subsidiaries or affiliated companies) are free from any of the substances listed in your company's Technology Standard or its subsequent revision; including the following articles,

1. Our company actually cooperates with environment-friendly policy pushed by your company and follows the total abolition schedule of Pb, Cd, Cr+6, Hg, PBB and PBDEs proposed by Hazardous substances management standard in your company
2. Our company don't excessively enclose to the noxious material including Cd, Pb in products and parts supporting to the department of DID in LG electronics. If the environmental accident is occurred by our company's mistake and insufficient improvement, acts on our company's responsibility
3. Our company ensure that all of information submitted to your company is not arbitrary estimation and is to the exact document based on reliable data.

By attached Data, Our company warrants this products confirm to following requirements.(Check each applicable item)

Pb Free Soldering     Pb Free     RoHS Free     TCO '03

Definition :

- Pb Free Soldering : Parts must meet DID's Heat resistance condition.  
(Reflow Type:250°C,10sec, Flow Type : 260°C,10sec)
- Pb Free : Lead wire plating is Pb Free(Pb content < 1,000ppm) and Inner contact point and Body itself don't contain Pb(Pb content < 1,000ppm)
- RoHS Free : Part does not contain Pb,Cd,Cr+6,Hg,PBBs and PBDEs(Cd<100ppm,Others<1,000ppm) and supplier must submit evidences(ICP,AAS,UV-Vis,GC) certificated by authorised agency
- TCO '03 : Part meet TCO'03 and LG electronics requirement  
(Cd<5ppm, Pb<50ppm, Hg<2ppm, Cr+6,PBBs,PBDEs<100)

Company name : *LG Philips LCD*  
Date : *Jan. 11. 2007*  
Representative : *Mun-Chaeal Jeung*  
Signature : *[Signature]*